

Pin Assignment

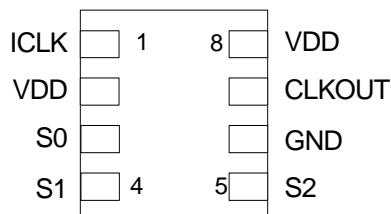

8-pin DFN

Spread Direction and Percentage Select Table

S2	S1	S0	Spread Direction	Spread Percentage
0	0	0	OFF	--
0	0	1	Center	± 0.25
0	1	0	Center	± 0.5
0	1	1	Center	± 1.0
1	0	0	Center	± 1.5
1	0	1	Center	± 2.0
1	1	0	Down	-0.5
1	1	1	Down	-1.0

Pin Description

Pin Number	Pin Name	Pin Type	Pin Description
1	ICLK	Input	Input clock.
2	VDD	Power	Voltage supply. Connect to 1.8 V ± 0.1 V, 2.5 V $\pm 10\%$ or 3.3 V $\pm 10\%$,
3	S0	Input	Function select 0 input. Selects spread amount and direction per table above. Internal pull-down resistor.
4	S1	Input	Function select 1 input. Selects spread amount and direction per table above. Internal pull-down resistor.
5	S2	Input	Function select 2 input. Selects spread amount and direction per table above. Internal pull-down resistor.
6	GND	Power	Connect to ground.
7	CLKOUT	Output	Clock output.
8	VDD	Power	Voltage supply. Connect to 1.8 V ± 0.1 V, 2.5 V $\pm 10\%$ or 3.3 V $\pm 10\%$

External Components

Decoupling Capacitor

As with any high-performance mixed-signal IC, the IDT5P50901/2/3/4 must be isolated from system power supply noise to perform optimally.

A decoupling capacitor of 0.01 μ F must be connected between each VDD and the PCB ground plane.

Series Termination Resistor

Clock output traces over one inch should use series termination. To series terminate a 50 Ω trace (a commonly used trace impedance), place a 33 Ω resistor in series with the clock line, as close to the clock output pin as possible. The nominal impedance of the clock output is 20 Ω .

External Clock Input

This device operates from an external clock input and as such does not have a on chip oscillator circuit.

Spread Spectrum Profile

The IDT5P50901/2/3/4 is a low EMI clock generator using an optimized frequency slew rate algorithm to facilitate down stream tracking of zero delay buffers and other PLL devices.

The modulation rate is directly relate to the input clock frequency.

For input frequency ICLK, then use the modulation frequency indicated for the part below.

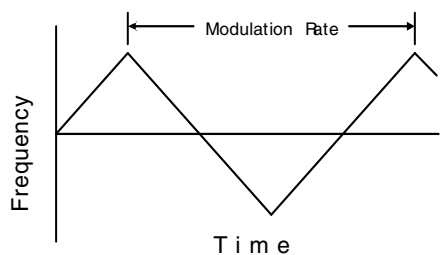

PCB Layout Recommendations

For optimum device performance and lowest output phase noise, the following guidelines should be observed.

- 1) The 0.01 μ F decoupling capacitors should be mounted on the component side of the board as close to the VDD pin as possible. No vias should be used between the decoupling capacitors and VDD pins. The PCB trace to VDD pins should be kept as short as possible, as should the PCB trace to the ground via.
- 2) To minimize EMI, the 33 Ω series termination resistor (if needed) should be placed close to the clock output.
- 3) An optimum layout is one with all components on the same side of the board, minimizing vias through other signal layers. Other signal traces should be routed away from the IDT5P50901/2/3/4. This includes signal traces just underneath the device, or on layers adjacent to the ground plane layer used by the device.

Absolute Maximum Ratings

Stresses above the ratings listed below can cause permanent damage to the IDT5P50901/2/3/4. These ratings, which are standard values for IDT commercially rated parts, are stress ratings only. Functional operation of the device at these or any other conditions above those indicated in the operational sections of the specifications is not implied. Exposure to absolute maximum rating conditions for extended periods can affect product reliability. Electrical parameters are guaranteed only over the recommended operating temperature range.

Item	Rating
Supply Voltage, VDD	-0.5 V to 5.0 V
All Inputs	-0.5 V to VDD +0.5 V
Ambient Operating Temperature	-40 to +85° C
Storage Temperature	-50 to +150° C
Junction Temperature	125° C
Soldering Temperature	260° C

Recommended Operation Conditions

Parameter	Min.	Typ.	Max.	Units
Ambient Operating Temperature	-40		+85	°C
Power Supply Voltage VDD (measured in respect to GND)	+1.7	+1.8	+1.9	V
	+2.25	+2.5	+2.75	V
	+2.97	+3.3	+3.63	V

DC Electrical Characteristics

Unless stated otherwise, **VDD = 1.8 V ±0.1 V**. Ambient Temperature -40 to +85°C

Parameter	Symbol	Conditions	Min.	Typ.	Max.	Units
Operating Voltage	VDD		1.7	1.8	1.9	V
Input High Voltage	V _{IH}	ICLK, S2:S0	VDD x 0.8		VDD + 0.3	V
Input Low Voltage	V _{IL}	ICLK, S2:S0	GND		VDD x 0.2	V
Output High Voltage	V _{OH}	I _{OH} = -12 mA	VDD x 0.75	VDD		V
Output Low Voltage	V _{OL}	I _{OL} = 12 mA		GND	VDD x 0.25	V
IDD		No load	See table page 6			
Input Capacitance				5		pF
Load Capacitance				5		pF
Internal Pull-down Resistor	R _{PD}	S1:S0		200	260	kΩ

Unless stated otherwise, **VDD = 2.5 V ±10%**. Ambient Temperature -40 to +85°C

Parameter	Symbol	Conditions	Min.	Typ.	Max.	Units
Operating Voltage	VDD		2.25	2.5	2.75	V
Input High Voltage	V _{IH}	ICLK, S2:S0	VDD x 0.8		VDD + 0.3	V
Input Low Voltage	V _{IL}	ICLK, S2:S0	GND		VDD x 0.2	V
Output High Voltage	V _{OH}	I _{OH} = -25 mA	VDD x 0.9	VDD		V
Output Low Voltage	V _{OL}	I _{OL} = 25 mA		GND	VDD x 0.1	V
IDD		No load	See table page 6			
Input Capacitance				5		pF
Load Capacitance				5		pF
Internal Pull-down Resistor	R _{PD}	S1:S0		200	260	kΩ

Unless stated otherwise, **VDD = 3.3 V ±10%**. Ambient Temperature -40 to +85°C

Parameter	Symbol	Conditions	Min.	Typ.	Max.	Units
Operating Voltage	VDD		2.97	3.3	3.63	V
Input High Voltage	V _{IH}	ICLK, S2:S0	VDD x 0.8		VDD + 0.3	V
Input Low Voltage	V _{IL}	ICLK, S2:S0	GND		VDD x 0.2	V
Output High Voltage	V _{OH}	I _{OH} = -33 mA	VDD x 0.9	VDD		V
Output Low Voltage	V _{OL}	I _{OL} = 33 mA		GND	VDD x 0.1	V
IDD		No load	See table page 6			
Input Capacitance				5		pF
Load Capacitance				5		pF
Internal Pull-down Resistor	R _{PD}	S1:S0		200	260	kΩ

Operational IDD

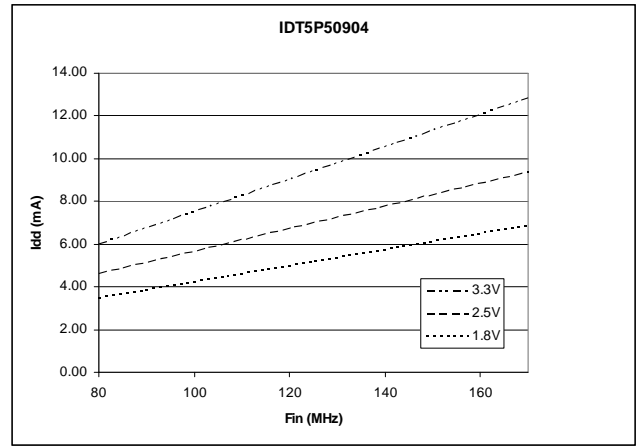
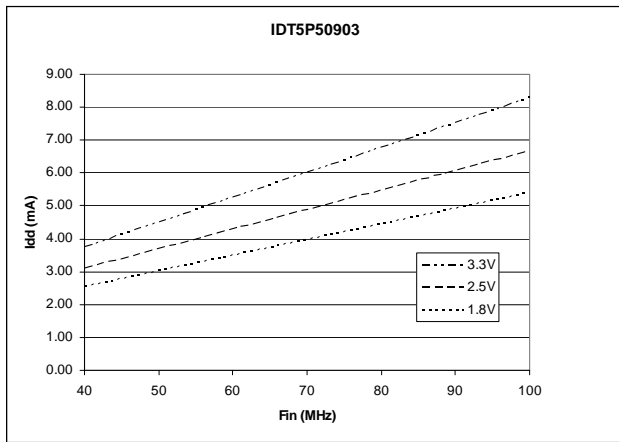
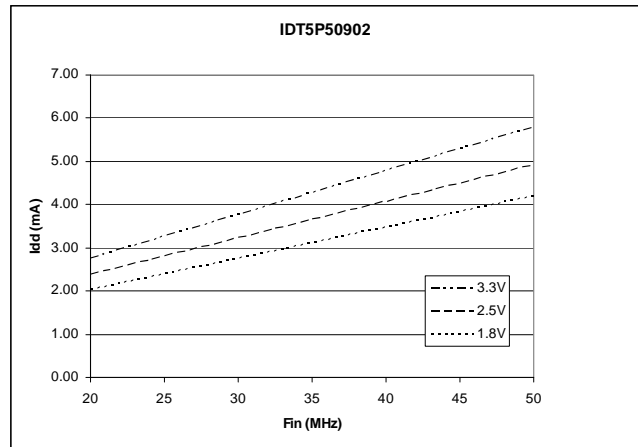
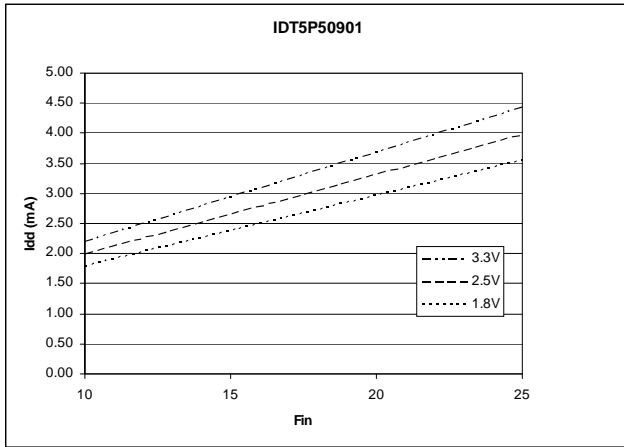

AC Electrical Characteristics

Unless stated otherwise, VDD = 1.8 V ±0.1 V, 2.5 V ±10% or 3.3 V ±10%. Ambient Temperature -40 to +85°C

Parameter	Symbol	Conditions	Min.	Typ.	Max.	Units
Output Clock Duty Cycle			45	50	55	%
		1.8V ±0.1V, >130MHz	40	50	60	
Output Rise Time	t _{OR}	20% to 80%, Note 1		1.2		ns
Output Fall Time	t _{OF}	80% to 20%, Note 1		1.2		ns
Spread Spectrum Modulation Rate		10 to 25 MHz input (IDT5P50901)	27		67.5	kHz
		20 to 50 MHz input (IDT5P50902)	27		67.5	kHz
		40 to 100 MHz input (IDT5P50903)	27		67.5	kHz
		80 to 170 MHz input (IDT5P50904)	27		57.3	kHz
Jitter Cycle to Cycle		Cycle to cycle jitter		150		ps
Output Settling Time		Note 2			3.0	ms

Note 1: Measured with 5 pF load

Note 2: Time between VDD rising above minimum operating voltage and stable frequency output

Package Outline and Package Dimensions (8-pin DFN 2x2mm, 0.5mm pitch)

Package dimensions are kept current with JEDEC Publication No. 95,



Symbol	Millimeters	
	Min	Max
A	0.80	1.00
A1	0	0.05
A3	0.20 Reference	
b	0.20	0.30
N	8	
N _D	4	
N _E	0	
D	2.00 BASIC	
E	2.00 BASIC	
e	0.50 BASIC	
D2	1.05	1.25
E2	0.45	0.65
L	0.20	0.40
aaa	0.15	
bbb	0.10	
ccc	0.10	

Marking Diagram (8DFN)



Notes:

1. #### is the last four numbers of the lot number.
2. Dot indicates pin 1.
3. "G" designates Pb (lead) free package.

Package Outline and Package Dimensions (8-pin MSOP, 3.00 mm Body)

Package dimensions are kept current with JEDEC Publication No. 95

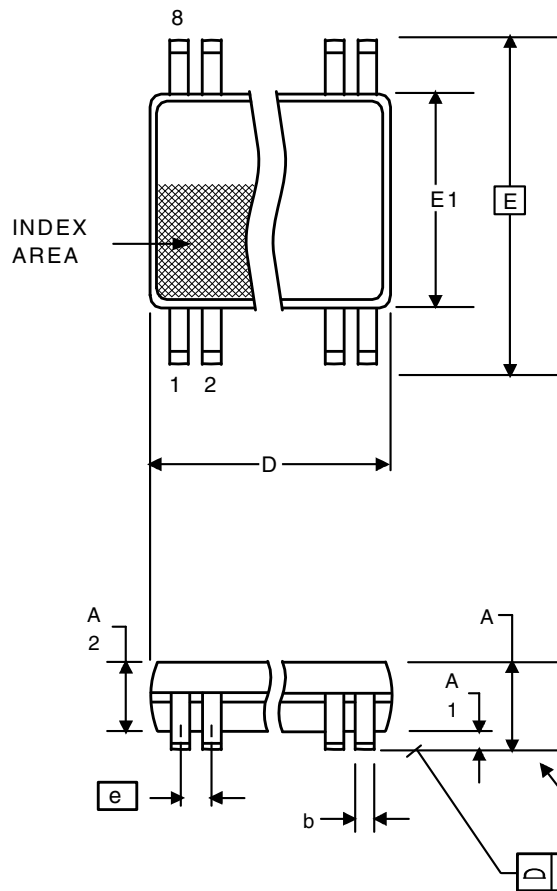

Symbol	Millimeters		Inches*	
	Min	Max	Min	Max
A	--	1.10	--	0.043
A1	0	0.15	0	0.006
A2	0.79	0.97	0.031	0.038
b	0.22	0.38	0.008	0.015
C	0.08	0.23	0.003	0.009
D	3.00 BASIC		0.118 BASIC	
E	4.90 BASIC		0.193 BASIC	
E1	3.00 BASIC		0.118 BASIC	
e	0.65 Basic		0.0256 Basic	
L	0.40	0.80	0.016	0.032
α	0°	8°	0°	8°
aaa	-	0.10	-	0.004

*For reference only. Controlling dimensions in mm.

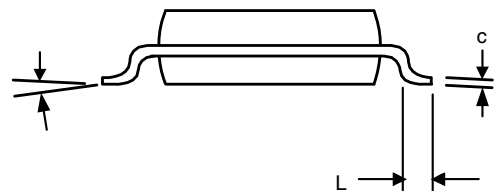

Marking Diagram (8 MSOP)

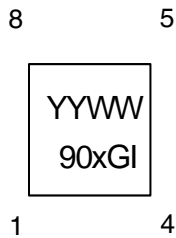

Notes:

1. YYWW is the assembly date code.
2. Dot indicates pin 1.
3. "G" designates Pb (lead) free package.
4. "I" designates industrial temperature range.

Ordering Information

Part / Order Number	Marking	Shipping Packaging	Package	Temperature
5P50901NBDG18	see pages 7,8	Tape and Reel	8-pin DFN	-40° C to +85° C
5P50901DVG1		Tube	8-pin MSOP	-40° C to +85° C
5P50901DVG18		Tape and Reel	8-pin MSOP	-40° C to +85° C
5P50902NBDG18		Tape and Reel	8-pin DFN	-40° C to +85° C
5P50902DVG1		Tube	8-pin MSOP	-40° C to +85° C
5P50902DVG18		Tape and Reel	8-pin MSOP	-40° C to +85° C
5P50903NBDG18		Tape and Reel	8-pin DFN	-40° C to +85° C
5P50903DVG1		Tube	8-pin MSOP	-40° C to +85° C
5P50903DVG18		Tape and Reel	8-pin MSOP	-40° C to +85° C
5P50904NBDG18		Tape and Reel	8-pin DFN	-40° C to +85° C
5P50904DVG1		Tube	8-pin MSOP	-40° C to +85° C
5P50904DVG18		Tape and Reel	8-pin MSOP	-40° C to +85° C

"G" after the two-letter package code denotes Pb-Free configuration, RoHS compliant.

While the information presented herein has been checked for both accuracy and reliability, Integrated Device Technology (IDT) assumes no responsibility for either its use or for the infringement of any patents or other rights of third parties, which would result from its use. No other circuits, patents, or licenses are implied. This product is intended for use in normal commercial applications. Any other applications such as those requiring extended temperature range, high reliability, or other extraordinary environmental requirements are not recommended without additional processing by IDT. IDT reserves the right to change any circuitry or specifications without notice. IDT does not authorize or warrant any IDT product for use in life support devices or critical medical instruments.

Revision History

Rev.	Date	Originator	Description of Change
A	6/28/11	R. Willner	Initial release.
B	6/30/11	R. Willner	Correct modulation rate on 5P50904, rise/fall time definition.
C	07/29/11	R. Willner	Added "Internal Pull-down Resistor" spec to DC char tables
D	10/07/11	R. Willner	Correct typographical errors.
E	05/14/12	R. Willner	Changed max Supply Voltage VDD rating from 7.0V to 5.0V
F	08/21/12	R. Willner	1. Changed "Output High/Low Voltage" specs; conditions and min/max values for 1.8V DC electrical characteristics 2. Added an additional line for "Output Clock Duty Cycle" in AC char table to include conditions and values for 1.8V

