

7/16
50Ω

ATTENUATOR PLUG/JACK

60AS105-K06N1

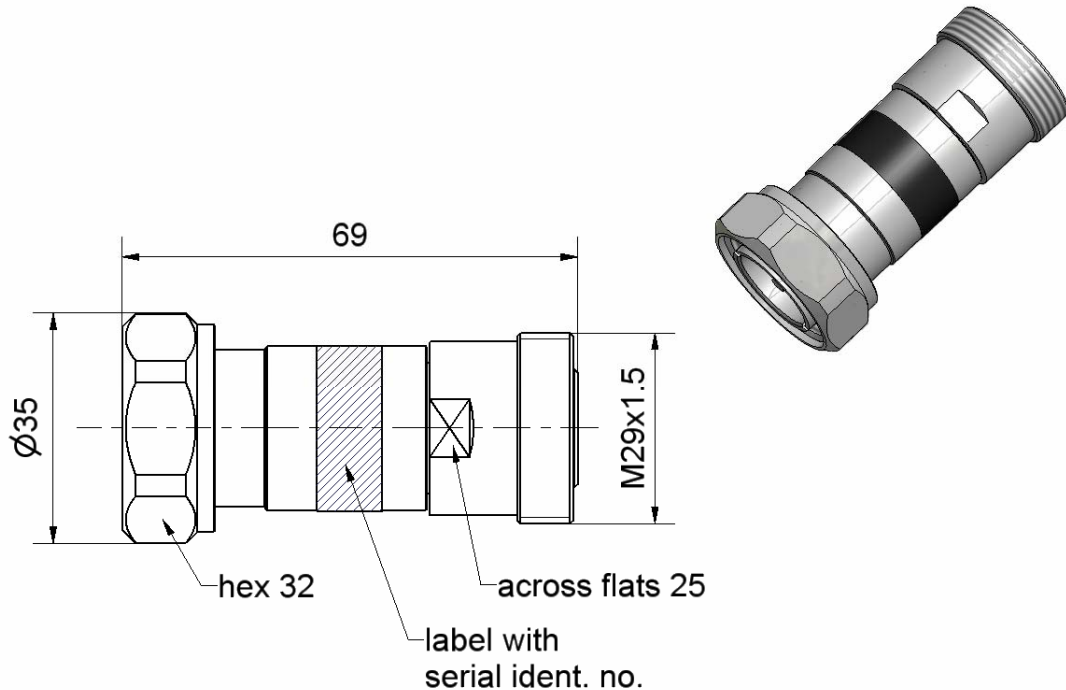

All dimensions are in mm; tolerances according to ISO 2768 m-H

Interface

According to IEC 60169-4, VG 95250, EN 122190, DIN 47223

Documents

N/A

Material and plating

Connector parts

Center contact - plug
Center contact - jack
Outer contact
Body
Coupling nut
Dielectric
Substrate

Material

Brass
Beryllium copper
Brass
Brass
Brass
PPE
ALN

Plating

Silver, 3-6 µm
Silver, 3-6 µm
Flash white bronze over silver(e.g. Optargen®)
Flash white bronze over silver(e.g. Optargen®)
Flash white bronze over silver(e.g. Optargen®)

7/16
50Ω

ATTENUATOR PLUG/JACK

60AS105-K06N1

Electrical data

Impedance 50 Ω
 Frequency DC to 8 GHz
 Return loss ≥ 30.7 dB, DC to 1 GHz
 ≥ 26.4 dB, 1 GHz to 2 GHz
 ≥ 20.0 dB, 2 GHz to 8 GHz
 Attenuation 6 dB
 Tolerances ≤ ± 0.3 dB, DC to 2 GHz
 ≤ ± 0.4 dB, 2 GHz to 4 GHz
 ≤ ± 0.8 dB, 4 GHz to 8 GHz
 Center contact resistance ≤ 4.0 mΩ
 Outer contact resistance ≤ 1.5 mΩ
 Power handling 5 W at 25°C
 derated linearity to 0 Watts at 125°C

Mechanical data

Mating cycles min. 500
 Coupling nut retention ≥ 1000 N
 Center contact captivation ≥ 200 N
 Coupling test torque max. 35 Nm
 Recommended torque 25 Nm to 30 Nm

Environmental data

Temperature range -65°C to +85°C
 2002/95/EC (RoHS) compliant

Tooling

N/A

Suitable cables

N/A

Packing

Standard 1 pce in bag
 Weight 222 g/pce

While the information has been carefully compiled to the best of our knowledge, nothing is intended as representation or warranty on our part and no statement herein shall be construed as recommendation to infringe existing patents. In the effort to improve our products, we reserve the right to make changes judged to be necessary.

Draft	Date	Approved	Date	Rev.	Engineering change number	Name	Date
Kerstin Herzog	23/03/05	Frank Weiß	10/06/08	d00	08-0348	Kerstin Hobrak	11/06/08
Rosenberger Hochfrequenztechnik GmbH & Co. KG P.O.Box 1260 D-84526 Tittmoning Germany www.rosenberger.de					Tel.: +49 8684 18-0 Fax: +49 8684 18-499 email: info@rosenberger.de		Page 2 / 2