

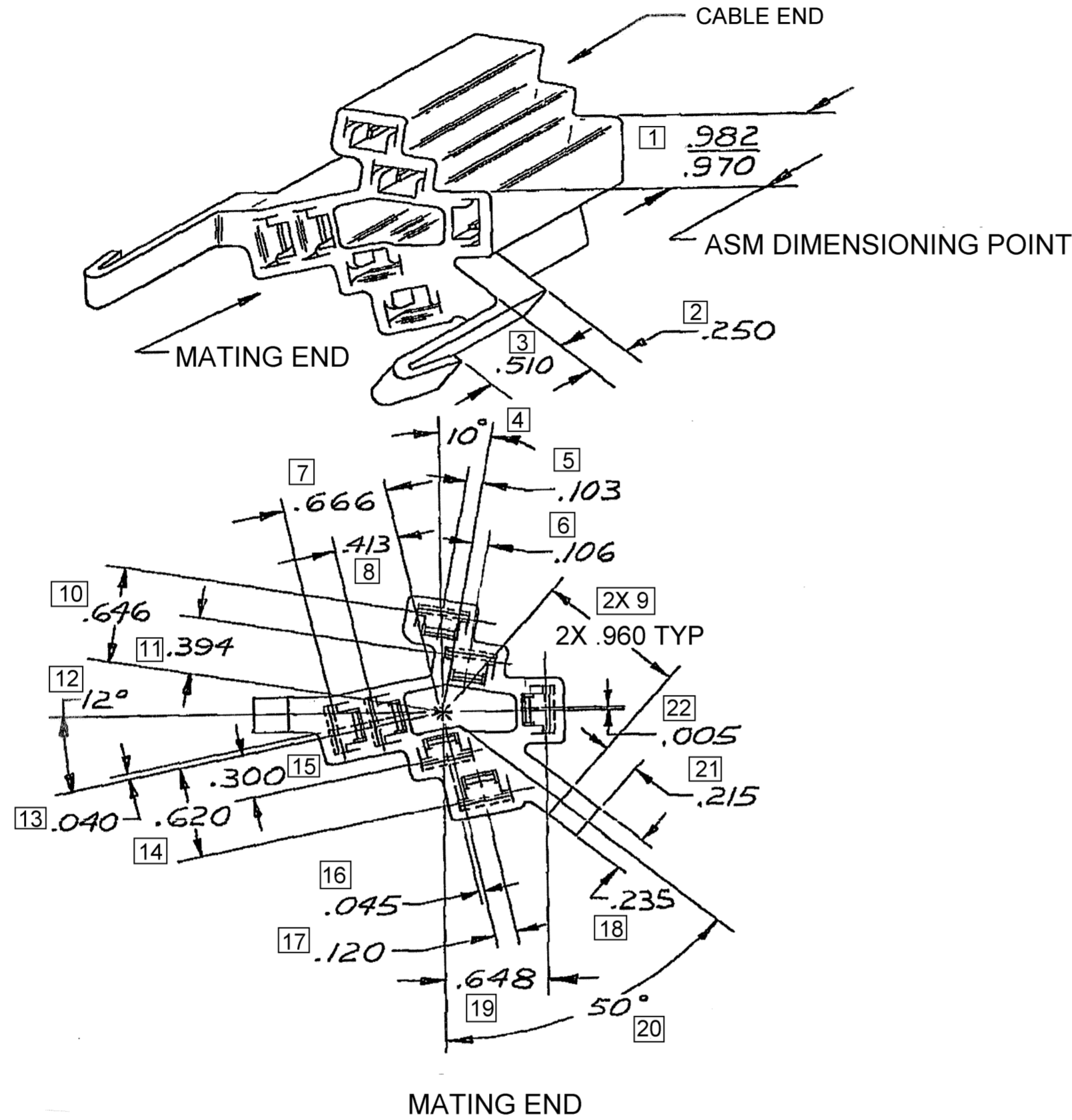

SYMBOL DEFINITION		MISSING NUMBERS
A DIMENSION WITHOUT AN INSPECTION REPORT SYMBOL  DOES NOT REQUIRE INSPECTION. IT MAY BE CONTROLLED ON AN INDIVIDUAL COMPONENT DRAWING.	TOTAL NO. OF SYMBOLS ON DRAWING	23
	LAST NO. USED	22





DWG STATUS					ZONE	REVISION HISTORY	AUTH	DR	APVD 1	APVD 2
DATE	STG	REV	N/P	CHG						
10AP87	R	-	-	-		REVISED NAME	112905	JC	TM	
11AU04	R	02	-	-		REVISED NOTES AND MAT'L SPEC WAS R-61354	257180	TLD	TLD	ET



NOTES

- UNLESS OTHERWISE SPECIFIED AND/OR INDICATED: DIMENSIONS ARE TO FACE OF VIEW SHOWN AND AUTOMATICALLY ROUNDED BY COMPUTER FOR INSPECTION (SEE MATH MODEL FOR PRECISE DIMENSIONS). FOR ALL OTHER DIMENSIONS NOT SHOWN BUT REQUIRED FOR TOOL BUILD, SEE MATH MODEL FOR PRECISE TOOL PATH DATA.
- MATERIAL RECYCLING CODE PER SAE J1344. (.08)X(.004) RAISED CHARACTERS AS SHOWN TO BE LOCATED ON ANY EXTERIOR SURFACE. OPTIONAL CONSTRUCTION TO BE NO MATERIAL RECYCLING CODE.
- (.08)X(.004) RAISED DELPHI CORPORATE BRAND TO BE LOCATED ON ANY EXTERIOR SURFACE, PREFERABLY VISIBLE AT FINAL ASSEMBLY. OPTIONAL CONSTRUCTION TO BE "PED" OR NO LOGO.

 PROCESS SENSITIVE DIMENSION
DIMENSIONS ENCLOSED IN () INDICATE REFERENCE DIMENSIONS AND NO TOLERANCE LIMITS ARE ESTABLISHED
TOLERANCE UNLESS OTHERWISE SPECIFIED
DECIMAL ±.005
FRACTIONAL ±
ANGULAR ±2°

DWG TYPE		PART DRAWING	
STYLE			
VOLUME (CM ³)	DISTR CODE 		
UNLESS OTHERWISE SPECIFIED			
THIS DOCUMENT IS IN ACCORDANCE WITH ASME Y14.5M-1994 AS AMENDED BY THE GM GLOBAL DIMENSIONING AND TOLERANCING ADDENDUM-2001. SEPARATE PATTERNS OF FEATURES MAY BE GAGED SEPARATELY REGARDLESS OF DATUM REFERENCES.			
ALL DIMENSIONS ARE IN INCHES			
REFERENCE			
THIRD ANGLE PROJECTION	DO NOT SCALE		
		USE MATH DATA	

DELPHI

DELPHI PACKARD ELECTRIC SYSTEMS
WARREN, OH

DR	DATE					
APVD1 TOM MUDREY	27SE66					
APVD2 DON THIRY	27SE66					
APVD3 E.R. MASAS	27SE66					
APVD4						
APVD5						
SUBSTANCES OF CONCERN AND RECYCLED CONTENT PER DELPHI 10949001						
MATERIAL M2097001 PP 1M BLK						
DRAWING NAME CONN 7 F 56 BLK						
DRAWING NUMBER 06288702						
SIZE A2	SCALE NONE	FRAME NO 1 OF 1	SHEET NO 1 OF 1	STG R	REV 02	N/P -

User: GZVUS4 Part: 06288702-CUS01-S01 Date: 10-Aug-04 Time: 07:59 Message: "