



Optical Encoders

SERIES 62S Compact 1/2" Package

FEATURES

- Compact Size
- Requires Minimal Behind Panel Space
- 1 Million Rotational Cycles for Low and Medium Torque, 1/2 Million for High
- 3 Million Rotations for Non-Detent Styles
- Optional Integral Pushbutton
- Choices of Cable Length and Terminations

APPLICATIONS

- Global Positioning/Driver Information Systems
- Medical Equipment

RECOMMENDED PANEL CUTOUT

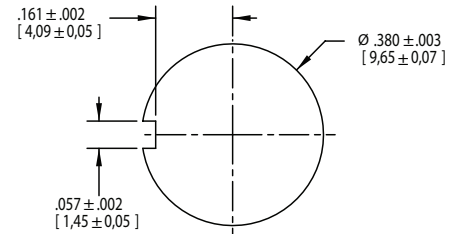

DIMENSIONS in inches (and millimeters)

Unless otherwise specified, standard tolerance is ± 0.10 (0,25)



CIRCUITRY, TRUTH TABLE, AND WAVEFORM Standard Quadrature 2-Bit Code

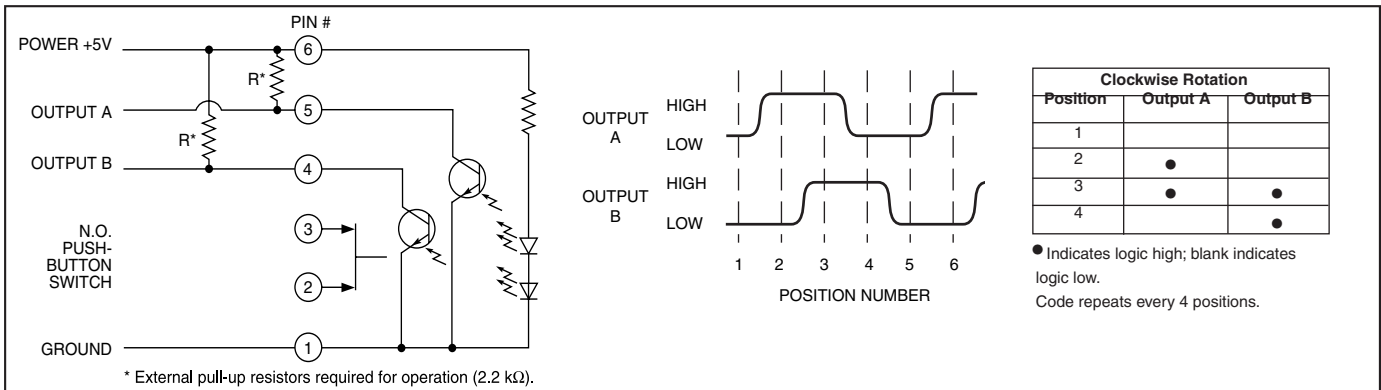

SPECIFICATIONS

Environmental Specifications

- Operating Temp. Range:** -40°C to 85°C
- Storage Temp. Range:** -55°C to 100°C
- Humidity:** 96 Hours at 90–95% humidity at 40°C
- Mechanical Vibration:** Harmonic motion with amplitude of 15G's, within a varied frequency of 10 to 2000 Hz
- Mechanical Shock:** Test 1: 100G for 6 mS, half sine wave with a velocity change of 12.3 ft/s; Test 2: 100G for 6 mS, sawtooth wave with a velocity change of 9.7 ft/s

Rotary Electrical and Mechanical Specifications

- Operating Voltage:** 5.00 ±0.25 Vdc
 - Supply Current:** 25mA max at 5.25Vdc
 - Output:** Open collector phototransistor, external pull up resistors are required
 - Output Code:** 2-Bit quadrature, channel A leads channel B by 90° electrically during clockwise rotation of the shaft
 - Logic Output Characteristics:** Logic High shall be no less than 3.8 Vdc
Logic Low shall be no greater than 0.8Vdc
 - Minimum Sink Current:** 2.0 mA
 - Power Consumption:** 132mW maximum (includes power in 2 pull-up resistors)
 - Mechanical Life:**
 - Non-Detent 3 Million Cycles
 - Low & Medium 1 Million Cycles
 - High 1/2 Million Cycles
- 1 cycle is a rotation through all positions and a full return

	LOW	MEDIUM	HIGH
	±0.50 IN-OZ	±1.40 IN-OZ	±1.60 IN-OZ
8 POSITION	1.10	1.85	2.75
12 POSITION	1.00	1.70	2.95
16 POSITION	1.40	2.35	3.40
20 POSITION	1.35	2.05	2.80
24 POSITION	1.25	1.95	2.95
32 POSITION	0.95	1.40	2.15

- Torque shall be within 50% of initial value throughout life
- Mounting Torque:** 15 in-lbs maximum
- Shaft Push-Out Force:** 45 lbs minimum
- Shaft Pull-Out Force:** 45 lbs minimum
- Terminal Strength:** 15 lbs minimum terminal pull-out force for cable or header termination
- Solderability:** 95% free of pin holes and voids

Pushbutton Electrical & Mechanical Specifications

- Rating:** 10 mA at 5 Vdc
- Contact Resistance:** <10Ω
- Life:** 3 million actuations minimum
- Contact Bounce:** <4 ms Make, <10 ms Break
- Actuation Force:** 9-950±150grams, 5-510±150 grams, 4-400±100 grams, 3-300±90 grams, 2-200±75 grams
- Shaft Travel:** .025±.010 inch

Materials and Finishes

- Bushing:** Zamak 2
- Shaft:** Aluminum or Zamak 2
- Retaining Ring:** Stainless steel
- Pushbutton Actuator:** Zytel 70G33L
- Detent Spring:** Music wire
- Detent Ball:** Stainless steel

Code Housing: Polyamide polymer, nylon 6/10 alloy UL94HB

Code Rotor: Delrin 100

Printed Circuit Boards: NEMA grade FR-4, double clad with copper, plated with gold over nickel

Infrared Emitting Diode Chips: Gallium aluminum arsenide

Silicon Phototransistor Chips: Gold and Aluminum Alloys

Resistor: Metal oxide on ceramic substrate

Solder Pins: Brass, plated with tin

Pushbutton Dome: Stainless steel

Backplate: Stainless steel

Cable: Copper stranded with topcoat in PVC insulation (Cable version only)

Connector (.050 Center): PA4.6 with tin over nickel plated phosphor bronze

Connector (.100 Center): Nylon UL94V-2, tin plated copper alloy

Label: TT406 Thermal transfer cast film

Solder: Sn/Ag/Cu, Lead-Free, No Clean

Lubricating Grease: NYE nyogel 774L

Hex Nut: Nickel, plated with brass

Lockwasher: Zinc Plated Spring Steel with Clear Trivalent Chromate Finish

Header: Hi-Temp glass filled thermoplastic UL94V-0, phosphor bronze (pin versions only)

Strain Relief: Glass filled thermoplastic (.100 center cable versions only)

OPTIONS

Contact Grayhill for custom terminations, shaft and bushing configurations, rotational torque pushbutton force, and code output.

ORDERING INFORMATION

Angle of Throw

- 45=45° for Code Change and 8 Detent Positions
- 30=30° for Code Change and 12 Detent Positions
- 22=22.5° for Code Change and 16 Detent Positions
- 18=18° for Code Change and 20 Detent Positions
- 15=15° for Code Change and 24 Detent Positions
- 11=11.25° for Code Change and 32 Detent Positions

Rotational Torque Option

- N = Non-detent
- L = Low Torque (available with 0, 4, 5, 9 pushbutton only)
- M = Medium Torque (available with 0, 5, 9 pushbutton only)
- H = High Torque (available with 0, 9 pushbutton only)

Termination

- C = .050 Center Ribbon Cable with Connector
- S = .050 Center Ribbon Cable with .100 Stripped End
- P = .050 Center Pins with .130 Length
- CH = .100 Center Ribbon Cable with Connector
- SH = .100 Center Ribbon Cable with .100 Stripped End
- PH = .100 Center Pins with .230 Length

Cable Length

Cable Termination: 040=4.0in or 040in. Cable is terminated with Amp Connector P/N 3-640442-6 See Amp Mateability Guide for mating connector details.

Pushbutton Option

- 0 = NO PUSHBUTTON
- 9 = 950 Grams
- 5 = 510 Grams
- 4 = 400 Grams
- 3 = 300 Grams
- 2 = 200 Grams

62SXX-XX-040X