

**SERIES 62S**  
Compact 1/2" Package

**FEATURES**

- Compact Size, Requires Minimal Behind Panel Space
- 1 Million Rotational Cycles, 3 Million for Non-Detent Styles
- Optional Integral Pushbutton
- Choices of Cable Length and Terminations

**APPLICATIONS**

- Global Positioning/Driver Information Systems
- Medical Equipment



**DIMENSIONS** In inches (and millimeters)

Unless otherwise specified, standard tolerance is  $\pm 0.010$  (0,25)

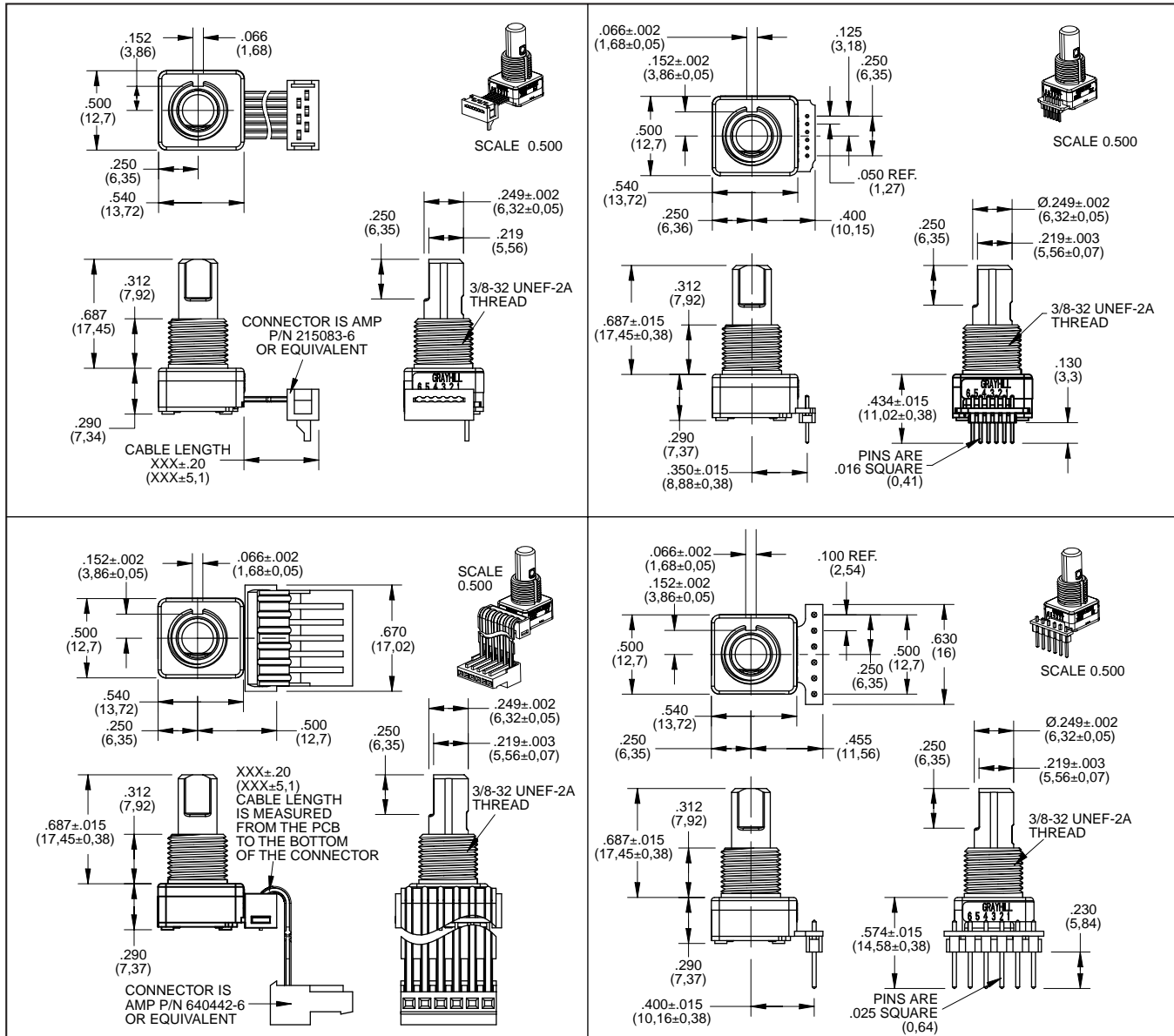

Optical and Mechanical Encoders

## CIRCUITRY, TRUTH TABLE, AND WAVEFORM Standard Quadrature 2-Bit Code

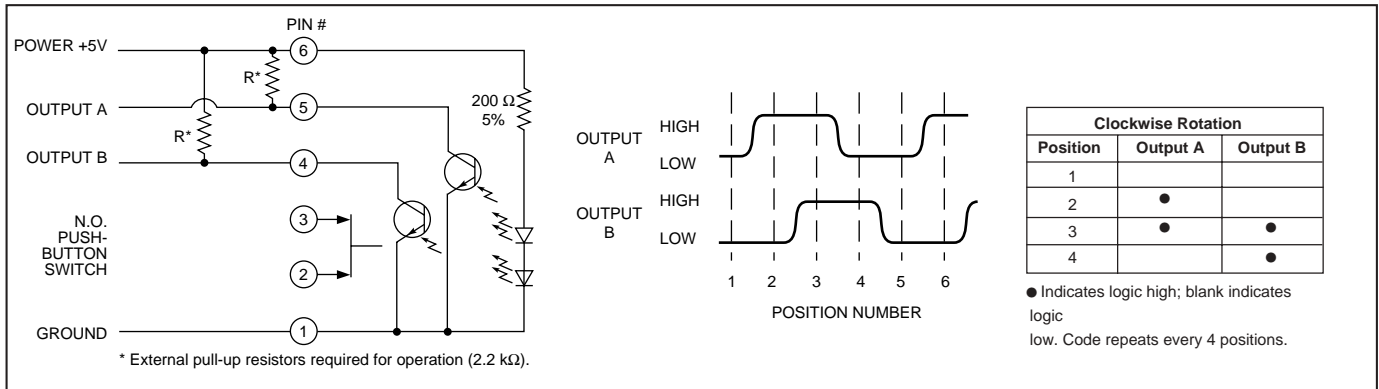

### SPECIFICATIONS

#### Environmental Specifications

**Operating Temperature Range:** -40°C to 85°C  
**Storage Temperature Range:** -55°C to 100°C  
**Humidity:** 96 Hours at 90–95% humidity at 40°C  
**Mechanical Vibration:** Harmonic motion with amplitude of 15G's, within a varied frequency of 10 to 2000 Hz  
**Mechanical Shock:** Test 1: 100G for 6 mS, half sine wave with a velocity change of 12.3 ft/s; Test 2: 100G for 6 mS, sawtooth wave with a velocity change of 9.7 ft/s

#### Rotary Electrical and Mechanical Specifications

**Operating Voltage:** 5.00 ±0.25 Vdc  
**Supply Current:** 30mA maximum at 5Vdc  
**Output:** Open collector phototransistor, external pull up resistors are required  
**Output Code:** 2-Bit quadrature, channel A leads channel B by 90° electrically during clockwise rotation of the shaft  
**Logic Output Characteristics:** Logic High shall be no less than 3.0 Vdc Logic Low shall be no greater than 1.0 Vdc  
**Minimum Sink Current:** 2.0 mA  
**Power Consumption:** 150 mW maximum  
**Mechanical Life:**  
 Non-Detent 3 Million Cycles  
 Low & Medium 1 Million Cycles  
 High 1/2 Million Cycles  
 1 cycle is a rotation through all positions and a full return

**Average Rotational Torque:** H-3.60±1.60 in-oz, M-2.20±1.40 in-oz, L-1.20±0.50 in-oz, N-<0.50 in-oz initially, torque shall be within 50% of initial value throughout life  
**Mounting Torque:** 15 in-oz maximum  
**Shaft Push-Out Force:** 45 lbs minimum  
**Shaft Pull-Out Force:** 45 lbs minimum  
**Terminal Strength:** 15 lbs minimum terminal pull-out force for cable or header termination  
**Solderability:** 95% free of pin holes and voids

#### Pushbutton Electrical and Mechanical Specifications

**Rating:** 10 mA at 5 Vdc  
**Contact Resistance:** <10Ω  
**Life:** 3 million actuations minimum  
**Contact Bounce:** <4 ms Make, <10 ms Break  
**Action Force:** 9-950±250 grams, 5-510±110 grams, 4-400±100 grams, 3-300±90 grams, 2-200±75 grams  
**Shaft Travel:** .020±.010 inch

#### Materials and Finishes

**Bushing:** Zamak 2  
**Shaft:** Aluminum or Zamak 2  
**Retaining Ring:** Stainless steel  
**Pushbutton Actuator:** Zytel 70G33L  
**Detent Spring:** Music wire  
**Detent Ball:** Stainless steel  
**Code Housing:** Polyamide polymer, nylon 6/10 alloy UL94HB  
**Code Rotor:** Delrin 100

**Printed Circuit Boards:** NEMA grade FR-4, double clad with copper, plated with gold over nickel

**Infrared Emitting Diode Chips:** Gallium aluminum arsenide  
**Silicon Phototransistor Chips:** Gold and Aluminum Alloys  
**Resistor:** Metal oxide on ceramic substrate  
**Solder Pins:** Brass, plated with tin  
**Pushbutton Dome:** Stainless steel  
**Backplate:** Stainless steel  
**Cable:** Copper stranded with topcoat in PVC insulation (Cable version only)  
**Connector (.050 Center):** PA4.6 with tin/lead plated phosphor bronze  
**Connector (.100 Center):** Nylon UL94V-2, tin plated copper alloy  
**Label:** TT406 Thermal transfer cast film  
**Solder:** 60/40 Tin lead, no clean – low residue flux  
**Lubricating Grease:** NYE nyogel 774L  
**Hex Nut:** Nickel, plated with brass  
**Lockwasher:** Stainless steel  
**Header:** Hi-Temp glass filled thermoplastic UL94V-0, phosor bronze (pinned versions only)  
**Strain Relief:** Glass filled thermoplastic (.100 center cable versions only)

### OPTIONS

Contact Grayhill for custom terminations, shaft and bushing configurations, rotational torque pushbutton force, and code output. Control knobs are also available.

### ORDERING INFORMATION

**Angle of Throw**

- 45=45° for Code Change and 8 Detent Positions
- 30=30° for Code Change and 12 Detent Positions
- 22=22.5° for Code Change and 16 Detent Positions
- 18=18° for Code Change and 20 Detent Positions
- 15=15° for Code Change and 24 Detent Positions
- 11=11.25° for Code Change and 32 Detent Positions

**Rotational Torque Option**

- N = Non-detent
- L = Low Torque (available with 0, 4, 5, 9 pushbutton only)
- M = Medium Torque (available with 0, 5, 9 pushbutton only)
- H = High Torque (available with 0, 9 pushbutton only)

**Termination**

- C = .050 Center Ribbon Cable with Connector
- S = .050 Center Ribbon Cable with .100 Stripped End
- P = .050 Center Pins with .185 Length
- CH = .100 Center Ribbon Cable with Connector
- SH = .100 Center Ribbon Cable with .100 Stripped End
- PH = .100 Center Pins with .230 Length

**Cable Length**

- 020 thru 250 in 1/2 inch increments
- 3 Digits are eliminated if pinned termination is required.
- Examples:  
060 = 6.0 inch cable  
135 = 13.5 inch cable

**Pushbutton Option**

- 0 = NO PUSHBUTTON
- 9 = 950 Grams
- 5 = 510 Grams
- 4 = 400 Grams
- 3 = 300 Grams
- 2 = 200 Grams

**62SXX-XX-XXXX**