

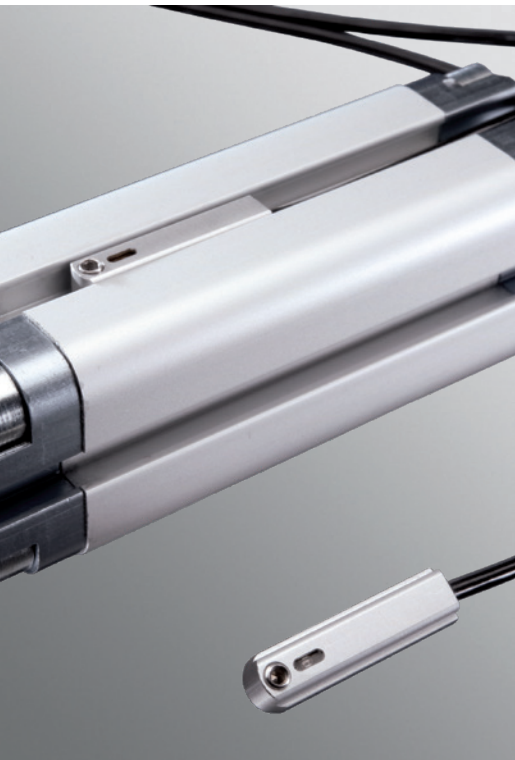

**Complete Range
Sensor Systems**



BERNSTEIN AG

A Success Story



Safety for man and machine

BERNSTEIN AG ranks among the world's leading providers of industrial safety technology. With our comprehensive range of switches, sensors, enclosures, suspension systems and other components for industrial applications, we offer our customers effective and versatile solutions.

In-depth market knowledge, the close proximity to end users as well as years of experience in mechanical engineering and electronics are reflected down to the last detail in our products.

By conforming to international safety guidelines, our products perfectly integrate in individual system solutions. Our focus is complete commitment to safety for man, machine and industrial processes.

Our expertise for your safety

With sound application expertise we support our customers from all branches of industry in the planning and implementation of systems designed to meet stringent safety requirements. In addition to classic plant and machine construction, we look after customers in the lift construction, automotive, agriculture, conveyor construction, automation engineering, wood-working, renewable energy, AS-Interface and EX.

Our knowledge is your success



GERMANY
Porta Westfalica
BERNSTEIN
BUSINESS CENTER



GERMANY
Hille-Hartum



EUROPE
Budapest (Hungary)
BERNSTEIN Kft.



ASIA
Taicang (China)
BERNSTEIN Safe Solutions

Our philosophy

Customer Satisfaction is our number one priority. For us, Quality is more than making a good product, it's about designing them to perfectly match ALL of your needs.

Customized Solutions are fully integrated into our business and form part of our everyday working life. Employees are treated as our greatest asset as they are responsible for the quality and success of our products. All BERNSTEIN TEAM members are trained and educated to the highest possible standard so they can deliver "Best in Class" Service and Support. The BERNSTEIN TEAM will support you both personally and professionally, working together we will provide you with the best Safe Solution – for any size of project.

Future-proof solutions

Our objective is to actively influence technical innovation and modern application solutions. BERNSTEIN has therefore always been at the centre of defining trends in technology. With an unwavering commitment to the future we will continue providing the best possible answers in terms of technology, ecology and economic efficiency.

That is our definition of progress!

BERNSTEIN AG

The Product Lines

Switch Systems



Switch systems – Economy meets safety

BERNSTEIN electromechanical switches offer a convincing price/performance ratio and impress with their extreme reliability for many different operating voltages. The range extends from limit switches, encapsulated in insulating material or metal, through foot switches to safety switching devices. The AS-i compatible products save time and material in installation and provide cost advantages in operation. The comprehensive range of designs and sizes, the possible switching functions and the choice of actuators make virtually any application reality.

Sensor Systems



Sensor systems – Compact intelligence

The extremely fast and exceptionally precise BERNSTEIN sensors operate without interference and wear in all applications. The tried-and-tested reliability and the compact dimensions are greatly appreciated in all branches of industry. Matching the specific application, in addition to ultrasonic sensors and level switches, customers can choose from a wide range of inductive, capacitive, magnetic or optical sensors. Alongside the comprehensive standard range of sensors, we also offer comprehensive development and design for individual solutions.

Enclosure Systems



Enclosure systems – Function and design

With its long tradition in manufacturing enclosures, BERNSTEIN combines superior enclosure technology, designed for encapsulating a diverse range of applications, with ultramodern and variable suspension systems. An extensive range of aluminium and plastic terminal boxes as well as the wiring and circuitry in standard and control enclosures conforming to specific customer requirements round off the product portfolio. Our enclosures conform to standards used in medical technology, industry as well as food and EX applications.

Product Line Sensor Systems



Sensor systems – Compact intelligence

BERNSTEIN is an established manufacturer of high quality electromechanical and electronic low voltage switching devices and sensors. Our products are used in the most diverse range of applications, ranging from lift construction through wood-working and packaging machines through to machine tools.

Contactless sensors are characterised by absolute reliability, suitability for a wide range of applications and optimum cost-benefit ratio. Their main purpose is to convert mechanical movement into electrical signals that are processed in control systems.

In modern day applications, however, sensors directly connected to bus systems are being used to an ever greater extent to monitor mechanical movement and convert it into digital information.

Selecting the right sensor for the job depends on the prevailing ambient and operating conditions as well as corresponding technical requirements. In addition to the detection method (inductive, capacitive, optical, ultrasonic or magnetic) it is also necessary to select the corresponding output function (PNP, NPN, AC, normally-closed or normally-open contact). Sensing distances as well as the direction and type of approach are also important selection criteria. In view of the large number of possible combinations, the scope of application is virtually unlimited.

Maximum functions – minimum space

The range of applications in which limit switches are used has changed in line with increasing automation. Sensors are no longer used purely for the purpose of detecting position but rather they must be able to output analogue values for the purpose of calculating the distance with the necessary signal processing already taking place in the sensor itself. A sensor can also be used to sample two switching points in order to reduce the number of components in machines and systems.

This functionality is achieved by the use of state-of-the-art microcontrollers and advanced sensor technologies. Modern sensors from BERNSTEIN therefore open up new applications, extend the range of functions and as a result significantly increase efficiency.

Complementing our product range we offer attractive customer services:

- Assistance in assessing risk and configuring safety functions
- Preassembly of products with standard power supply lines or customised cables
- Supply of M8 or M12 connection technology
- Development of sensors to customer specifications
- Development and manufacture of customer-specific system solutions



Inductive Sensors

Type	Page
General	12
 <ul style="list-style-type: none"> • ø 3 mm • ø 4 mm • ø 6,5 mm • M4 • M5 	14
 <ul style="list-style-type: none"> • M8 	16
 <ul style="list-style-type: none"> • M12 	18
 <ul style="list-style-type: none"> • M18 	22
 <ul style="list-style-type: none"> • M30 	28
 <ul style="list-style-type: none"> • ø 34 mm 	32
 <ul style="list-style-type: none"> • 5 x 5 x 25 mm • 8 x 8 x 40 mm • 8 x 8 x 56 mm • 12 x 12 x 55 mm 	32
 <ul style="list-style-type: none"> • 27 x 10 x 5 mm • 28 x 16 x 11 mm • 40 x 26 x 12 mm • 50 x 25 x 10 mm • 60 x 36 x 10 mm 	33
 <ul style="list-style-type: none"> • 68 x 30 x 15 mm • 40 x 40 mm 	36

Capacitive Sensors

Type	Page
General	38
 <ul style="list-style-type: none"> • M12 • M18 	42
 <ul style="list-style-type: none"> • M30 • M32 	44
 <ul style="list-style-type: none"> • ø 20 mm • ø 34 mm 	46
 <ul style="list-style-type: none"> • 50 x 25 x 10 mm • 68 x 30 x 15 mm 	47

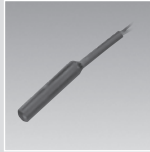

Magnetic Switches

Type	Page
General	48
 <ul style="list-style-type: none"> Electromechanical magnetic switches <ul style="list-style-type: none"> • Plastic • Metal 	52
General	60
 <ul style="list-style-type: none"> Electronic magnetic sensors <ul style="list-style-type: none"> • Plastic • Metal 	62

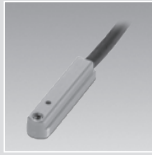
Slot Sensors

Type	Page
General	71
 <ul style="list-style-type: none"> • E22 • E30 • Analogue • Teachable • Electronic • Reed contact 	72

Contactless safety technology

Type	Page
 <ul style="list-style-type: none"> Non-contact Safety Sensor SRF 	75
 <ul style="list-style-type: none"> Magnetic Monitoring Systems 	84

Accessories



Magnets 88



Cable couplers 94

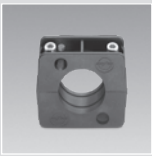

• Mounting brackets 96



Sensor tester 98

Annex

Type code 100

Wiring diagrams 109

Inductive Sensors

Functional principle

In general, inductive proximity switches consist of four basic elements: a coil, an oscillator, a threshold switch and an output stage with short-circuit protection. The oscillator generates a high frequency, electromagnetic alternating field which is emitted from the active face of the coil. Eddy currents are induced in a metal object that enters this field. These eddy currents draw energy from both the electromagnetic field and from the oscillator which is consequently attenuated. The more energy taken the closer the metal object moves towards the active face. The threshold switch switches on the output stage at a defined attenuation value. In proximity switches with a DC voltage supply, this switch is designed as an NPN transistor which switches the connected load to the negative pole or as a PNP transistor which switches the load to the positive pole. The output stage is a thyristor or a triac in AC voltage switches.

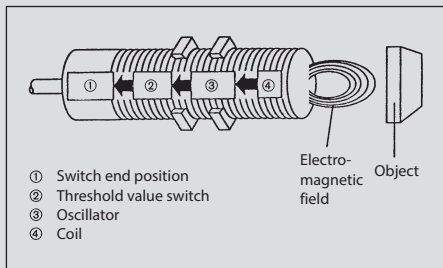

Sensing distance

The sensing distance (gap) is determined by the coil diameter, i.e. larger sensors are required for larger sensing distances. The sensing distance is also dependent on the size of the metal object to be detected as well as the material it is made from.

Target

The sensing distance is measured with a 1 mm thick square measuring plate made of steel (ST 37) referred to as a target. The edge length is equal to the diameter of the active face or equal to three times the sensing distance depending on which value is greater.

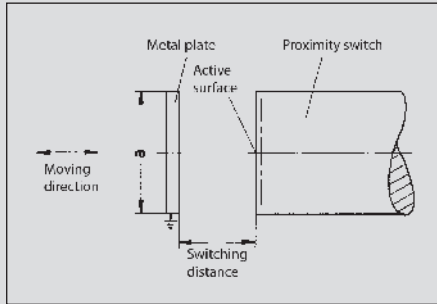

Nominal sensing distance: (Sn)

The nominal sensing distance is a device-specific characteristic value that is dependent on the coil diameter.

Real sensing distance: (Sr)

The real sensing distance is measured at nominal voltage and nominal temperature. It must be between 90 % – 110 % of the nominal sensing distance.

Useable sensing distance: (Su)

The useable sensing distance is measured within the permissible temperature and voltage ranges and is 90 % – 110 % of the real sensing distance.

Operational sensing distance: (Sa) (Assured operation distance)

The operational sensing distance takes into account the influence of the supply voltage, temperature and control systems. Reliable switching under all permissible operating conditions is assured within 0 % – 81 % of the nominal sensing distance. $S_a \sim 0.81 S_n$.

Hysteresis: (H)

Hysteresis refers to the difference between the switch-on point as an object approaches and the switch-off point as the object moves away. This hysteresis is specified as a percentage of the nominal sensing distance and is typically 10 %. It is required to prevent the output chattering in response to slowly approaching objects, temperature drift, electrical interference or vibration.

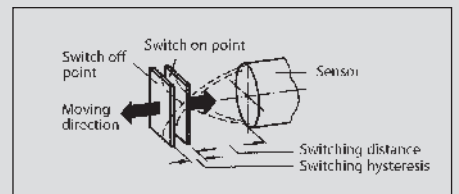
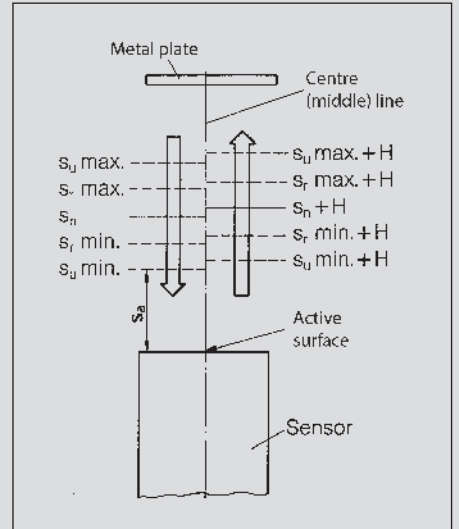

Repeatability

Repeatability is the ability of a sensor to repeatedly detect an object at the same distance away from the sensing surface. The typical deviation is < 5 %.

Reduction factors

The definition of the sensing distance is based on the measurement performed with a standardised square target made of steel. If other materials with the same dimensions are used, the sensing distance will be reduced as shown in the following graphic.

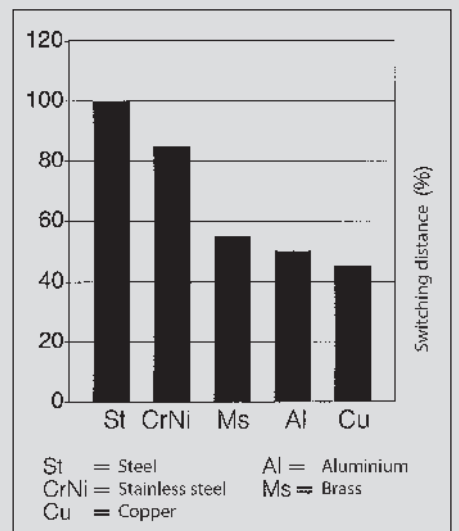

Switching frequency

The switching frequency is measured with a redating, non-conductive plate, on which the standard targets are mounted as illustrated (size of targets as previously defined).

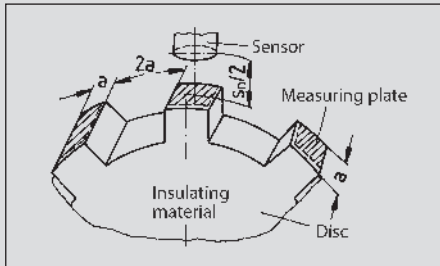

The distance between the targets and sensor is equal to half the nominal sensing distance. The maximum switching frequency is reached when the switch-on or switch-off signal time drops below 50 μ s.

Temperature range

For most sensors, the permissible ambient temperature range is between $-25\text{ }^{\circ}\text{C}$ and $+70\text{ }^{\circ}\text{C}$ ($-13\text{ }^{\circ}\text{F}$ to $+158\text{ }^{\circ}\text{F}$). Sensors with an extended temperature range of $-40\text{ }^{\circ}\text{C}$ to $+100\text{ }^{\circ}\text{C}$ are also available.

Assembly

Inductive sensors contain a coil on a ferromagnetic core that bundles the electromagnetic alternating field. The core is installed into the enclosure in such a way that the field emerges from the switch at the active face. A part of the magnetic field, however, also emerges from the side of the core. The sensor in a flush mount arrangement would already be influenced by the metal on the sides. For this reason, a metal band is fitted about the core in plastic enclosures, thus restricting the lateral magnetic field in a flush mount configuration. Due to the pre-attenuation attributed to the metal ring or a metal enclosure, flush mount versions have a shorter sensing distance than non-flush mount sensors and can be mounted closer to each other.

Flush mount

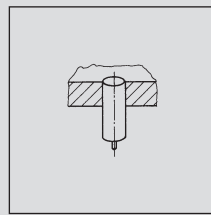

The active face can be flush with a metal surface.

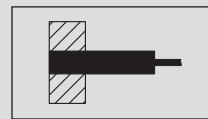

Catalogue symbol for flush mount

Non-flush mount

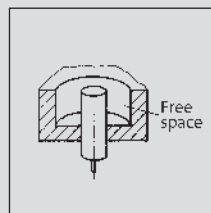

Sensors for non-flush mount require a clearance equal to three times the sensor enclosure diameter and a min. depth of $2 \times S_n$.

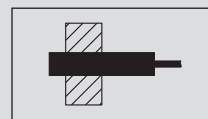

Catalogue symbol for non-flush mount

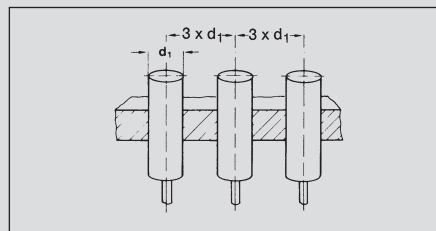

Minimum spacing between non-flush mount sensors

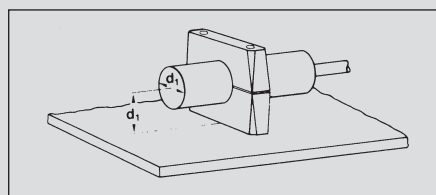

Installation with a mounting bracket parallel to a steel wall

NAMUR sensors

(Standardization association for measurement and control in chemical industries)

Protection class

Corresponding to their ID code, the enclosures are dustproof and waterproof in accordance with IP65 or IP67 (EN 60529).

Short-circuit protection

Standard sensors are protected against short-circuit (cyclic) and polarity reversal.

Tightening torque requirements

BERNSTEIN supplies corresponding mounting nuts with its sensors. Refer to the respective datasheets for the required tightening torque.

Tightening torque examples for sensors in brass enclosure:

M4	0.8 Nm
M5	1.5 Nm
M8	8 Nm
M12	10 Nm
M18	25 Nm
M30	70 Nm

Materials

The sensors are protected by a glass fibre reinforced thermoplastic, brass or stainless steel enclosure. The connection cable has a PVC or PU sheathing.

Connection systems

The following connection systems are available for standard sensors:

- Cable variants (2 m) with PVC or PUR sheathing
- Connector variants with M8, M12 connector or connector conforming to DIN 43650
- Quick-connect system with Ultralock connectors

Standards and approvals

All sensors are CE-certified. The following European standards apply in accordance with CENELEC:

- EN 60947-5-2 Proximity switches
- EN 60947-5-6 NAMUR sensors

Inductive Sensors (Type Ø 3 mm, Ø 4 mm, Ø 6.5 mm, M4, M5)

Type	Ø 3 mm	Ø 4 mm	Ø 6.5 mm	
Type of installation	Flush	Flush	Flush	Flush
Nominal sensing distance	0.6 mm	0.8 mm	1.5 mm	1.5 mm
Type of connection	Cable 2 m	Cable 2 m	Cable 2 m	Connector M8
Special feature				

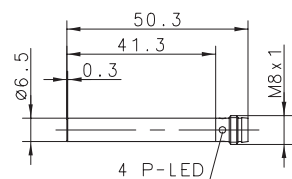
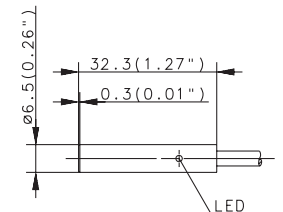
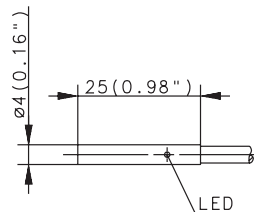
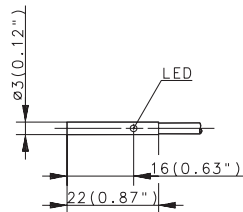

PNP	DC	NO contact	6502999019 KIB-D03PS/0,6-KL2PU	6502999004 KIB-D04PS/0,8-KL2PU	6502999010 KIB-D06PS/1,5-KL2	6502999012 KIB-D06PS/1,5-KLSM8
		Type				
NPN	DC	NC contact	6502799007 KIB-D03PÖ/0,6-KL2PU	6502799002 KIB-D04PÖ/0,8-KL2PU	6502799011 KIB-D06PÖ/1,5-KL2	
		Type				
PNP/NPN	DC	Antivalent NO/NC				
		Type				
NAMUR	DC	NO contact				
		Type				
Analogue	DC	NC contact				
		Type				
2-wire	DC	NO contact				
		NC contact				
	AC	NO contact				
		NC contact				
		Changeover contact				

Technical data

Rated operating voltage	U_B	10–30 VDC	10–30 VDC	10–36 VDC	10–36 VDC
Rated operating current	I_B	≤ 100 mA	≤ 200 mA	≤ 200 mA	≤ 200 mA
Switching frequency (max)	F	3000 Hz	3000 Hz	1000 Hz	1000 Hz
Short circuit-protection		Cyclic	Cyclic	Cyclic	Cyclic
Function/operating voltage indicator		LED/-	LED/-	LED/-	LED/-
Sensing distance, adjustable					

Mechanical data

Ambient temperature (min/max)		-25°C/+70°C	-25°C/+70°C	-25°C/+70°C	-25°C/+70°C
Protection class in accordance with IEC 529, EN 60529		IP67	IP67	IP67	IP67
Enclosure material		Stainless steel 1.4305	Stainless steel 1.4401	Stainless steel 1.4401	Stainless steel 1.4401
Connection		3 x 0.055 mm ²	3 x 0.14 mm ²	3 x 0.14 mm ²	M8 x 1

Please refer to Accessories for cable couplers, mounting brackets and sensor tester.



Ø 6.5 mm		M4	M5	M5	
Flush	Flush	Flush	Flush	Flush	Flush
1.5 mm	1.5 mm	0.6 mm	1 mm	1 mm	1 mm
Cable 2 m	Cable 5 m	Cable 2 m	Cable 2 m	Connector M8	Cable 2 m
					NAMUR

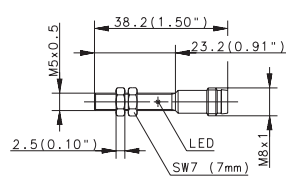
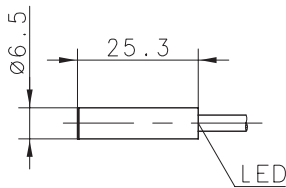
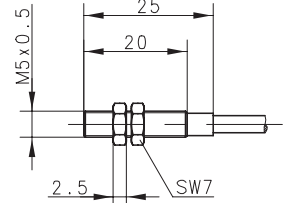
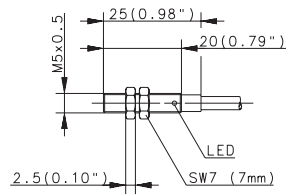
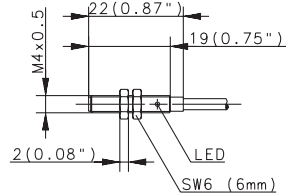
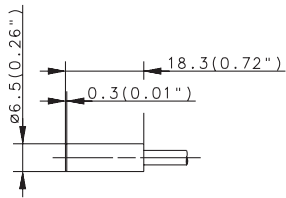

6502999034 KIB-D06PS/1,5-K2VPU	6602999460 KIB-D06PS/1,5-KL5V	6502999020 KIB-M04PS/0,6-KL2PU		6502999003 KIB-M05PS/001-KL2PU 6502799001 KIB-M05PÖ/001-KL2PU	6502999018 KIB-M05PS/001-KLSM8 6502799019 KIB-M05PÖ/001-KLSM8		
				6502399003 KIB-M05NS/001-KL2PU			
							6501699008 KIB-M05EA/001-2

10–36 VDC	10–36 VDC	10–30 VDC	10–30 VDC	10–30 VDC	5–25 VDC
≤ 200 mA	≤ 200 mA	≤ 100 mA	≤ 200 mA	≤ 200 mA	–
1000 Hz	1000 Hz	3000 Hz	3000 Hz	3000 Hz	≈ 3 kHz
Cyclic	Cyclic	Cyclic	Cyclic	Cyclic	–
–/–	LED/–	LED/–	LED/–	LED/–	–/–

–25°C/+70°C	–25°C/+70°C	–25°C/+70°C	–25°C/+70°C	–25°C/+70°C	–25°C/+70°C
IP67	IP67	IP67	IP67	IP67	IP67
Stainless steel 1.4401	Stainless steel 1.4401	Stainless steel 1.4305	CuZn39Pb3	CuZn39Pb3	CuZn39Pb3
3 x 0.14 mm ²	3 x 0.14 mm ²	3 x 0.055 mm ²	3 x 0.14 mm ²	M8 x 1	2 x 0.14 mm ²

You will find detailed data sheets to the products under www.bernstein.eu



Inductive Sensors (Type M8)

Type	M8		M8		M8
Type of installation	Flush	Flush	Flush	Flush	Flush
Nominal sensing distance	1.5 mm	1.5 mm	1.5 mm	1.5 mm	1.5 mm
Type of connection	Cable 2 m	Cable 6 m	Connector M8	Connector M8	Connector M12
Special feature					

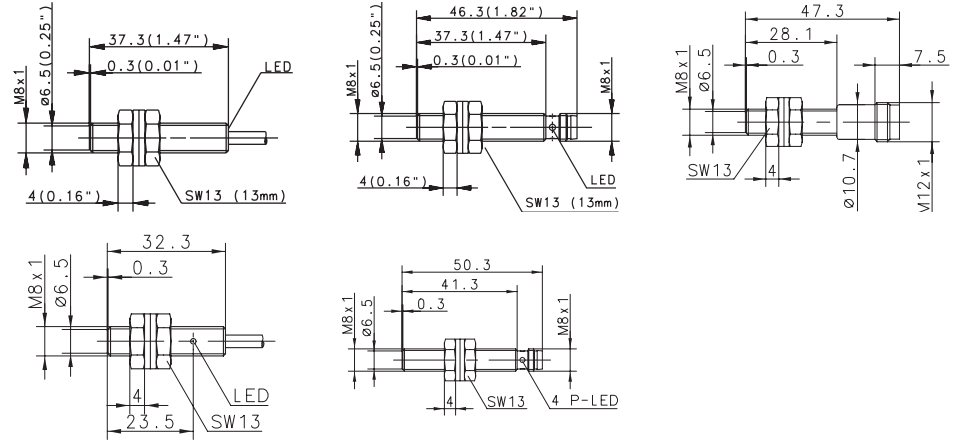

PNP	DC	NO contact Type NC contact Type Antivalent NO/NC	6932901001 KIB-M08PS/1,5-KL2	6502901004 KIB-M08PS/1,5-KL6 6502701001 KIB-M08PÖ/1,5-KL2	6932942001 KIB-M08PS/1,5-KLSM8	6502742001 KIB-M08PÖ/1,5-KLSM8	6502942007 KIB-M08PS/0,1-KS12
NPN	DC	NO contact Type NC contact Antivalent NO/NC	6932301001 KIB-M08NS/1,5-KL2		6932342001 KIB-M08NS/1,5-KLSM8		
PNP/NPN	DC	NO/NC prog. push-pull operation					
NAMUR	DC	Type					
Analogue	DC						
2-wire	DC	NO contact NC contact					
	AC	NO contact NC contact Changeover contact					

Technical data

Rated operating voltage	U_B	10–36 VDC	10–36 VDC	10–36 VDC	10–36 VDC	10–36 VDC
Rated operating current	I_B	≤ 200 mA	≤ 200 mA	≤ 200 mA	≤ 200 mA	≤ 200 mA
Switching frequency (max)	F	1000 Hz	1000 Hz	1000 Hz	1000 Hz	1000 Hz
Short circuit-protection		Cyclic	Cyclic	Cyclic	Cyclic	Cyclic
Function/operating voltage indicator		LED/-	LED/-	LED/-	LED/-	-/-
Sensing distance, adjustable						

Mechanical data

Ambient temperature (min/max)		-25°C/+70°C	-25°C/+70°C	-25°C/+70°C	-25°C/+70°C	-25°C/+70°C
Protection class in accordance with IEC 529, EN 60529		IP67	IP67	IP67	IP67	IP67
Enclosure material		Stainless steel 1.4305	Stainless steel 1.4305	Stainless steel 1.4305	Stainless steel 1.4305	Stainless steel 1.4305
Connection		3 x 0.14 mm ²	3 x 0.14 mm ²	M8 x 1	M8 x 1	M12 x 1

Please refer to Accessories for cable couplers, mounting brackets and sensor tester.



M8	M8		M8
Flush 1.5 mm Cable 2 m NAMUR	Non-flush 2 mm Cable 2 m	Non-flush 2 mm Connector M8	Non-flush 2 mm Connector M12

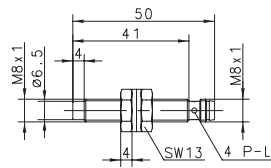
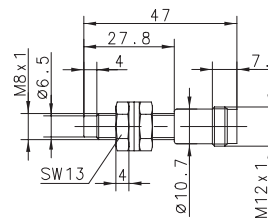
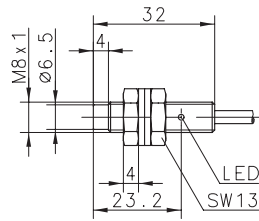
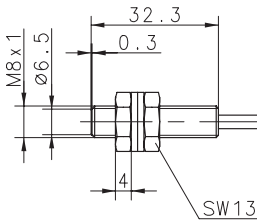

	6502916003 KIN-M08PS/002-KL2	6502942006 KIN-M08PS/002-KLSM8	6502942008 KIN-M08PS/002-KS12	
6501601003 KIB-M08EA/1,5-2				

5-25 VDC	10-36 VDC	10-36 VDC	10-36 VDC
-	≤ 200 mA	≤ 200 mA	≤ 200 mA
≈ 1 kHz	750 Hz	750 Hz	750 Hz
-	Cyclic	Cyclic	Cyclic
-/-	LED/-	LED/-	-/-

-25°C/+70°C	-25°C/+70°C	-25°C/+70°C	-25°C/+70°C
IP67	IP67	IP67	IP67
Stainless steel 1.4305	Stainless steel 1.4305	Stainless steel 1.4305	Stainless steel 1.4305
2 x 0.25 mm ²	3 x 0.14 mm ²	M8 x 1	M12 x 1

You will find detailed data sheets to the products under www.bernstein.eu



Inductive Sensors (Type M8, M12)

Type	M8	M12	M12	M12
Type of installation	Non-flush	Flush	Flush	Flush
Nominal sensing distance	2 mm	2 mm	2 mm	2 mm
Type of connection	Cable 2 m	Cable 2 m	Cable 2 m	Connector M12
Special feature	NAMUR			

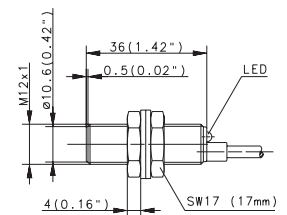
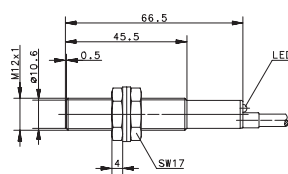
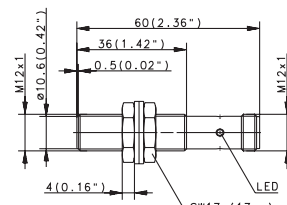
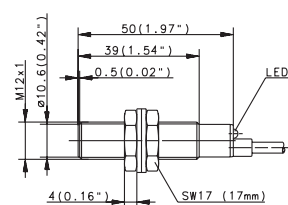
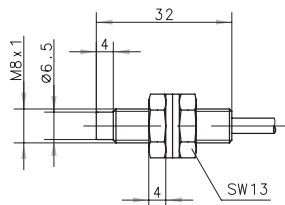

PNP	DC	NO contact Type NC contact Type Antivalent NO/NC		6932903001 KIB-M12PS/002-KL2	6932943001 KIB-M12PS/002-KLS12 6602743112 KIB-M12PÖ/002-KLS12	6502903016 KIB-M12PS/002-KL2V 6502703005 KIB-M12PÖ/002-KL2V
NPN	DC	NO contact Type NC contact Type Antivalent NO/NC		6932303001 KIB-M12NS/002-KL2	6932343001 KIB-M12NS/002-KLS12	6502103003 KIB-M12NÖ/002-KL2V
PNP/NPN	DC	NO/NC prog. push-pull operation				
NAMUR	DC	Type		6501601005 KIN-M08EA/002-2		
Analogue	DC					
2-wire	DC	NO contact NC contact				
	AC	NO contact Type NC contact Changeover contact		6503503001 KIB-M12AS/002-L2		

Technical data

Rated operating voltage	U_B	5–25 VDC	10–36 VDC	76–250 V AC	10–36 VDC	10–36 VDC
Rated operating current	I_B	–	≤ 200 mA	≤ 200 mA	≤ 200 mA	≤ 200 mA
Switching frequency (max)	F	≈ 1 kHz	800 Hz	≈ 10 Hz	800 Hz	800 Hz
Short circuit-protection		–	Cyclic	–	Cyclic	Cyclic
Function/operating voltage indicator		–/–	LED/–	LED/–	LED/–	LED/–
Sensing distance, adjustable						

Mechanical data

Ambient temperature (min/max)		–25°C/+70°C	–25°C/+70°C	–25°C/+70°C	–25°C/+70°C	–25°C/+70°C
Protection class in accordance with IEC 529, EN 60529		IP67	IP67	IP67	IP67	IP67
Enclosure material		Stainless steel 1.4305	CuZn39Pb3	CuZn39Pb3	CuZn39Pb3	CuZn39Pb3
Connection		2 x 0.25 mm ²	3 x 0.14 mm ²	2 x 0.14 mm ²	M12 x 1	3 x 0.14 mm ²

Please refer to Accessories for cable couplers, mounting brackets and sensor tester.



M12	M12	M12	
Flush	Flush	Flush	Flush
2 mm	2 mm	2 mm	2 mm
Connector M8	Connector M12	Cable 2 m	Cable 2 m
		4000 Hz	NAMUR

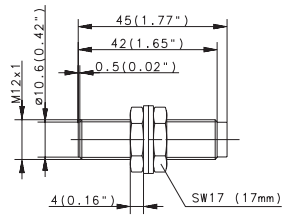
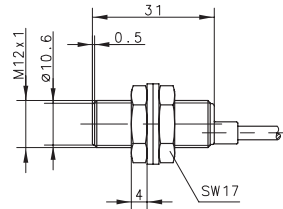
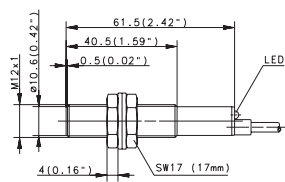
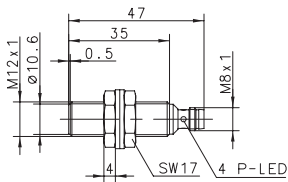

6502943008 KIB-M12PS/002-KLSM8V	6502943006 KIB-M12PS/002-KS12V 6502743005 KIB-M12PÖ/002-KS12V	6502903012 KIB-M12PS/002-KL2F				
				6501624760 KIB-M12EA/002-2		

10–30 VDC	10–36 VDC	10–60 VDC	5–25 VDC
≤ 200 mA	≤ 200 mA	≤ 200 mA	–
800 Hz	800 Hz	4000 Hz	≤ 800 Hz
Cyclic	Cyclic	Cyclic	–
LED/–	–/–	LED/–	–/–

–25°C/+70°C	–25°C/+70°C	–25°C/+70°C	–25°C/+70°C
IP67	IP67	IP67	IP67
CuZn39Pb3	CuZn39Pb3	CuZn39Pb3	CuZn39Pb3
M8 x 1	M12 x 1	3 x 0.14 mm ²	2 x 0.25 mm ²

You will find detailed data sheets to the products under www.bernstein.eu



Inductive Sensors (Type M12)

Type	M12		M12		M12	
Type of installation	Flush	Flush	Flush	Non-flush	Non-flush	
Nominal sensing distance	4 mm	4 mm	4 mm	4 mm	4 mm	
Type of connection	Cable 2 m	Connector M12	Cable 2 m	Cable 2 m	Cable 2 m	
Special feature	Sensing dist.	Sensing dist.	Sensing dist.			

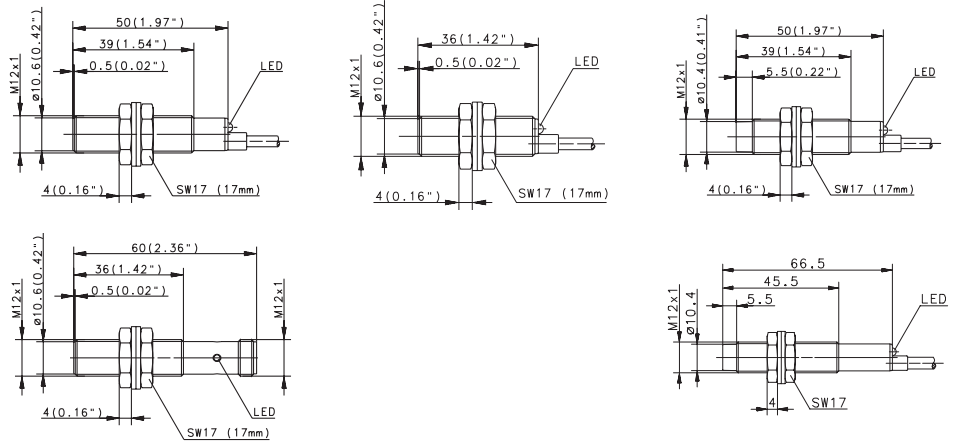

PNP	DC	NO contact Type NC contact Type Antivalent NO/NC	6502903025 KIB-M12PS/004-KL2E	6502943015 KIB-M12PS/004-KLS12E	6502903023 KIB-M12PS/004-KL2VE	6932904001 KIN-M12PS/004-KL2 6932704001 KIN-M12PÖ/004-KL2
NPN	DC	NO contact Type NC contact Type Antivalent NO/NC				6932304001 KIN-M12NS/004-KL2 6932104001 KIN-M12NÖ/004-KL2
PNP/NPN	DC	NO/NC prog. push-pull operation				
NAMUR	DC					
Analogue	DC					
2-wire	DC	NO contact NC contact				6503504001 KIN-M12AS/004-L2 6503404001 KIN-M12ÄÖ/004-L2
	AC	NO contact Type NC contact Type Changeover contact				

Technical data

Rated operating voltage	U_B	10–30 VDC	10–36 VDC	10–36 VDC	10–36 VDC	76–250 V AC
Rated operating current	I_B	≤ 200 mA	≤ 200 mA	≤ 200 mA	≤ 200 mA	≤ 200 mA
Switching frequency (max)	F	800 Hz	800 Hz	800 Hz	400 Hz	≈ 10 Hz
Short circuit-protection		Cyclic	Cyclic	Cyclic	Cyclic	–
Function/operating voltage indicator		LED/–	LED/–	LED/–	LED/–	LED/–
Sensing distance, adjustable						

Mechanical data

Ambient temperature (min/max)		–25°C/+70°C	–25°C/+70°C	–25°C/+70°C	–25°C/+70°C	–25°C/+70°C
Protection class in accordance with IEC 529, EN 60529		IP67	IP67	IP67	IP67	IP67
Enclosure material		CuZn39Pb3	CuZn39Pb3	CuZn39Pb3	CuZn39Pb3	CuZn39Pb3
Connection		3 x 0.14 mm ²	M12 x 1	3 x 0.14 mm ²	3 x 0.14 mm ²	2 x 0.14 mm ²

Please refer to Accessories for cable couplers, mounting brackets and sensor tester.



M12		M12			
Non-flush 4 mm Connector M12	Non-flush 4 mm Cable 2 m	Non-flush 4 mm Connector M12	Non-flush 4 mm Cable 2 m Plastic		

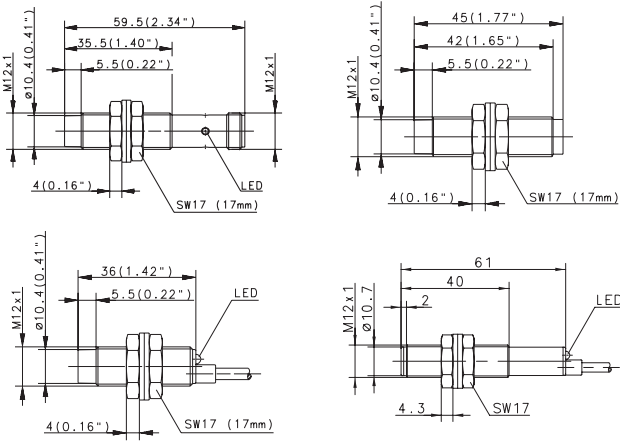

6932944001 KIN-M12PS/004-KLS12	6502904014 KIN-M12PS/004-KL2V	6502944006 KIN-M12PS/004-KS12V	6502919001 KIN-T12PS/004-KL2				
6502744003 KIN-M12PÖ/004-KLS12							
6932344001 KIN-M12NS/004-KLS12							

10–36 VDC	10–36 VDC	10–36 VDC	10–30 VDC		
≤ 200 mA	≤ 200 mA	≤ 200 mA	≤ 200 mA		
400 Hz	400 Hz	400 Hz	400 Hz		
Cyclic	Cyclic	Cyclic	Cyclic		
LED/–	LED/–	–/–	LED/–		

–25°C/+70°C	–25°C/+70°C	–25°C/+70°C	–25°C/+70°C		
IP67	IP67	IP67	IP67		
CuZn39Pb3	CuZn39Pb3	CuZn39Pb3	PA, red		
M12 x 1	3 x 0.14 mm ²	M12 x 1	3 x 0.14 mm ²		

You will find detailed data sheets to the products under www.bernstein.eu



Inductive Sensors (Type M12, M18)

Type	M12	M12	M12	M18	M18
Type of installation	Non-flush	Non-flush	Non-flush	Flush	Flush
Nominal sensing distance	4 mm	8 mm	8 mm	5 mm	5 mm
Type of connection	Cable 2 m	Cable 2 m	Connector M12	Cable 2 m	Cable 2 m
Special feature	NAMUR	Sensing dist.	Sensing dist.		

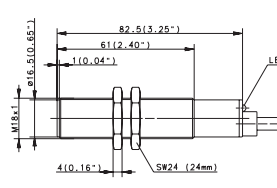
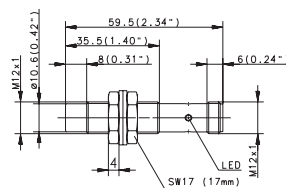
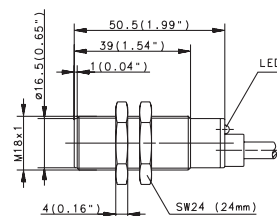
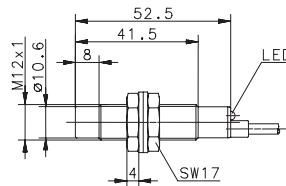
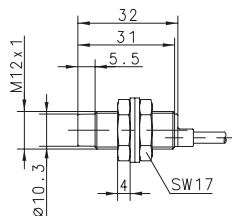

PNP	DC	NO contact Type NC contact Type Antivalent NO/NC Type		6502904021 KIN-M12PS/008-KL2E	6502944013 KIN-M12PS/008-KLS12E	6932905001 KIB-M18PS/005-KL2 6932705001 KIB-M18PÖ/005-KL2
NPN	DC	NO contact Type NC contact Type Antivalent NO/NC Type			6602344458 KIN-M12NS/008-KLS12E	6932105001 KIB-M18NÖ/005-KL2
PNP/NPN	DC	NO/NC prog. push-pull operation				
NAMUR	DC	Type	6501625761 KIN-M12EA/004-2			
Analogue	DC					
2-wire	DC	NO contact NC contact				
	AC	NO contact Type NC contact Type Changeover contact				6503505004 KIB-M18AS/005-L2 6503405001 KIB-M18AÖ/005-L2

Technical data

Rated operating voltage	U_B	5–25 VDC	10–36 VDC	10–36 VDC	10–36 VDC	20–250 V AC
Rated operating current	I_B	–	≤ 200 mA	≤ 200 mA	≤ 200 mA	≤ 400 mA
Switching frequency (max)	F	≤ 400 Hz	400 Hz	400 Hz	500 Hz	≈ 10 Hz
Short circuit-protection		–	Cyclic	Cyclic	Cyclic	–
Function/operating voltage indicator		–/–	LED/–	LED/–	LED/–	LED/–
Sensing distance, adjustable						

Mechanical data

Ambient temperature (min/max)		–25°C/+70°C	–25°C/+70°C	–25°C/+70°C	–25°C/+70°C	–25°C/+70°C
Protection class in accordance with IEC 529, EN 60529		IP67	IP67	IP67	IP67	IP67
Enclosure material		CuZn39Pb3	CuZn39Pb3	CuZn39Pb3	CuZn39Pb3	CuZn39Pb3
Connection		2 x 0.25 mm ²	3 x 0.14 mm ²	M12 x 1	3 x 0.5 mm ²	2 x 0.5 mm ²

Please refer to Accessories for cable couplers, mounting brackets and sensor tester.



M18		M18		M18		M18	
Flush 5 mm Connector M12	Flush 5 mm Cable 6 m	Flush 5 mm Connector M12	Flush 5 mm DIN Connector	Flush 5 mm DIN Connector	Flush 5 mm DIN Connector	Flush 5 mm Cable 2 m Plastic	Flush 5 mm Cable 2 m Plastic

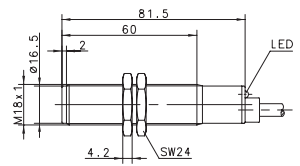
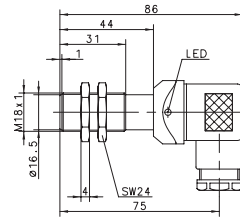
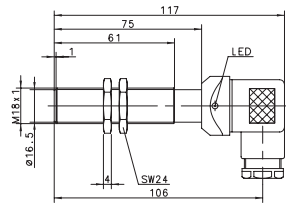
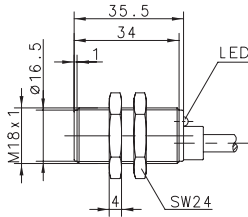
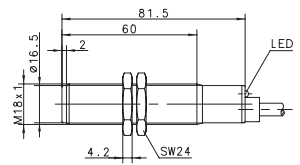
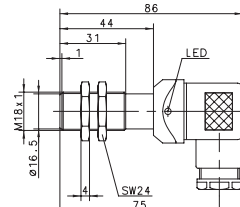
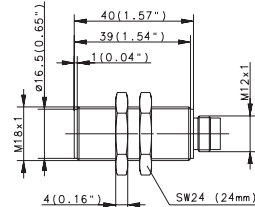
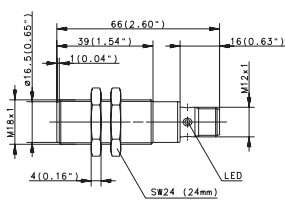

6932905004 KIB-M18PS/005-KLS12	6502905013 KIB-M18PS/005-KL6V	6502905012 KIB-M18PS/005-KS12V 6502705007 KIB-M18PÖ/005-KS12V	6602905662 KIB-M18PS/005-KLSD 6502705001 KIB-M18PÖ/005-KLSD	6502940001 KIB-M18PS/005-KLSDV 6502840002 KIB-M18PU/005-KSDV	6502920990 KIB-T18PS/005-KL2		
6932305004 KIB-M18NS/005-KLS12							6503520697 KIB-T18AS/005-L2

10–36 VDC ≤ 200 mA 500 Hz Cyclic LED/–	10–60 VDC ≤ 200 mA 500 Hz Cyclic LED/–	10–60 VDC ≤ 200 mA 500 Hz Cyclic –/–	10–60 VDC ≤ 200 mA 500 Hz – LED/–	10–60 VDC ≤ 200 mA 500 Hz Cyclic LED/–	10–60 VDC ≤ 200 mA 500 Hz Cyclic –/–	10–60 VDC ≤ 200 mA 500 Hz Cyclic LED/–	24–250 V AC ≤ 200 mA ≈ 10 Hz – LED/–
--	--	--	---	--	--	--	--

–25°C/+70°C IP67 CuZn39Pb3 M12 x 1	–25°C/+70°C IP67 CuZn39Pb3 3 x 0.5 mm ²	–25°C/+70°C IP67 CuZn39Pb3 M12 x 1	–25°C/+70°C IP65 CuZn39Pb3 DIN 43650	–25°C/+70°C IP65 CuZn39Pb3 DIN 43650	–25°C/+70°C IP65 CuZn39Pb3 DIN 43650	–25°C/+70°C IP67 PA, red 3 x 0.5 mm ²	–25°C/+70°C IP67 PA, red 2 x 0.5 mm ²
---	---	---	---	---	---	---	---

You will find detailed data sheets to the products under www.bernstein.eu



Inductive Sensors (Type M18)

Type	M18		M18		M18	
Type of installation	Flush	Flush	Flush	Flush	Flush	Flush
Nominal sensing distance	5 mm	5 mm	5 mm	8 mm	8 mm	8 mm
Type of connection	Connector M12	Cable 2 m	Cable 2 m	Cable 2 m	Connector M12	Connector M12
Special feature	Temperature	Temperature	NAMUR	Sensing dist.	Sensing dist.	Sensing dist.

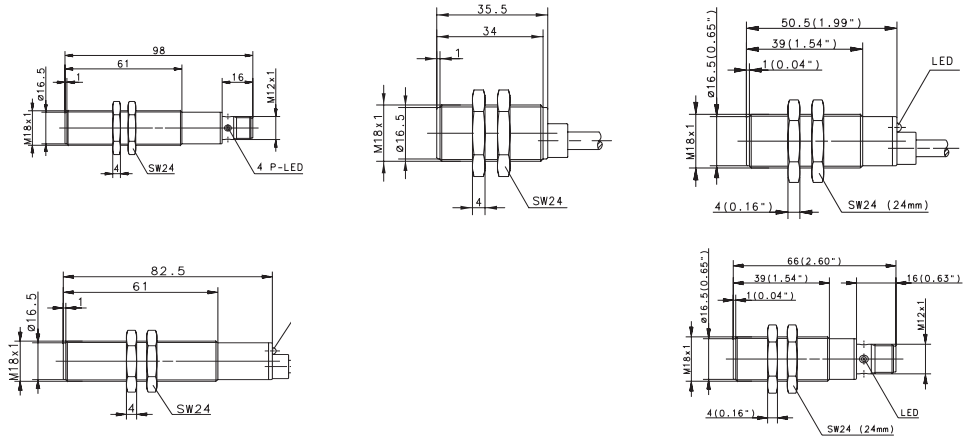

PNP	DC	NO contact Type NC contact Type Antivalent NO/NC Type	6502940006 KIB-M18PS/005-KLS12T	6502905023 KIB-M18PS/005-KL2PUT		6502905022 KIB-M18PS/008-KL2E	6502940005 KIB-M18PS/008-KLS12E
NPN	DC	NO contact Type NC contact Antivalent NO/NC Type					
PNP/NPN	DC	NO/NC prog. push-pull operation					
NAMUR	DC	Type			6501626762 KIB-M18EA/005-2		
Analogue	DC						
2-wire	DC	NO contact NC contact					
	AC	NO contact Type NC contact Type Changeover contact					

Technical data

Rated operating voltage	U_B	10–30 VDC	10–30 VDC	5–25 VDC	10–36 VDC	10–36 VDC
Rated operating current	I_B	≤ 200 mA	≤ 200 mA	–	≤ 200 mA	≤ 200 mA
Switching frequency (max)	F	500 Hz	500 Hz	≤ 400 Hz	500 Hz	500 Hz
Short circuit-protection		Cyclic	Cyclic	–	Cyclic	Cyclic
Function/operating voltage indicator		LED/–	LED/–	–/–	LED/–	LED/–
Sensing distance, adjustable						

Mechanical data

Ambient temperature (min/max)	–40°C/+100°	–40°C/+100°	–25°C/+70°C	–25°C/+70°C	–25°C/+70°C
Protection class in accordance with IEC 529, EN 60529	IP67	IP67	IP67	IP67	IP67
Enclosure material	CuZn39Pb3	CuZn39Pb3	CuZn39Pb3	CuZn39Pb3	CuZn39Pb3
Connection	M12 x 1	3 x 0.5 mm ²	2 x 0.5 mm ²	3 x 0.5 mm ²	M12 x 1

Please refer to Accessories for cable couplers, mounting brackets and sensor tester.



Inductive Sensors (Type M18)

Type	M18		M18		M18
Type of installation	Non-flush	Non-flush	Non-flush	Non-flush	Non-flush
Nominal sensing distance	8 mm	8 mm	8 mm	8 mm	8 mm
Type of connection	Cable 2 m	Connector M12	Cable 2 m	Cable 2 m	Cable 2 m
Special feature	Plastic			Plastic	

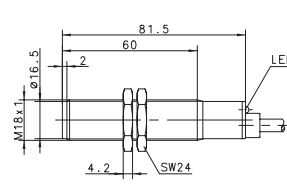
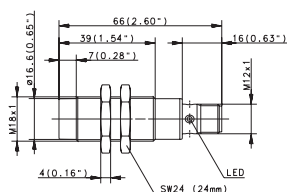
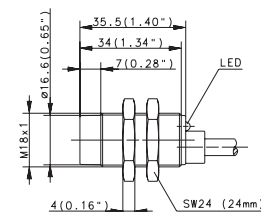
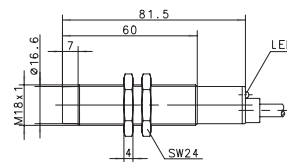
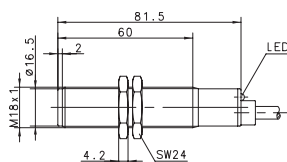

PNP	DC	NO contact Type NC contact Type Antivalent NO/NC Type	6932906004 KIN-M18PS/008-KLS12 6932706002 KIN-M18PÖ/008-KLS12	6502921975 KIN-T18PS/008-KL2	6502906006 KIN-M18PS/008-KL2V 6502706002 KIN-M18PÖ/008-KL2V
NPN	DC	NO contact Type NC contact Antivalent NO/NC	6932306004 KIN-M18NS/008-KLS12		6502306004 KIN-M18NS/008-KL2V
PNP/NPN	DC	NO/NC prog. push-pull operation			
NAMUR	DC				
Analogue	DC	Type			
2-wire	DC	NO contact NC contact Type	6503521705 KIN-T18AS/008-L2 6503421704 KIN-T18AÖ/008-L2	6501306001 KIN-M18ZS/008-L2	
	AC	NO contact Type NC contact Type Changeover contact			

Technical data

Rated operating voltage	U_B	24–250 V AC	10–36 VDC	10–60 VDC	10–60 VDC	10–60 VDC
Rated operating current	I_B	≤ 200 mA	≤ 200 mA	≤ 200 mA	≤ 200 mA	≤ 200 mA
Switching frequency (max)	F	≈ 10 Hz	200 Hz	200 Hz	200 Hz	200 Hz
Short circuit-protection		–	Cyclic	–	Cyclic	Cyclic
Function/operating voltage indicator		LED/–	LED/–	LED/–	LED/–	LED/–
Sensing distance, adjustable						

Mechanical data

Ambient temperature (min/max)		–25°C/+70°C	–25°C/+70°C	–25°C/+70°C	–25°C/+70°C	–25°C/+70°C
Protection class in accordance with IEC 529, EN 60529		IP67	IP67	IP67	IP67	IP67
Enclosure material		PA, red	CuZn39Pb3	CuZn39Pb3	PA, red	CuZn39Pb3
Connection		2 x 0.5 mm ²	M12 x 1	2 x 0.5 mm ²	3 x 0.5 mm ²	3 x 0.5 mm ²

Please refer to Accessories for cable couplers, mounting brackets and sensor tester.



M18		M18		M18	
Non-flush 8 mm DIN Connector	Non-flush 8 mm DIN Connector	Non-flush 8 mm Connector M12 Ultralock	Non-flush 8 mm Cable 2 m	Non-flush 8 mm Connector M12	

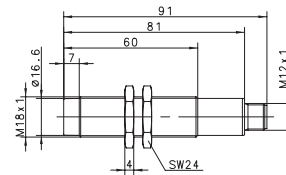
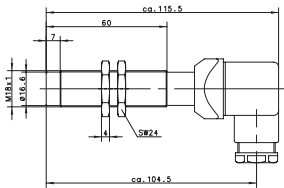
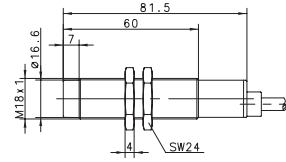
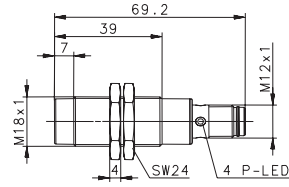
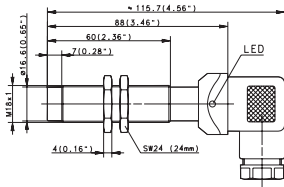

6502941001 KIN-M18PS/008-KLSD					
6502741001 KIN-M18PÖ/008-KLSD	6602841421 KIN-M18PU/008-KSD				
		6502306011 KIN-M18NS/008-KLS12U			
			6502006001 KIN-M18PA/008-2	6602006111 KIN-M18PA/008-S12	

10–60 VDC	10–60 VDC	10–36 VDC	10–36 VDC	10–36 VDC
≤ 200 mA	≤ 200 mA	≤ 200 mA	–	–
200 Hz	200 Hz	200 Hz	–	–
Cyclic	–	Cyclic	Cyclic	–
LED/–	–/–	LED/–	–/–	–/–

–25°C/+70°C	–40°C/+80°C	–25°C/+70°C	–25°C/+70°C	–25°C/+70°C
IP65	IP65	IP67	IP67	IP67
CuZn39Pb3	CuZn39Pb3	CuZn39Pb3	CuZn39Pb3	CuZn39Pb3
DIN 43650	DIN 43650	M12 x 1	3 x 0.5 mm ²	M12 x 1

You will find detailed data sheets to the products under www.bernstein.eu



Inductive Sensors (Type M18, M30)

Type	M18		M30		M30	
Type of installation	Non-flush	Non-flush	Flush	Flush	Flush	Flush
Nominal sensing distance	16 mm	16 mm	10 mm	10 mm	10 mm	10 mm
Type of connection	Cable 2 m	Connector M12	Cable 2 m	Cable 2 m	Connector M12	Cable 2 m
Special feature	Sensing dist.	Sensing dist.				

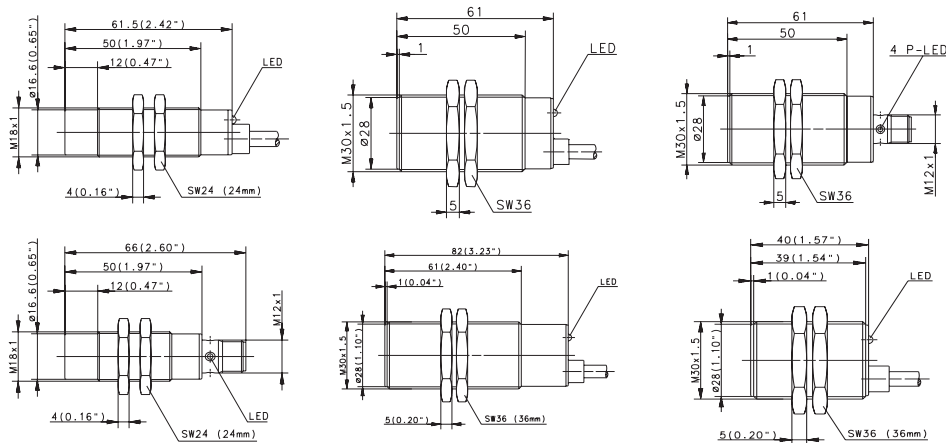

PNP	DC	NO contact Type NC contact Type Antivalent NO/NC	6502906018 KIN-M18PS/016-KL2E	6502941004 KIN-M18PS/016-KLS12E	6932907001 KIN-M18PS/016-KLS12E	6932907002 KIB-M30PS/010-KLS12	6502907003 KIB-M30PS/010-KL2V 6502707001 KIB-M30PÖ/010-KL2V
NPN	DC	NO contact Type NC contact Antivalent NO/NC					
PNP/NPN	DC	NO/NC prog. Type push-pull operation					
NAMUR	DC						
Analogue	DC	Type					
2-wire	DC	NO contact NC contact Type					
	AC	NO contact Type NC contact Type Changeover contact			6503507378 KIB-M30AS/010-L2 6503407240 KIB-M30AÖ/010-L2		

Technical data

Rated operating voltage	U_B	10–36 VDC	10–36 VDC	10–36 VDC	20–250 V AC	10–36 VDC	10–60 VDC
Rated operating current	I_B	≤ 200 mA	≤ 200 mA	≤ 200 mA	≤ 400 mA	≤ 200 mA	≤ 200 mA
Switching frequency (max)	F	200 Hz	200 Hz	300 Hz	≈ 10 Hz	300 Hz	300 Hz
Short circuit-protection		Cyclic	Cyclic	Cyclic	–	Cyclic	Cyclic
Function/operating voltage indicator		LED/–	LED/–	LED/–	LED/–	LED/–	LED/–
Sensing distance, adjustable							

Mechanical data

Ambient temperature (min/max)		–25°C/+70°C	–25°C/+70°C	–25°C/+70°C	–25°C/+70°C	–25°C/+70°C	–25°C/+70°C
Protection class in accordance with IEC 529, EN 60529		IP67	IP67	IP67	IP67	IP67	IP67
Enclosure material		CuZn39Pb3	CuZn39Pb3	CuZn39Pb3	CuZn39Pb3	CuZn39Pb3	CuZn39Pb3
Connection		3 x 0.5 mm ²	M12 x 1	3 x 0.5 mm ²	2 x 0.5 mm ²	M12 x 1	3 x 0.5 mm ²

Please refer to Accessories for cable couplers, mounting brackets and sensor tester.



M30		M30		M30	
Flush	Flush	Flush	Flush	Flush	Flush
10 mm	10 mm	10 mm	10 mm	10 mm	10 mm
Cable 2 m	DIN Connector	DIN Connector	DIN Connector	Cable 2 m	Connector M12
Plastic	Plastic			Temperature	Temperature

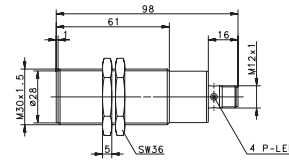
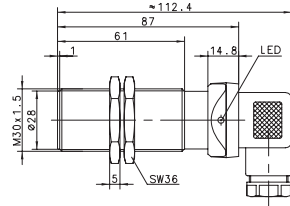
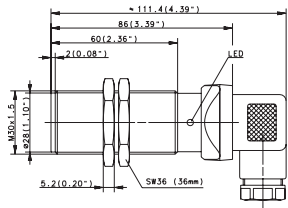
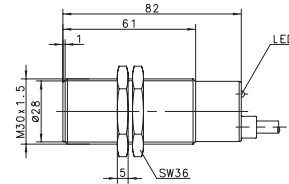
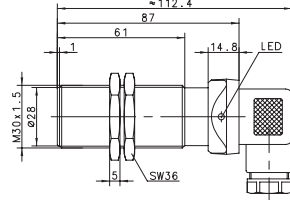
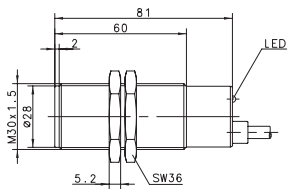

6502722708 KIB-T30PÖ/010-KL2	6502939001 KIB-M30PS/010-KLSD	6502907013 KIB-M30PS/010-KL2PUT	6502939006 KIB-M30PS/010-KLS12T
6502822862 KIB-T30PP/010-KLSD			
	6503535960 KIB-M30AS/010-LSD		
	6503435959 KIB-M30AÖ/010-LSD		

10–60 VDC	10–60 VDC	10–60 VDC	20–265 V AC	10–30 VDC	10–30 VDC
≤ 200 mA	≤ 200 mA	≤ 200 mA	≤ 500 mA	≤ 200 mA	≤ 200 mA
300 Hz	300 Hz	300 Hz	20 Hz	300 Hz	300 Hz
Cyclic	Cyclic	Cyclic	–	Cyclic	Cyclic
LED/–	LED/–	LED/–	LED/–	LED/–	LED/–

–25°C/+70°C	–25°C/+70°C	–25°C/+70°C	–25°C/+70°C	–40°C/+100°	–40°C/+100°
IP67	IP65	IP65	IP65	IP67	IP67
PA, red	PA, red	CuZn39Pb3	CuZn39Pb3	CuZn39Pb3	CuZn39Pb3
3 x 0.5 mm ²	DIN 43650	DIN 43650	DIN 43650	3 x 0.5 mm ²	M12 x 1

You will find detailed data sheets to the products under www.bernstein.eu



Inductive Sensors (Type M30)

Type	M30	M30	M30	M30
Type of installation	Flush	Non-flush	Non-flush	Non-flush
Nominal sensing distance	10 mm	15 mm	15 mm	15 mm
Type of connection	Cable 2 m	Cable 2 m	Cable 2 m	Cable 2.5 m
Special feature	NAMUR			Connector M12

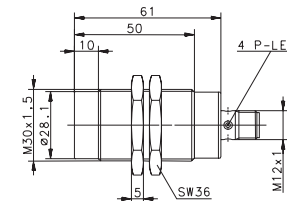
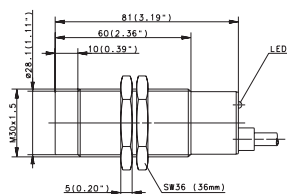
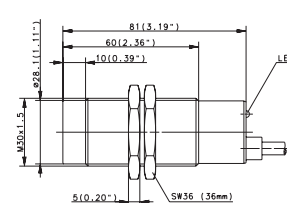
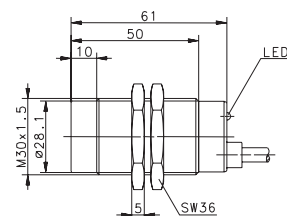
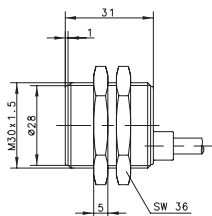

PNP	DC	NO contact Type NC contact Type Antivalent NO/NC Type		6932908001 KIN-M30PS/015-KL2	6502908002 KIN-M30PS/015-KL2		6932908002 KIN-M30PS/015-KLS12 6602308459 KIN-M30NS/015-KLS12
NPN	DC	NO contact Type NC contact Type Antivalent NO/NC			6502808001 KIN-M30PU/015-KL2		
PNP/NPN	DC	NO/NC prog. Type push-pull operation			6502308001 KIN-M30NS/015-KL2		
NAMUR	DC	Type	6501699012 KIB-M30EA/010-2				
Analogue	DC	Type					
2-wire	DC	NO contact NC contact					
	AC	NO contact Type NC contact Changeover contact				6503508246 KIN-M30AS/015-L2,5	

Technical data

Rated operating voltage	U_B	5–25 VDC	10–36 VDC	10–60 VDC	20–250 V AC	10–36 VDC
Rated operating current	I_B	–	≤ 200 mA	≤ 200 mA	≤ 400 mA	≤ 200 mA
Switching frequency (max)	F	≤ 300 Hz	100 Hz	100 Hz	≈ 10 Hz	100 Hz
Short circuit-protection		–	Cyclic	Cyclic	–	Cyclic
Function/operating voltage indicator		–/–	LED/–	LED/–	LED/–	LED/–
Sensing distance, adjustable						

Mechanical data

Ambient temperature (min/max)		–25°C/+70°C	–25°C/+70°C	–25°C/+70°C	–25°C/+70°C	–25°C/+70°C
Protection class in accordance with IEC 529, EN 60529		IP67	IP67	IP67	IP67	IP67
Enclosure material		CuZn39Pb3	CuZn39Pb3	CuZn39Pb3	CuZn39Pb3	CuZn39Pb3
Connection		2 x 0.5 mm ²	3 x 0.5 mm ²	3 x 0.5 mm ²	2 x 0.5 mm ²	M12 x 1

Please refer to Accessories for cable couplers, mounting brackets and sensor tester.



Inductive Sensors (Type Ø 34 mm, 5 x 5, 8 x 8, 12 x 12, 27 x 10, 28 x 16)

Type	Ø 34 mm	5 x 5 x 25 mm	8 x 8 x 40 mm		8 x 8 x 56 mm
Type of installation	Non-flush	Flush	Flush	Flush	Flush
Nominal sensing distance	20.0 mm	1.5 mm	1.5 mm	1.5 mm	1.5 mm
Type of connection	Cable 2 m	Cable	Cable 2 m	Cable 2 m	Connector M8
Special feature					

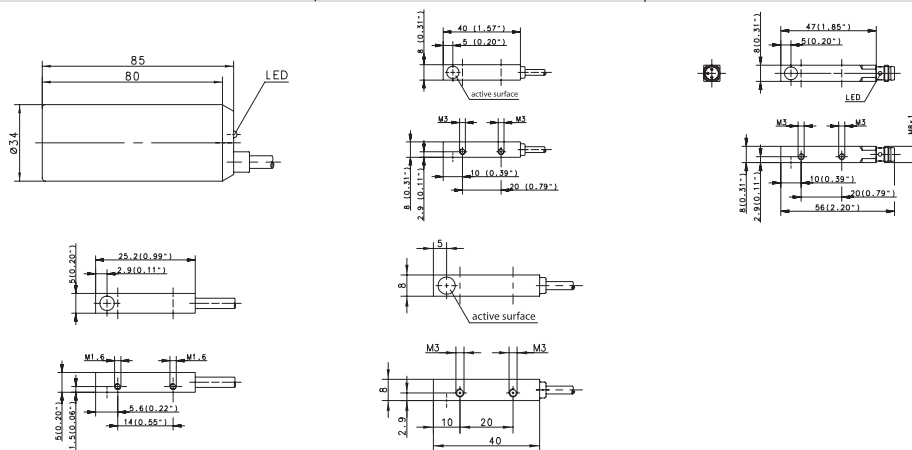

PNP	DC	NO contact Type NC contact Type Antivalent NO/NC	6502915002 KIN-R34PS/020-KL2	6502999026 KIB-Q05PS/001-K2PU 6502799010 KIB-Q05PÖ/001-K2PU	6502980004 KIB-Q08PS/1,5-K2 6502780001 KIB-Q08PÖ/1,5-K2	6602980087 KIB-Q08PS/1,5-K2T	6502980002 KIB-Q08PS/1,5-KLSM8 6502780002 KIB-Q08PÖ/1,5-KLSM8
NPN	DC	NO contact Type NC contact Type Antivalent NO/NC					
PNP/NPN	DC	NO/NC prog. Type push-pull operation	6502915001 KIN-R34PP/020-KLSD				
NAMUR	DC						
Analogue	DC						
2-wire	DC	NO contact NC contact					
	AC	NO contact NC contact Changeover contact					

Technical data

Rated operating voltage	U_B	10–60 VDC	10–30 VDC	10–36 VDC	10–36 VDC	10–36 VDC
Rated operating current	I_B	≤ 200 mA	200 mA	≤ 200 mA	≤ 200 mA	≤ 200 mA
Switching frequency (max)	F	100 Hz	1000 Hz	1000 Hz	1000 Hz	1000 Hz
Short circuit-protection		Cyclic	Cyclic	Cyclic	Cyclic	Cyclic
Function/operating voltage indicator		LED/-	-/-	-/-	-/-	LED/-
Sensing distance, adjustable						

Mechanical data

Ambient temperature (min/max)		-25°C/+70°C	-25°C/+70°C	-25°C/+70°C	0°C/+100°C	-25°C/+70°C
Protection class in accordance with IEC 529, EN 60529		IP67	IP67	IP67	IP67	IP67
Enclosure material		PBT, red	CuZn39PB3	CuZn39PB3	CuZn39PB3	CuZn39PB3
Connection		3 x 0.5 mm ²	3 x 0.05 mm ²	3 x 0.14 mm ²	3 x 0.14 mm ²	M8 x 1

Please refer to Accessories for cable couplers, mounting brackets and sensor tester.



12 x 12 x 55 mm		27 x 10 x 5 mm	28 x 16 x 11 mm		
Flush	Flush	Flush	Flush	Flush	
4 mm	4 mm	1.5 mm	2 mm	2 mm	
Cable 2 m	Connector M8	Cable 2 m	Cable 2 m	Connector M8	

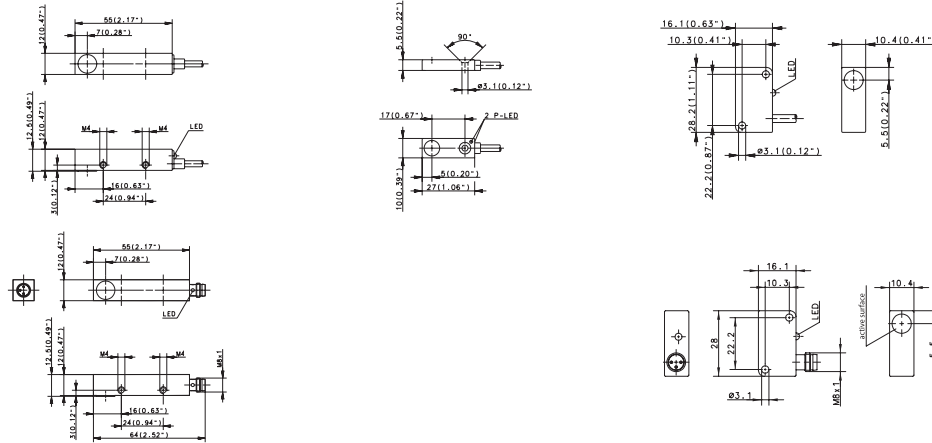

6502999028 KIB-Q12PS/004-KL2E	6502999030 KIB-Q12PS/004-KLSM8E	6502993001 KIB-E27PS/1,5-KL2PU	6502973001 KIB-E28PS/002-KL2	6502973002 KIB-E28PS/002-KLSM8 6502773001 KIB-E28PÖ/002-KLSM8			
	6502399021 KIB-Q12NS/004-KLSM8E						

10–60 VDC	10–60 VDC	10–30 VDC	10–30 VDC	10–30 VDC	
≤ 200 mA	≤ 200 mA	≤ 200 mA	≤ 200 mA	≤ 200 mA	
800 Hz	800 Hz	1000 Hz	800 Hz	800 Hz	
Cyclic	Cyclic	Cyclic	Cyclic	Cyclic	
LED/-	LED/-	LED/-	LED/-	LED/-	

-25°C/+70°C	-25°C/+70°C	-25°C/+70°C	-25°C/+70°C	-25°C/+70°C	
IP67	IP67	IP67	IP67	IP67	
CuZn39Pb3	CuZn39Pb3	PA, black	PA, black	PA, black	
3 x 0.14 mm ²	M8 x 1	3 x 0.14 mm ²	3 x 0.14 mm ²	M8 x 1	

You will find detailed data sheets to the products under www.bernstein.eu



Inductive Sensors (Type 28 x 16 mm, 40 x 26 mm, 50 x 25 mm, 60 x 36 mm)

Type	40 x 26 x 12 mm	40 x 26 x 12 mm	40 x 26 x 12 mm	40 x 26 x 12 mm	40 x 26 x 12 mm
Type of installation	Flush	Flush	Non-flush	Non-flush	Non-flush
Nominal sensing distance	2 mm	2 mm	4 mm	4 mm	4 mm
Type of connection	Cable 2 m	Connector M8	Cable 2 m	Cable 2 m	Connector M8
Special feature					

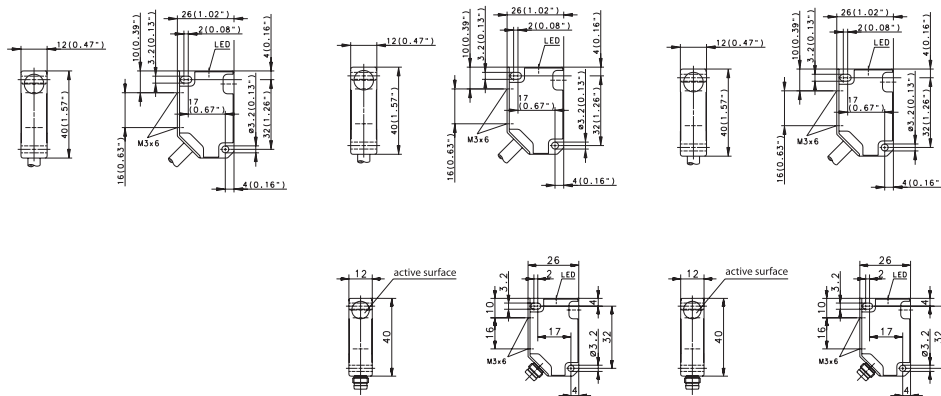

PNP	DC	NO contact Type NC contact Type Antivalent NO/NC Type	6502984023 KIB-E40PS/002-KL2 6502784006 KIB-E40PÖ/002-KL2	6502984025 KIB-E40PS/002-KLSM8	6502984024 KIN-E40PS/004-KL2 6502784007 KIN-E40PÖ/004-KL2	6502984026 KIN-E40PS/004-KLSM8 6502784008 KIN-E40PÖ/004-KLSM8
NPN	DC	NO contact Type NC contact Type Antivalent NO/NC				
PNP/NPN	DC	NO/NC prog. Type push-pull operation				
NAMUR	DC	Type				
Analogue	DC	Type				
2-wire	DC	NO contact NC contact				
	AC	NO contact Type NC contact Changeover contact				6503584005 KIN-E40AS/004-L2

Technical data

Rated operating voltage	U_B	10–36 VDC	10–36 VDC	10–36 VDC	20–250 V AC	10–36 VDC
Rated operating current	I_B	≤ 200 mA	≤ 200 mA	≤ 200 mA	≤ 300 mA	≤ 200 mA
Switching frequency (max)	F	800 Hz	800 Hz	400 Hz	10 Hz	400 Hz
Short circuit-protection		Cyclic	Cyclic	Cyclic	–	Cyclic
Function/operating voltage indicator		LED/–	LED/–	LED/–	LED/–	LED/–
Sensing distance, adjustable						

Mechanical data

Ambient temperature (min/max)		–25°C/+70°C	–25°C/+70°C	–25°C/+70°C	–25°C/+70°C	–25°C/+70°C
Protection class in accordance with IEC 529, EN 60529		IP67	IP67	IP67	IP67	IP67
Enclosure material		PBT, black	PBT, black	PBT, black	PBT, black	PBT, black
Connection		3 x 0.5 mm ²	M8 x 1	3 x 0.5 mm ²	2 x 0.5 mm ²	M8 x 1

Please refer to Accessories for cable couplers, mounting brackets and sensor tester.



50 x 25 x 10 mm		50 x 25 x 10 mm		60 x 36 x 10 mm	
Flush	Flush	Non-flush	Non-flush	Non-flush	
5 mm	5 mm	8 mm	8 mm	8 mm	
Cable 2 m	Connector M8	Cable 2 m	Connector M8	Connector M8	

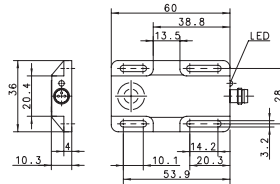
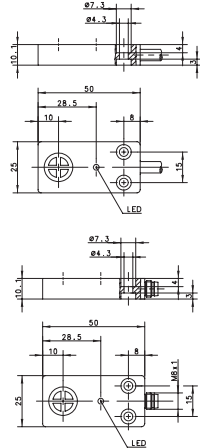
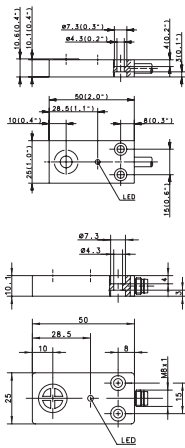

6502990001 KIB-E50PS/005-KL2	6502990005 KIB-E50PS/005-KLSM8	6502990003 KIN-E50PS/008-KL2	6502990006 KIN-E50PS/008-KLSM8	6602799048 KIN-E60PÖ/008-KLSM8		
6502390001 KIB-E50NS/005-KL2		6502390002 KIN-E50NS/008-KL2				

10–60 VDC	10–60 VDC	10–60 VDC	10–60 VDC	10–60 VDC
≤ 200 mA	≤ 200 mA	≤ 200 mA	≤ 200 mA	≤ 400 mA
500 Hz	500 Hz	200 Hz	200 Hz	200 Hz
Cyclic	Cyclic	Cyclic	Cyclic	Cyclic
LED/–	LED/–	LED/–	LED/–	LED/–

–25°C/+70°C	–25°C/+70°C	–25°C/+70°C	–25°C/+70°C	–25°C/+70°C
IP67	IP67	IP67	IP67	IP67
PA, black	PA, black	PA, black	PA, black	PA, black
3 x 0.5 mm ²	M8 x 1	3 x 0.5 mm ²	M8 x 1	M8 x 1

You will find detailed data sheets to the products under www.bernstein.eu



Inductive Sensors (Type 68 x 30 mm, 40 x 40 mm)

Type	68 x 30 x 15 mm	40 x 40 mm	40 x 40 mm	
Type of installation	Non-flush	Non-flush	Non-flush	Non-flush
Nominal sensing distance	7 mm	20 mm	15 mm	0 mm
Type of connection	Cable 2 m	Connector M12	DIN Connector	Cable 6 m
Special feature				Ring sensor

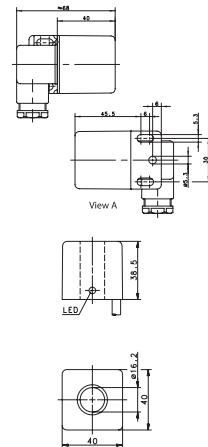
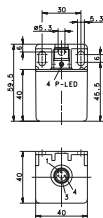
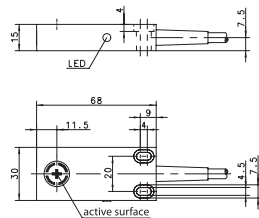

PNP	DC	NO contact Type NC contact Type Antivalent NO/NC	6502956076 KIN-E68PS/007-KL2	6502982003 KIN-N40PS/020-KLS12	6502999036 KIR-N40PS/000-KL6
NPN	DC	NO contact Type NC contact Type Antivalent NO/NC	6502156058 KIN-E68NÖ/007-KL6		
PNP/NPN	DC	NO/NC prog. Type push-pull operation			6502982001 KIN-N40PP/015-KLSD
NAMUR	DC				
Analogue	DC				
2-wire	DC	NO contact NC contact			
	AC	NO contact NC contact Changeover contact			

Technical data

Rated operating voltage	U_B	10–60 VDC	10–36 VDC	10–60 VDC	10–30 VDC
Rated operating current	I_B	≤ 200 mA	≤ 200 mA	≤ 400 mA	≤ 200 mA
Switching frequency (max)	F	200 Hz	50 Hz	100 Hz	–
Short circuit-protection		Cyclic	Cyclic	Cyclic	Cyclic
Function/operating voltage indicator		LED/–	LED/–	LED/–	LED/–
Sensing distance, adjustable					

Mechanical data

Ambient temperature (min/max)		–25°C/+70°C	–25°C/+70°C	–25°C/+70°C	–25°C/+70°C
Protection class in accordance with IEC 529, EN 60529		IP67	IP67	IP65	IP67
Enclosure material		PBT, black	PA, red/black	PA, red	PA, black
Connection		3 x 0.5 mm ²	M12 x 1	DIN 43650	3 x 0.5 mm ²

Please refer to Accessories for cable couplers, mounting brackets and sensor tester.



Capacitive Sensors

Functional principle

Capacitive proximity switches detect conductive and non-conductive materials that can be in a solid or liquid state. They serve the purpose of monitoring product levels in containers, checking contents in filling and packaging systems as well as detecting, positioning, monitoring and counting objects, e.g. in sequence control systems, conveyor belts.

Used for detecting media such as:

- **solid:**
wood, ceramic, glass, paper stacks, plastic, stone, rubber, ice, nonferrous metals, potatoes
- **liquid:**
water, oil, beverages, adhesives, paints
- **granular:**
plastic pellets, granulated products, grain, fodder, wood chip
- **powder:**
dyes, detergents, sand, cement, fertilizer, salt, sugar, flour, coffee

Technical description

The function of the capacitive proximity switch is based on evaluating the influence exerted by an actuator on the electrical field at the active face of the switch. The approach of an influencing object increases the capacitance of the capacitor, which consists of a sensor electrode located behind the active face and the actuator connected to earth / mass. This increase in capacitance is dependent on the conductance and the dielectric constant of the actuator as well as its mass, surface area and its distance from the sensor electrode. The capacitive limit switch is equipped with an RC oscillator with a gain factor that increases as a result of the rise in capacitance of the previously described capacitor to such an extent that oscillation is induced. In limit switches, the capacitance required to induce oscillation can be determined by the built-in potentiometer intervening in the feedback of the oscillator.

The response sensitivity, i.e. the sensing distance with a given actuator can be adjusted in this way. The oscillator output signal is fed to an evaluation circuit that actuates the switching amplifier.

In response to the approach of **conductive** material the actuating object and the active face of the sensor form the plates of a capacitor. The change in capacitance and the consequently achievable sensing distance are large.

In response to the approach of **non-conductive** material $\epsilon > 1$ only the change in the dielectric constant is effective. The increase in capacitance is less than is the case for conductive materials. The resulting sensing distance is small.

Sensitivity table	
St37 or other metals, earthed	1.00
Surface of water	1.00
St37 150 x 150 x 1 mm, not earthed	0.85
Marble 150 x 150 x 12.5 mm	0.65
Glass 150 x 150 x 7.5 mm	0.55
Stack of paper DIN A 4, 80 g/m ² , 500 sheets	0.55
Fibre board 150 x 150 x 16 mm	0.45
Ceramic tile 150 x 150 x 6 mm	0.25
PVC 150 x 150 x 4 mm	0.15

These values only indicate the expected magnitude of the response sensitivity as the specific properties of the actuating object and of the surroundings in actual applications have a considerable influence on the response distance. It is important to take into account the influence of moisture in order to ensure trouble-free operation. A high water content in the material to be detected, e.g. wood or paper, increases the sensing distance considerably.

In terms of capacitive proximity switches a distinction is made between

- flush mount and
 - non-flush mount
- limit switches.

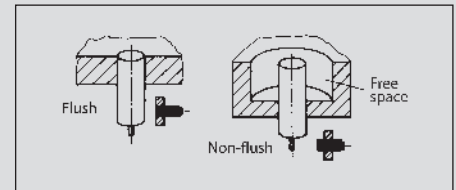

In the case of non-flush mount limit switches a clearance that must contain no influencing material must be created about the switch. Due to the adjustment facility available in capacitive proximity switches, the installation of non-flush mount devices is not problematic in connection with reduced clearance. Non-flush mount capacitive proximity switches are characterised by low sensitivity to soiling or condensation.

A screening electrode built into flush mount limit switches is connected to circuit ground. As both electrodes of the capacitor are now close together, flush mount capacitive proximity switches are particularly suitable for sensing dielectrics. The disadvantage is that this configuration has an increased sensitivity to condensation or soiling.

Capacitive proximity switches can mutually influence each other if they are mounted next to or opposite each other. In such configurations, the response of flush mount switches is considerably less sensitive than non-flush mount switches. Trials under actual application conditions should be carried out at distances from $> 2x$ to $< 8x$ enclosure diameter. Arrangements with distances $> 8x$ enclosure diameter are not problematic.

Active face: The active face of a capacitive proximity switch is the point at which the electrical field emerges. This point is located at the end face on types designed as threaded sleeves or smooth cylinders. Non-cylindrical limit switches are identified by a symbol on the corresponding face.

Influencing: In relation to a capacitive proximity switch the term influencing refers to the change in the switching status in response to the medium to be detected entering the electrical field.

Standard target: The standard target is defined as a square plate, 1 mm thick and made from FE 360.

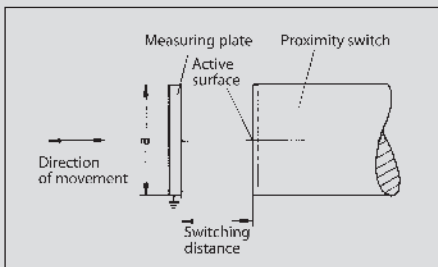

The side length "a" of the square target corresponds to the diameter of the circle described by the active face. The length of its side is defined as the larger of either the active face diameter or three times the nominal sensing distance. The target must be earthed in order to ensure comparable sensing distances. The sensing distance of rectangular, capacitive proximity switches is determined by means of an earthed target with a size equal to the surface of the active side of the limit switch.

Sensing distance: The sensing distance, that changes the status of the output stage, is the distance of the influencing object in relation to the active face.

Nominal sensing distance (s_n): This is a device-specific characteristic value that does not take into account influences such as tolerance, temperature and changes in voltage.

Real sensing distance (s_r): The real sensing distance is measured at a rated voltage and an ambient temperature of 23 °C +/- 5 °C. It must be between 90 % and 110 % of the nominal sensing distance.

Useable sensing distance (s_u): The useable sensing distance is measured within the permissible temperature and voltage ranges and is 80 % – 120 % of the real sensing distance.

Assured sensing distance (s_a) (operational sensing distance): This is the distance that can be used effectively under the influence of temperature, voltage as well as tolerance variables. It is between 0 % and 72 % of the nominal sensing distance.

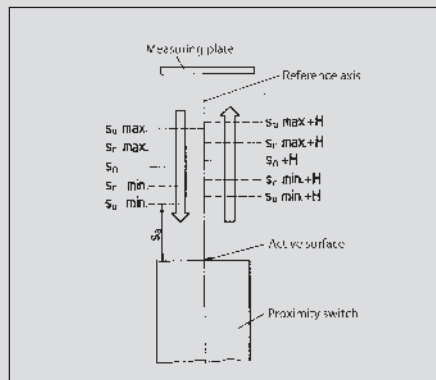

Reproducibility: The reproducibility of the switching distance is the repeat accuracy of the real sensing distance of two successive switching operations within a period of 8 hours at an ambient temperature between 18 °C and 28 °C and a supply voltage that may not deviate by more than 5 % from the rated voltage. The difference between any two measurements must not be more than 10 % of the real sensing distance.

Switching hysteresis: The switching hysteresis refers to the difference between the switch-on point as an object approaches the target and the switch-off point as the object moves away from the proximity switch. The value is specified as a percentage of the real sensing distance.

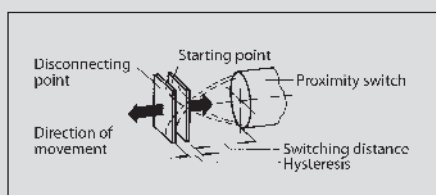

Switching frequency: The switching frequency is measured in accordance with EN 60947-5-2. The standard targets with the side length "a" are mounted on a plate that exerts minimum influence at "2a" intervals and are moved passed the proximity switch to be tested at half the nominal sensing distance. The maximum switching frequency is reached when the switch-on or switch-off time of the proximity switch is 50 μs. In the case of AC proximity switches, the maximum switching frequency is reached when the switch-on and switch-off time is equal to the half wave period of the supply frequency.

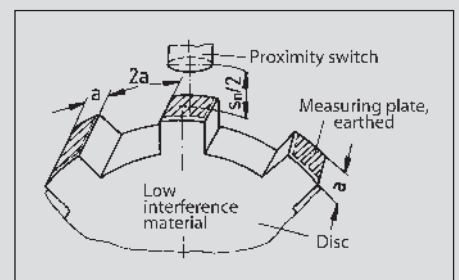

Temperature range: In accordance with DIN, the temperature range is from -25 °C to +70 °C. Reliable operation is ensured within this range.

Protection class

Corresponding to their ID code, the enclosures are dustproof and waterproof in accordance with IP65 or IP67 (DIN 40050).

Connection cable

A PVC-insulated connection cable is supplied as standard. Special versions with silicone sheathing, polyurethane sheathing, irradiation cross-linked PVC or Teflon insulation are also available.

Plug connection

Nowadays the plug connection is just as significant as the fixed cable on electronic proximity switches. The capacitive proximity switches in the BERNSTEIN range can be equipped with a wide variety of plug connections. As standard, this catalogue contains connector versions of virtually all types of limit switch.

Standards

All sensors conform to EN 60947-5-2



Capacitive Sensors

Important information

Capacitive sensors are able to detect conductive and non-conductive materials in solid, liquid, granular or powder form. However, certain criteria must be taken into account in practical applications.

Sensing distance

The nominal sensing distances are specified and set at the factory in accordance with DIN EN 60947-5-2/98. The maximum sensing distance is achieved on approach of **conductive** materials of corresponding size.

On approach of **non-conductive** materials, the dielectric constant ϵ of the material to be detected is of decisive significance. Depending on the application, the specified sensing distances vary by a certain factor in relation to the dielectric constant. The values determined according to the table only indicate the expected magnitude of the response sensitivity as the specific properties of the actuating object (diameter, thickness, moisture content etc.) and of the surroundings (earthing) in actual applications have a considerable influence on the response distance. In most cases adaptation to the specific application can be achieved by adjustment with the built-in potentiometer.

Clearance

In the case of non-flush mount capacitive sensors a clearance that must contain no influencing material must be created about the sensor. Non-flush mount capacitive sensors are characterised by low sensitivity to soiling or condensation. On account of their design, flush mount capacitive sensors are particularly suitable for sensing dielectrics. The increased sensitivity, however, may be detrimental in terms of the above mentioned parasitic effects.

If capacitive proximity switches are to be mounted opposite or next to each other, trials under actual application conditions should be carried out at distances between 2x and 8x enclosure diameter. Thanks to the adjustment facility, however, adaptation to specific applications is almost always possible.

Examples of dielectric constants	
Glass	3 ... 14
Rubber	2.5 ... 3
Laminated paper	3.5 ... 6
Wood	2.5 ... 6.8
Marble	8.4 ... 14
Mineral oil	2.15
Epoxy resin	3.3 ... 3.6
Petroleum	2.2
Plexiglas	3.6
Polyamide	3 ... 8
PVC	3.3 ... 4.1
Porcelain	4.2 ... 6.5
Teflon PTFE	2
Air	1
Water	80.8
Paper (dry)	2

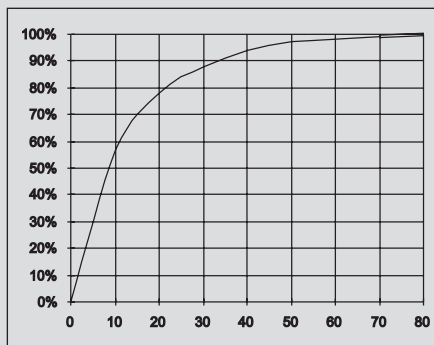

Variance of sensing distance as a function of ϵ







Application descriptions

A particular application of capacitive proximity switches is to detect levels in non-metallic containers from the outside. Advantage: There is no need to make a hole in the container wall for the purpose of detecting product level. The medium to be detected does not come in contact with the limit switch. The prerequisite is that the dielectric constant and the mass of the material to be detected are greater than that of the container. The response sensitivity of the proximity switch must be reduced with the built-in potentiometer to such an extent that the limit switch does not respond to the container wall but rather to the medium to be detected.

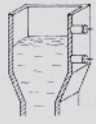
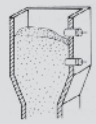
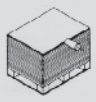

Above: Insulation glass production lines equipped with BERNSTEIN capacitive sensors

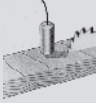
Further fields of application are illustrated below.

- 
Level monitoring in non-metallic containers
- 
Level monitoring of bulk material, e.g. granulated material, fodder
- 
Stack height scanning, e.g. paper, chip board
- 
Fill level monitoring in paint and adhesive containers
- 
Registering, counting, sorting or monitoring in conveyor belt systems
- 
Detecting, positioning in sequence control systems
- 
Detection in woodworking applications
- 
Belt breakage signalling
- 
Level monitoring in packing systems

Capacitive Sensors (Type M12, M18)

Type	M12		M12		M12
Type of installation	Flush	Flush	Non-flush	Non-flush	Non-flush
Nominal sensing distance	2 mm	2 mm	4 mm	4 mm	6 mm
Type of connection	Cable 2 m	Connector M8	Cable 2 m	Connector M8	Cable 2 m
Special feature					Sensing dist.

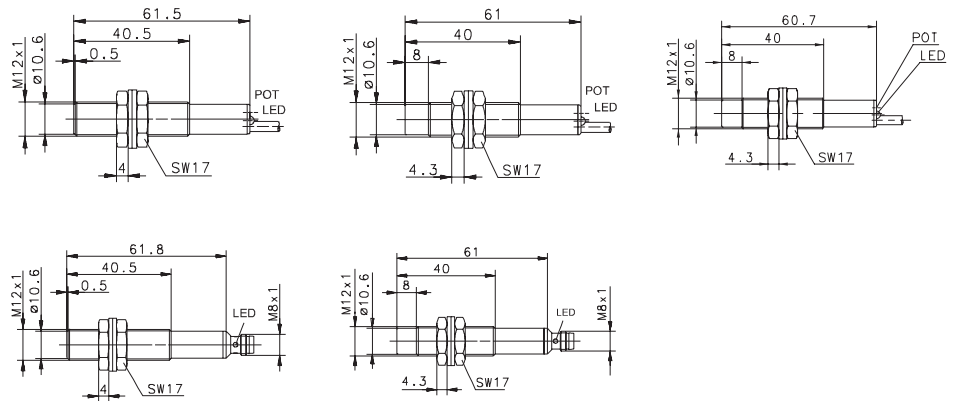

PNP	DC	NO contact	6507903001	6507903004	6507919001	6507919004	6607919110
		Type	KCB-M12PS/002-KLP2	KCB-M12PS/002-KLSM8	KCN-T12PS/004-KLP2	KCN-T12PS/004-KLSM8	
NPN	DC	NC contact	6507703001				
		Type	KCB-M12PÖ/002-KLP2				
PNP/NPN	DC	Antivalent NO/NC					
		Type					
NAMUR	DC	Antivalent NO/NC					
		Type					
Analogue	DC	NO/NC prog.					
		push-pull operation					
2-wire	DC	NO contact	6507303001		6507319001		
		NC contact	KCB-M12NS/002-KLP2		KCN-T12NS/004-KLP2		
2-wire	AC	NO contact					
		NC contact					
2-wire	AC	Changeover contact					
		Type					

Technical data

Rated operating voltage	U_B	10–36 VDC	10–36 VDC	10–36 VDC	10–36 VDC	10–36 VDC
Rated operating current	I_e	≤ 200 mA	≤ 200 mA	≤ 200 mA	≤ 200 mA	≤ 200 mA
Switching frequency (max)	F	25 Hz	25 Hz	25 Hz	25 Hz	25 Hz
Short circuit-protection		Cyclic	Cyclic	Cyclic	Cyclic	Cyclic
Function/operating voltage indicator		LED/–	LED/–	LED/–	LED/–	LED/–
Sensing distance, adjustable		Poti	–	Poti	–	Poti

Mechanical data

Ambient temperature (min/max)		–25°C/+70°C	–25°C/+70°C	–25°C/+70°C	–25°C/+70°C	–25°C/+70°C
Protection class in accordance with IEC 529, EN 60529		IP65	IP65	IP65	IP65	IP65
Enclosure material		CuZn39Pb3	CuZn39Pb3	PBT, black	PBT, black	PBT, black
Connection		3 x 0.14 mm ²	M8 x 1	3 x 0.14 mm ²	M8 x 1	3 x 0.14 mm ²

Please refer to Accessories for cable couplers, mounting brackets and sensor tester.



M18		M18		M18	
Flush	Flush	Non-flush	Non-flush	Non-flush	Non-flush
5.0 mm	5.0 mm	8.0 mm	8.0 mm	8.0 mm	13.5 mm
Cable 2 m	Connector M8	Cable 2 m	Cable 2 m	Connector M8	Connector M12
					Sensing dist.

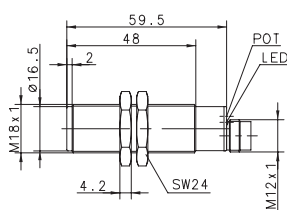
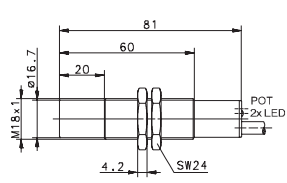
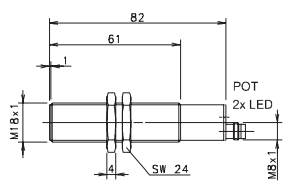
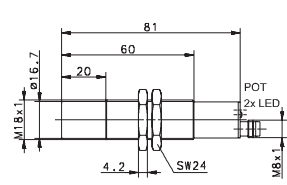
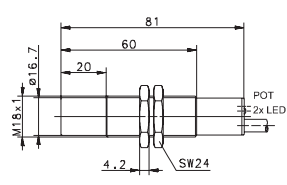
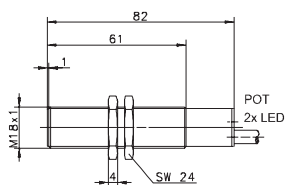

6507905001 KCB-M18PS/005-KLP2	6507905004 KCB-M18PS/005-KLPSM8	6507921724 KCN-T18PS/008-KLP2		6507921002 KCN-T18PS/008-KLPSM8	6507921004 KCN-T18PS/013-KLPS12V		
		6507821001 ^① KCN-T18PU/008-KLP2V					
6507305001 KCB-M18NS/005-KLP2		6507321723 KCN-T18NS/008-KLP2					
			6508521001 KCN-T18AS/008-LP2 6508421001 KCN-T18AÖ/008-LP2				

10–60 VDC	10–60 VDC	10–60 VDC	20–250 V AC	10–60 VDC	10–60 VDC
≤ 200 mA	≤ 200 mA	≤ 200 mA	≤ 300 mA	≤ 200 mA	≤ 200 mA
25 Hz	25 Hz	25 Hz	15 Hz	25 Hz	25 Hz
Cyclic	Cyclic	Cyclic	–	Cyclic	Cyclic
LED/LED	LED/LED	LED/LED	LED/LED	LED/LED	LED/LED
Poti	Poti	Poti	Poti	Poti	Poti

–25°C/+70°C	–25°C/+70°C	–25°C/+70°C	–25°C/+70°C	–25°C/+70°C	–25°C/+70°C
IP65	IP65	IP65	IP65	IP65	IP65
CuZn39Pb3	CuZn39Pb3	PBT, black	PBT, black	PBT, black	PBT, black
3 x 0.5 mm ²	M8 x 1	3 x 0.5 mm ²	2 x 0.5 mm ²	M8 x 1	M12 x 1

You will find detailed data sheets to the products under www.bernstein.eu

① Length 65 mm



Capacitive Sensors (Type M30, M32)

Type	M30		M30		M30	
Type of installation	Flush	Flush	Non-flush	Non-flush	Non-flush	Non-flush
Nominal sensing distance	10 mm	10 mm	20 mm	20 mm	20 mm	20 mm
Type of connection	Cable 2 m	Connector M12	Cable 2 m	Connector M12	Connector M12	Cable 2 m
Special feature					Short form	

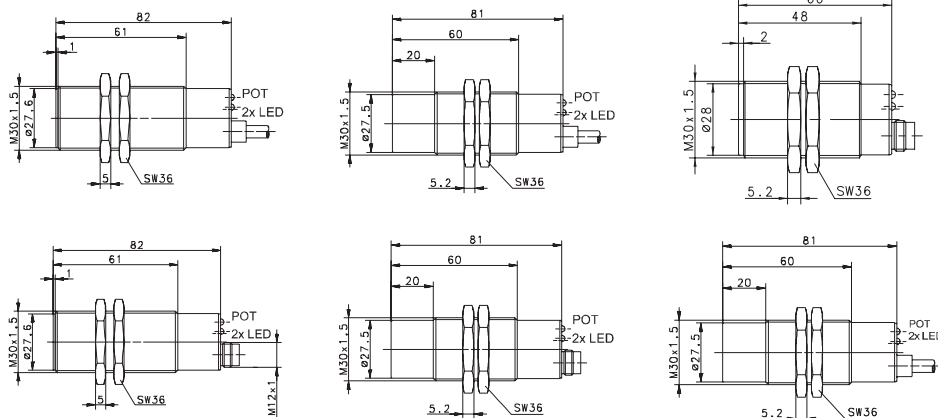

PNP	DC	NO contact Type NC contact Antivalent NO/NC Type	6507907001	6507907004	6507923727	6507923004	6507923006
			KCB-M30PS/010-KLP2	KCB-M30PS/010-KLPS12	KCN-T30PS/020-KLP2	KCN-T30PS/020-KLPS12	KCN-T30PS/020-KLPS12V
NPN	DC	NO contact Type NC contact Antivalent NO/NC Type	6507707001		6507323001		
			KCB-M30PÖ/010-KLP2		KCN-T30NS/020-KLP2		
PNP/NPN	DC	NO/NC prog. Type push-pull operation Type					
NAMUR	DC						
Analogue	DC						
2-wire	DC	NO contact NC contact					
	AC	NO contact Type NC contact Type Changeover contact Type				6508523001 KCN-T30AS/020-LP2 6508423001 KCN-T30AÖ/020-LP2	

Technical data

Rated operating voltage	U_B	10–60 VDC	10–60 VDC	10–60 VDC	10–60 VDC	10–60 VDC	20–250 V AC
Rated operating current	I_o	≤ 400 mA	≤ 400 mA	≤ 400 mA	≤ 400 mA	≤ 400 mA	≤ 300 mA
Switching frequency (max)	F	25 Hz	25 Hz	25 Hz	25 Hz	25 Hz	15 Hz
Short circuit-protection		Cyclic	Cyclic	Cyclic	Cyclic	Cyclic	–
Function/operating voltage indicator		LED/LED	LED/LED	LED/LED	LED/LED	LED/LED	LED/LED
Sensing distance, adjustable		Poti	Poti	Poti	Poti	Poti	Poti

Mechanical data

Ambient temperature (min/max)		–25°C/+70°C	–25°C/+70°C	–25°C/+70°C	–25°C/+70°C	–25°C/+70°C	–25°C/+70°C
Protection class in accordance with IEC 529, EN 60529		IP65	IP65	IP65	IP65	IP65	IP65
Enclosure material		CuZn39Pb3	CuZn39Pb3	PBT, black	PBT, black	PBT, black	PBT, black
Connection		3 x 0.5 mm ²	M12 x 1	3 x 0.5 mm ²	M12 x 1	M12 x 1	2 x 0.5 mm ²

Please refer to Accessories for cable couplers, mounting brackets and sensor tester.



M30	M30	M32		M32	
Non-flush 20 mm Cable 2 m PTFE front cap	Non-flush 20 mm Cable 2 m Timer/Relay	Flush 15 mm Cable 6 m	Flush 15 mm Connector M12	Non-flush 30 mm Cable 2 m	Non-flush 30 mm Connector M12

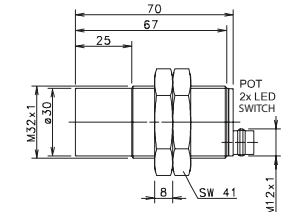
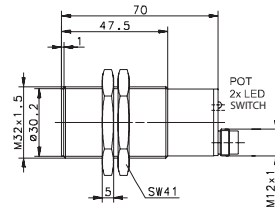
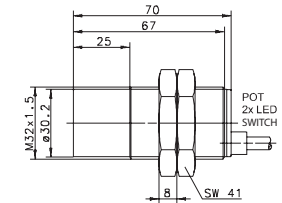
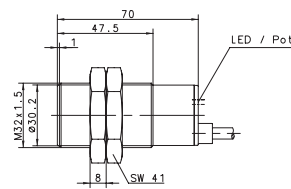
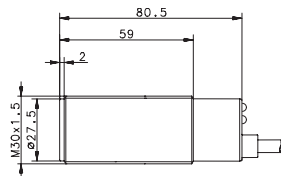
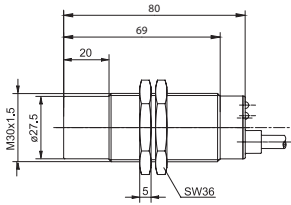

6507908001 KCN-M30PS/020-KLP2					
6507308001 KCN-M30NS/020-KLP2					
			6507013013 KCB-M32DP/015-KLP6 6507013012 KCB-M32GP/015-KLP2	6507013015 KCB-M32DP/015-KLPS12	6507013001 KCN-T32DP/030-KLP2 6507013004 KCN-T32DP/030-KLPS12
		6509023001 KCN-T30RU/020-LP2			

10–60 VDC ≤ 400 mA 25 Hz Cyclic LED/LED Poti	20–250 V AC ≤ 1 A – – LED/LED Poti	10–60 VDC ≤ 400 mA 25 Hz Cyclic LED/LED Poti	10–60 VDC ≤ 400 mA 25 Hz Cyclic LED/– Poti	10–60 VDC ≤ 400 mA 25 Hz Cyclic LED/– Poti	10–60 VDC ≤ 400 mA 25 Hz Cyclic LED/– Poti
---	---	---	---	---	---

–25°C/+70°C IP67 Stainless steel 1.4305 3 x 0,5 mm ²	–25°C/+70°C IP67 PBT, black 5 x 0,5 mm ²	–25°C/+70°C IP65 CuZn39Pb3 3 x 0.5 mm ²	–25°C/+70°C IP65 CuZn39Pb3 M12 x 1	–25°C/+70°C IP65 PBT, black 3 x 0.5 mm ²	–25°C/+70°C IP65 PBT, black M12 x 1
--	--	---	---	--	--

You will find detailed data sheets to the products under www.bernstein.eu



Capacitive Sensors (Type M32, Ø 34 mm, E50, E68)

Type	M32	Ø 34 mm		Ø 34 mm	
Type of installation	Non-flush	Flush	Non-flush	Non-flush	Non-flush
Nominal sensing distance	30 mm	20 mm	30 mm	30 mm	30 mm
Type of connection	Cable 2 m	Connector M12	Cable 2 m	Connector M12	Cable 2 m
Special feature	Timer/Relay				

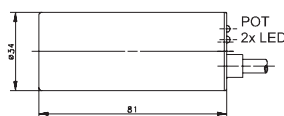
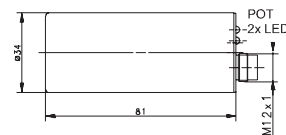
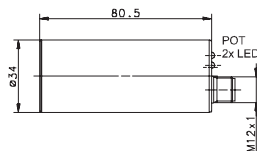
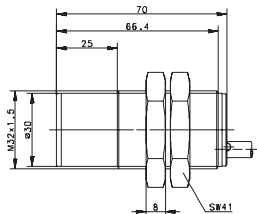

PNP	DC	NO contact Type NC contact Antivalent NO/NC		6507915006 KCB-D34PS/020-KLPS12	6507915001 KCN-R34PS/030-KLP2	6507915004 KCN-R34PS/030-KLPS12	
NPN	DC	NO contact Type NC contact Antivalent NO/NC			6507315001 KCN-R34NS/030-KLP2		
PNP/NPN	DC	NO/NC prog. push-pull operation					
NAMUR	DC						
Analogue	DC						
2-wire	DC	NO contact NC contact					
	AC	NO contact Type NC contact Type Changeover contact Type	6508613001 KCN-T32RU/030-LP2				6508515001 KCN-R34AS/030-LP2 6508415001 KCN-R34AÖ/030-LP2

Technical data

Rated operating voltage	U_B	180–250 V AC	10–60 VDC	10–60 VDC	10–60 VDC	20–250 V AC
Rated operating current	I_e	≤ 8 A	≤ 200 mA	≤ 400 mA	≤ 400 mA	≤ 300 mA
Switching frequency (max)	F	–	25 Hz	25 Hz	25 Hz	15 Hz
Short circuit-protection		–	Cyclic	Cyclic	Cyclic	–
Function/operating voltage indicator		LED/LED	LED/LED	LED/LED	LED/LED	LED/LED
Sensing distance, adjustable		Poti	Poti	Poti	Poti	Poti

Mechanical data

Ambient temperature (min/max)		–25°C/+70°C	–25°C/+70°C	–25°C/+70°C	–25°C/+70°C	–25°C/+70°C
Protection class in accordance with IEC 529, EN 60529		IP65	IP65	IP65	IP65	IP65
Enclosure material		PBT, black	CuZn39Pb3	PBT, red	PBT, red	PBT, red
Connection		5 x 0.5 mm ²	M12 x 1	3 x 0.5 mm ²	M12 x 1	2 x 0.5 mm ²

Please refer to Accessories for cable couplers, mounting brackets and sensor tester.



E50	E68		
Flush 8 mm Cable 2 m	Flush 10 mm Cable 2 m		

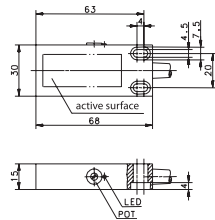
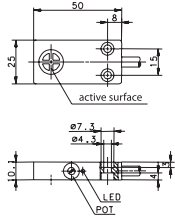

6507990001 KCB-E50PS/008-KLP2	6507956001 KCB-E68PS/010-KLP2				
6507390001 KCB-E50NS/008-KLP2					

10–36 VDC	10–36 VDC		
≤ 200 mA	≤ 200 mA		
25 Hz	25 Hz		
Cyclic	Cyclic		
LED/-	LED/-		
Poti	Poti		

-25°C/+70°C	-25°C/+70°C		
IP65	IP65		
PBT, black	PBT, black		
3 x 0.34 mm ²	3 x 0.5 mm ²		

You will find detailed data sheets to the products under www.bernstein.eu



Magnetic Switches

General Information on BERNSTEIN Magnetic Switches

Electromechanical and electronic variants

BERNSTEIN has extended its range of electromechanical magnetic switches with electronic versions which operate according to the Hall and magnetoresistive principle.

Electromechanical and electronic magnetic switches have special properties which ensure optimum use in their respective environments.

The electronic versions are characterised by their enhanced mechanical properties (extremely high resistance to vibration, shock or impact) and are not prone to wear in operation.

Thanks to the use of only one single “active” component (reed contact), “traditional” electromechanical magnetic switches are extremely reliable in operation. The universal current capability and low procurement costs allow these switches to be used in a wide range of applications.

The matrix below highlights the main features of each functional principle and helps you to decide on which magnetic switch to use for your application.



Technical features and applications

More detailed information on the technical features and applications relating to the different functional principles are provided in the following sections.

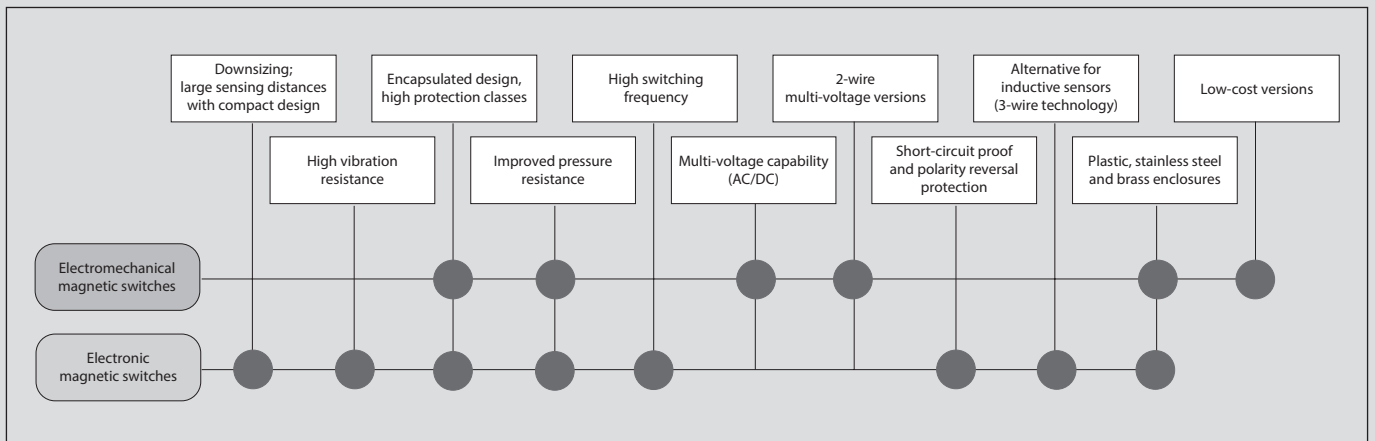

Electromechanical Magnetic Switches

Special features of electromechanical magnetic switches

- Reliable under extreme ambient conditions such as dirt, humidity, gas, dust, etc.
- Protection class up to IP67
- Stable switching point, reproducible switching point accuracy of approx. 0.1 mm
- Can be operated from several directions
- Can be mounted in any position
- High operational reliability ensured by the use of only one single component
- Easy to install
- Long electrical service life (depending on the load to be switched) more than 10^8 switching cycles if contacts are suitably protected
- Special versions available for extreme temperatures from $-40\text{ }^{\circ}\text{C}$ to $+150\text{ }^{\circ}\text{C}$
- Can be connected to direct and alternating voltage sources

Design, function and operating principle of an electromechanical magnetic switch

The basic elements of this type of switch are the components which change their electrical characteristics in response to the approach of an actuating magnet. The contact paddles assume opposing polarity (north and south pole) under the influence of a magnetic field.

The approach can be made by either permanent magnets or electromagnets; the sensitivity of the switch and the field strength of the magnet determine the distance between the switch and magnet. Opening and closing of the contact studs is determined by the magnet correspondingly approaching or moving away from the switch. Normally-closed, normally-open and changeover contacts as well as bistable versions are included in our range of products.

The magnetically influenced parts and their auxiliary components (resistor, diode, triac, output stage, etc.) are cast in high quality insulating material or casting compound to increase the vibration / impact strength and guarantee a protection class up to IP67. Metal versions (stainless steel, aluminium and brass) as well as standard plastic versions are available for use under extreme ambient conditions such as wider temperature ranges.

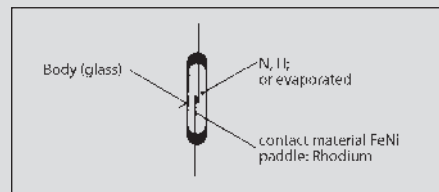

Design of a reed contact

Biasing (bistable)

Bias magnets energise or hold the contact closed. The contact of the bistable normally-open or normally-closed contact is held closed until a stronger magnet with opposite polarity neutralises the biasing.

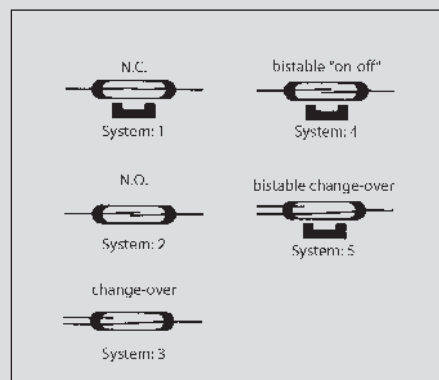

Types of reed contact switches

Actuation and switching characteristics

The switching characteristics are principally determined by the approach and polarity of the magnet. The following drawings show typical characteristics. Materials and external dimensions are specified in the product overview. Magnetic switches with reed contact output are identified by an "A" in the second position of the type code (MA...).

Switching frequency

Up to 200 Hz, depending on the size of load to be switched (considerably faster than relays, contactors etc.).

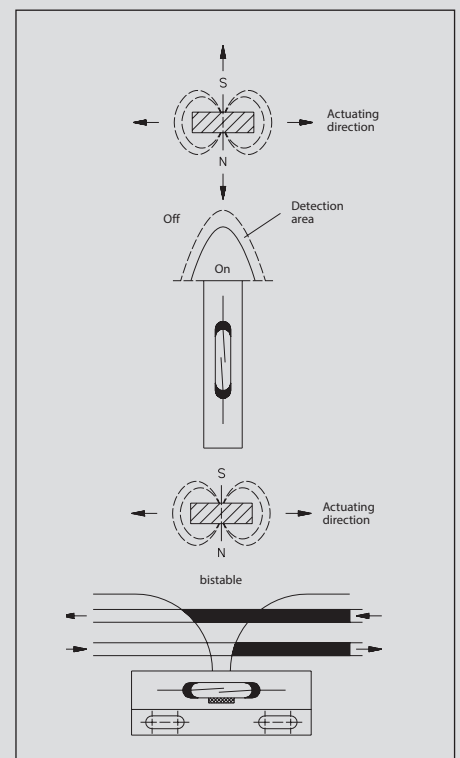
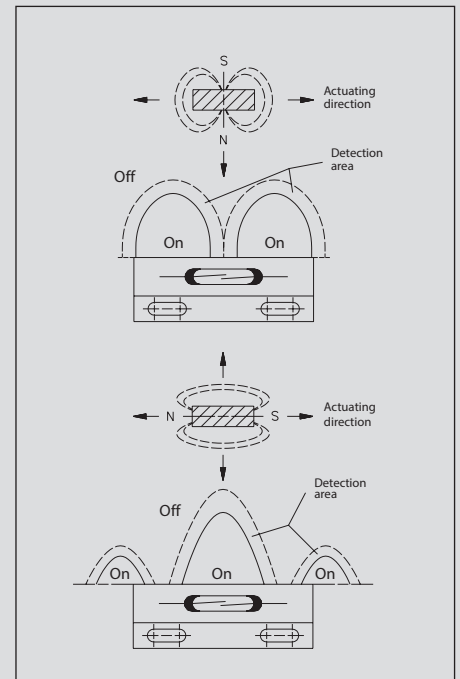

Magnetic Switches

Switching distances

Refer to the tables in this catalogue to identify which switching magnets may be used as well as the minimum achievable switching distance.

Temperature ranges

The standard version may be used in a temperature range from $-5\text{ }^{\circ}\text{C}$ to $+70\text{ }^{\circ}\text{C}$. Special types are also available offering an extended operating temperature range from $-40\text{ }^{\circ}\text{C}$ to $+150\text{ }^{\circ}\text{C}$.

Electrical service life

To maintain a long service life of the electrical contacts, it is important to ensure the maximum supply voltage and maximum switching current are not exceeded. Refer to the diagrams on Page 67 for the load values.

Guidelines for reed contact protection

The values for current, voltage and power specified in the catalogue apply only to purely resistive loads. Very often, however, these loads are exposed to inductive or capacitive components. In these cases it is advisable to protect the reed contacts against voltage and current peaks. Whilst it is not possible to recommend a safe contact protection concept that applies to all load ranges (each individual case will require its own evaluation), we would like to present general guidelines on how reed contacts may be connected to different loads in order to avoid premature failure.

1. Inductive loads

In DC applications, contact protection is relatively easy to realise with the aid of a free-wheeling diode connected in parallel to the load. The diode polarity must be selected so that it blocks when normal operating voltage is applied but will short-circuit the voltage induced after the switch is opened (voltage peaks can significantly exceed the operating voltage).

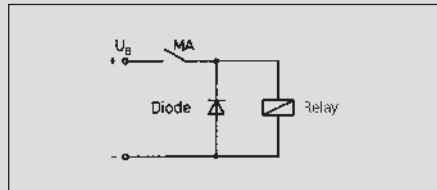

Suppression of voltage peaks with a free-wheeling diode

1) Voltage peaks induced by switching off inductive loads are suppressed by connecting a voltage-dependent resistor (VDR) in parallel to the reed contact.

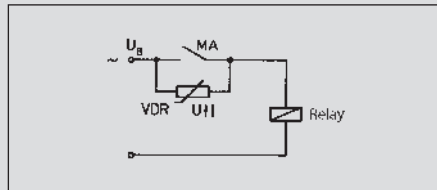

Suppression of voltage peaks with a VDR

2) In AC voltage applications effective protection is achieved with a combination of a resistor and a capacitor (RC element).

Generally, the RC element is connected parallel to the contact and therefore in series to the load (vice versa is also possible).

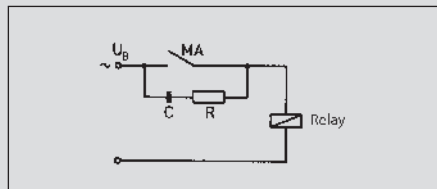

Suppression of voltage peaks with RC element

2. Capacitive loads

In contrast to inductive loads, an increase of making currents can occur in connection with capacitive loads and lamp loads that could damage and even weld contacts closed. When capacitors are switched (e.g. cable capacitance) a very high peak current occurs with its intensity depending on the capacitance and length of the cable leading to the switch.

A resistor connected in series to the contact will reduce this current. The size of the resistor is determined by the characteristics of the corresponding electric circuit.

It should, however, be as large as possible to reduce the current to a permissible value, thus ensuring reliable contact protection.

Contact protection with resistors for limiting current:

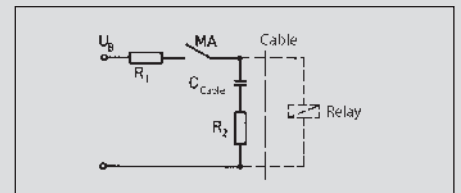

Capacitive load

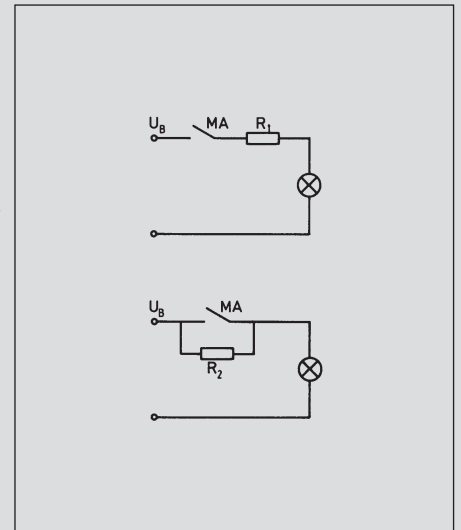

Lamp load

Performance diagrams for electromechanical magnetic switches

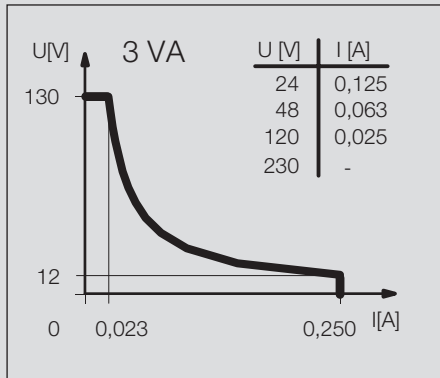

(1)

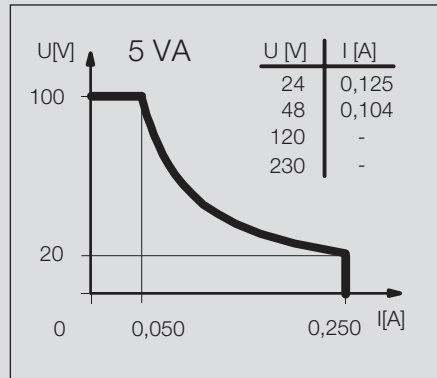

(2)

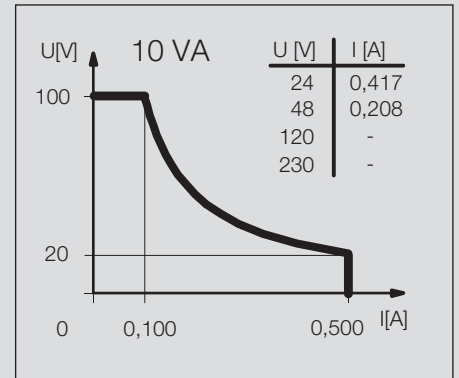

(3)

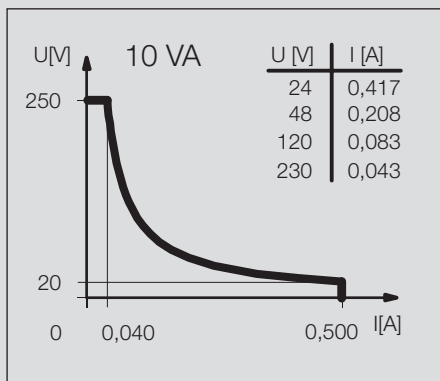

(4)

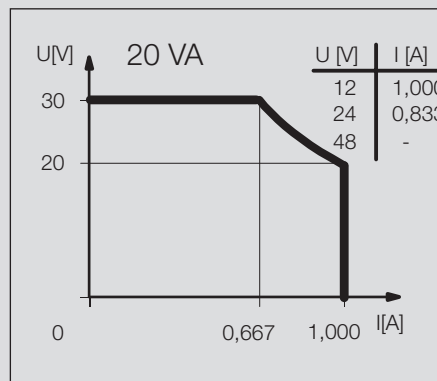

(5)

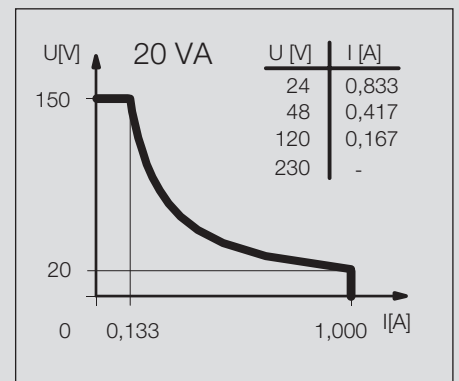

(6)

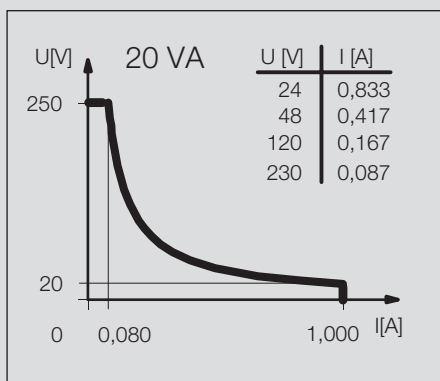

(7)

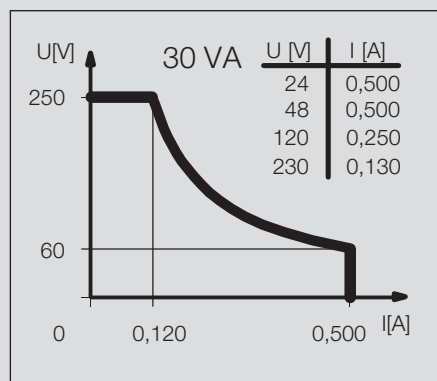

(8)

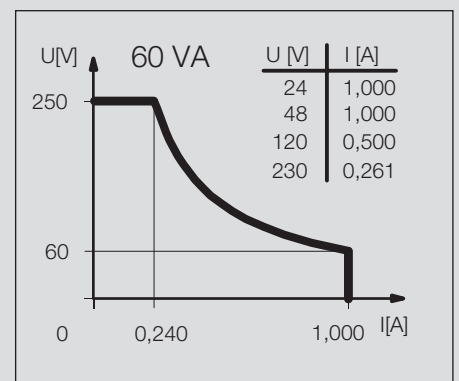

(9)

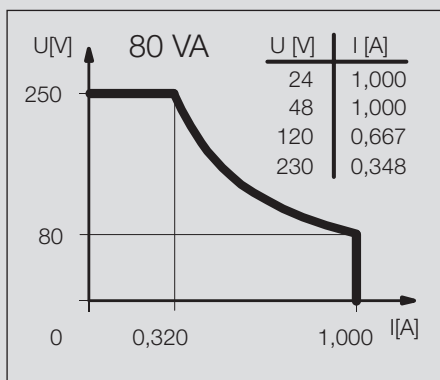

(10)

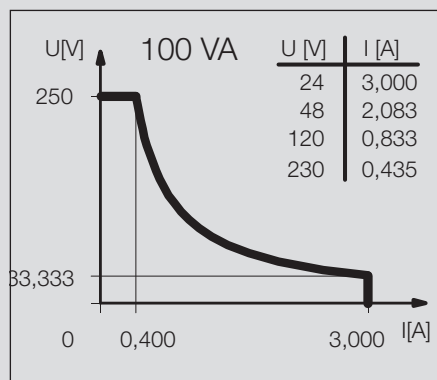

(11)

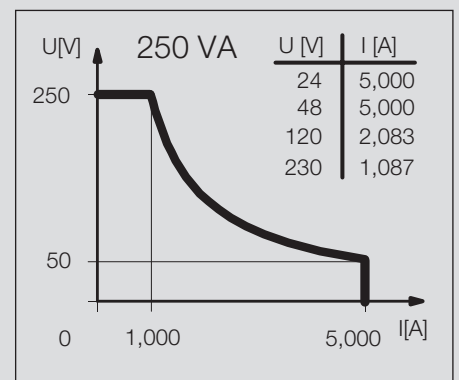

(12)

Magnetic Switches (Type Ø 6 mm, Ø 6.5 mm, Ø 12 mm, Ø 13 mm)

Type	Ø 6 mm		Ø 6.5 mm		Ø 12 mm	
Nominal switching distance (San)	19 mm	19 mm	18 mm		6 mm	7 mm
Type of connection	Cable 1 m	Cable 1 m	Cable 2 m		Cable 1 m	Cable 1 m
Reference magnet (Page)	T-62 N/S	T-62 N/S	T-62 N/S		T-62 N/S	T-62 N/S
Special feature						

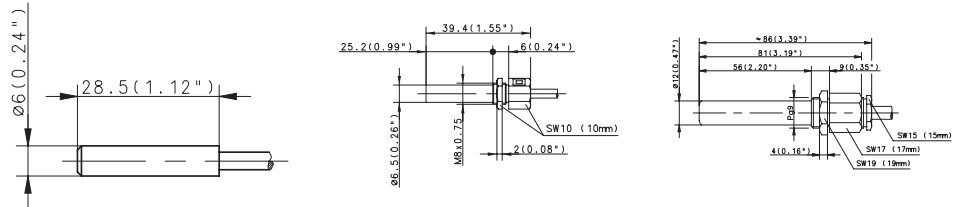

Switching function	NO contact	6311230571	6310246500		6314206246
	Type	MAK-3012-B-1	MAK-4612-A-2		MAA-0612-F-1
NC contact	Type				
	Changeover contact	6310330572		6317306315	
Type		MAK-3013-X-1		MAA-0613-M-1	
	Bistable				
Type					

Technical data	Ø 6 mm		Ø 6.5 mm		Ø 12 mm	
Max. switching voltage	100 V	250 V	250 V		250 V	250 V
Switching current (max)	0.25 A	0.5 A	0.5 A		1 A	3 A
Performance class (diagram No.)	5 VA	10 VA	20 VA		80 VA	100 VA
Shock resistance		50 g (11 ms)				

Mechanical data	Ø 6 mm		Ø 6.5 mm		Ø 12 mm	
Ambient temperature (min/max)	-5°C/+70°C	-5°C/+70°C	-5°C/+70°C		-5°C/+70°C	-5°C/+70°C
Protection class in accordance with IEC 529, EN 60529	IP67	IP67	IP67		IP67	IP67
Enclosure material	PA	PA	PA		Aluminium	Al/CuZn39Pb3
Connection	3 x 0.14 mm ²	2 x 0.14 mm	2 x 0.14 mm ²		4 x 0.75 mm ²	3 x 0.75 mm ²

Please refer to Accessories for magnets, mounting brackets, cable couplers and sensor tester.

Type	Ø 12 mm		Ø 12 mm		Ø 12 mm	
Nominal switching distance (San)	7 mm	7 mm	7 mm	7 mm	8 mm	12 mm
Type of connection	Cable 1 m	Cable 3 m	Cable 8 m	Cable 2 m	Cable 1 m	Cable 1 m
Reference magnet (Page)	T-62 N/S	T-62 N/S	T-62 N/S	T-62 N/S	T-62 N/S	T-62 N/S
Special feature			Temperature			

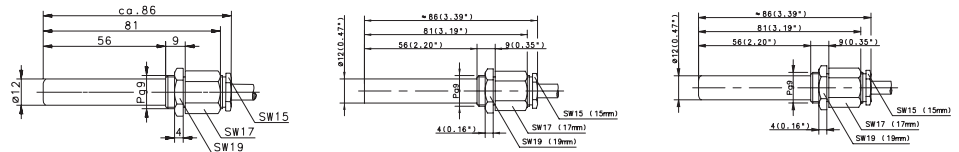

Switching function	NO contact	6312206321	6314216476	6314216585	6314226423	
	Type	MAA-0612-D-1	MAN-1612-F-3	MAN-1612-FT-8	MAK-2612-F-1	
NC contact	Type					
	Changeover contact					6315306314
Type						MAA-0613-K-1
	Bistable					6316316259
						MAN-1613-L-1

Technical data	Ø 12 mm		Ø 12 mm		Ø 12 mm	
Max. switching voltage	250 V	250 V	250 V	250 V	250 V	250 V
Switching current (max)	0.5 A	3 A	3 A	3 A	0.5 A	1 A
Performance class (diagram No.)	30 VA	100 VA	100 VA	100 VA	30 VA	60 VA
Shock resistance		50 g (11 ms)				

Mechanical data	Ø 12 mm		Ø 12 mm		Ø 12 mm	
Ambient temperature (min/max)	-5°C/+70°C	-5°C/+70°C	-40°C/+150°C	-5°C/+70°C	-5°C/+70°C	-5°C/+70°C
Protection class in accordance with IEC 529, EN 60529	IP67	IP67	IP67	IP67	IP67	IP67
Enclosure material	Aluminium	Stainless steel 1.4305	Stainless steel 1.4305	PA, red	Al/CuZn39Pb3	Stainless steel 1.4305
Connection	3 x 0.75 mm ²	3 x 0.75 mm ²	3 x 0.75 mm ²	2 x 0.5 mm ²	4 x 0.75 mm ²	4 x 0.75 mm ²

Please refer to Accessories for magnets, mounting brackets, cable couplers and sensor tester.

Ø 12 mm		Ø 12 mm		Ø 12 mm		Ø 13 mm	
12 mm	12 mm	16 mm	18 mm	19 mm	19 mm	9 mm	20 mm
Cable 1 m	Cable 1 m	Cable 4 m	Cable 1m	Cable 1 m	Cable 1 m	Cable 1 m	Cable 1 m
T-62 N/S	T-62 N/S	T-62 N/S	T-62 N/S	T-69 N/S	T-69 N/S	T-62 N/S	T-62 N/S
		Temperature			Temperature		

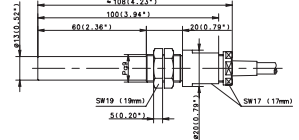
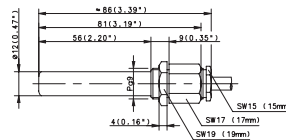
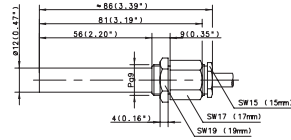
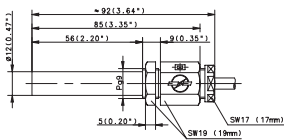

6316326426 MAK-2613-L-1	6315326425 MAK-2613-K-1	6410206399 MAA-0612-NT-4	6310406554 MAA-0614-P-1	6316306248 MAA-0613-L-1	6316306004 MAA-0613-LT-1	6310136616 MAK-3611-P-1	6310536617 MAK-3615-L-1
-----------------------------------	-----------------------------------	------------------------------------	-----------------------------------	-----------------------------------	------------------------------------	-----------------------------------	-----------------------------------

250 V	250 V	250 V	250 V	250 V	250 V	250 V	250 V
1 A	0.5 A	1.5 A	5 A	1 A	1 A	5 A	1 A
60 VA	30 VA	50 VA	250 VA	60 VA	60 VA	250 VA	60 VA

-5°C/+70°C	-5°C/+70°C	-40°C/+150°C	-5°C/+70°C	-5°C/+70°C	-40°C/+150°C	-5°C/+70°C	-5°C/+70°C
IP67	IP67	IP67	IP67	IP67	IP67	IP67	IP67
PA, red	PA, red	Al/CuZn39Pb3	Al/CuZn39Pb3	Al/CuZn39Pb3	Al/CuZn39Pb3	PA, black	PA, black
3 x 0.5 mm ²	3 x 0.5 mm ²	3 x 0.75 mm ²	3 x 0.5 mm ²	4 x 0.75 mm ²	4 x 0.75 mm ²	2 x 0.75 mm ²	3 x 0.75 mm ²

You will find detailed data sheets to the products under www.bernstein.eu



Magnetic Switches (Type Ø 15.5 mm, M8, M12, PG9, 28.6 x 18 mm)

Type	Ø 15.5 mm	M8	M8	M8
Nominal switching distance (San)	6 mm	13 mm	13 mm	18 mm
Type of connection	Connector	Cable 1 m	Connector	Cable 1 m
Reference magnet (Page)	T-62 N/S	T-62 N/S	T-62 N/S	T-62 N/S
Special feature				

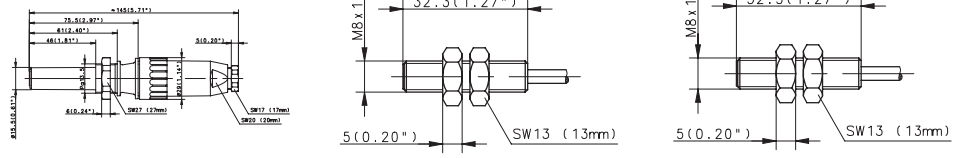

Switching function	NO contact				6311208596
	Type				MAN-0812-B-1
	NC contact				
	Type				
Changeover contact	Type	6317304313	6310308597	6310308595	
	Type	MAK-0413-M-S	MAN-0813-Y-1	MAN-0813-STK	
	Bistable				
	Type				

Technical data					
Max. switching voltage	250 V	100 V	30 V	250 V	
Switching current (max)	1 A	0.5 A	1 A	0.5 A	
Performance class (diagram No.)	80 VA	10 VA	20 VA	10 VA	
Shock resistance					

Mechanical data					
Ambient temperature (min/max)	-5°C/+70°C	-20°C/+70°C	-5°C/+70°C	-5°C/+70°C	
Protection class in accordance with IEC 529, EN 60529	IP65	IP67	IP65	IP67	
Enclosure material	PC, grey	Stainless steel 1.4305	Stainless steel 1.4305	Stainless steel 1.4305	
Connection	Amphenol	3 x 0.14 mm ²	Ø 6.5 mm	2 x 0.14 mm ²	

Please refer to Accessories for magnets, mounting brackets, cable couplers and sensor tester.

Type	M12	M12	M12	M12
Nominal switching distance (San)	7 mm	7 mm	10 mm	12 mm
Type of connection	Cable 1 m	Cable 2 m	Cable 1 m	Cable 1 m
Reference magnet (Page)	T-62 N/S	T-62 N/S	T-62 N/S	T-62 N/S
Special feature				

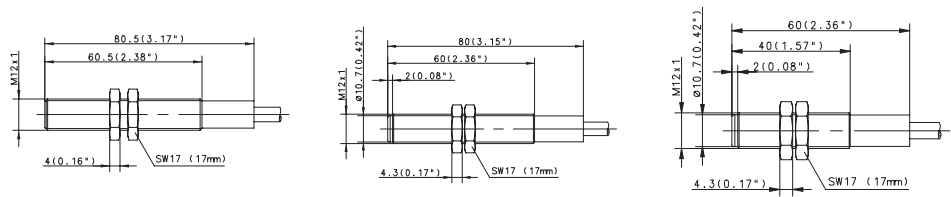

Switching function	NO contact	6314223268	6314233002		6416228260	6311218294
	Type	MAM-2312-F-1	MAK-3312-F-2		MAK-2812-L-3	MAM-1812-B-1
	NC contact					
	Type					
Changeover contact	Type			6316333005	6316318002	
	Type			MAK-3313-L-1	MAM-1813-L-1	
	Bistable					
	Type					

Technical data					
Max. switching voltage	250 V	250 V	250 V	250 V	250 V
Switching current (max)	3 A	3 A	1 A	1 A	0.5 A
Performance class (diagram No.)	100 VA	100 VA	60 VA	60 VA	10 VA
Shock resistance		50 g (11 ms)			50 g (11 ms)

Mechanical data					
Ambient temperature (min/max)	-5°C/+70°C	-25°C/+70°C	-5°C/+70°C	-5°C/+70°C	-5°C/+70°C
Protection class in accordance with IEC 529, EN 60529	IP67	IP67	IP67	IP67	IP67
Enclosure material	CuZn39Pb3	PA, red	PA, red	CuZn39Pb3	PA, red
Connection	2 x 0.5 mm ²	2 x 0.5 mm ²	3 x 0.5 mm ²	3 x 0.5 mm ²	2 x 0.34 mm ²

Please refer to Accessories for magnets, mounting brackets, cable couplers and sensor tester.

M12		PG9		PG9		28.6x18x6.4mm	
18 mm	22 mm	17 mm	20 mm	20 mm	8 mm	8 mm	
Cable 2 m	Cable 2 m	Cable 2 m	Cable 2 m	Cable 2 m	Cable 1 m	Cable 1.5 m	
T-62 N/S	T-62 N/S	T-62 N/S	T-62 N/S	D	TK-11-11	TK-11-11	

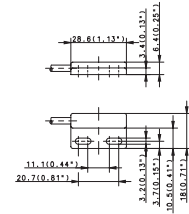
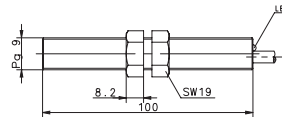
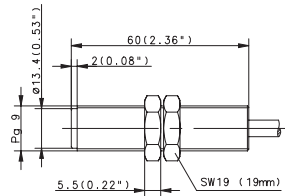
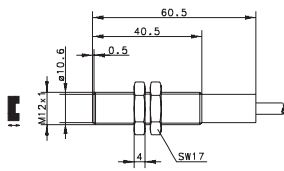

6310118626 MAM-1811-2	6410433350 MAK-3314-P-2	6316343544 MAM-4313-L-2	6310431569 MAM-3114-2-LED	6310311615 MAK-1113-1	6410311368 MAK-1113-1,5
---------------------------------	-----------------------------------	-----------------------------------	-------------------------------------	---------------------------------	-----------------------------------

175 V	250 V	250 V	250 V	130 V	130 V
0.25 A	1.5 A	1 A	1 A	0.25 A	0.25 A
5 VA	250 VA	60 VA	120 VA	3 VA	3 VA
50 g (11 ms)					

-5°C/+70°C	-25°C/+70°C	-5°C/+80°C	-5°C/+80°C	-5°C/+70°C	-20°C/+70°C
IP67	IP67	IP65	IP65	IP67	IP67
CuZn39Pb3	PA, red	CuZn39Pb3	CuZn39Pb3	PA, black	PA
2 x 0.34 mm ²	2 x 0.5 mm ²	3 x 0.5 mm ²	2 x 0.5 mm ²	3 x 0.14 mm ²	3 x 0.14 mm ²

You will find detailed data sheets to the products under www.bernstein.eu



Magnetic Switches (Type 28.6 x 18, 45 x 13, 45 x 25.5, 68 x 30, 80 x 20)

Type	28.6x18x6.4mm		45x13x9mm		45x25.5x9mm	
Nominal switching distance (San)	10 mm	25 mm	10 mm		5 mm	10 mm
Type of connection	Cable 1 m	Cable 5 m	Cable 2 m		Cable 1 m	Cable 1 m
Reference magnet (Page)	TK-11-11	T-67 N/S	TK-11-01		TK-45	TK-45
Special feature						

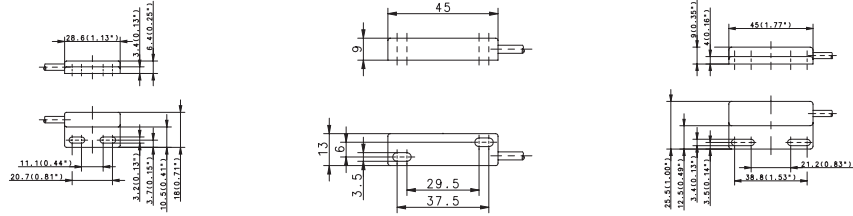

Switching function	NO contact	6311211541	6311201095		6311245539
	Type	MAK-1112-B-1	MAK-0112-B-2		MAK-4512-B-1
NC contact	Type				
	Changeover contact				
Type					
	Bistable	6311411603		6316345540	
Type		MAK-1114-B-5		MAK-4513-L-1	

Technical data	28.6x18x6.4mm		45x13x9mm		45x25.5x9mm	
Max. switching voltage	250 V	250 V	250 V		250 V	250 V
Switching current (max)	0.5 A	0.5 A	0.5 A		1 A	0.5 A
Performance class (diagram No.)	10 VA	10 VA	10 VA		60 VA	10 VA
Shock resistance						50 g (11 ms)

Mechanical data	28.6x18x6.4mm		45x13x9mm		45x25.5x9mm	
Ambient temperature (min/max)	-5°C/+70°C		-5°C/+70°C		-5°C/+70°C	
Protection class in accordance with IEC 529, EN 60529	IP67		IP67		IP67	
Enclosure material	PA, black		PA, black		PA	
Connection	2 x 0.14 mm		2 x 0.14 mm		2 x 0.34 mm ²	

Please refer to Accessories for magnets, mounting brackets, cable couplers and sensor tester.

Type	68x30x15mm		80x20x15mm		80x20x15mm	
Nominal switching distance (San)	8 mm		18 mm	18 mm	20 mm	10 mm
Type of connection	Cable 1 m		Cable 1 m	Cable 1 m	Cable 3 m	Cable 3 m
Reference magnet (Page)	T-62 N/S		TK-21-02	TK-21-02	T-62 N/S	T-67
Special feature					Temperature	

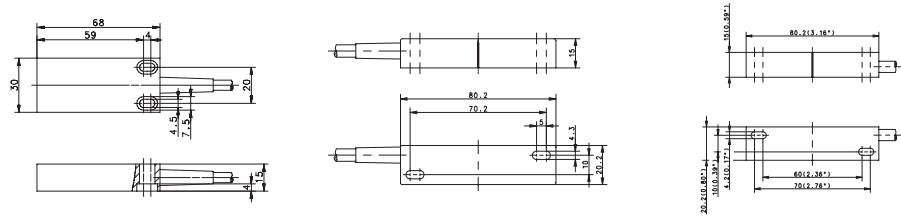

Switching function	NO contact	6316313004	6315302309	6315312196	6314402566	6419402397
	Type	MAK-1313-L-1	MAK-0213-K-1	MAK-1213-K-1	MAA-0214-FT-3	MAK-0214-P-3
NC contact	Type					
	Changeover contact					
Type						
	Bistable					

Technical data	68x30x15mm		80x20x15mm		80x20x15mm	
Max. switching voltage	250 V		250 V	250 V	250 V	250 V
Switching current (max)	1 A		0.5 A	0.5 A	3 A	5 A
Performance class (diagram No.)	60 VA		30 VA	30 VA	100 VA	250 VA
Shock resistance						10 g (11 ms)

Mechanical data	68x30x15mm		80x20x15mm		80x20x15mm	
Ambient temperature (min/max)	-5°C/+70°C		-5°C/+70°C	-5°C/+70°C	-40°C/+150°C	-25°C/+70°C
Protection class in accordance with IEC 529, EN 60529	IP67		IP67	IP67	IP67	IP67
Enclosure material	PC, red		PA, black	PA, red	GDAISI12, red	PA, black
Connection	3 x 0.5 mm ²		3 x 0.75 mm ²	3 x 0.75 mm ²	3 x 0.75 mm ²	2 x 0.5 mm ²

Please refer to Accessories for magnets, mounting brackets, cable couplers and sensor tester.

80x20x15 mm		80x20x15 mm		80x20x15 mm	
21 mm	21 mm	21 mm	24 mm	24 mm	25 mm
Cable 1 m	Cable 1 m	Cable 1 m	Cable 1 m	Cable 1 m	Cable 1 m
TK-21-02	TK-21-02	TK-21-12	TA-21-02	TK-21-12	T-62 N/S

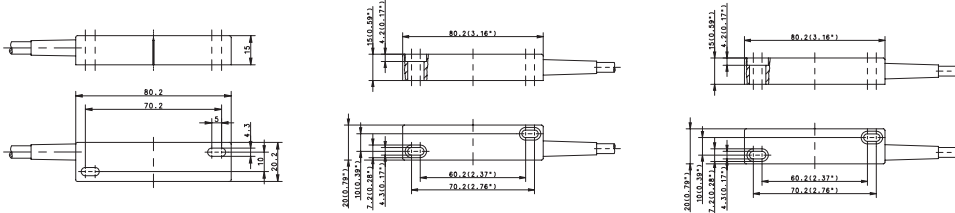

6312202316 MAK-0212-L-1	6314202204 MAK-0212-F-1	6314212217 MAK-1212-F-1	6316302206 MAK-0213-L-1	6316312220 MAK-1213-L-1	6410412143 MAK-1214-L-2
-----------------------------------	-----------------------------------	-----------------------------------	-----------------------------------	-----------------------------------	-----------------------------------

250 V	250 V	250 V	250 V	250 V	250 V
0.5 A	3 A	3 A	1 A	1 A	1 A
30 VA	100 VA	100 VA	60 VA	60 VA	60 VA

-5°C/+70°C	-5°C/+70°C	-5°C/+70°C	-5°C/+70°C	-5°C/+70°C	-5°C/+70°C
IP67	IP67	IP67	IP67	IP67	IP67
PA, black	PA, black	PA, red	PA, black	PA, red	PA, red
2 x 0.75 mm ²	2 x 0.75 mm ²	2 x 0.5 mm ²	3 x 0.5 mm ²	3 x 0.5 mm ²	2 x 0.5 mm ²

You will find detailed data sheets to the products under www.bernstein.eu



Magnetic Switches (Type 80 x 20 mm, 80 x 30 mm, 85 x 24 mm, 88 x 25 mm, 100 x 58 mm)

Type	80x20x15 mm		80x30x15 mm		80x30x15 mm	
Nominal switching distance (San)	25 mm	30 mm	8 mm	19 mm	20 mm	22 mm
Type of connection	Connector M8	Cable 1 m	Cable 1 m	Cable 1 m	Cable 1 m	Cable 1 m
Reference magnet (Page)	Ø 10 x 50 Neod	TA-21-02	TK-44	TK-44	T-62 N/S	TK-44
Special feature		Temperature				

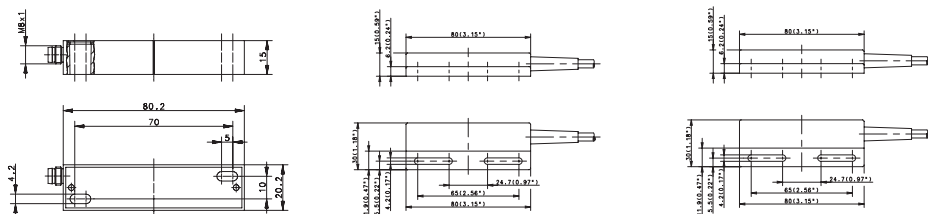

Switching function	80x20x15 mm		80x30x15 mm		80x30x15 mm	
	NO contact Type				6314244536 MAK-4412-F-1	
NC contact Type			6314144542 MAK-4411-F-1			
Changeover contact Type	6310302636 MAA-0213-STK	6316302389 MAA-0213-LT-1			6317344538 MAK-4413-M-1	
Bistable Type					6310444537 MAK-4414-P-1	

Technical data	80x20x15 mm		80x30x15 mm		80x30x15 mm	
Max. switching voltage	60 V	250 V	250 V	250 V	250 V	250 V
Switching current (max)	1 A	1 A	3 A	3 A	5 A	1 A
Performance class (diagram No.)	3 VA	60 VA	100 VA	100 VA	250 VA	80 VA
Shock resistance		10 g (11 ms)				

Mechanical data	80x20x15 mm		80x30x15 mm		80x30x15 mm	
Ambient temperature (min/max)	-30°C/+80°C	-40°C/+150°C	-5°C/+70°C	-5°C/+70°C	-5°C/+70°C	-5°C/+70°C
Protection class in accordance with IEC 529, EN 60529	IP65	IP67	IP67	IP67	IP67	IP67
Enclosure material	GDAISi 12, red	GDAISi12, red	PA, black	PA, black	PA, black	PA
Connection	M8 x 1	4 x 0.75 mm ²	2 x 0.5 mm ²	2 x 0.5 mm ²	2 x 0.5 mm ²	3 x 0.5 mm ²

Please refer to Accessories for magnets, mounting brackets, cable couplers and sensor tester.

Type	85x24x26 mm		85x24x26 mm		88x25x13 mm	
Nominal switching distance (San)	15 mm	24 mm	24 mm		22 mm	25 mm
Type of connection	Cable 3 m	Cable 1 m	Flat plug		Cable 1 m	Cable 1 m
Reference magnet (Page)	T-67 N/S	T-69 N/S	T-69 N/S		TK-42	TK-42
Special feature			K4.8			

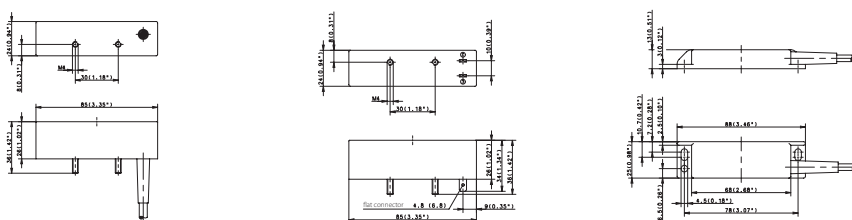

Switching function	85x24x26 mm		85x24x26 mm		88x25x13 mm	
	NO contact Type					6314242533 MAK-4212-F-1
NC contact Type						
Changeover contact Type					6317342535 MAK-4213-M-1	
Bistable Type	6314432609 MAK-3214-F-3	6310432598 MAK-3214-P-1	6310432590 MAK-3214-P-STK4.8			

Technical data	85x24x26 mm		85x24x26 mm		88x25x13 mm	
Max. switching voltage	250 V	250 V	250 V		250 V	250 V
Switching current (max)	3 A	5 A	5 A		1 A	3 A
Performance class (diagram No.)	100 VA	250 VA	250 VA		80 VA	100 VA
Shock resistance						

Mechanical data	85x24x26 mm		85x24x26 mm		88x25x13 mm	
Ambient temperature (min/max)	-25°C/+70°C	-5°C/+70°C	-20°C/+70°C		-5°C/+70°C	-5°C/+70°C
Protection class in accordance with IEC 529, EN 60529	IP67	IP67	IP67		IP67	IP67
Enclosure material	PBT	PA, black	PBT, black		PA, black	PA, black
Connection	2 x 0.5 mm ²	2 x 0.75 mm ²	4.8 mm		3 x 0.5 mm ²	2 x 0.5 mm ²

Please refer to Accessories for magnets, mounting brackets, cable couplers and sensor tester.

88x25x13 mm		100x58x29.5		100x58x29.5	
25 mm	25 mm	10 mm	10 mm	15 mm	
Cable 1 m	Cable 3 m	Screw terminal	Screw terminal	Screw terminal	
T-69 N/S	T-69 N/S	TA-31	TA-31	T-62 N/S	

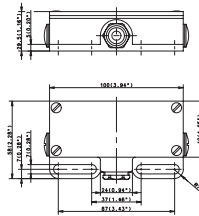
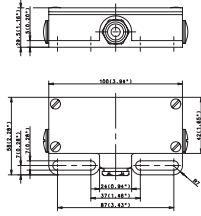
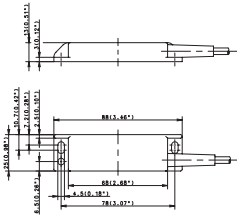

			6314203232 MAA-0312-F		
6310442534 MAK-4214-P-1	6310442622 MAK-4214-P-3	6317303312 MAA-0313-M		6319403532 MAA-0314-P	

250 V	250 V	250 V	250 V	250 V
5 A	5 A	1 A	3 A	5 A
250 VA	250 VA	80 VA	100 VA	250 VA

-5°C/+70°C	-5°C/+70°C	-5°C/+70°C	-25°C/+70°C	-25°C/+70°C
IP67	IP67	IP67	IP65	IP65
PA, black	PA, black	Aluminium	Aluminium	Aluminium
2 x 0.5 mm ²	2 x 0.5 mm ²	max. 1.5 mm ²	max. 1.5 mm ²	max. 1.5 mm ²

You will find detailed data sheets to the products under www.bernstein.eu



Electronic Magnetic Sensors

Thanks to their special properties, electronic magnetic switches with magnetoresistive or Hall elements are ideal for use in many different applications. They are used to detect position, angle and / or speed and are immune to shock, impact, vibration and wear. High switching frequencies, long switching distances, a broad temperature range and excellent reproducibility are other advantageous features of this technology which in many cases make them the technically superior alternative to electromechanical reed contacts.

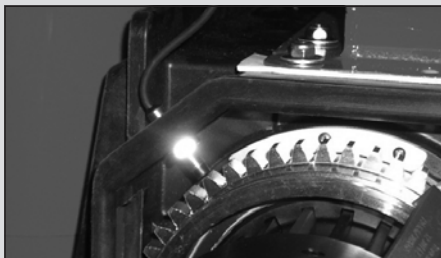

The fact that many non-magnetic metals allow magnetic fields to pass unhindered also extends the fields of application for magnetic sensors. This makes it possible to encapsulate sensors in a sturdy pressure-proof metal enclosure. Sensors can, however, also be mounted in tubing or concealed behind non-magnetic metal surfaces.

Advantages of electronic magnetic sensors over electromechanical reed contacts

- Reliable and immune to vibration
- Bounce-free switching
- Unlimited service life
- High repeat accuracy
- Short response times
- High sensitivity
- Thermal stability

Select the sensor and the technical principle that best meet your requirements from the comprehensive BERNSTEIN range of magnetic sensors: Hall sensors with minimum circuitry, standard Hall sensors with integrated sensor electronics or magnetoresistive sensors. Round, square or metric bodies in plastic, brass, brass / plastic or stainless enclosures.

Fundamentals of Hall sensor technology

The BERNSTEIN range of magnetic sensors is based on a modular system comprising an encapsulated Hall element with the EMC protective circuitry. These sensors therefore conform to the requirements of EN-60947-5-2 for non-mechanical magnetic proximity switches. Sensors of various designs are available for a wide variety of applications.



- Output circuitry NPN, NO contact or bistable
- Voltage range 4.5 – 24 V DC
- Polarity reversal protected
- Switching frequencies up to 20 kHz
- Size ranging from 6 mm diameter to 50 x 25 x 10 mm
- Unipolar version

Standard range of Hall sensors

In contrast to the more basic BERNSTEIN Hall sensors, the functionality and modularity have been enhanced in these Hall sensors by integrating comprehensive sensor electronics. In this segment BERNSTEIN also offers a complete modular system that can be adapted to suit your specific needs.

- Output circuitry PNP, NC or NO contact or bistable
- Voltage range 10 – 39 V DC
- Output current 400 mA, short-circuit proof
- Polarity reversal protected
- Switching frequencies up to 10 kHz
- Size ranging from M10 diameter to 50 x 25 x 10 mm
- Unipolar version

Single-channel speed sensors with high frequency range

BERNSTEIN offers a high performance series of gearwheel sensors designed as electronic magnetic sensors with Hall elements that detect the rotation of near-engine ferromagnetic gearwheels with sensing distances of up to 2 mm. A specific feature of these single-channel speed sensors is their high switching frequency. Based on the BERNSTEIN modular range of magnetic sensors, switching frequencies of up to 20 kHz can be realised. Switching frequencies up to 10 kHz can be achieved in the standard range. The sensors are available in M12 and M18 versions. The characteristic versatility of Hall sensors is fully utilised in these applications:

Outstanding immunity to shock, impact, vibration, non-wearing and silent, high switching frequencies, broad temperature range, exceptional repeat accuracy.

Technical data

- Output circuitry PNP or NPN
- Voltage range 10 – 36 V DC
- Switching frequencies up to 20 kHz
- Sensing distance 0 – 2 mm on ferromagnetic material

Standard range of magnetoresistive sensors

Magnetoresistive sensors are more sensitive than Hall-effect sensors by a factor of 10. Not only can they be very small but they can also detect especially low field strengths.

In addition to their high measuring accuracy even at high ambient temperatures, these sensors are also characterised by a high degree of reliability and by the fact that they occupy little space. Since they are designed to be independent of polarity, the countermagnet does not need to be mounted with pole orientation. With corresponding encapsulation, BERNSTEIN magnetoresistive sensors have proven effective even in demanding environments such as lift construction or agricultural technology.

- Output circuitry PNP, NC or NO contact
- High sensitivity (up to sensing distance of 60 mm)
- Voltage range 10 – 39 V DC/10 – 30 V DC
- Output current 400 mA/200 mA, short-circuit proof
- Polarity reversal protected
- Polarity independent
- Size 6 mm diameter to M18

Microsensors

Ever more complex and above all more compact measuring and control configurations require components that occupy even less space. In line with this trend, BERNSTEIN has expanded its comprehensive range of sensors for determining position, angle and / or speed in industrial applications in two branches of development: Compared to the previous smallest model (RD = 6 mm), the diameter in this series of magnetoresistive sensors has been further reduced by 30 % yet the smallest model RD = 4 mm or 5 x 5 mm still achieves the parameters of the larger sensors. As part of the second development stage, the basic and standard range of electronic magnetic sensors has been expanded to include the latch functionality (bistable switching characteristic) which utilises the magnetic field only for the corresponding switching operation. As a result, this functionality has been added to a wide range of enclosure variants in the current modular range.

Sensing distances of electronic magnetic sensors

Since the sensing distances of magnetic sensors are influenced by the combination of sensor and magnet, it is appropriate to consider them as a complete system. The overview below shows the expected sensing distances (Sn) when using different magnets from the BERNSTEIN range.

Magnet	Size	Article number	Sn of Hall sensors	Sn of magneto-resistive sensors
T 75	Ø 5 mm	6301175057	5 mm	10 mm
T 06	Ø 6 mm	6301106065	5 mm	15 mm
T 61	Ø 20 mm	6301261035	10 mm	35 mm
T 62	Ø 23 mm	6301262039	17 mm	45 mm
T 67	Ø 20 mm	6301167054	15 mm	40 mm
T 69	Ø 31 mm	6301269031	20 mm	60 mm

Electronic Magnetic Sensors (Type D04, D06, M05, M08, M10, M12)

Type	D04	D06		M05
Operating mode	MR	Hall	MR	MR
Magnetic sensitivity (mT)	3 mT	10 mT	2 mT	3 mT
Sensing distance (S _n)	30 mm	17 mm	45 mm	30 mm
Reference magnet (Page)	T-62 N/S	T-62 N/S	T-62 N/S	T-62 N/S
Type of connection	Cable 2 m	Cable 2 m	Cable 2 m	Cable 2 m
Special feature				

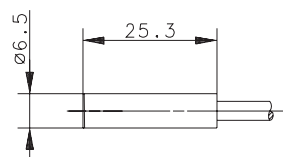
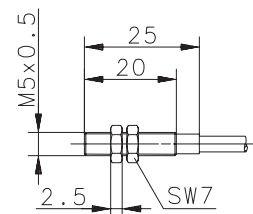
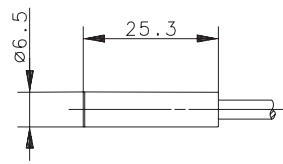
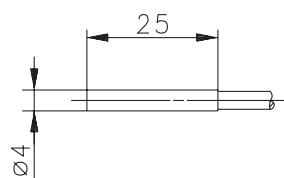

PNP	NO contact Type NC contact Type Bistable Type	6373299132	MEN-D04PS/M03-K2	6373270105	MEN-D06PS/M02-K2	6373299133	MEM-M05PS/M03-K2
NPN	NO contact Type NC contact Bistable Type			6362670001 MEN-D06NS/H10-K2 6363870032 MEN-D06NB/H11-K2			
Analogue	Current output Voltage output						

Technical data

Rated operating voltage	U _B	4.5–30 VDC	4.5–24 VDC	10–30 VDC	4.5–30 VDC
Rated operating current	I _e	200 mA	25 mA	200 mA	200 mA
Max. switching voltage	F	10 kHz	20 kHz	1500 Hz	10 kHz
Function/operating voltage indicator		–/–	–/–	–/–	–/–
Sensitivity adjustable					
Short circuit-protection		Current limiter	Current limiter	Cyclic	Current limiter
Teachable					

Mechanical data

Ambient temperature (min/max)		–20°C/+70°C	–25°C/+70°C	–25°C/+70°C	–20°C/+70°C
Protection class in accordance with IEC 529, EN 60529		IP67	IP67	IP67	IP67
Enclosure material		Stainless steel 1.4401	Stainless steel 1.4401	Stainless steel 1.4401	CuZn39Pb3
Connection		3 x 0.14 mm ²	3 x 0.14 mm ²	3 x 0.14 mm ²	3 x 0.14 mm ²

Please refer to Accessories for magnets, mounting brackets, cable couplers and sensor tester.



M08		M10		M10		M12	
Hall	MR	Hall	Hall	MR		Hall	Hall
10 mT	2 mT	10 mT	10 mT	1 mT		10 mT	10 mT
17 mm	45 mm	17 mm	17 mm	45 mm		17 mm	17 mm
T-62 N/S	T-62 N/S	T-62 N/S	T-62 N/S	T-62 N/S		T-62 N/S	T-62 N/S
Cable 2 m	Cable 2 m	Cable 2 m	Cable 2 m	Cable 2 m		Cable 2 m	Cable 2 m
			All-metal	All-metal			

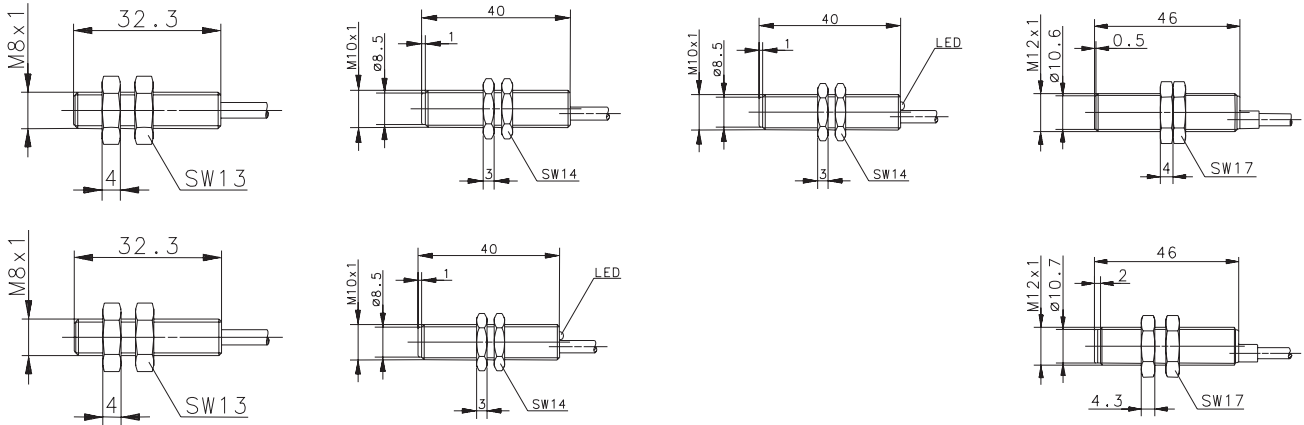

	6373260107 MEM-M08PS/M02-K2		6372261085 MEM-M10PS/H10-KL2 6372161086 MEM-M10PÖ/H10-KL2 6373461124 MEM-M10PB/H11-KL2	6373261087 MEM-M10PS/M01-KL2 6373161088 MEM-M10PÖ/M01-KL2			
6362660002 MEM-M08NS/H10-K2		6362661003 MEM-M10NS/H10-K2				6362662004 MEM-M12NS/H10-K2	6362662005 MEK-M12NS/H10-K2
6363860033 MEM-M08NB/H11-K2		6363861034 MEM-M10NB/H11-K2				6363862035 MEM-M12NB/H11-K2	6363862036 MEK-M12NB/H11-K2

4.5–24 V	10–30 V	4.5–24 V	10–39 V	10–39 V	4.5–24 V	4.5–24 V
25 mA	200 mA	25 mA	400 mA	400 mA	25 mA	25 mA
20 kHz	1500 Hz	20 kHz	10 kHz	10 kHz	20 kHz	20 kHz
-/-	-/-	-/-	LED/-	LED/-	-/-	-/-
Current limiter	Cyclic	Current limiter	Cyclic	Cyclic	Current limiter	Current limiter

-25°C/+70°C	-25°C/+70°C	-25°C/+70°C	-25°C/+70°C	-25°C/+70°C	-25°C/+70°C	-25°C/+70°C
IP67	IP67	IP67	IP67	IP67	IP67	IP67
CuZn39Pb3	CuZn39Pb3	CuZn39Pb3	CuZn39Pb3	CuZn39Pb3	CuZn39Pb3	PA
3 x 0.14 mm ²	3 x 0.14 mm ²	3 x 0.14 mm ²	3 x 0.14 mm ²	3 x 0.14 mm ²	3 x 0.14 mm ²	3 x 0.14 mm ²

You will find detailed data sheets to the products under www.bernstein.eu

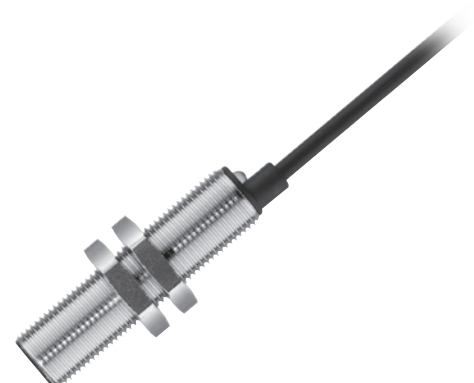

Electronic Magnetic Sensors (Type M12, M18)

Type	M12		M12		M12	
Operating mode	Hall	Hall	Hall	MR	MR	MR
Magnetic sensitivity (mT)	10 mT	10 mT	10 mT	1 mT	1 mT	1 mT
Sensing distance (S _n)	17 mm	17 mm	17 mm	45 mm	45 mm	45 mm
Reference magnet (Page)	T-62 N/S	T-62 N/S	T-62 N/S	T-62 N/S	T-62 N/S	T-62 N/S
Type of connection	Cable 2 m	Cable 10 m	Cable 2 m	Cable 2 m	Cable 5 m	Cable 2 m
Special feature						

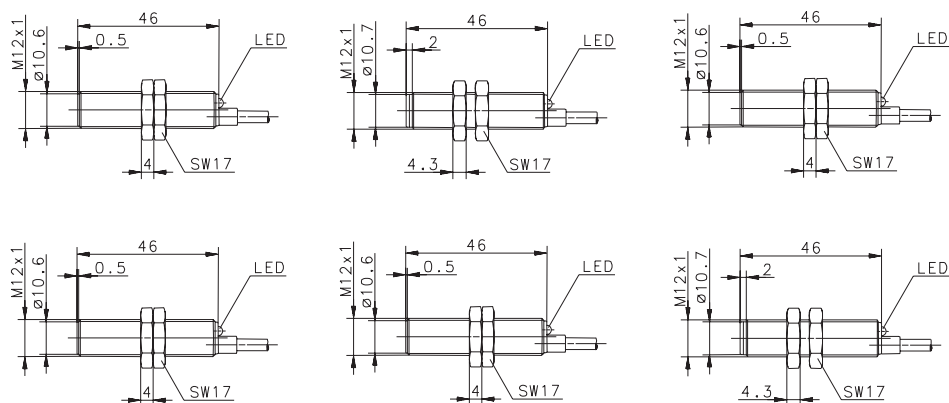

PNP	NO contact Type NC contact Type Bistable Type	6372262090 MEM-M12PS/H10-KL2 6372162092 MEM-M12PÖ/H10-KL2 6373462126 MEM-M12PB/H11-KL2	6472262077 MEM-M12PS/H10-KL10	6372262089 MEK-M12PS/H10-KL2 6372162091 MEK-M12PÖ/H10-KL2 6373462125 MEK-M12PB/H11-KL2	6373262094 MEM-M12PS/M01-KL2 6373162096 MEM-M12PÖ/M01-KL2	6373262123 MEM-M12PS/M01-KL5	6373262093 MEK-M12PS/M01-KL2 6373162095 MEK-M12PÖ/M01-KL2
NPN	NO contact Type NC contact Bistable Type						
Analogue	Current output Voltage output						

Technical data		6372262090	6472262077	6372262089	6373262094	6373262123	6373262093
Rated operating voltage	U _B	10–39 VDC	10–39 VDC	10–39 VDC	10–39 VDC	10–39 VDC	10–39 VDC
Rated operating current	I _e	400 mA	400 mA	400 mA	400 mA	400 mA	400 mA
Max. switching voltage	F	10 kHz	10 kHz	10 kHz	10 kHz	1500 Hz	10 kHz
Function/operating voltage indicator		LED/-	LED/-	LED/-	LED/-	LED/-	LED/-
Sensitivity adjustable							
Short circuit-protection		Cyclic	Cyclic	Cyclic	Cyclic	Cyclic	Cyclic
Teachable							

Mechanical data		6372262090	6472262077	6372262089	6373262094	6373262123	6373262093
Ambient temperature (min/max)		-25°C/+70°C	-25°C/+70°C	-25°C/+70°C	-25°C/+70°C	-25°C/+70°C	-25°C/+70°C
Protection class in accordance with IEC 529, EN 60529		IP67	IP67	IP67	IP67	IP67	IP67
Enclosure material		CuZn39Pb3	CuZn39Pb3	PA	CuZn39Pb3	CuZn39Pb3	PA
Connection		3 x 0.14 mm ²	3 x 0.14 mm ²	3 x 0.14 mm ²	3 x 0.14 mm ²	3 x 0.14 mm ²	3 x 0.14 mm ²

Please refer to Accessories for magnets, mounting brackets, cable couplers and sensor tester.

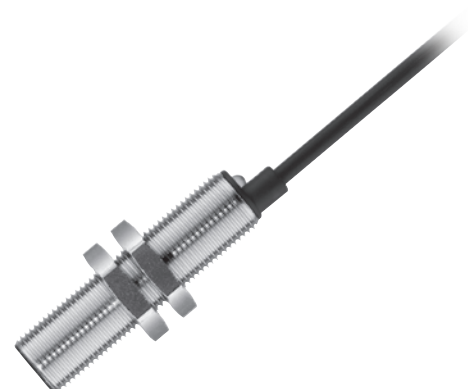

M12		M12		M18		M18	
Hall	Hall	Hall	Hall	Hall	Hall	Hall	Hall
-	-	-	-	10 mT	10 mT	10 mT	10 mT
0-2 mm	0-2 mm	0-2 mm	0-2 mm	17 mm	17 mm	17 mm	17 mm
-	-	-	-	T-62 N/S	T-62 N/S	T-62 N/S	T-62 N/S
Cable 2 m	Cable 2 m	Cable 2 m	Cable 2 m	Cable 2 m	Cable 2 m	Cable 2 m	Cable 2 m
Speed	Speed	Speed	Speed				

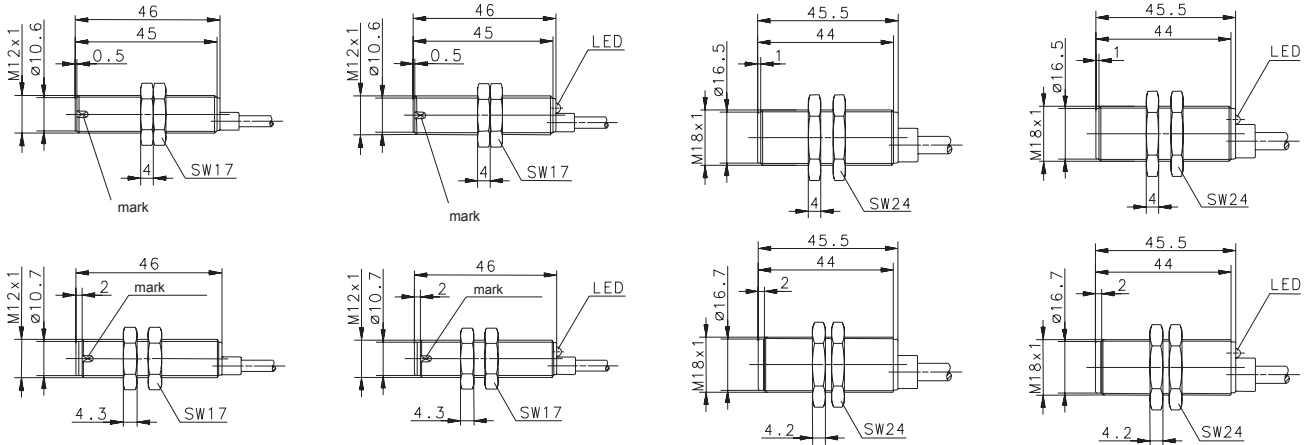

		6379262120 MEM-M12PD/H-KL2	6379262119 MEK-M12PD/H-KL2			6372263098 MEM-M18PS/H10-KL2	6372263097 MEK-M18PS/H10-KL2
						6372163100 MEM-M18PÖ/H10-KL2	6372163099 MEK-M18PÖ/H10-KL2
						6373463128 MEM-M18PB/H11-KL2	6373463127 MEK-M18PB/H11-KL2
6369662028 MEM-M12ND/H-K2	6369662027 MEK-M12ND/H-K2			6362663006 MEM-M18NS/H10-K2	6362663007 MEK-M18NS/H10-K2		
				6363863037 MEM-M18NB/H11-K2	6363863038 MEK-M18NB/H11-K2		

10-36 V	10-36 V	10-39 V	10-39 V	4.5-24 V	4.5-24 V	10-39 V	10-39 V
< 20 mA	< 20 mA	400 mA	400 mA	25 mA	25 mA	400 mA	400 mA
20 kHz	20 kHz	10 kHz	10 kHz	20 kHz	20 kHz	10 kHz	10 kHz
-/-	-/-	LED/-	LED/-	-/-	-/-	LED/-	LED/-
Cyclic	Cyclic	Cyclic	Cyclic	Current limiter	Current limiter	Cyclic	Cyclic

-25°C/+70°C	-25°C/+70°C	-25°C/+70°C	-25°C/+70°C	-25°C/+70°C	-25°C/+70°C	-25°C/+70°C	-25°C/+70°C
IP67	IP67	IP67	IP67	IP67	IP67	IP67	IP67
CuZn39Pb3	PA, red	CuZn39Pb3	PA, red	CuZn39Pb3	PBT	CuZn39Pb3	PBT
3 x 0.14 mm ²	3 x 0.14 mm ²	3 x 0.14 mm ²	3 x 0.14 mm ²	3 x 0.14 mm ²	3 x 0.14 mm ²	3 x 0.14 mm ²	3 x 0.14 mm ²

You will find detailed data sheets to the products under www.bernstein.eu

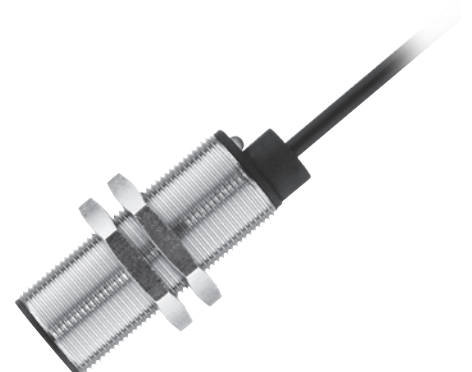

Electronic Magnetic Sensors (Type M18, Q05, Q08, Q12, E27, E29)

Type	M18		M18		Q05
Operating mode	MR	MR	Hall	Hall	MR
Magnetic sensitivity (mT)	1 mT	1 mT	-	-	3 mT
Sensing distance (S _n)	45 mm	45 mm	0 – 2 mm	0 – 2 mm	10 mm
Reference magnet (Page)	T-62 N/S	T-62 N/S	-	-	T-62 N/S
Type of connection	Cable 2 m	Cable 2 m	Cable 2 m	Cable 2 m	Cable 2 m
Special feature			Speed	Speed	

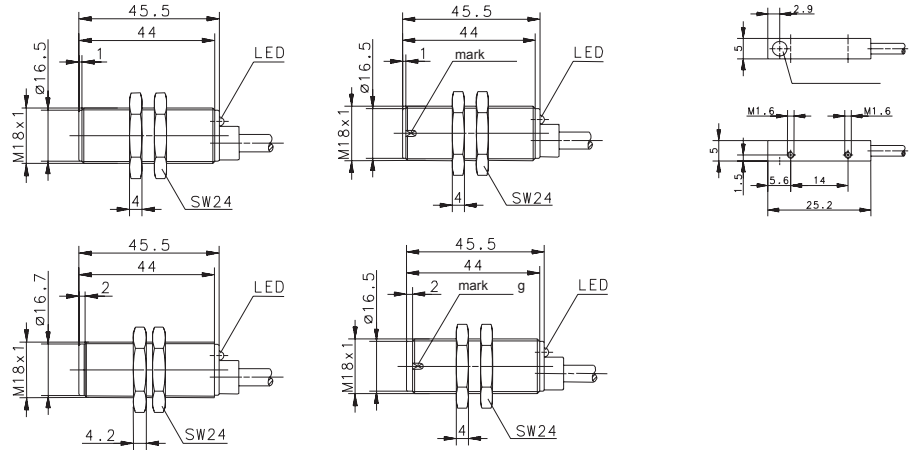

PNP	NPN	Analogue	6373263102	6373263101	6379263122	6379263121	6373299134
NO contact	NO contact	Current output	MEM-M18PS/M01-KL2	MEK-M18PS/M01-KL2	MEM-M18PD/H-KL2	MEK-M18PD/H-KL2	MEM-Q05PS/M03-K2
Type	Type	Voltage output					
NC contact	NC contact		6373163104	6373163103			
Type	Type		MEM-M18PÖ/M01-KL2	MEK-M18PÖ/M01-KL2			
Bistable	Bistable						
Type	Type						

Technical data	6373263102	6373263101	6379263122	6379263121	6373299134
Rated operating voltage U _B	10–39 VDC	10–39 VDC	10–39 VDC	10–39 VDC	4.5–30 VDC
Rated operating current I _e	400 mA	400 mA	400 mA	400 mA	200 mA
Max. switching voltage F	10 kHz	10 kHz	10 kHz	10 kHz	10 kHz
Function/operating voltage indicator	LED/-	LED/-	LED/-	LED/-	-/-
Sensitivity adjustable					
Short circuit-protection	Cyclic	Cyclic	Cyclic	Cyclic	Current limiter
Teachable					

Mechanical data	6373263102	6373263101	6379263122	6379263121	6373299134
Ambient temperature (min/max)	-25°C/+70°C	-25°C/+70°C	-25°C/+70°C	-25°C/+70°C	-20°C/+70°C
Protection class in accordance with IEC 529, EN 60529	IP67	IP67	IP67	IP67	IP67
Enclosure material	CuZn39Pb3	PBT	CuZn39Pb3	PBT, black	CuZn39Pb3
Connection	3 x 0.14 mm ²	3 x 0.14 mm ²	3 x 0.14 mm ²	3 x 0.14 mm ²	3 x 0.05 mm ²

Please refer to Accessories for magnets, mounting brackets, cable couplers and sensor tester.



Q08		Q12		E27		E29
Hall	MR	Hall	Hall	Hall	Hall	Hall
10 mT	2 mT	10 mT	10 mT	10 mT	2 mT	10 mT
17 mm	45 mm	17 mm	17 mm	17 mm	30 mm	17 mm
T-62 N/S	T-62 N/S	T-62 N/S	T-62 N/S	T-62 N/S	T-62 N/S	T-62 N/S
Cable 2 m	Cable 2 m	Cable 2 m	Cable 2 m	Cable 2 m	Cable 2 m	Cable 2 m

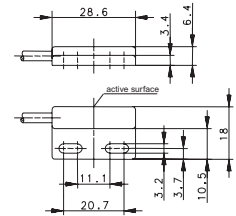
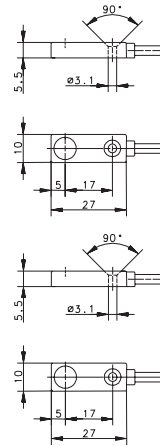
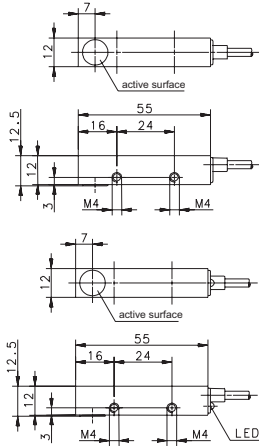
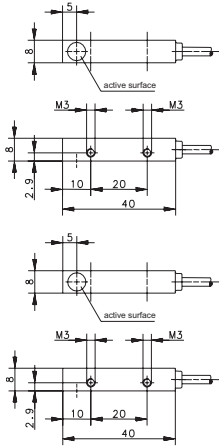

	6373280106 MEM-Q08PS/M02-K2		6372255083 MEM-Q12PS/H10-KL2 6372155084 MEM-Q12P0/H10-KL2 6373455131 MEM-Q12PB/H11-KL2			
6362680012 MEM-Q08NS/H10-K2		6362655013 MEM-Q12NS/H10-K2		6362693010 MEK-E27NS/H10-K2		6362611008 MEK-E29NS/H10-K2
6363880043 MEM-Q08NB/H11-K2		6363855044 MEM-Q12NB/H11-K2		6363893041 MEK-E27NB/H11-K2	6363893031 MEK-E27NB/H02-K2	6363811039 MEK-E29NB/H11-K2

4.5–24 VDC	10–30 VDC	4.5–24 VDC	10–39 VDC	4.5–24 VDC	4.5–24 VDC	4.5–24 VDC
25 mA	200 mA	25 mA	400 mA	25 mA	25 mA	25 mA
20 kHz	1500 Hz	20 kHz	10 kHz	20 kHz	20 kHz	20 kHz
-/-	-/-	-/-	LED/-	-/-	-/-	-/-
Current limiter	Cyclic	Current limiter	Cyclic	Current limiter	Current limiter	Current limiter

-25°C/+70°C	-25°C/+70°C	-25°C/+70°C	-25°C/+70°C	-25°C/+70°C	-25°C/+70°C	-25°C/+70°C
IP67	IP67	IP67	IP67	IP67	IP67	IP67
CuZn39Pb3	CuZn39Pb3	CuZn39Pb3	CuZn39Pb3	PA	PA	PA
3 x 0.14 mm ²	3 x 0.14 mm ²	3 x 0.14 mm ²	3 x 0.14 mm ²	3 x 0.14 mm ²	3 x 0.14 mm ²	3 x 0.14 mm ²

You will find detailed data sheets to the products under www.bernstein.eu



Electronic Magnetic Sensors (Type E45, E50, E90)

Type	E45		E45	E50	
Operating mode	Hall	Hall	MR	Hall	Hall
Magnetic sensitivity (mT)	10 mT	10 mT	3 mT	10 mT	10 mT
Sensing distance (Sn)	17 mm	17 mm	20 mm	17 mm	17 mm
Reference magnet (Page)	T-62 N/S	T-62 N/S	T-62 N/S	T-62 N/S	T-62 N/S
Type of connection	Cable 2 m	Cable 2 m	Cable 1 m	Cable 2 m	Cable 2 m
Special feature					

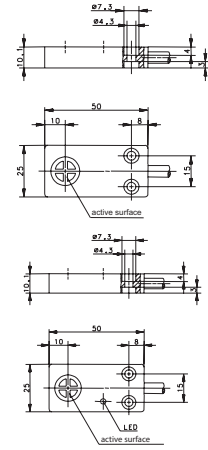
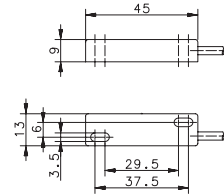
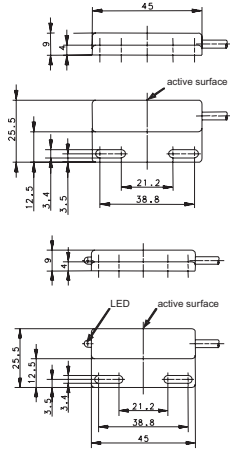

PNP	NO contact	6372245079 MEK-E45PS/H10-KL2	6372145080 MEK-E45PÖ/H10-KL2	6370401203 MEK-E45PB/M03-1	6372290081 MEK-E50PS/H10-KL2
	NC contact				
NPN	NO contact	6362645009 MEK-E45NS/H10-K2	6363845040 MEK-E45NB/H11-K2	6362690011 MEK-E50NS/H10-K2	6373490130 MEK-E50PB/H11-KL2
	NC contact				
Analogue	Current output				
	Voltage output				

Technical data

Rated operating voltage	U_B	4.5–24 VDC	10–39 VDC	10–60 VDC	4.5–24 VDC	10–39 VDC
Rated operating current	I_e	25 mA	400 mA	200 mA	25 mA	400 mA
Max. switching voltage	F	20 kHz	10 kHz	20 Hz	20 kHz	10 kHz
Function/operating voltage indicator		–/–	LED/–	–/–	–/–	LED/–
Sensitivity adjustable						
Short circuit-protection		Current limiter	Cyclic	–	Current limiter	Cyclic
Teachable						

Mechanical data

Ambient temperature (min/max)		–25°C/+70°C	–25°C/+70°C	–5°C/+70°C	–25°C/+70°C	–25°C/+70°C
Protection class in accordance with IEC 529, EN 60529		IP67	IP67	IP67	IP67	IP67
Enclosure material		PA	PA	PA	PBT	PBT
Connection		3 x 0.14 mm ²	3 x 0.14 mm ²	2 x 0,14 mm ²	3 x 0.50 mm ²	3 x 0.50 mm ²

Please refer to Accessories for magnets, mounting brackets, cable couplers and sensor tester.



E90			
MR			
3 mT			
20 mm			
T-62 N/S			
Cable 1 m			

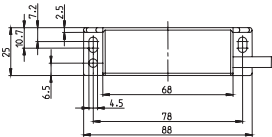
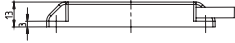

6370442204							
MEK-E90PB/M03-1							

10-60 VDC			
200 mA			
20 Hz			
-/-			
-			

-5°C/+70°C			
IP67			
PA			
2 x 0,50 mm ²			

You will find detailed data sheets to the products under www.bernstein.eu



Notes

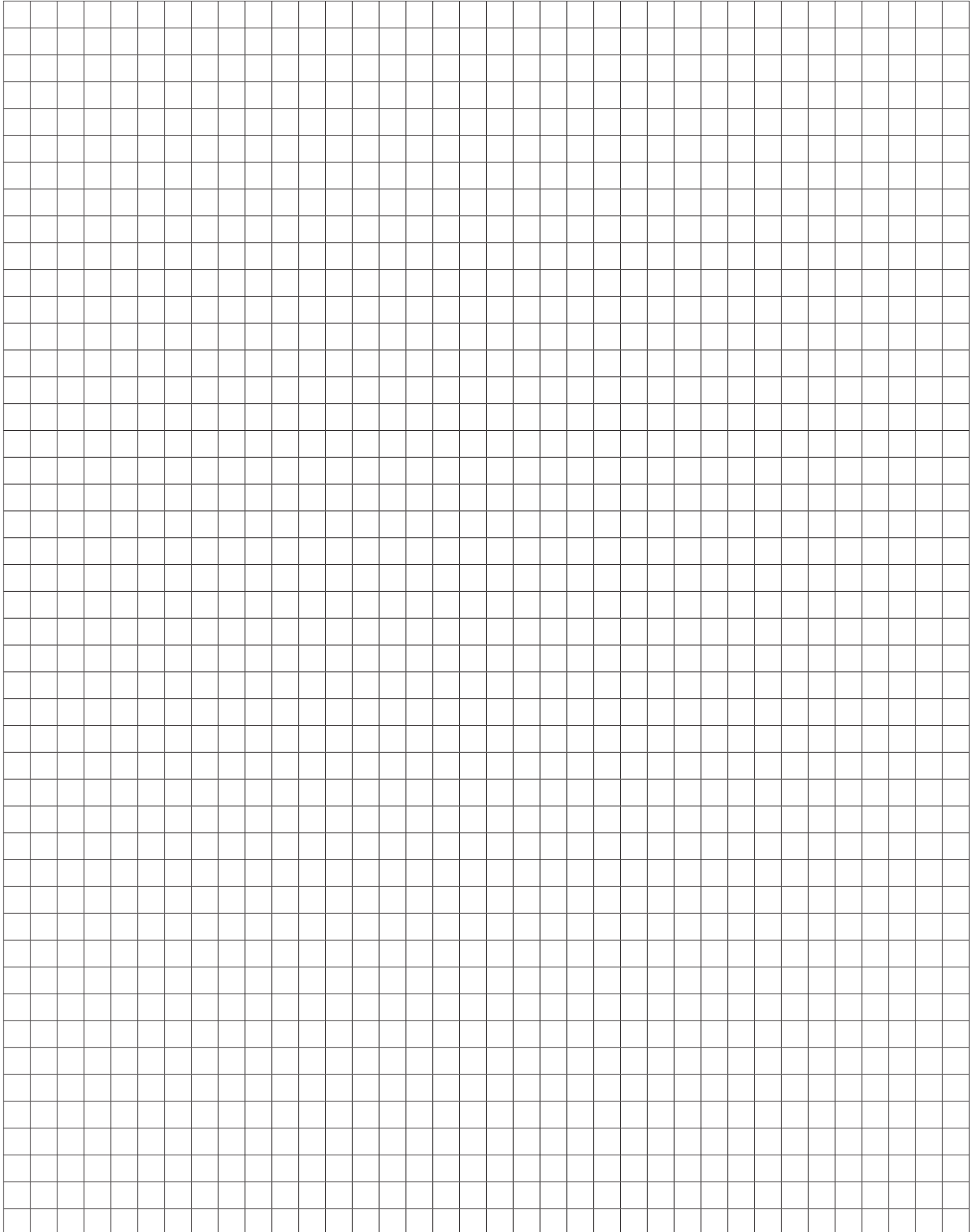

Programmable Miniature Position Sensors with Fully Integrated Electronics

The teachable magnetic sensors are characterised by one or two freely programmable, independent switching points. Despite this high degree of functionality, BERNSTEIN has succeeded in integrating the entire electronics into a compact sensor enclosure with the smallest possible dimensions. This design feature renders additional protection (e.g. for the cable electronics or high-cost safeguards) unnecessary.

The compact design is suitable for installation in all standard T- and C-slots (e.g. FESTO or SMC). In an installed position, the freely programmable switching points can be quickly and easily set with the aid of the easy-to-use teach-in tool.

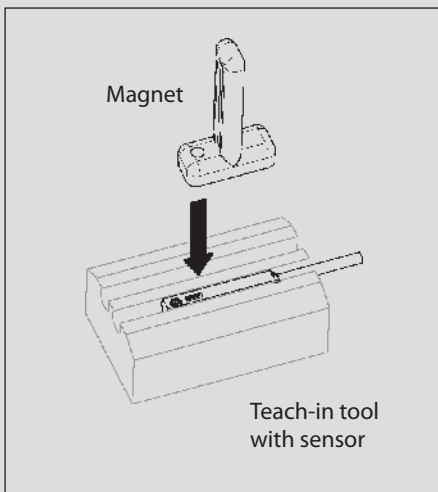

This configuration largely avoids unintentional changes to the settings and substantially increases the resistance to environmental influences while retaining the protection class rating.

Manually searching for the switching points has been replaced by rapid electronic balancing with the sensor installed in position. LEDs at the top of the sensor serve as the function indicator, provide information on the programming status and also signal faults. In addition to featuring effective polarity reversal protection as standard, the sensors also have an internal EEPROM that stores the switching points in the event of power failure.

Advantages

- Completely integrated electronic solution
- Permanent protection rating
- No need for additional electronics
- Fully immersed and therefore protected installation in the slot
- Suitable for standard C- and T-slots
- Available as cable or plug version
- Occupies only one slot
- Freely programmable switching points
- Straightforward teach-in procedure
- Reduced installation and wiring requirements
- Can be fitted from above
- High switching accuracy

- The installed sensor assumes programming mode when the teach-in tool is placed over it
- The positions of the magnet are assigned to the respective outputs by correspondingly aligning the tool
- The programmable switching points are stored in the sensor
- The switching points can be changed by repeating the teach-in procedure

Technical data

- PNP/NO contact
- Magnetic sensitivity $\pm 1.5 \text{ mT}$ to $\pm 13.5 \text{ mT}$
- Sensing distance up to 50 mm (depending on magnet/air gap)
- Repeat accuracy $\leq 0.1 \text{ mT}$
- Hysteresis $1 \text{ mT} \leq H \leq 1.35 \text{ mT}$
- Operating voltage range 10 – 30 V DC
- Output current $I_e \leq 50 \text{ mA}$ (one output switched) $\leq 25 \text{ mA}$ per output (both outputs switched)
- Ambient temperature $-20 \text{ }^\circ\text{C}$ to $+80 \text{ }^\circ\text{C}$
- Protection class IP67

Other slot sensors

Sensors with only one output can also be used for applications that require only one switching point. For this purpose BERNSTEIN offers a range of Hall sensors with set sensitivity or reed contact versions that do not require auxiliary energy.

All sensors come with the following accessories:

- 1x setscrew M2 x 3 (E22), M3 x 6 (E30), DIN 913
- 1x Offset screwdriver (E22)
- 1x Teach-in tool
- 1x Operating and installation instructions

Standards and approvals

MEK E-22/MEA E30
EN 60947-5-2



Teachable Electronic Slot Sensors

Type	E22		E30	
Operating mode	Hall	Hall	Hall	Hall
Magnetic sensitivity (mT)	1.5 – 13.5 mT	1.5 – 13.5 mT	1.5 – 13.5 mT	1.5 – 13.5 mT
Switching function	PNP NO / 0 – 10 V	PNP NO / 0 – 10 V	PNP NO / 0 – 10 V	PNP NO / 0 – 10 V
Reference magnet (Page)				
Type of connection	Cable 2 m	Connector M8	Cable 2 m	Connector M8

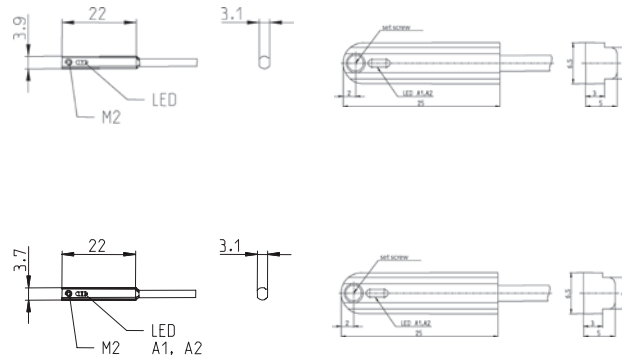

Type Double-channel	C-slot SMC Type C-slot Festo Type T-slot Type	6370281183 MEK-E22PS/HP2-KL2 6370281185 MEK-E22PS/HP2-KL2	6370281184 MEK-E22PS/HP2-KL0,3S8 6370281186 MEK-E22PS/HP2-KL0,3S8	6370299187 MEA-E30PS/HP2-KL2	6370299188 MEA-E30PS/HP2-KL0,3S8		
Type Single-channel	C-slot SMC Type C-slot Festo Type T-slot Type	6372281177 MEK-E22PS/HP1-KL2 6372281179 MEK-E22PS/HP1-KL2	6372281178 MEK-E22PS/HP1-KL0,3S8 6372281180 MEK-E22PS/HP1-KL0,3S8	6372299181 MEA-E30PS/HP1-KL2	6372299182 MEA-E30PS/HP1-KL0,3S8		
Analogue 0 – 10 V	T-slot Type				6370099169 MEA-E30A10/H50-KL0,3S8		

Technical data

Rated operating voltage	U_B	10–30 VDC	10–30 VDC	10–30 VDC	10–30 VDC
Rated operating current	I_e	≤ 50 mA	≤ 50 mA	≤ 50 mA	≤ 50 mA
Max. switching voltage	F				
Function/operating voltage indicator		LED/–	LED/–	LED/–	LED/–
Sensitivity adjustable		Yes	Yes	Yes	Yes
Short circuit-protection		Cyclic	Cyclic	Cyclic	Cyclic
Teachable		Yes	Yes	Yes	Yes

Mechanical data

Ambient temperature (min/max)					
Single-channel / Double-channel		–20°C/+80°C	–20°C/+80°C	–20°C/+80°C	–20°C/+80°C
Analogue 1 – 10 V				+5°C/+55°C	
Protection class in accordance with IEC 529, EN 60529		IP67	IP67	IP67	IP67
Enclosure material		PA	PA	Aluminium	Aluminium
Connection		4 x 0.05 mm ²	M8 x 1	4 x 0.05 mm ²	M8 x 1

Please refer to Accessories for magnets, mounting brackets, cable couplers and sensor tester.



Type	E22		E30	
Operating mode	Hall	Hall	Hall	Hall
Magnetic sensitivity (mT)	3 mT	3 mT	3 mT	3 mT
Switching function	PNP NO	PNP NO	PNP NO	PNP NO
Reference magnet (Page)				
Type of connection	Cable 2 m	Connector M8	Cable 2 m	Connector M8

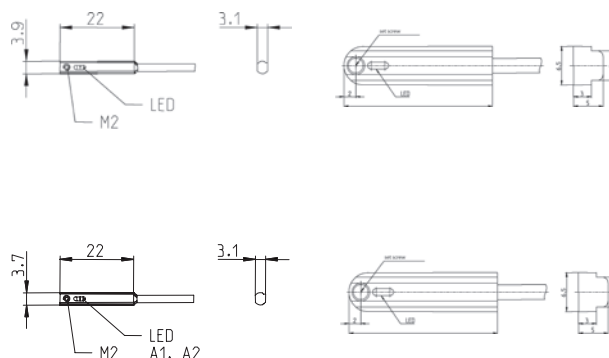

Type	C-slot SMC Type	6372281171	6372281172			
	C-slot Festo Type	MEK-E22PS/H03-KL2	MEK-E22PS/H03-KL0,3S8			
	T-slot Type	6372281173	6372281174			
		MEK-E22PS/H03-KL2	MEK-E22PS/H03-KL0,3S8	6372299175	6372299176	
				MEA-E30PS/H03-KL2	MEA-E30PS/H03-KL0,3S8	

Technical data

Rated operating voltage	U_B	10–30 VDC	10–30 VDC	10–30 VDC	10–30 VDC
Rated operating current	I_e	≤ 50 mA	≤ 50 mA	≤ 50 mA	≤ 50 mA
Max. switching voltage	F				
Function/operating voltage indicator		LED/–	LED/–	LED/–	LED/–
Sensitivity adjustable		Yes	Yes	Yes	Yes
Short circuit-protection		Cyclic	Cyclic	Cyclic	Cyclic
Teachable		–	–	–	–

Mechanical data

Ambient temperature (min/max)		–20°C/+80°C	–20°C/+80°C	–20°C/+80°C	–20°C/+80°C
Protection class in accordance with IEC 529, EN 60529		IP67	IP67	IP67	IP67
Enclosure material		PA	PA	Aluminium	Aluminium
Connection		3 x 0.05 mm ²	M8 x 1	3 x 0.05 mm ²	M8 x 1

Please refer to Accessories for magnets, mounting brackets, cable couplers and sensor tester.



Slot Sensors with Reed Contact

Type	E22		E30	
Operating mode	Reed	Reed	Reed	Reed
Magnetic sensitivity (mT)	3 mT	3 mT	3 mT	3 mT
Switching function	NO	NO	NO	NO
Switching power	10 VA	10 VA	10 VA	10 VA
Type of connection	Cable 2 m	Connector M8	Cable 2 m	Connector M8

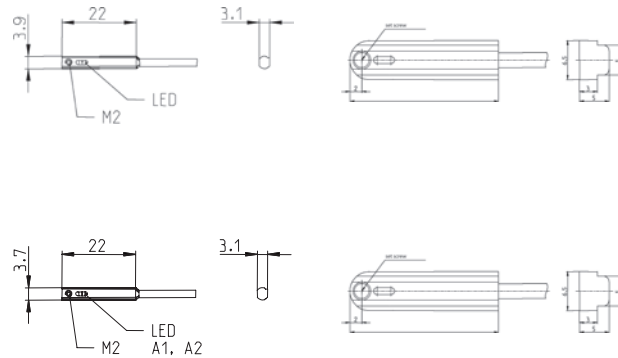

Type	C-slot SMC Type C-slot Festo Type T-slot Type	6310281741 MAK-E22S/R20-2	6310281742 MAK-E22S/R20-0,3S8	6310281743 MAK-E22S/R20-2	6310281744 MAK-E22S/R20-0,3S8	6310299745 MAA-E30S/R20-2	6310299746 MAA-E30S/R20-0,3S8
------	--	-------------------------------------	---	-------------------------------------	---	-------------------------------------	---

Technical data

Rated operating voltage U_B	120 V	120 V	120 V	120 V
Performance class (diagram No.)	10 VA	10 VA	10 VA	10 VA
Shock resistance	30 g (11 ms)	30 g (11 ms)	30 g (11 ms)	30 g (11 ms)
Reproducibility	+/- 1 mm	+/- 1 mm	+/- 1 mm	+/- 1 mm
Mechanical service life (switching operations)	3×10^8	3×10^8	3×10^8	3×10^8

Mechanical data

Ambient temperature (min/max)	-25°C/+80°C	-25°C/+80°C	-25°C/+80°C	-25°C/+80°C
Protection class in accordance with IEC 529, EN 60529	IP67	IP67	IP67	IP67
Enclosure material	PA	PA	Aluminium	Aluminium
Connection	$3 \times 0.05 \text{ mm}^2$	M8 x 1	$3 \times 0.05 \text{ mm}^2$	M8 x 1

You will find detailed data sheets to the products under www.bernstein.eu



Non-contact Safety Sensor SRF



The SRF (Safety RFID) is a non-contact safety sensor, that monitors moveable safety guards, such as doors, flaps and hoods. This particularly compact sensor protects employees from injuries by shutting down or not starting up machines when the safety guard is not properly closed.

With its innovative diagnostic system, the SRF makes safety circuits suitable for Industry 4.0.

The system provides a multitude of diagnostic data of each sensor, even in a series connection, to support smart production.

Diagnostic data is fed into the machine control system via I/O Link or alternatively displayed on a smartphone by way of NFC technology. In this way, 20 different diagnostic information of each sensor can be retrieved and made available.

This diagnostic data delivers cost-effective predictive maintenance in a simple way. Through its advanced fault recognition capability, costly machine shutdowns can be prevented.

This way, your machinery and plant will work even more efficiently!



Innovative

- New innovative Daisychain Diagnostics (DCD)
- Reading diagnostics information through Android smartphone via NFC interface
- Transmission of data via I/O Link interface
- Simple and specific maintenance thanks to pre-failure monitoring
- Cost reduction by eliminating machine downtimes
- Connecting the sensor information of six different diagnostic circuits
- Support of an energy-optimised application: Voltage levels known at any time

Safe

- Safe sensors in Cat. 4, PL e or SIL CL 3
- Safe serial connection of SRF up to PL e, Cat. 4 / SIL CL 3
- Coded and unique actuator

Versatile

- Protection class of IP69
- Local reset button
- Compact design
- Diagnostics system DCD
- PNP diagnostics
- Fault tolerant output
- Single and series connection possible
- Connection via M12 plug

Non-contact Safety Sensor SRF

Benefits and advantages SRF

- **Cost-saving:** thanks to a four-wire unshielded standard connection cable from sensor to sensor ❶
- **Compact:** small in size, flexible in use
- **Safe:** up to PL e – even in series connection, with high defeat protection (according to ISO 14119)
- Series connection of the sensors through internal safety electronics without compromising the safety level

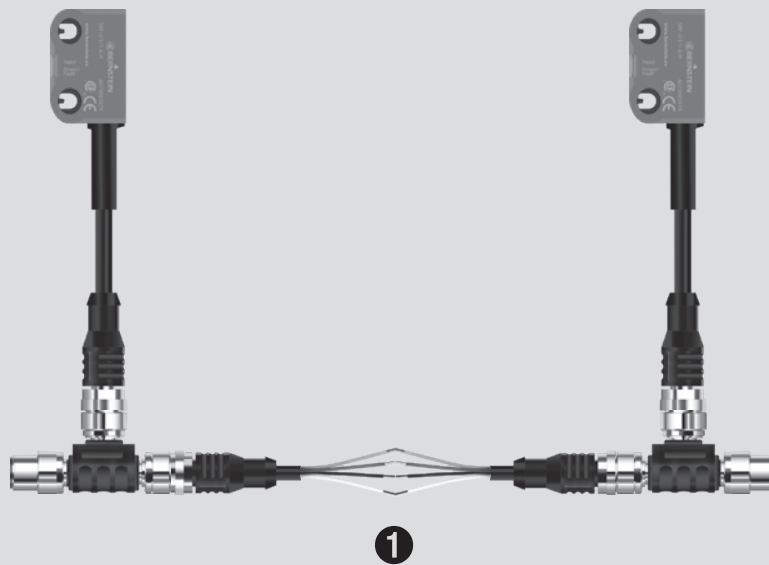

Coding types

- Low coding level:
Coded sensor with only one possible code
- High coding level:
Coded sensor with more than 1000 different codes
- Unique coding: High coding level – but no spare actuator accepted

Diagnostics (not safety related)

- PNP diagnostics:
Signalling contact as PNP NO output that indicates whether the safety guard is closed
- DCD System:
Detailed diagnostic system DCD that submits a complete status image of a sensor, even in series connection

Reset function

Local reset of the sensor to enable restart of the machine.

Fault tolerant outputs

The fault tolerant outputs prevent an unexpected machine stop and allow to run down the machine in a controlled manner.

This is how it works:

If an error is detected at one output, the sensor indicates this with a flash code –whilst simultaneously transmitting the information via the DCD system. After 20 minutes, the second still intact output, will switch off.

Benefits and advantages diagnostics

- Comprehensive diagnostics information for each sensor and for the entire system
- Diagnostic data simply retrievable
- Time and cost savings during commissioning, maintenance and fault investigation
- Protection against unexpected machine stops through pre-fault detection
- Display of diagnostic data on smartphones via NFC
- Simple troubleshooting through reading out the fault memory via NFC also in case of missing power supply

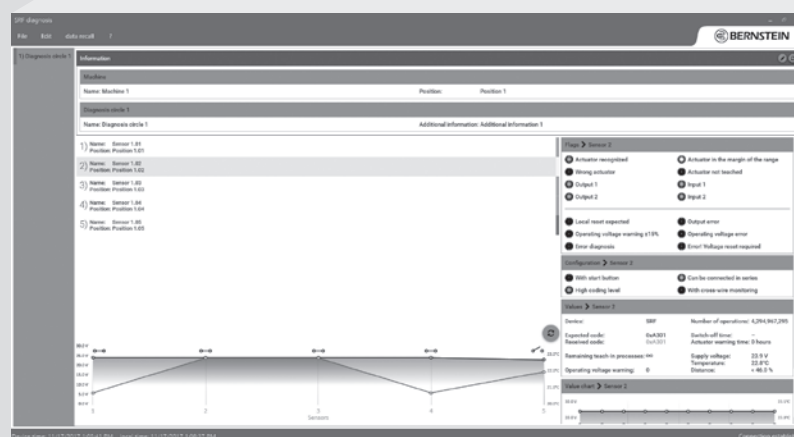
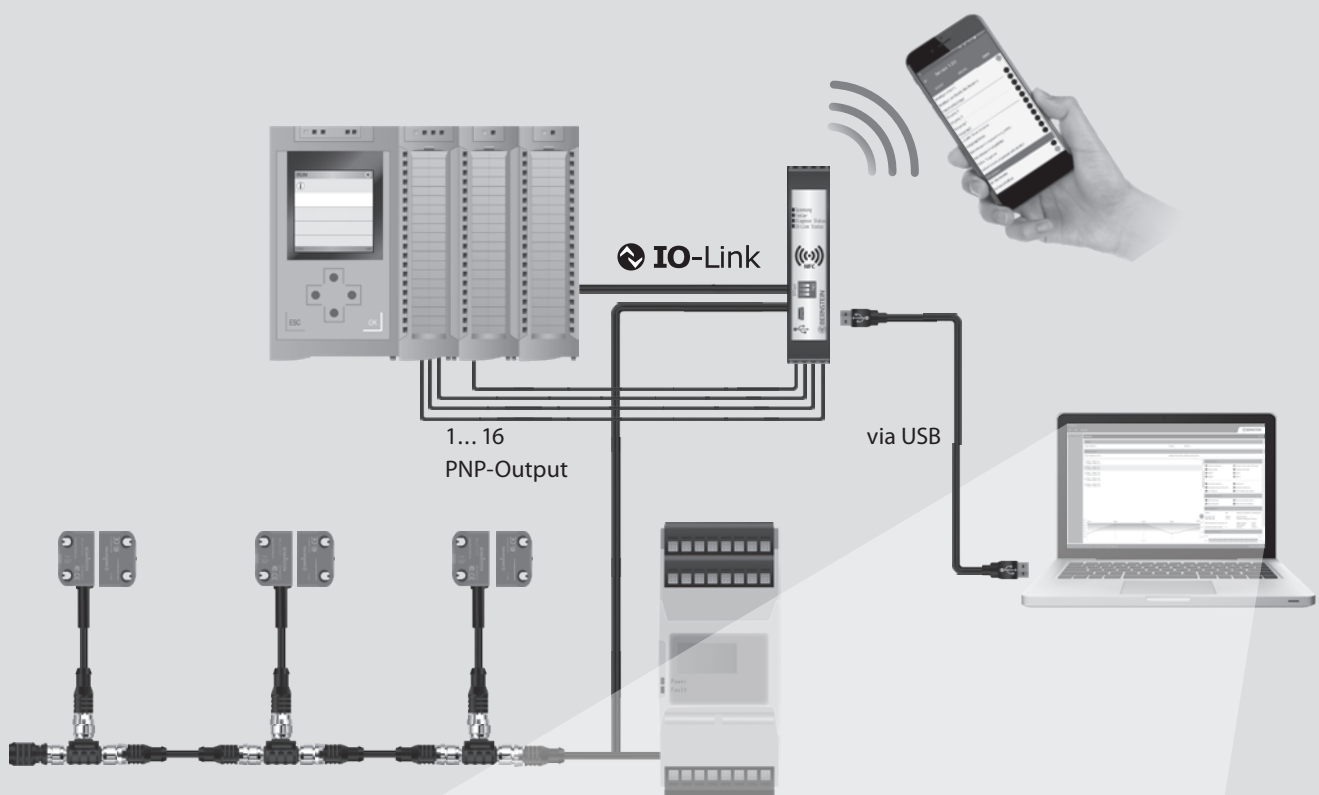

Non-contact Safety Sensor SRF

SRF for series connection

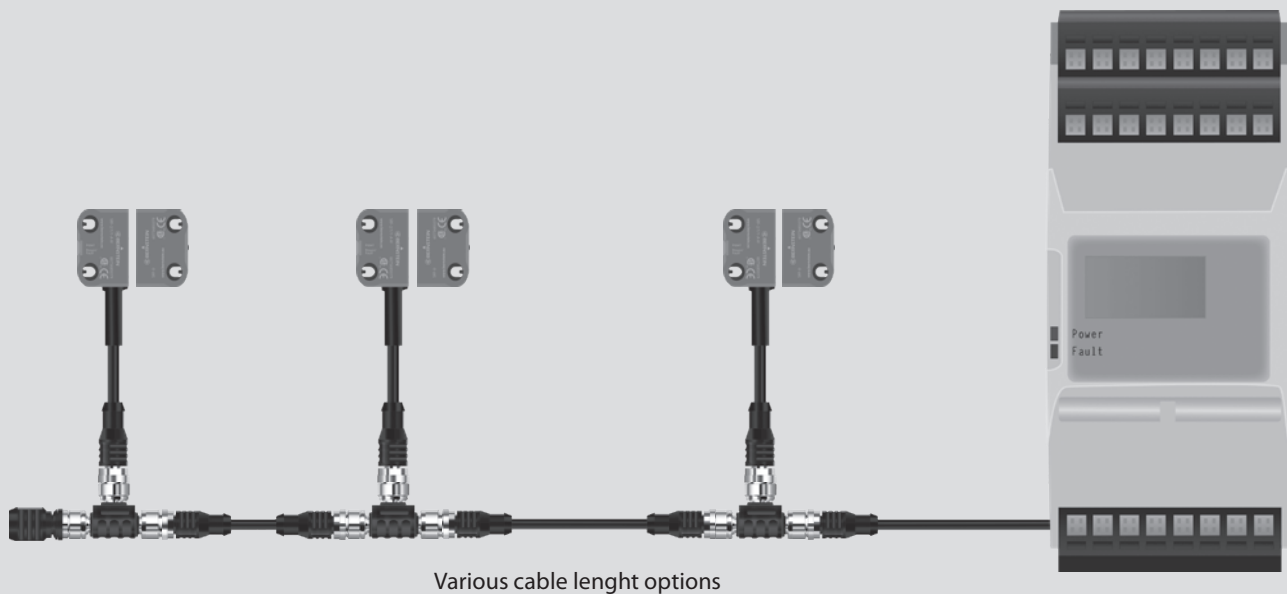

Article number	Designation	Unique	High coding level	Low coding level	PNP diagnostics	Daisychain diagnostics (DCD)	Reset input	M12 8-pin connection with 25 cm cable
6075685094	SRF-4/1/1-E0.25-U	x			x			x
6075685095	SRF-4/1/1-E0.25-H		x		x			x
6075685096	SRF-4/1/1-E0.25-L			x	x			x
6075685097	SRF-4/2/1-E0.25-U	x			x		x	x
6075685098	SRF-4/2/1-E0.25-H		x		x		x	x
6075685099	SRF-4/2/1-E0.25-L			x	x		x	x
6075685100	SRF-5/1/1-E0.25-U	x				x		x
6075685101	SRF-5/1/1-E0.25-H		x			x		x
6075685102	SRF-5/1/1-E0.25-L			x		x		x
6075685080	SRF-5/2/1-E0.25-U	x				x	x	x
6075685103	SRF-5/2/1-E0.25-H		x			x	x	x
6075685104	SRF-5/2/1-E0.25-L			x		x	x	x
6075687078	SRF-0	Actuator SRF, suitable for all coding levels (not included, please order separately)						

SRF for single connection

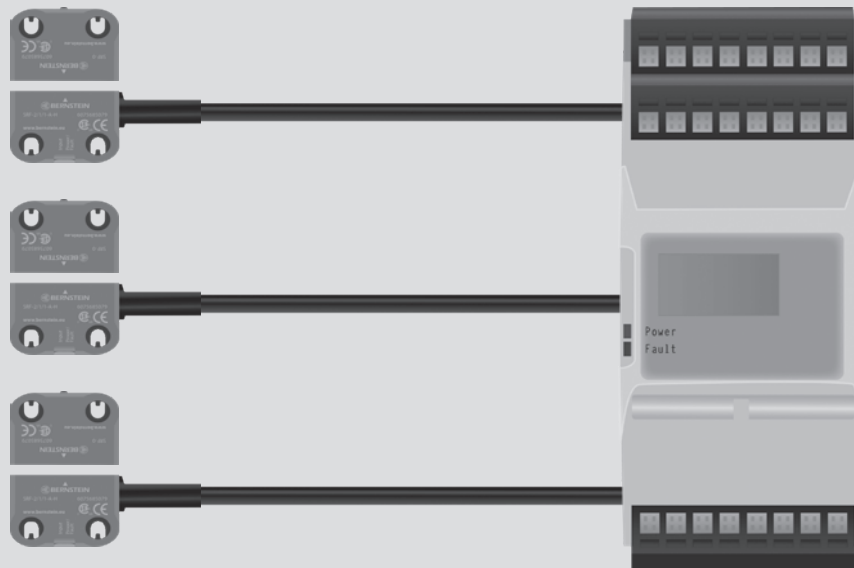

Article number	Designation	Unique	High coding level	Low coding level	PNP diagnostics	M12 5-pin connection with 25 cm cable	2 m cable with open cable end	
6075685117	SRF-2/1/1-A2-U	x			x		x	
6075685079	SRF-2/1/1-A2-H		x		x		x	
6075685118	SRF-2/1/1-A2-L			x	x		x	
6075685119	SRF-2/1/1-E0.25-U	x			x	x		
6075685120	SRF-2/1/1-E0.25-H		x		x	x		
6075685121	SRF-2/1/1-E0.25-L			x	x	x		
6075687078	SRF-0	Actuator SRF, suitable for all coding levels (not included, please order separately)						

Non-contact Safety Sensor SRF

Diagnostic module



Article number	Designation	Enclosure	Number of diagnostic circuits	Digital output	Interfaces		
					I/O Link	NFC	USB 2.0
6075619122	SRF DI-C-0/1-T	DIN rail housing 22.5 mm	1	-	X	X	X
6075619123	SRF DI-C-8/1-T	DIN rail housing 22.5 mm	1	8	X	X	X
6075619124	SRF DI-C-16/1-T	DIN rail housing 22.5 mm	1	16	X	X	X
6075619125	SRF DI6-C-0/1-T	DIN rail housing 22.5 mm	6	-	X	X	X
6075689126	SRF DI-F-0/2-E0.25	Rectangular sensor enclosure (use directly at the machine)	1	-	X	X	

Accessories

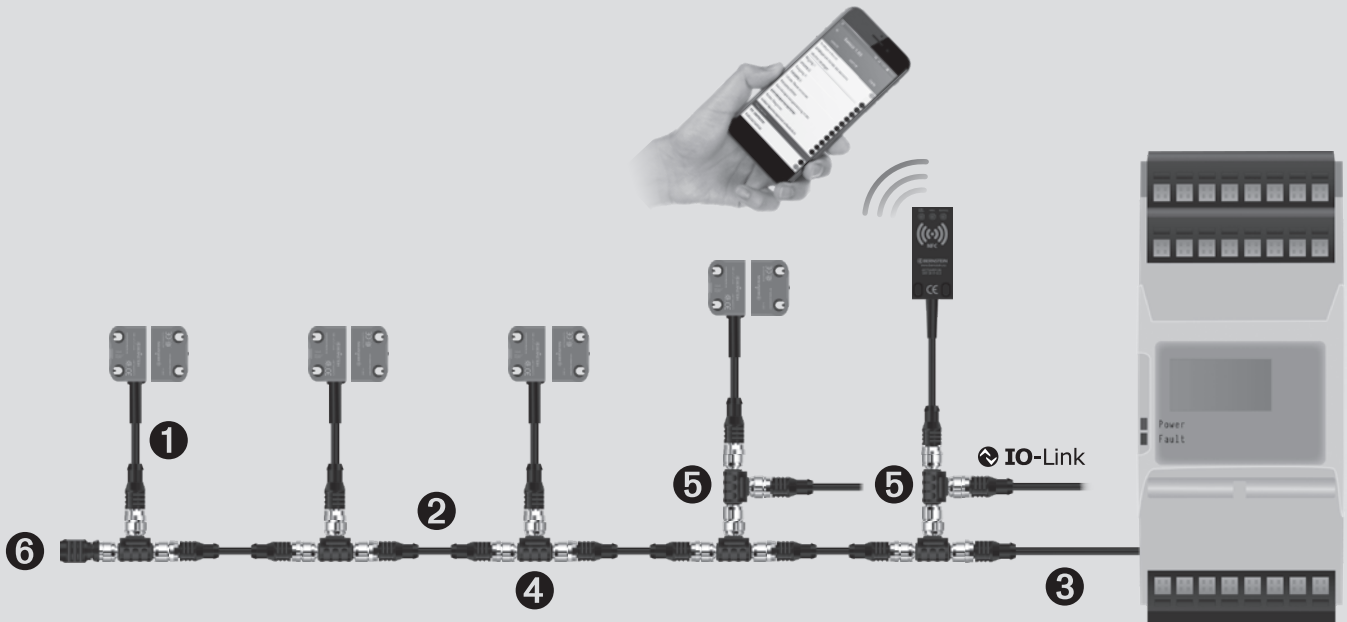

Connection cable and connecting cable

Pos.-Nr.	Article number	Designation	Description	Plug alignment	Plug 1	Plug 2	Number of plugs	Cable length in meter
1	6075689085	S1W-M12A8/BW-1PU	Connecting cable	straight	M	F	8	1
1	6075689086	S1W-M12A8/BW-2PU	Connecting cable	straight	M	F	8	2
2	6075689087	S1W-M12C4/AW-2PU	Connecting cable	straight	M	F	4	2
2	6075689088	S1W-M12C4/AW-5PU	Connecting cable	straight	M	F	4	5
2	6075689089	S1W-M12C4/AW-10PU	Connecting cable	straight	M	F	4	10
3	6075689092	SFW-M12B5/AW-2PU	Connecting cable	straight	F		5	2
3	6075689093	SFW-M12B5/AW-5PU	Connecting cable	straight	F		5	2
3	6075689090	SFW-M12C4/AW-0.5PU	Connecting cable	straight	F		4	0.5
3	6075689091	SFW-M12C4/AW-2PU	Connecting cable	straight	F		4	2

T adapter, termination plug and fixing screws

Pos.-Nr.	Article number	Designation	Description
4	6075989082	ATS-M12/4-M12/8	T adapter for series connection
5	6075989083	ATD-M12/8-M12/4	T adapter for connection of I/O link and reset button
6	6075689084	AEP-M12/4	Termination plug M12
	6075689127	AT-CLIP-M12	Fixing clip for T adapter
	6075689128	One-way screw M4 x 16	10 x Fixing screws M4 x 16 One-way screw

Non-contact Safety Sensor SRF

Technical data SRF

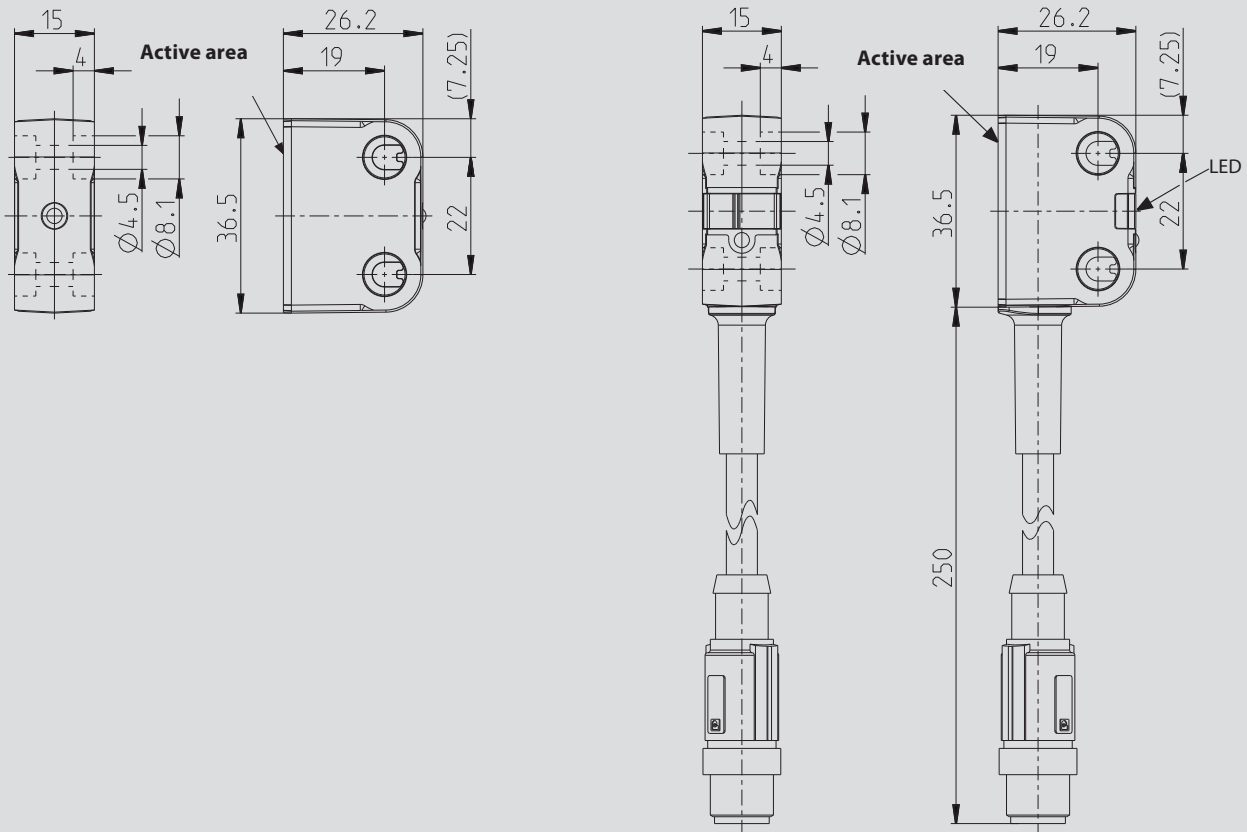

Electrical data

- Rated operational voltage U_e : 24 V
- Output current of the safety outputs I_e : 100 mA
- Output current of the message output I_e : 10 mA

Mechanical data

- Housing: PA66 + PA6, red, self-extinguishing
- Connection cable: PUR
- Mounting holes: \varnothing 4,5 (for M4 screws)
- Displays: 1 \times LED red/green operating status
1 \times LED yellow actuation status
- Ambient temperature: -25 °C to +70 °C
- Protection class: IP69

Safety data sheet

- PL e / Kat. 4 (according to EN ISO 13849-1)
- SIL CL 3 (according to DIN EN 62061)
- $PFH_D = 6 \times 10^{-9}$ 1/h
- Mission time T_M : 20 years
- Switching distance:
 - Rated operating distance S_n : 13 mm
 - Assured switching distance – On S_{ao} : 10 mm
 - Assured switching distance – Off S_{ar} : 25 mm
 - Hysteresis: 2 mm
- Switch-off delay t_a : max. 100 ms
- Ready delay t_v : max. 2 s

Technical data diagnostic module

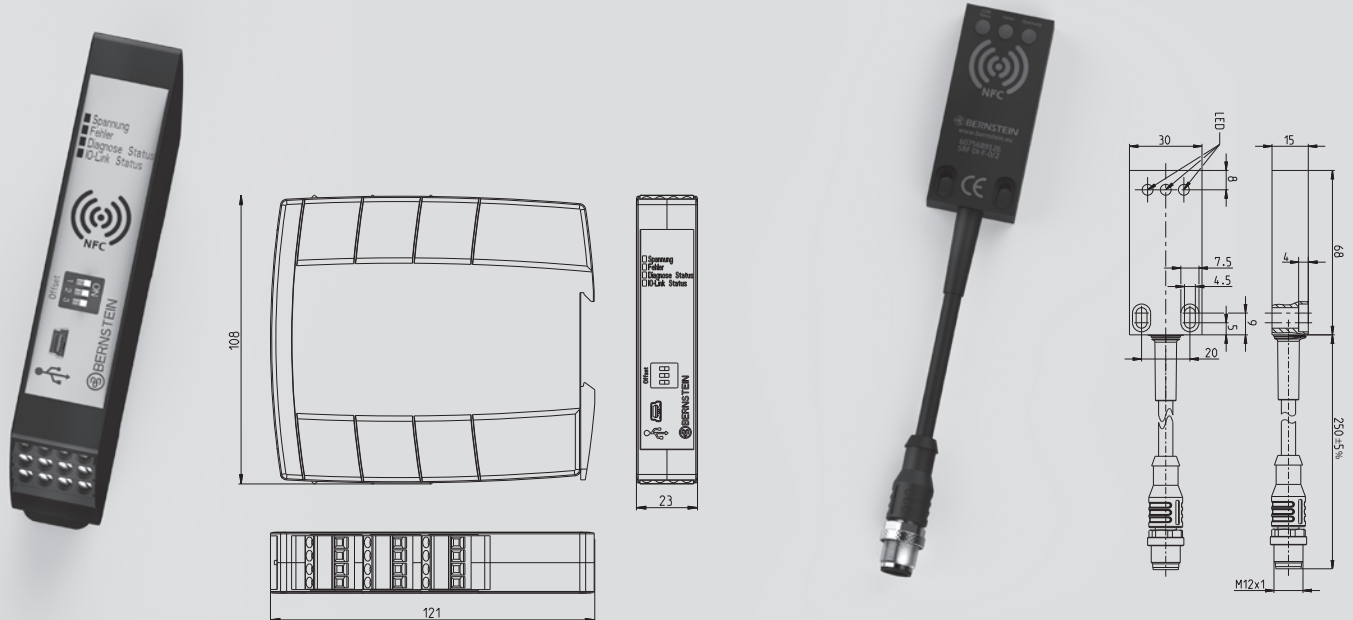

Cabinet module

- Rated operational voltage U_e : 24 V DC
- I/O Link protocol: V1.1
- Output current per signal output I_e : 50 mA
- Ambient temperature: 0 °C to +60 °C
- Protection class: IP20

Field module

- Rated operational voltage U_e : 24 V DC
- I/O Link protocol: V1.1
- Output current per signal output I_e : –
- Ambient temperature: -25 °C to +70 °C
- Protection class: IP69

Safety relay SCR ON

The SCR ON safety relay monitors the SRF's safety outputs.

Features

- PL e to ISO 13849
- 3 enabling paths
- Feedback loop with monitored / automatic reset

Article number	Designation
6075111020	SCR ON4-W22-3.6-S



Safety sensors MAK

To achieve a PL or SIL value with the MAK safety sensors, it is necessary to connect them to a safety evaluation unit. The magnetic safety sensors are dual channel versions. The evaluation unit (BERNSTEIN designation: MÜZ) monitors the correct switching of the two MAK channels and a defined time window in which the two channels must switch.

With the combination of MAK and MÜZ, a PL D and a SIL 3 can be reached. Besides the 3 different types of magnetic safety switches, BERNSTEIN also offers two different evaluation units.

Product features

- Performance Level d
- Redundancy with NO and NC contacts
- Switching distance: 6 mm
- IP67

Magnetic controllers for safety functions

BERNSTEIN offers magnetic controllers for safety functions that fulfill performance level d according to EN 13849-1 and SIL 3 according to EN 61508 or rather EN 62061.

A safety system consists of the safety magnetic controllers and a coded transducer unit.

The anti-tamper security of the transducer unit is achieved by variable coding of the actuator magnets and magnetic switches.

Depending on the type of device, one or two coded transducer units (magnetic switch with corresponding magnet) of type:

- MAK-4236
- MAK-5236
- MAK-5336

can be connected to and monitored by the safety magnetic controllers.



MAK-4236-x with magnet TK-42-CD



MAK-5236-x with magnet TK-52-CD / 2



MAK-5336-x with magnet TK-43-CD

The safety magnetic controller processes the NC or NO contact signals coming from the coded magnetic switches. Thereby, it is possible to detect the opening of the safety guard (door, hatch, protective hood etc.) and to turn off the safety output. Thanks to the redundant evaluation, the magnetic controller is switched to the "safe state" should a fault or manipulation occur, or if the time difference is exceeded between the NC contact signal and the NO contact signal. An LED indicates that the safety magnetic controller is in the "safe state".

To ensure fault detection of the switch-off device, the MÜZ-102 offers the possibility to connect a return circuit. The system additionally features a NC contact for signalling purposes.

- Redundancy by NO and NC contacts
- Manipulation safety by coding
- Monitoring of the return circuit (depending on device type)

Magnetic controllers for safety functions

TÜV certified

- EN ISO 13849-1 Performance Level d
- EN 61508 and EN 62061 SIL 3
- EN 60947-5-3 Single fault security S



Coded transducer units

Magnetic switches

Type designation	MÜZ-102/D24-FL-DA	MÜZ-202/D24-FL
Article number	6392701306	6392702307
Max. number of connectable transducer units	1	2
Safety output, NO contact	●	●
Feedback circuit	●	–
Data output (NC contact)	●	–
Technical data		
Operating voltage	24 V DC	24 V DC
Operating current	60 mA	60 mA

Type designation	
Article number	
Cable length	
Type designation	
Article number	
Cable length	

Type designation	
Article number	
Cable length	

Type designation	
Article number	
Cable length	

Type designation	
Article number	
Cable length	

Ambient conditions		
Temperature range	min/max	0 °C/+55 °C
		32 °F/+131 °F
Protection class (to IEC 529, EN 60529)		IP20
Enclosure material		PC
Mounting system (DIN 50022)		TS 35
Type of connection: Terminal block		max. 2.5 mm ²

Ambient conditions		
Temperature range	min/max	
Protection class (to IEC 529, EN 60529)		
Enclosure material		
Sensing distance	S on	min
	S on	max
Actuating magnet		
Type designation		
Article number		
Use: safety magnetic controller		
Article number		

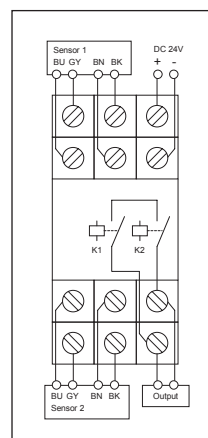
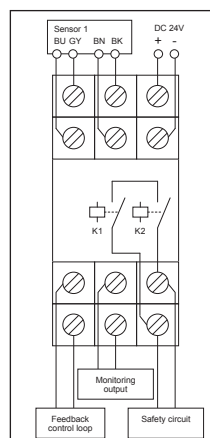
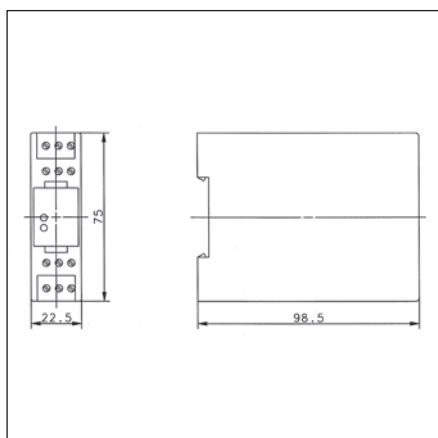

All dimensions in mm

Other types available on request.



MAK-4236-3 6490642315 3 m PVC cable	MAK-5236-3 6490652316 3 m PVC cable	MAK-5336-3 6490653317 3 m PVC cable
MAK-4236-6 6490642302 6 m PVC cable	MAK-5236-6 6490652307 6 m PVC cable	MAK-5336-6 6490653311 6 m PVC cable
MAK-4236-9 6490642303 9 m PVC cable	MAK-5236-9 6490652308 9 m PVC cable	MAK-5336-9 6490653312 9 m PVC cable
MAK-4236-STK 6490642305 4-pin connector	MAK-5236-STK 6490652309 4-pin connector	MAK-5336-STK 6490653313 4-pin connector

-5 °C/+70 °C +23 °F/+158 °F	-5 °C/+70 °C +23 °F/+158 °F	-5 °C/+70 °C +23 °F/+158 °F
IP67	IP67	IP67
PA 6.6	PBT	PA 6.6
4 mm	3 mm	3 mm
14 mm	14 mm	14 mm

TK-42-CD 6402042310	TK-52-CD/2 6402052311	TK-43-CD 6402043312
6392701306	6392701306	6392701306
6392702307	6392702307	6392702307

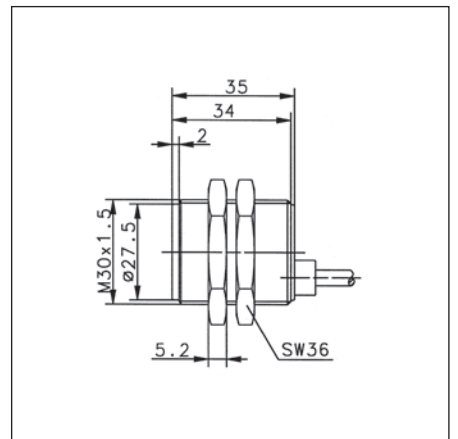
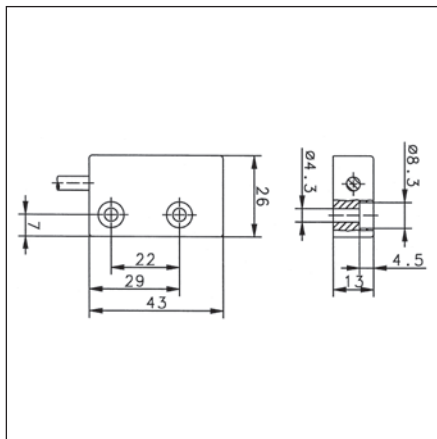
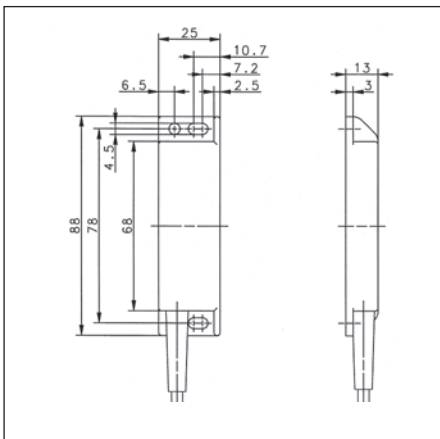

Accessories

Magnets

1. Hard ferrite magnets

Barium and strontium hard ferrites are economically priced, reliable components that are also widely used in automation, control and measurement applications. When operated in high temperature ranges, the specified switching distance will decrease by a factor of 0.2 % per 1 °C.

Chemical properties:

Ferrite magnets are oxide ceramics. They are made of approx. 80 % iron oxide and 20 % barium oxide or strontium oxide. The magnets are resistant to a large number of chemicals, including solvents, caustic solutions and weak acids. If strong organic and inorganic acids, e.g. hydrochloric, sulphuric and hydrofluoric acid, are used, their resistance will basically be determined by the temperature, concentration and reaction time of the medium. In general, the resistance should first be determined by means of longterm tests.

Mechanical properties:

Due to their ceramic characteristic, ferrites are brittle and sensitive to shock and bending loads.

2. Rare-earth magnets

Permanent magnets made from samarium cobalt and neodymium iron boron are high performance and high quality components that are widely used in drive and control engineering. When operated in high temperature ranges, the specified switching distance will decrease by a factor of 0.02 % per 1 °C.

Chemical properties:

All rare-earth magnets are metallic materials and show the corresponding characteristics associated with these materials, e.g. the polished shine immediately after being machined. The magnets are surface-treated (e.g. nickel coating) to protect them from environmental influences.

Mechanical properties:

Minor chips may occur if rare-earth magnets are subjected to impact stress. They respond very sensitively to vibrations and may become demagnetised.

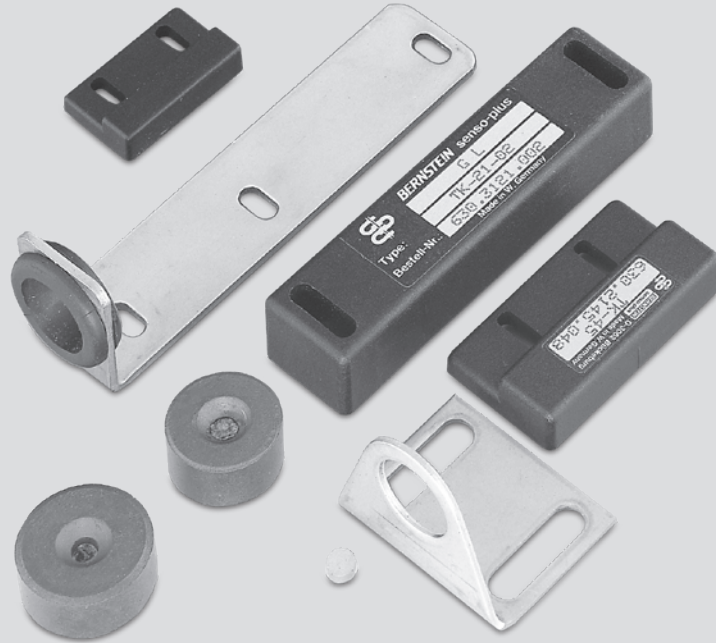

3. Plastic-bound magnets

Plastic-bound permanent magnets have an attractive price-performance ratio and thanks to the way they are formed they can be produced with complex geometries.

Injection-moulded magnets are typical composite materials. The magnetic powder is embedded in thermoplastic materials (polyamides). One of the main advantages of plastic-bound magnets is that they can be formed into a diverse range of shapes.

Chemical properties:

Surface corrosion can rarely be found on plastic bound magnets. For this reason, they can be used in most fields of application without additional coating.

Mechanical properties:

Plastic-bound magnets can be subjected to buckling and bending without breaking or chipping.

Use in potentially explosive atmospheres

Magnets must not be used in potentially explosive atmospheres as they can cause sparks. Grinding dust and chips from rare-earth magnets are self-igniting and burn off at high temperatures. They should therefore only be machined using ample water and never in dry conditions since even dried grinding dust can ignite.

Strong magnetic fields

Strong magnetic fields can interfere with or even damage electronic or mechanical equipment. This includes cardiac pacemakers. Appropriate safety distances are specified in the corresponding manuals or may be requested from the manufacturers.

Radioactive radiation

Permanent magnets must not be exposed to longterm radioactive radiation otherwise they may lose their magnetism.

Effects on persons

There are no known side-effects caused by touching magnet materials.

Magnet shapes

Rectangular, circular and cylindrical magnets are the most common shapes of permanent magnets manufactured in a press-shaping process. In addition to these standard geometries, permanent magnets may be manufactured in many other shapes. The shape should preferably be defined during the pressing process since subsequent shaping can only be performed using complex diamond tools. Holes and openings can only be made in the pressing direction.

Directions of magnetisation

The term preferred direction refers to the alignment of the magnetic crystals in a certain direction. The magnet achieves its highest magnetic values in this preferred direction and must therefore be magnetised in this direction.

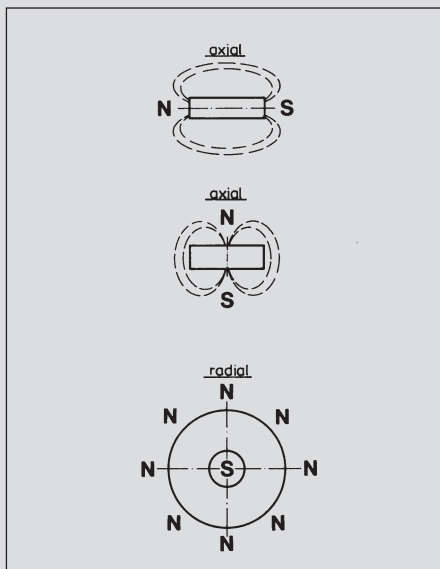

The preferred direction is achieved by subjecting the magnetic powder to a strong external magnetic field (coil) during the pressing process. As magnets have no preferred direction, the magnetisation direction and type can be freely selected.

Mounting a magnetic switch system on ferromagnetic materials





The nominal distance may be reduced when magnetic limit switches and their actuating magnets are mounted on magnetisable material (Fe, etc.). To ensure trouble-free operation, a minimum gap of 15 mm between the magnetic switch and any material that can be magnetised should be maintained as a reference value. The same applies to the actuating magnets.

Applications

- Counting
- Position indication in lifts
- End position switches in pneumatic and hydraulic installations
- Position indication on butterfly valves, slide valves and valves in general
- Conveyors in high-bay shelving
- Position detection in textile, packaging and meat cutting machines
- Machine runtime and downtime monitoring
- Control of machine tools
- Level monitoring of liquids (see Float Switches)

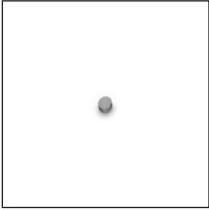
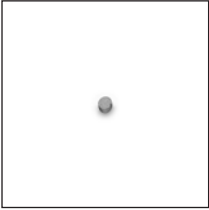
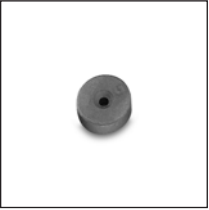
Accessories

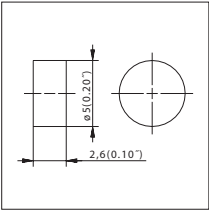
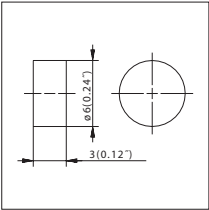
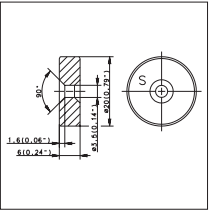
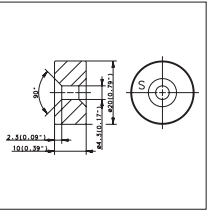
Actuating Magnets without Encapsulation

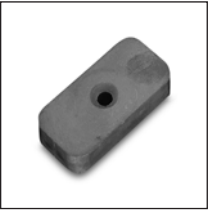
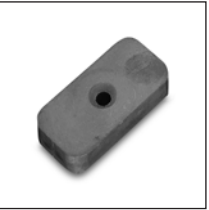
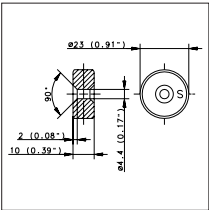
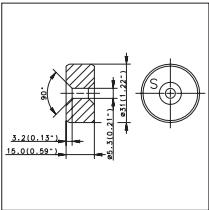
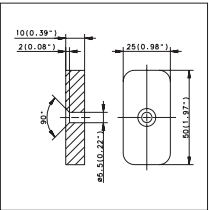
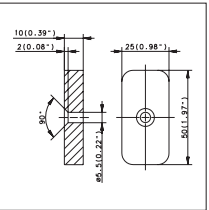





Actuating magnets without encapsulation	T-75	T-06N/S	T-61N/S	T-67N/S
				
Magnet material	Rare-earth	Neodymium iron boron (NdFeB)	Barium ferrite	Barium ferrite
Temperature range (magnetic switch operation)	-40 °C ... +150 °C -40 °F ... +302 °F	-40 °C ... +150 °C -40 °F ... +302 °F	-40 °C ... +150 °C -40 °F ... +302 °F	-40 °C ... +150 °C -40 °F ... +302 °F
Temperature coefficient	0.2 %/K	0.2 %/K	0.2 %/K	0.2 %/K
Enclosure material	-	-	-	-
Article number	6301175057	6301106065	6301261035	6301167054
Dimensioned drawing				
		Marking slots on north pole side		
Actuating magnets without encapsulation	T-62N/S	T-69N/S	T-68N	T-68S
				
Magnet material	Barium ferrite	Barium ferrite	Barium ferrite	Barium ferrite
Temperature range (magnetic switch operation)	-40 °C ... +150 °C -40 °F ... +302 °F	-40 °C ... +150 °C -40 °F ... +302 °F	-40 °C ... +150 °C -40 °F ... +302 °F	-40 °C ... +150 °C -40 °F ... +302 °F
Temperature coefficient	0.2 %/K	0.2 %/K	0.2 %/K	0.2 %/K
Enclosure material	-	-	-	-
Article number	6301262039	6301269031	6301268028	6301368033
Dimensioned drawing				
			90° countersink on north pole side	90° countersink on south pole side

Actuating Magnets in Plastic Enclosure

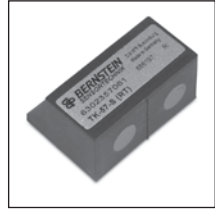
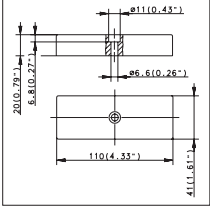
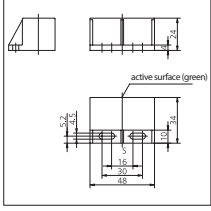
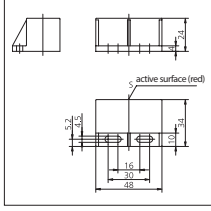

Actuating magnets in plastic enclosure	TK-11-11	TK-11-01	TK-21-02	TK-21-12
Magnet material	AlNiCo-500	AlNiCo-500	AlNiCo-500	AlNiCo-500
Temperature range (magnetic switch operation)	-20 °C ... +80 °C -4 °F ... +176 °F	-20 °C ... +80 °C -4 °F ... +176 °F	-20 °C ... +80 °C -4 °F ... +176 °F	-20 °C ... +80 °C -4 °F ... +176 °F
Temperature coefficient	0.2 %/K	0.2 %/K	0.2 %/K	0.2 %/K
Enclosure material	PA 6.6	PA 6.6	PA 6.6	PA 6.6
Article number	6302111047	6303111001	6303121002	6302121030
Dimensioned drawing				
Actuating magnets in plastic enclosure	TK-45	TK-42	TK-44	
Magnet material	AlNiCo-500	AlNiCo-500	AlNiCo-500	
Temperature range (magnetic switch operation)	-20 °C ... +80 °C -4 °F ... +176 °F	-20 °C ... +80 °C -4 °F ... +176 °F	-20 °C ... +80 °C -4 °F ... +176 °F	
Temperature coefficient	0.2 %/K	0.2 %/K	0.2 %/K	
Enclosure material	PA 6.6	PA 6.6	PA 6.6	
Article number	6302145048	6302142049	6302144050	
Dimensioned drawing				

Accessories

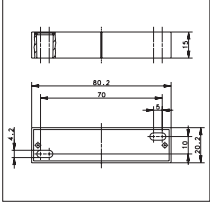
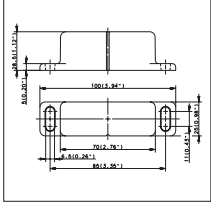
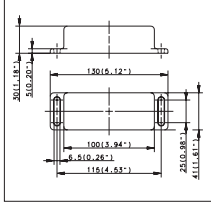
Actuating Magnets



Actuating magnets in plastic enclosure	TK-50	TK-57N	TK-57S
			
Magnet material	Barium ferrite	Barium ferrite	Barium ferrite
Temperature range (magnetic switch operation)	-20 °C ... +80 °C -4 °F ... +176 °F	-20 °C ... +80 °C -4 °F ... +176 °F	-20 °C ... +80 °C -4 °F ... +176 °F
Temperature coefficient	0.2 %/K	0.2 %/K	0.2 %/K
Enclosure material	PA 6.6	PBT	PBT
Article number	6302100053	6302257060	6302357061
Dimensioned drawing			
Actuating magnets in metal enclosure	TA-21-02	TA-31	TA-33
			
Magnet material	AlNiCo-500	AlNiCo-500	Barium ferrite
Temperature range (magnetic switch operation)	-40 °C ... +150 °C -40 °F ... +302 °F	-20 °C ... +80 °C -4 °F ... +176 °F	-20 °C ... +80 °C -4 °F ... +176 °F
Temperature coefficient	0.2 %/K	0.2 %/K	0.2 %/K
Enclosure material	Al	Al	Al
Article number	6305121064	6303131005	6303133034
Dimensioned drawing			

Mounting Brackets



Mounting brackets	BWN-M06NI/40 x 47	BWN-M06NI/27 x 38	BWN-M36NI
			
Material	Niro 1.4301	Niro 1.4301	Niro 1.4301
For series	MA-06, MA-16, MA-26, MA-15	MA-06, MA-16, MA-26, MA-15	MA-06, MA-16, MA-26, MA-15
Article number	4102802001	4102802002	4904700035
Dimensioned drawing			





Accessories

Miniature Snap-In Connectors

Miniature snap-in connectors		Ø 6.5 mm	Ø 6.5 mm
Contact assignments 1 = Brown 2 = Black 3 = Blue			
			
Cable material		PUR	PUR
Coupler material		PA 12	PA 12
Coupling ring material		POM	POM
Temperature range		-25 °C ... +90 °C -13 °F ... +194 °F	-25 °C ... +90 °C -13 °F ... +194 °F
Switching function		Universal	Universal
Cable structure		3 x 0.25 mm ²	3 x 0.25 mm ²
Protection class		IP67/NEMA 4	IP67/NEMA 4
Article number	2,5 m	4139100219	4139100221
Type		GDK-R06US/SO0-2,5PU	WDK-R06US/SO0-2,5PU
Article number	5 m	4139100220	4139100222
Type		GDK-R06US/SO0-5PU	WDK-R06US/SO0-5PU
Article number	10 m		4139100267
Type			WDK-R06US/SO0-10PU

Connectors

Cable connector M8 x 1	M8	M8	M8
Contact assignments 1 = Brown 2 = Black 3 = Blue			
Cable material	PVC	PVC	PVC
Coupler material	TPU	PUR	PUR
Coupling ring material	CuZn39Pb3	CuZn39Pb3	CuZn39Pb3
Temperature range	-25/+90 °C	-25/+90 °C	-25/+90 °C
Switching function	PNP/LED	Universal	Universal
Cable structure	3 x 0.25 mm ²	3 x 0.25 mm ²	3 x 0.25 mm ²
Protection class	IP67	IP67	IP67
Article number	2 m	4139100795	4139100798
Type		WDK-M08PS/LL2-2	WDK-M08US/WO0-2
Article number	5 m	4139100216	4139100799
Type		WDK-M08PS/LL2-5	WDK-M08US/WO0-5
Article number	10 m		4139100800
Type			WDK-M08US/WO0-10

Cable connector M12 x 1	M12 3-wire	M12 3-wire	M12 4-wire	M12 4-wire
Contact assignments 1 = Brown 2 = White 3 = Blue 4 = Black				
Cable material	PVC	PVC	PVC	PUR
Coupler material	PUR	PUR	PA	PUR
Coupling ring material	CuZn39Pb3	CuZn39Pb3	CuZn39Pb3	CuZn39Pb3
Temperature range	-25/+90 °C	-25/+90 °C	-25/+90 °C	-25/+90 °C
Switching function	Universal	Universal	Universal	PNP/LED
Cable structure	3 x 0.34 mm ²	3 x 0.34 mm ²	4 x 0.25 mm ²	4 x 0.25 mm ²
Protection class	IP67	IP67	IP67	IP67
Article number	4139100801	4139100804		4139100244
Type	GDK-M12US/WO0-2	WDK-M12US/WO0-2		WDK-M12PA/SL2-2PU
5 m	4139100802	4139100468	4139100903	4139100245
Type	GDK-M12US/WO0-5	WDK-M12US/WO0-5	WDK-M12UA/WO0-5	WDK-M12PA/SL2-5PU
10 m	4139100803	4139100805	4139100467	4139100254
Type	GDK-M12US/WO0-10	WDK-M12US/WO0-10	WDK-M12UA/WO0-10	WDK-M12PA/SL2-10PU

Cable connector M12 x 1	M12	M12	M12 3-wire	M12 5-wire
Contact assignments 1 = Brown 2 = White 3 = Blue 4 = Black				
Cable material	-	-	PVC	PUR
Coupler material	PA	PA	TPU	PUR
Coupling ring material	CuZn39Pb3	CuZn39Pb3	CuZn39Pb3	CuZn39Pb3
Temperature range	-25/+90 °C	-25/+90 °C	-25/+90 °C	-25/+90 °C
Switching function	Universal	Universal	PNP/LED	Universal
Cable structure	-	-	3 x 0.4 mm ²	5 x 0.34 mm ²
Protection class	IP67	IP67	IP67	IP67
Article number	4139100102	4139100101	4139100553	4139100956
Type	GDA-M12UA/LO	WDA-M12UA/LO	WDK-M12PS/LL2-2	GDK-M12UU/HO-2PU
5 m			4139100554	
Type			WDK-M12PS/LL2-6	
10 m				
Type				

Accessories

Mounting Material

Other mounting brackets available on request.

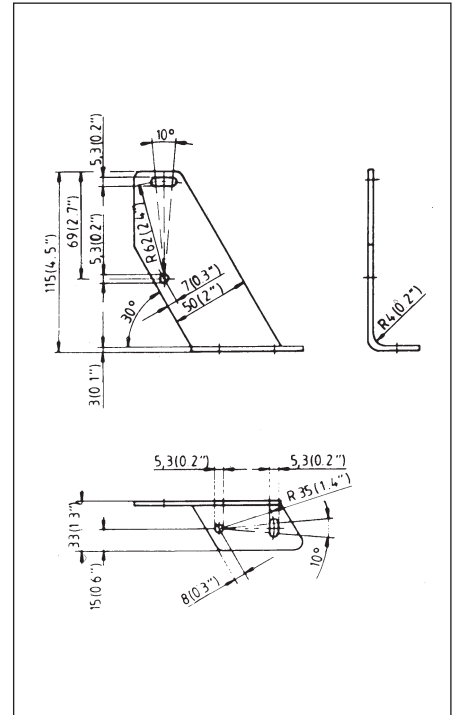
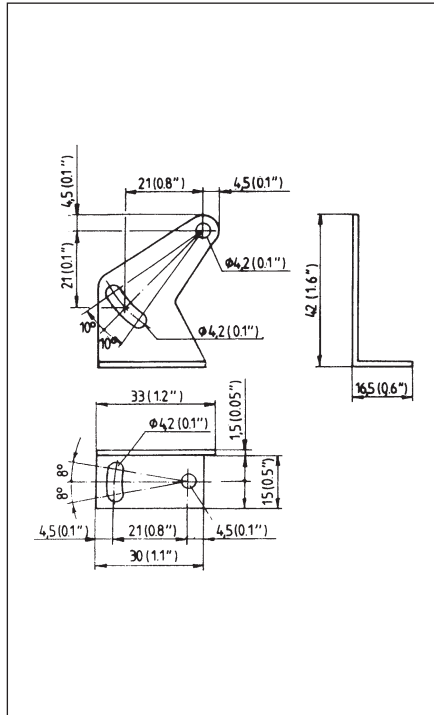

Type designation	BWN-L05ST KPL	BWN-L20NI KPL
Article number	6571300003	6571200002

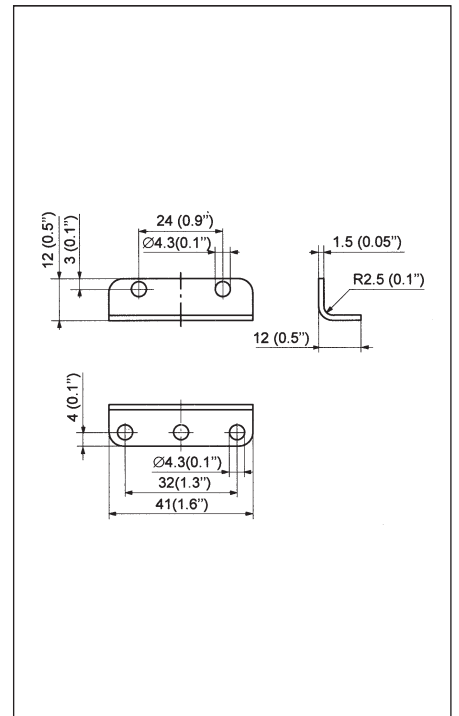
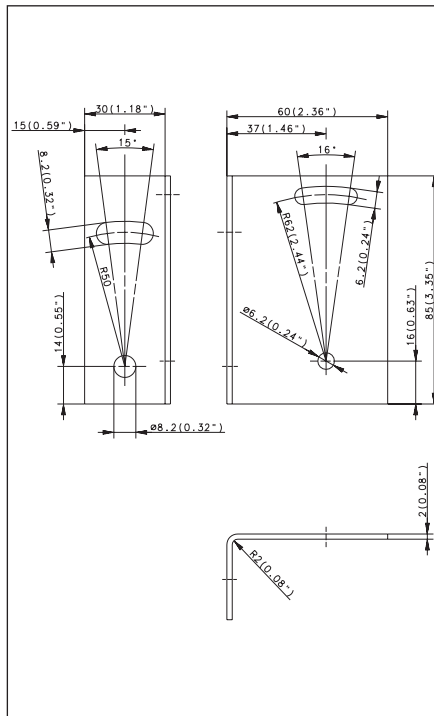

Type designation	BWN-L20NI KPL	BWN-L12AL KPL
Article number	6571200007	6571500006

Accessories

Sensor Tester



Technical data	
Type designation	Sensor Tester
Article number	6510000048
Function	Sensor tester for DC 2-wire and 3-wire proximity switches Test function: Checking and indicating the switching status of a sensor with visual and acoustic signal
Power supply	9 V block battery (6LR61)
Output voltage	15 VDC, 20 mA stabilised
Enclosure	Modified enclosure of Series OR20
Temperature range	-25 °C/+70 °C
Input signals	NPN/PNP 3-wire, DC 2-wire, NAMUR

The sensor tester is used for checking 2-wire and 3-wire DC proximity switches. Coloured LEDs and an acoustic signal are used to indicate the switching statuses.

- Green LED: Operating voltage
- Red LED: Low battery
- Yellow LED: Sensor switching status

When not in use, the sensor tester switches off automatically after approx. 30 s.

Connection assignments

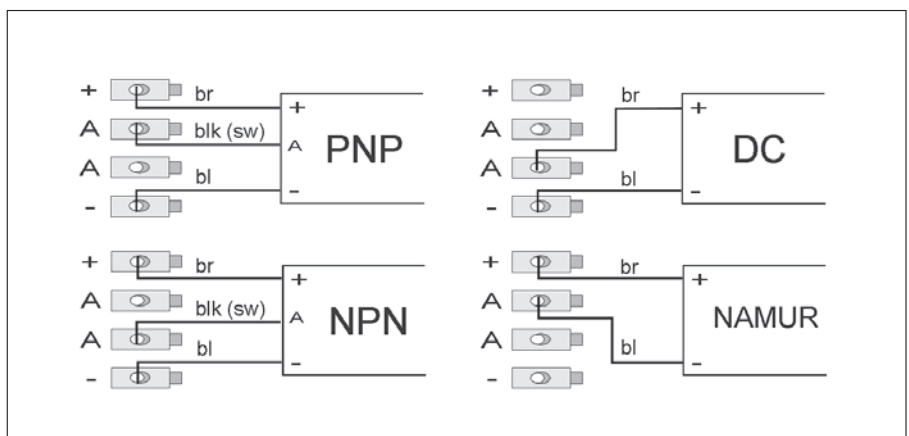

Type Code

Inductive Sensors

1	2	3	4	5	6	7	8	9	10	11	12	13	14	15	16	17	18	19	+
K	I	N	-	T	1	2	N	S	/	0	0	4	-	K	L	2			
Product group			Type of enclosure				Output		Sensing distance				Options						

Product group		
1	K	Non-contact proximity switch
2	I	Inductive
3	B	Flush mount
	N	Non-flush mount
	R	Ring sensor
4	-	Dash (fixed)
Type of enclosure		
5	M	Metric thread (metal enclosure)
	T	Metric thread (plastic enclosure)
	D	Round enclosure (metal)
	R	Round enclosure (plastic)
	Q	Cuboid enclosure (metal)
	P	PG thread (metal)
	E	Rectangular enclosure (plastic)
	S	Slot proximity switch (plastic)
	N	Standard mounting (to DIN 50025/50037)
	C	Compact enclosure
6 – 7		Two-digit number for:
		Round types = Ø as specified
		Threaded types = standard designation
		Rectangular types = consecutive type numbers

Design examples		
	D08	Ø 8 mm (metal)
	R22	Ø 22 mm (plastic)
	M12	Threaded barrel M12 x 1
Rectangular and other types		
	E16	16 x 5 x 5 mm
	E27	27 x 10 x 5.5 mm
	E28	28 x 16 x 11 mm
	E40	40 x 26 x 12 mm
	E50	50 x 25 x 10 mm
	E68	68 x 30 x 15 mm
	G00	Tube thread, general
	N44	41.5 x 41.5 x 120 mm
	Q05	5 x 5 x 25 mm
	Q08	8 x 8 x 40 mm, Side active
	Q12	12 x 12 x 55 mm

Output		
8	P	PNP
	N	NPN
	A	AC 2-wire
	E	NAMUR
	Z	DC 2-wire
	R	Relay
	G	Push-pull
	D	Dual output stage (NPN/PNP selectable)
9	S	NO contact
	Ö	NC contact
	P	Programmable
	A	Analogue
	U	Antivalent (selectable)
10	/	Slash (fixed)
Sensing distance		
11 – 13	f. ex. 1.5	1.5 mm
	f. ex. 002	2.0 mm
	f. ex. 040	40 mm
14	-	Dash (fixed)
Options		
15 – 17		See type code "OPTIONS", p. 106

Capacitive Sensors

1	2	3	4	5	6	7	8	9	10	11	12	13	14	15	16	17	18	19	+
K	C	N	-	T	1	2	N	S	/	0	0	4	-	K	L	P	2		
Product group			Type of enclosure				Output		Sensing distance				Options						

Product group		
1	K	Non-contact proximity switch
2	C	Capacitive
3	B	Flush mount
	N	Non-flush mount
4	-	Dash (fixed)
Type of enclosure		
5	M	Metric thread (metal enclosure)
	T	Metric thread (plastic enclosure)
	D	Round enclosure (metal)
	R	Round enclosure (plastic)
	Q	Cuboid enclosure (metal)
	P	PG thread (metal)
	E	Rectangular enclosure (plastic)
	N	Standard mounting (to DIN 50025/50037)
6-7		Two-digit number for:
		Round types = Ø as specified
		Threaded types = standard designation
		Rectangular types = consecutive type numbers

Design examples		
	12	Thread M12 x 1
	18	Thread M18 x 1
	30	Thread M30 x 1,5
	32	Thread M32 x 1,5
	34	Ø 34 mm (metal/plastic)
	20	Ø 20 mm (plastic)
	22	Ø 22 mm (plastic)
	50	50 x 25 x 10 mm
	68	68 x 30 x 15 mm
	44	41.5 x 41.5 x 120 mm (Euro standard enclosure)
Output		
8	p	PNP
	N	NPN
	A	AC 2-wire
	E	NAMUR
	Z	DC 2-wire
	R	Relay
	G	Push-pull
	D	Dual output stage (NPN/PNP selectable)

Output		
9	S	NO contact
	Ö	NC contact
	P	Programmable
	A	Analogue
	U	Antivalent (selectable)
10	/	Slash (fixed)
Sensing distance		
11-13	e.g. 1.5	1.5 mm
	e.g. 002	2.0 mm
	e.g. 040	40 mm
14	-	Dash (fixed)
Options		
15-19		See type code "OPTIONS", p. 106

Magnetic Switches

1	2	3	4	5	6	7	8	9	10	11	12	13	14	15	16	17		
M	A	K	-	0	1	1	2	-	D	-	1	-	S	O	K			
Product group			Type			Contact specifications				Cable length			Special features					

Product group		
1	M	Magnetic switch
2	Type of output	
	A	Reed contact
	R	Relay
3	Enclosure material	
	A	Aluminium
	N	Stainless steel
	M	Brass, nickel-plated
	K	Plastic, general
	O	Other materials
4	-	Dash (fixed)
Type		
5 – 6	01 – 99	Cylindrical and rectangular types (see next page for details)
Contact specifications		
7	Number of contacts	
	e.g. 1	1 Reed contact
	e.g. 2	2 Reed contacts
	...	etc.

8	Contact function	
	1	NC contact
	2	NO contact
	3	Changeover contact
	4	Bistable (ON/OFF)
	5	Bistable (changeover contact)
	6	NC, NO contact; separate contacts
	7	Coded, BG
	8	Currently not used
	9	Currently not used
	0	Other outputs
9	-	Dash (fixed)
10	Contact type/power of reed contacts	
	A	250 VDC ; 0.5 A; 20 VA
	B	250 VDC ; 0.5 A; 10 VA
	C	250 VDC ; 0.5 A; 30 VA
	D	250 VDC ; 0.5 A; 30 VA
	E	250 VDC ; 1.5 A; 30 VA
	F	250 VDC ; 3.0 A; 100 VA
	G	250 VDC ; 5.0 A; 250 VA
	H	250 VDC ; 1.0 A; 60 VA
	K	250 VDC ; 0.5 A; 30 VA
	L	250 VDC ; 1.0 A; 60 VA
	M	250 VDC ; 1.0 A; 80 VA
	N	250 VDC ; 1.0 A; 60 VA
	O	120 VDC ; 0.5 A; 10 VA
	P	250 VDC ; 5.0 A; 250 VA
	R	28 VDC ; 0.25 A; 3 VA
	W	250 VDC ; 1.0 A; 60 VA
	X	100 VDC ; 0.25 A; 5 VA
	Y	100 VDC ; 0.5 A; 10 VA

TRIAC		
	K	24 – 250 VDC ; 1.5 A a. 300 VA b. 330 VA
	Hall	
11	-	Dash (fixed)
Cable length in metres		
12	e.g. 1	1 m cable
	e.g. 2	2 m cable
	...	etc.
13	-	Dash (fixed)
Special features		
14 – 17	T	Temperature resistant from -40 °C to +150 °C
	SI	With miniature fuse
	VDR	With VDR
	WID	With resistor
	LED	With LED
	SPK	Spiral cable
	SK	Special cable
	SOK	Connector type without head (without device socket)
	SMK	Connector type with head (with device socket)
	PG11	Type of thread
	RZ	Time delay with relay
	220 V	220 Volt version
	24 V	24 Volt version
	STK	Connector

Magnetic Switches

1	2	3	4	5	6	7	8	9	10	11	12	13	14	15	16	17		
M	A	K	-	0	1	1	2	-	D	-	1	-	S	O	K			
Product group			Type			Contact specifications				Cable length			Special features					

Type		
5 – 6	01 – 99	Cylindrical and rectangular types
	01	45 x 13 x 9 mm [MA-01] PA
	02	80 x 20 x 15 mm [MA-02] PA/AL
	03	110 x 58 x 29 mm [MA-03] AL
	04	∅ 15.5 x 87 mm [MA-04] PC
	05	Currently not used
	06	∅ 12 x 81 mm [MA-06] AL
	07 – 10	Currently not used
	11	28.6 x 18 x 6.4 mm [MA-11] PA
	12	80 x 20 x 15 mm [MA-12] PA
	13	68 x 30 x 15 mm [MA-13] PC
	14	Currently not used
	15	∅ 12 x 81 mm [MA-15] PA
	16	∅ 12 x 81 mm [MA-13] VA
	17	PG9 x 60 mm [MA-17] PA
	18	M12 x 1 x 60 mm [MA-18] Ms
	19	M18 x 1 x 80 mm [MA-19] Ms
	20	Currently not used
	21	PG9 x 80 mm [MA-21] PA
	22	Currently not used
	23	M12 x 1 x 80 mm [MA-23] Ms
	24/25	Currently not used
	26	∅ 12 x 81 mm [MA-26] PA
	27	Currently not used
	28	M12 x 1 x 60 mm [MA-28] PA
	29	M18 x 1 x 80 mm [MA-29] PA
	30	∅ 6 x 30 mm [MA-30] PA
	31	Currently not used
	32	85 x 26 x 26 mm [MA-32] PBT
	33	M12 x 1 x 80 mm [MA-33] PA
	34/35	Currently not used

	36	∅ 13 x 96 mm [MA-36] PA
	37–39	Currently not used
	40	M10 x 1 x 40 mm [MA-40] PPE
	41	50 x 31 x 11 mm [MA-41] PA
	42	88 x 25 x 13 mm [MA-42] PA
	43	PG9 x 80 mm [MA-43] Ms
	44	80 x 30 x 15 mm [MA-44] PA
	45	45 x 25.5 x 9 mm [MA-45] PA
	46	∅ 6.5 x 39.34 mm [MA-46] PA
	47	Currently not used
	48	80 x 30 x 15 mm [MA-48] PA
	49–51	Currently not used
	52	43 x 26 x 13 mm [MA-52] PBT
	53	M30 x 1.5 mm [MA-53] PA
	54	Currently not used
	55	12 x 12 x 55 mm [MA-55] S
	56–59	Currently not used
	60	M8 x 1 mm [MA-60] S
	61	M10 x 1 mm [MA-61] S
	62	M12 x 1 mm [MA-62] S
	63	M18 x 1 mm [MA-63] S
	64	M30 x 1.5 mm [MA-64] S
	65–69	Currently not used
	70	∅ 6.5 mm [MA-70] S
	71/72	Currently not used
	73	68 x 30 x 15 mm [MA-73] S
	74–79	Currently not used
	80	8 x 8 x 40 mm [MA-80] S
	81–98	Currently not used
	99	other [MA-99] S

Magnetic Switch Monitoring Devices

1	2	3	4	5	6	7	8	9	10	11	12	13	14	15	16	17	18	19	20	21	22	23	24
M	Ü	Z	-	1	0	2	/	U	2	4	-	F	L	-	2	S	-	E	2	0	-	H	G
Product group				Numb. of magnetic switches	Number of relays				Voltage				Special features										

Product group		
1	M	Magnetic limit switch, general
2	Ü	Monitoring
	C	Controller
3	Z	Control station
	S	Interface
	N	Power supply unit
4	-	Dash (fixed)
Number of connectable magnetic switches		
5	1	1 unit
	2	2 units
	...	etc.
Number of relays		
6 – 7	01	1 unit
	02	2 units
	03	Constant current source
	04	4 units
	...	etc.
8	/	Slash (fixed)

Voltage		
9	A	AC
	D	DC
	U	UC
	1	Mains voltage
	2	Mains voltage
10 – 11	24	24 Volt
	The following applies when there is a "1" in the 9 th position:	
	10	110 Volt
	20	120 Volt
	30	130 Volt
	The following applies when there is a "2" in the 9 th position:	
	10	210 Volt
	20	220 Volt
	30	230 Volt

Special features		
13 – 24	FL	Flat design
	2S	NO contact signal (to outside)
	E20	20 transducer units, externally
	HG	Hall sensor
	VC	Voltage control
	PRT	Print version
	DA	Data output
	Special features are separated by a dash with no specific position assignment.	

Magnetic Sensors / Teachable Slot Sensors / Electronic

1	2	3	4	5	6	7	8	9	10	11	12	13	14	15						
M	E	K	-	M	1	2	P	S	/	H	1	0	-	K	L	2				
Product group			Type of enclosure				Output		Sensitivity				Options							

Product group		
1	M	Magnetic sensor
2	E	Electronic
3	K	Plastic
	M	Brass
	N	Stainless steel
4	-	Dash (fixed)
Type of enclosure		
5	M	Metric thread
	D	Round enclosure
	E	Rectangular enclosure
	Q	Cuboid enclosure
6 – 7		Two-digit number for:
		Metric enclosure = standard designation
		Round enclosure = Ø as specified
		Rectangular enclosure = enclosure width
		Cuboid enclosure = edge length

Output		
8	P	PNP
	N	NPN
9	S	NO contact
	Ö	NC contact
	B	Bistable
	A	Analogue
	D	Speed
10	/	Slash (fixed)
Sensitivity		
11	H	Hall
	M	Magneto-resistive
12 – 13		Sensitivity in mT
	z. B. 10	10 mT
	z. B. 01	1 mT
14	-	Dash (fixed)
Options		
15		See type code "OPTIONS", see page 106

Type Code

Options

1	2	3	4	5	6	7	8	9	10	11	12	13	14				
K	L	2	E	V	P	S	N	T	F	Z	I	D	G				

1	K	Short circuit-proof
2	L	LED
3	2	Cable length in m
4	E	Extended sensing distance (sn large)
5	V	Shortened type
6	P	Potentiometer
7	S	Device connector (terminals)
	PU	PUR cable
	SD	Connector to DIN 43650 (including socket)
	SM	Mini snap-in device connector
	S8	M8 device connector with union nut
	S12	M12 device connector with union nut
	SM8	Mini snap-in / M8 screw-on device connector
	S12A	M12 device connector with union nut, AC version
	S16S	M16 device connector with union nut and dust cap
	S12U	M12 Ultra-Lock device connector
	S5	M5 x 0,5 device connector Screw-connection with cable

8	N	Stainless steel enclosure
9	T	Extended temperature range
10	F	Extended switching frequency
11	Z	Time-delayed
12	I	Programmable (intelligent)
13	D	ATEX products, dust Ex
14	G	ATEX products, gas Ex

Cable Connectors

1	2	3	4	5	6	7	8	9	10	11	12	13	14	15	16	17			
W	D	K	-	M	1	2	P	S	/	L	L	2	-	2	P	U			
Device specifications			Type of connection				Classification			LEDs			Cable length	Options					

Device specifications		
1		Cable output
	W	Elbow
	G	Straight
2		Product group
	D	Socket
	S	Connector (the sensor connections should always be used as the basis for connecting lines with different outputs)
	A	Adapter (socket and connector)
3		Preassembly
	K	Fixed cable
	A	Connection space, self-configurable
	V	Connecting line (extension)
4	-	Dash (fixed)
Type of connection		
5 - 7		Always related to the socket / connector
	M12	Union nut M12 x 1
	M08	Union nut M8 x 1
	R06	Round snap-in connection Ø 6.5 mm
	R12	Round snap-in connection, Ultra-Lock M12
	M05	M5 x 0.5 screw-on connection

Classification		
8		Configuration for switch output
	P	PNP (LED to negative)
	N	N = NPN (LED to positive)
	U	Universal (no LED)
	A	AC (M12 special coding Pin 1 + 2)
9		Pin assignments of cable sockets for switch output
	S	NO contact 1 - 3 - 4 for M12 1 - 3 - 2 for Mini 1 - 2 for M12 AC
	Ö	NC contact 1 - 3 - 2 for M12
	A	Antivalent 1 - 3 - 4 - 2 for M12
	N	NAMUR 1 - 3 for M12
	U	More than 4 connections
	T	Teach-in function
10	/	Slash (fixed)
Manufacturer		
11		Internal information

LEDs		
12	L	Integrated LED
	O	Without LED
13		Number of LEDs
	0	No LED
	1	1 LED
	2	2 LEDs etc.
14	-	Dash (fixed)
Cable length		
15		In m (moulded cable)
Options		
16 - 17	PU	Polyurethane cable
	HF	Highly flexible cable
	SD	Connector/socket
	BD	Socket both ends
	R	Vibration safeguard
	Without	PVC cable

Type Code

Mounting Material

1	2	3	4	5	6	7	8	9											
B	K	S	-	D	2	0	P	A											
Product group				Type group			Material												

Product group		
1	B	Mounting material
2		Type of product
	K	Retaining bracket
	W	Mounting bracket
	H	Retaining plate
3		Specification
	S	Bracket, 2-piece
	B	Block, 1-piece
	R	Reducer
	N	90° elbow
4	-	Dash (fixed)

Type group		
5-7		For clips:
		Diameter in mm corresponding to matching sensor
		For elbows: Type group
	e.g. L05	Light barrier OR05
	e.g. M06	Magnetic switch M06
Material		
8-9		Material
	ST	Steel
	NI	Stainless steel
	AL	Aluminium
	PA	Polyamide
	PP	Polypropylene

Types of Output DC 1

Cable colour abbreviations

BN = Brown

BU = Blue

BK = Black (switch output)

PNP output (circuit schematic)

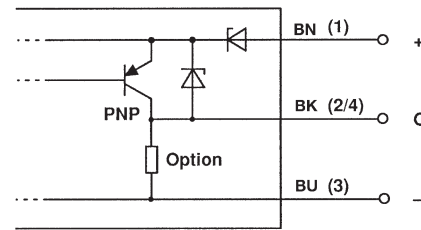

NPN output (circuit schematic)

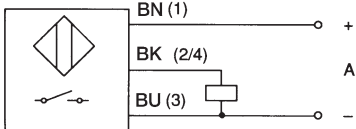
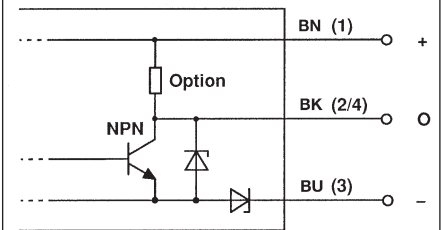

1) PNP normally-open contact

When actuated, a PNP transistor applies the output to positive.

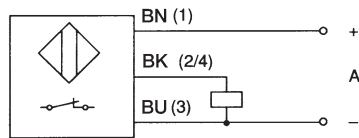

2) PNP normally-closed contact

When actuated, a PNP transistor disconnects the output from positive.

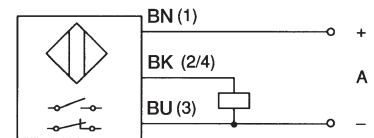

3) PNP programmable

The PNP NO contact 1) or PNP NC contact 2) function can be selected by means of a built-in changeover switch.

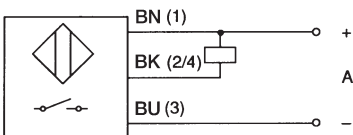

4) NPN normally-open contact

When actuated, a NPN transistor applies the output to negative.

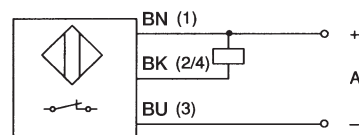

5) NPN normally-closed contact

When actuated, an NPN transistor disconnects the output from negative.

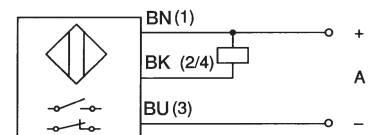

6) NPN programmable

The NPN NO contact 4) or NPN NC contact 5) function can be selected by means of a built-in changeover switch.

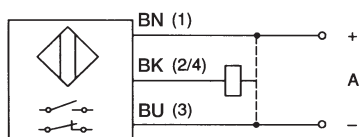

7) PNP/NPN programmable

Two built-in changeover switches are used to select between PNP or NPN switching and between NC or NO function.

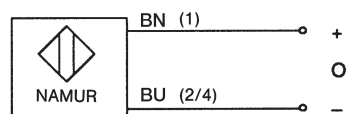

8) NAMUR

Current change to DIN EN 60947-5-6

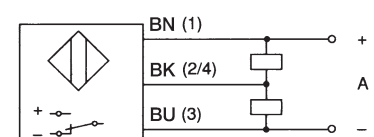

9) Push-pull programmable

When actuated, the output changes from negative to positive or, selectable with a built-in changeover switch, from positive to negative.

Wiring Diagrams

Types of Output DC 2

Cable colour abbreviations

- BN = Brown
- BU = Blue
- BK = Black (switch output)
- WH = White (switch output)

DC 2-wire
(circuit schematic)

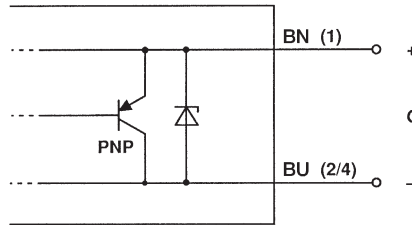

DC 4-wire
(circuit schematic)

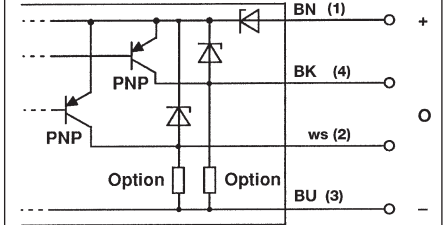

1) NO contact DC 2-wire
When actuated, the contacts are bridged.

2) NC contact DC 2-wire
When actuated, the contacts are disconnected.

3) NC/NO contact programmable DC 2-wire
The NO contact 1) or NC contact 2) function can be selected by means of a built-in changeover switch.

4) Changeover output DC (antivalent) PNP 4-wire
When actuated, the positive operating voltage is alternatively applied to one of the two outputs.

5) Changeover output DC (antivalent) NPN 4-wire
When actuated, the negative operating voltage is alternatively applied to one of the two outputs.

Types of Output AC 1

Cable colour abbreviations

BN = Brown
 BU = Blue
 BK = Black

AC 2-wire
 (circuit schematic)

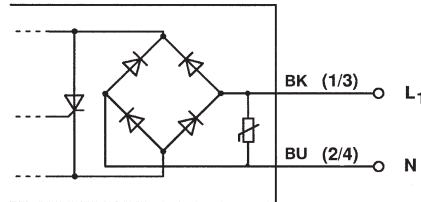

AC 3-wire
 (circuit schematic)

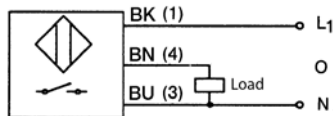
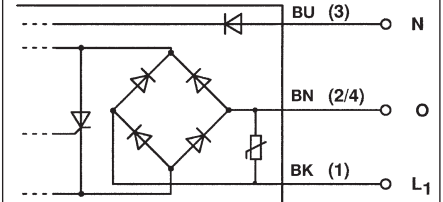

1) NO contact AC 3-wire

When actuated, a thyristor connected across a rectifier bridge applies the operating voltage to the output.

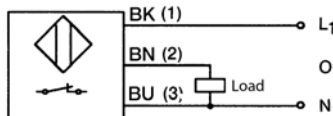

2) NC contact AC 3-wire

When actuated, a thyristor connected across a rectifier bridge disconnects the operating voltage from the output.

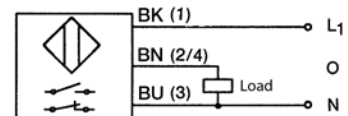

3) NC/NO contact programmable AC 3-wire

The AC NO contact 1) or AC NC contact 2) function can be selected by means of a built-in changeover switch.

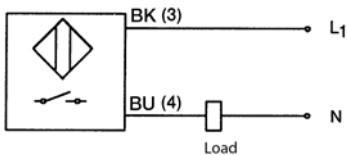

4) NO contact AC 2-wire

When actuated, a thyristor connected across a rectifier bridge applies the load to the operating voltage.

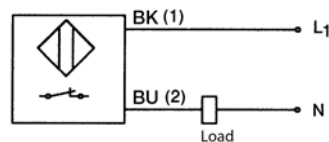

5) NC contact AC 2-wire

When actuated, a thyristor connected across a rectifier bridge disconnects the load from the operating voltage.

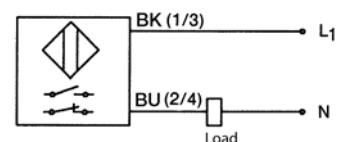

6) NC/NO contact programmable AC 2-wire

The AC NO contact 4) or AC NC contact 5) function can be selected by means of a built-in changeover switch.

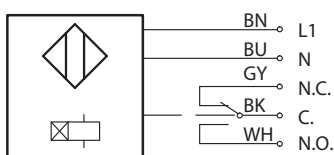

7) AC relay output

With adjustable pickup delay

Wiring Diagrams







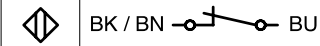

Type of Contact

Electric Loading Capacity of Reed Contacts AC/DC

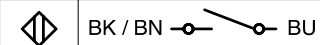
Contact type ID	Power	Voltage	Current
R	3 VA	28 V	0.25 A
X	5 VA	100 V	0.25 A
B	10 VA	250 V	0.5 A
Y	10 VA	100 V	0.5 A
A	20 VA	250 V	0.5 A
K	30 VA	250 V	0.5 A
H	60 VA	250 V	1.0 A
L	60 VA	250 V	1.0 A
M	80 VA	250 V	1.0 A
F	100 VA	250 V	3.0 A
G	250 VA*	250 V	5.0 A*
P	250 VA*	250 V	5.0 A*

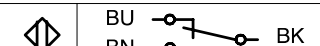
* Maximum make current for the duration of 2 ms
2.5 A; 100 W/VA in continuous operation

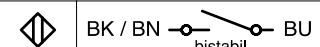
Wiring Diagrams Electromechanical Magnetic Switches

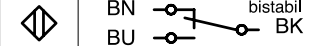
contact		
NO contact		
Changeover contact		
Bistable ON-OFF		
Bistable Changeover contact		

Wiring Diagrams Electronic Magnetic Switches

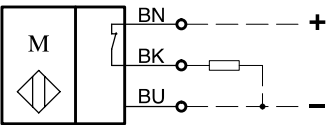
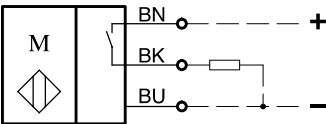
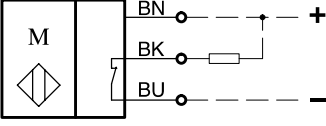
NC contact, PNP	
NO contact, PNP/PNP, bistable	
NC contact, NPN	
NO contact, NPN	