

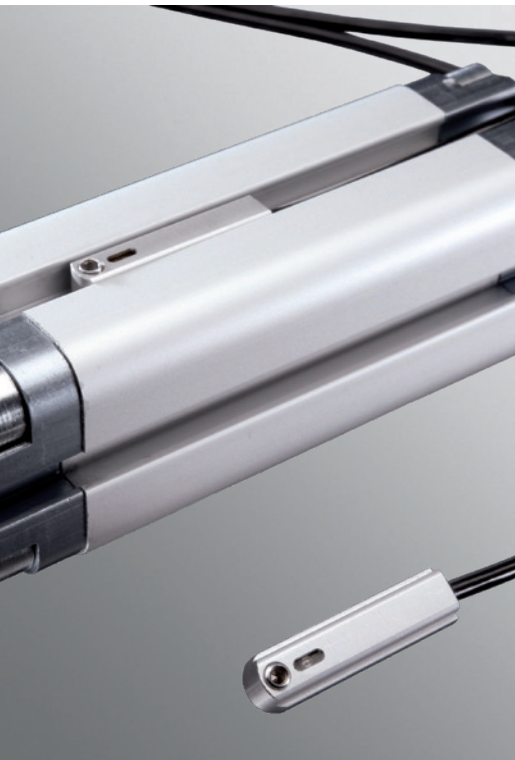

**Complete Range  
Sensor Systems**





# BERNSTEIN AG

## A Success Story



### Safety for man and machine

BERNSTEIN AG ranks among the world's leading providers of industrial safety technology. With our comprehensive range of switches, sensors, enclosures, suspension systems and other components for industrial applications, we offer our customers effective and versatile solutions.

In-depth market knowledge, the close proximity to end users as well as years of experience in mechanical engineering and electronics are reflected down to the last detail in our products.

By conforming to international safety guidelines, our products perfectly integrate in individual system solutions. Our focus is complete commitment to safety for man, machine and industrial processes.

### Our expertise for your safety

With sound application expertise we support our customers from all branches of industry in the planning and implementation of systems designed to meet stringent safety requirements. In addition to classic plant and machine construction, we look after customers in the lift construction, automotive, agriculture, conveyor construction, automation engineering, wood-working, renewable energy, AS-Interface and EX.



# Our knowledge is your success



**GERMANY**  
Porta Westfalica  
BERNSTEIN  
BUSINESS CENTER



**GERMANY**  
Hille-Hartum



**EUROPE**  
Budapest (Hungary)  
BERNSTEIN Kft.

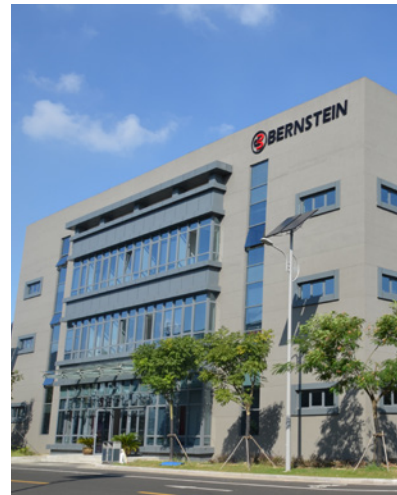

**ASIA**  
Taicang (China)  
BERNSTEIN Safe Solutions

## Our philosophy

Customer Satisfaction is our number one priority. For us, Quality is more than making a good product, it's about designing them to perfectly match ALL of your needs.

Customized Solutions are fully integrated into our business and form part of our everyday working life. Employees are treated as our greatest asset as they are responsible for the quality and success of our products. All BERNSTEIN TEAM members are trained and educated to the highest possible standard so they can deliver "Best in Class" Service and Support. The BERNSTEIN TEAM will support you both personally and professionally, working together we will provide you with the best Safe Solution – for any size of project.

## Future-proof solutions

Our objective is to actively influence technical innovation and modern application solutions. BERNSTEIN has therefore always been at the centre of defining trends in technology. With an unwavering commitment to the future we will continue providing the best possible answers in terms of technology, ecology and economic efficiency.

That is our definition of progress!

# BERNSTEIN AG

## The Product Lines

### Switch Systems



#### Switch systems – Economy meets safety

BERNSTEIN electromechanical switches offer a convincing price/performance ratio and impress with their extreme reliability for many different operating voltages. The range extends from limit switches, encapsulated in insulating material or metal, through foot switches to safety switching devices. The AS-i compatible products save time and material in installation and provide cost advantages in operation. The comprehensive range of designs and sizes, the possible switching functions and the choice of actuators make virtually any application reality.

### Sensor Systems

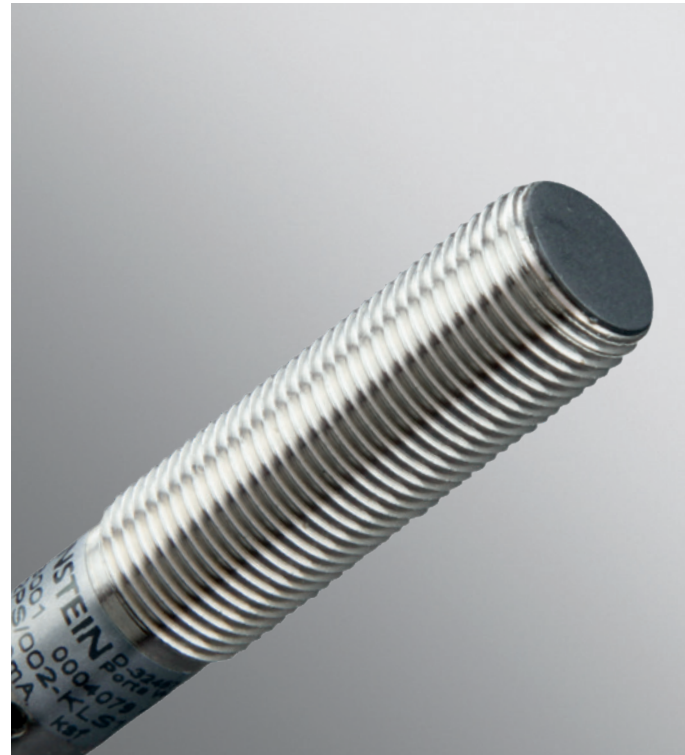

#### Sensor systems – Compact intelligence

The extremely fast and exceptionally precise BERNSTEIN sensors operate without interference and wear in all applications. The tried-and-tested reliability and the compact dimensions are greatly appreciated in all branches of industry. Matching the specific application, in addition to ultrasonic sensors and level switches, customers can choose from a wide range of inductive, capacitive, magnetic or optical sensors. Alongside the comprehensive standard range of sensors, we also offer comprehensive development and design for individual solutions.

## Enclosure Systems



### **Enclosure systems – Function and design**

With its long tradition in manufacturing enclosures, BERNSTEIN combines superior enclosure technology, designed for encapsulating a diverse range of applications, with ultramodern and variable suspension systems. An extensive range of aluminium and plastic terminal boxes as well as the wiring and circuitry in standard and control enclosures conforming to specific customer requirements round off the product portfolio. Our enclosures conform to standards used in medical technology, industry as well as food and EX applications.

# Product Line Sensor Systems





### **Sensor systems – Compact intelligence**

BERNSTEIN is an established manufacturer of high quality electromechanical and electronic low voltage switching devices and sensors. Our products are used in the most diverse range of applications, ranging from lift construction through wood-working and packaging machines through to machine tools.

Contactless sensors are characterised by absolute reliability, suitability for a wide range of applications and optimum cost-benefit ratio. Their main purpose is to convert mechanical movement into electrical signals that are processed in control systems.

In modern day applications, however, sensors directly connected to bus systems are being used to an ever greater extent to monitor mechanical movement and convert it into digital information.

Selecting the right sensor for the job depends on the prevailing ambient and operating conditions as well as corresponding technical requirements. In addition to the detection method (inductive, capacitive, optical, ultrasonic or magnetic) it is also necessary to select the corresponding output function (PNP, NPN, AC, normally-closed or normally-open contact). Sensing distances as well as the direction and type of approach are also important selection criteria. In view of the large number of possible combinations, the scope of application is virtually unlimited.

### **Maximum functions – minimum space**

The range of applications in which limit switches are used has changed in line with increasing automation. Sensors are no longer used purely for the purpose of detecting position but rather they must be able to output analogue values for the purpose of calculating the distance with the necessary signal processing already taking place in the sensor itself. A sensor can also be used to sample two switching points in order to reduce the number of components in machines and systems.

This functionality is achieved by the use of state-of-the-art microcontrollers and advanced sensor technologies. Modern sensors from BERNSTEIN therefore open up new applications, extend the range of functions and as a result significantly increase efficiency.

### **Complementing our product range we offer attractive customer services:**

- Assistance in assessing risk and configuring safety functions
- Preassembly of products with standard power supply lines or customised cables
- Supply of M8 or M12 connection technology
- Development of sensors to customer specifications
- Development and manufacture of customer-specific system solutions



## Inductive Sensors

Type	Page
General	12
 <ul style="list-style-type: none"> <li>• ø 3 mm</li> <li>• ø 4 mm</li> <li>• ø 6,5 mm</li> <li>• M4</li> <li>• M5</li> </ul>	14
 <ul style="list-style-type: none"> <li>• M8</li> </ul>	16
 <ul style="list-style-type: none"> <li>• M12</li> </ul>	18
 <ul style="list-style-type: none"> <li>• M18</li> </ul>	22
 <ul style="list-style-type: none"> <li>• M30</li> </ul>	28
 <ul style="list-style-type: none"> <li>• ø 34 mm</li> </ul>	32
 <ul style="list-style-type: none"> <li>• 5 x 5 x 25 mm</li> <li>• 8 x 8 x 40 mm</li> <li>• 8 x 8 x 56 mm</li> <li>• 12 x 12 x 55 mm</li> </ul>	32
 <ul style="list-style-type: none"> <li>• 27 x 10 x 5 mm</li> <li>• 28 x 16 x 11 mm</li> <li>• 40 x 26 x 12 mm</li> <li>• 50 x 25 x 10 mm</li> <li>• 60 x 36 x 10 mm</li> </ul>	33
 <ul style="list-style-type: none"> <li>• 68 x 30 x 15 mm</li> <li>• 40 x 40 mm</li> </ul>	36

## Capacitive Sensors

Type	Page
General	38
 <ul style="list-style-type: none"> <li>• M12</li> <li>• M18</li> </ul>	42
 <ul style="list-style-type: none"> <li>• M30</li> <li>• M32</li> </ul>	44
 <ul style="list-style-type: none"> <li>• ø 20 mm</li> <li>• ø 34 mm</li> </ul>	46
 <ul style="list-style-type: none"> <li>• 50 x 25 x 10 mm</li> <li>• 68 x 30 x 15 mm</li> </ul>	47

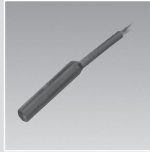

## Magnetic Switches

Type	Page
General	48
 <ul style="list-style-type: none"> <li>Electromechanical magnetic switches <ul style="list-style-type: none"> <li>• Plastic</li> <li>• Metal</li> </ul> </li> </ul>	52
General	60
 <ul style="list-style-type: none"> <li>Electronic magnetic sensors <ul style="list-style-type: none"> <li>• Plastic</li> <li>• Metal</li> </ul> </li> </ul>	62

## Slot Sensors

Type	Page
General	71
 <ul style="list-style-type: none"> <li>• E22</li> <li>• E30</li> <li>• Analogue</li> <li>• Teachable</li> <li>• Electronic</li> <li>• Reed contact</li> </ul>	72

## Contactless safety technology

Type	Page
 <ul style="list-style-type: none"> <li>Non-contact Safety Sensor SRF</li> </ul>	75
 <ul style="list-style-type: none"> <li>Magnetic Monitoring Systems</li> </ul>	84

## Accessories



**Magnets** 88



**Cable couplers** 94

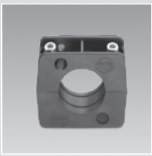

**• Mounting brackets** 96



**Sensor tester** 98

## Annex

**Type code** 100

**Wiring diagrams** 109



# Inductive Sensors

## Functional principle

In general, inductive proximity switches consist of four basic elements: a coil, an oscillator, a threshold switch and an output stage with short-circuit protection. The oscillator generates a high frequency, electromagnetic alternating field which is emitted from the active face of the coil. Eddy currents are induced in a metal object that enters this field. These eddy currents draw energy from both the electromagnetic field and from the oscillator which is consequently attenuated. The more energy taken the closer the metal object moves towards the active face. The threshold switch switches on the output stage at a defined attenuation value. In proximity switches with a DC voltage supply, this switch is designed as an NPN transistor which switches the connected load to the negative pole or as a PNP transistor which switches the load to the positive pole. The output stage is a thyristor or a triac in AC voltage switches.

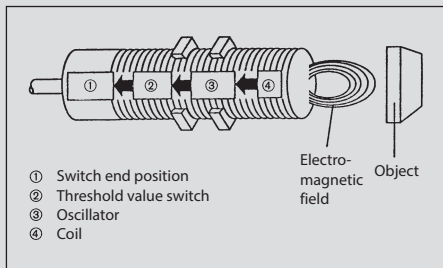

## Sensing distance

The sensing distance (gap) is determined by the coil diameter, i.e. larger sensors are required for larger sensing distances. The sensing distance is also dependent on the size of the metal object to be detected as well as the material it is made from.

## Target

The sensing distance is measured with a 1 mm thick square measuring plate made of steel (ST 37) referred to as a target. The edge length is equal to the diameter of the active face or equal to three times the sensing distance depending on which value is greater.

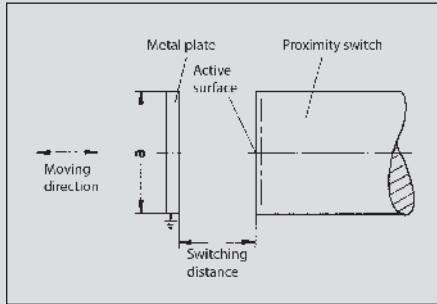

## Nominal sensing distance: (Sn)

The nominal sensing distance is a device-specific characteristic value that is dependent on the coil diameter.

## Real sensing distance: (Sr)

The real sensing distance is measured at nominal voltage and nominal temperature. It must be between 90 % – 110 % of the nominal sensing distance.

## Useable sensing distance: (Su)

The useable sensing distance is measured within the permissible temperature and voltage ranges and is 90 % – 110 % of the real sensing distance.

## Operational sensing distance: (Sa)

(Assured operation distance)

The operational sensing distance takes into account the influence of the supply voltage, temperature and control systems. Reliable switching under all permissible operating conditions is assured within 0 % – 81 % of the nominal sensing distance.  $S_a \sim 0.81 S_n$ .

## Hysteresis: (H)

Hysteresis refers to the difference between the switch-on point as an object approaches and the switch-off point as the object moves away. This hysteresis is specified as a percentage of the nominal sensing distance and is typically 10 %. It is required to prevent the output chattering in response to slowly approaching objects, temperature drift, electrical interference or vibration.

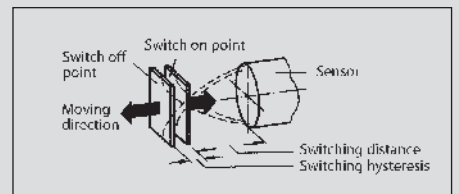
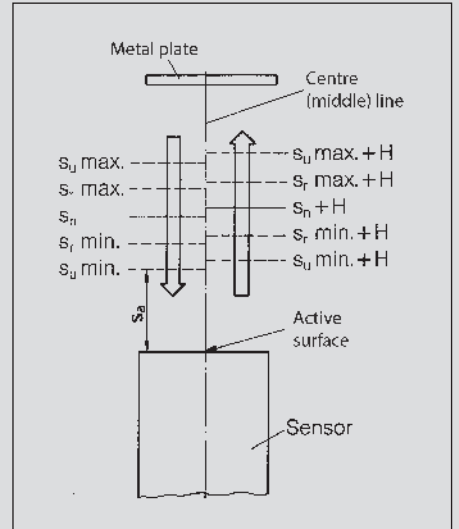

## Repeatability

Repeatability is the ability of a sensor to repeatedly detect an object at the same distance away from the sensing surface. The typical deviation is < 5 %.

## Reduction factors

The definition of the sensing distance is based on the measurement performed with a standardised square target made of steel. If other materials with the same dimensions are used, the sensing distance will be reduced as shown in the following graphic.

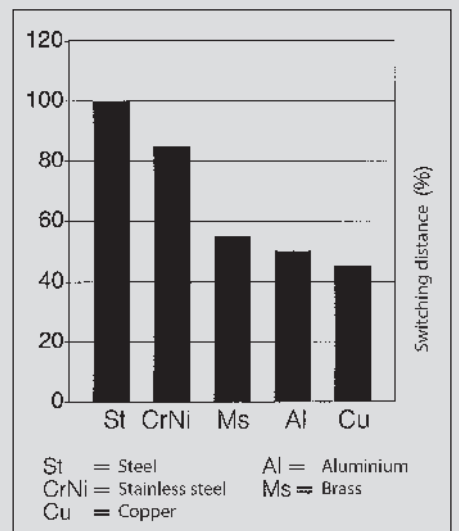

### Switching frequency

The switching frequency is measured with a redating, non-conductive plate, on which the standard targets are mounted as illustrated (size of targets as previously defined).

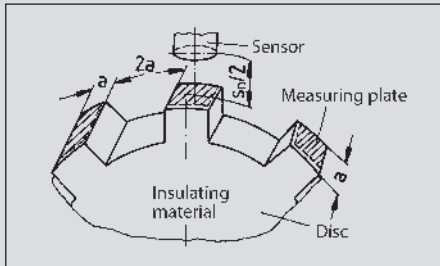

The distance between the targets and sensor is equal to half the nominal sensing distance. The maximum switching frequency is reached when the switch-on or switch-off signal time drops below 50  $\mu$ s.

### Temperature range

For most sensors, the permissible ambient temperature range is between  $-25^{\circ}\text{C}$  and  $+70^{\circ}\text{C}$  ( $-13^{\circ}\text{F}$  to  $+158^{\circ}\text{F}$ ). Sensors with an extended temperature range of  $-40^{\circ}\text{C}$  to  $+100^{\circ}\text{C}$  are also available.

### Assembly

Inductive sensors contain a coil on a ferromagnetic core that bundles the electromagnetic alternating field. The core is installed into the enclosure in such a way that the field emerges from the switch at the active face. A part of the magnetic field, however, also emerges from the side of the core. The sensor in a flush mount arrangement would already be influenced by the metal on the sides. For this reason, a metal band is fitted about the core in plastic enclosures, thus restricting the lateral magnetic field in a flush mount configuration. Due to the pre-attenuation attributed to the metal ring or a metal enclosure, flush mount versions have a shorter sensing distance than non-flush mount sensors and can be mounted closer to each other.

### Flush mount

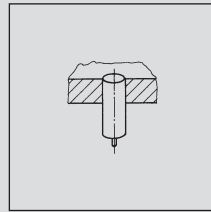

The active face can be flush with a metal surface.

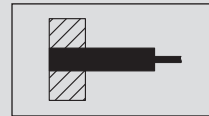

Catalogue symbol for flush mount

### Non-flush mount

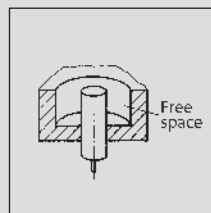

Sensors for non-flush mount require a clearance equal to three times the sensor enclosure diameter and a min. depth of 2x Sn.

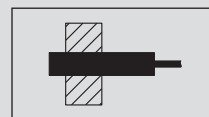

Catalogue symbol for non-flush mount

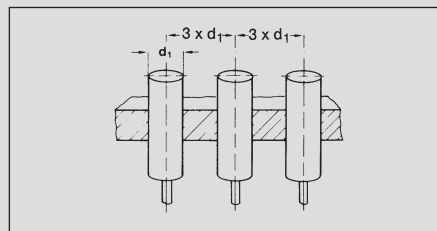

Minimum spacing between non-flush mount sensors

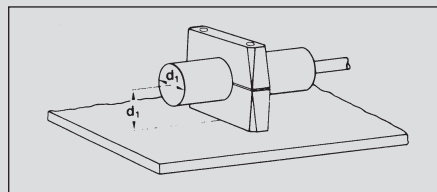

Installation with a mounting bracket parallel to a steel wall

### NAMUR sensors

(Standardization association for measurement and control in chemical industries)

### Protection class

Corresponding to their ID code, the enclosures are dustproof and waterproof in accordance with IP65 or IP67 (EN 60529).

### Short-circuit protection

Standard sensors are protected against short-circuit (cyclic) and polarity reversal.

### Tightening torque requirements

BERNSTEIN supplies corresponding mounting nuts with its sensors. Refer to the respective datasheets for the required tightening torque.

#### Tightening torque examples for sensors in brass enclosure:

M4	0.8 Nm
M5	1.5 Nm
M8	8 Nm
M12	10 Nm
M18	25 Nm
M30	70 Nm

### Materials

The sensors are protected by a glass fibre reinforced thermoplastic, brass or stainless steel enclosure. The connection cable has a PVC or PU sheathing.

### Connection systems

The following connection systems are available for standard sensors:

- Cable variants (2 m) with PVC or PUR sheathing
- Connector variants with M8, M12 connector or connector conforming to DIN 43650
- Quick-connect system with Ultralock connectors

### Standards and approvals

All sensors are CE-certified. The following European standards apply in accordance with CENELEC:

- EN 60947-5-2 Proximity switches
- EN 60947-5-6 NAMUR sensors

# Inductive Sensors (Type Ø 3 mm, Ø 4 mm, Ø 6.5 mm, M4, M5)

Type	Ø 3 mm	Ø 4 mm	Ø 6.5 mm	
Type of installation	Flush	Flush	Flush	Flush
Nominal sensing distance	0.6 mm	0.8 mm	1.5 mm	1.5 mm
Type of connection	Cable 2 m	Cable 2 m	Cable 2 m	Connector M8
Special feature				

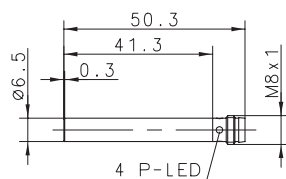
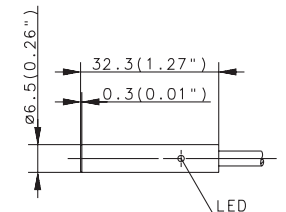
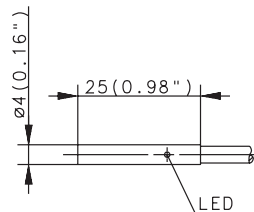
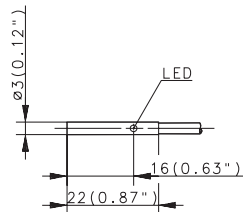

<b>PNP</b>	DC	NO contact	<b>6502999019</b> KIB-D03PS/0,6-KL2PU	<b>6502999004</b> KIB-D04PS/0,8-KL2PU	<b>6502999010</b> KIB-D06PS/1,5-KL2	<b>6502999012</b> KIB-D06PS/1,5-KLSM8
		NC contact				
<b>NPN</b>	DC	NO contact	<b>6502799007</b> KIB-D03PÖ/0,6-KL2PU	<b>6502799002</b> KIB-D04PÖ/0,8-KL2PU	<b>6502799011</b> KIB-D06PÖ/1,5-KL2	
		NC contact				
<b>PNP/NPN</b>	DC	NO/NC prog. push-pull operation				
<b>NAMUR</b>	DC	Type				
<b>Analogue</b>	DC					
<b>2-wire</b>	DC	NO contact				
		NC contact				
	AC	NO contact				
		NC contact				
		Changeover contact				

## Technical data

Rated operating voltage	$U_B$	10–30 VDC	10–30 VDC	10–36 VDC	10–36 VDC
Rated operating current	$I_B$	≤ 100 mA	≤ 200 mA	≤ 200 mA	≤ 200 mA
Switching frequency (max)	F	3000 Hz	3000 Hz	1000 Hz	1000 Hz
Short circuit-protection		Cyclic	Cyclic	Cyclic	Cyclic
Function/operating voltage indicator		LED/-	LED/-	LED/-	LED/-
Sensing distance, adjustable					

## Mechanical data

Ambient temperature (min/max)		-25°C/+70°C	-25°C/+70°C	-25°C/+70°C	-25°C/+70°C
Protection class in accordance with IEC 529, EN 60529		IP67	IP67	IP67	IP67
Enclosure material		Stainless steel 1.4305	Stainless steel 1.4401	Stainless steel 1.4401	Stainless steel 1.4401
Connection		3 x 0.055 mm <sup>2</sup>	3 x 0.14 mm <sup>2</sup>	3 x 0.14 mm <sup>2</sup>	M8 x 1

Please refer to Accessories for cable couplers, mounting brackets and sensor tester.



Ø 6.5 mm		M4	M5	M5	
Flush	Flush	Flush	Flush	Flush	Flush
1.5 mm	1.5 mm	0.6 mm	1 mm	1 mm	1 mm
Cable 2 m	Cable 5 m	Cable 2 m	Cable 2 m	Connector M8	Cable 2 m
					NAMUR

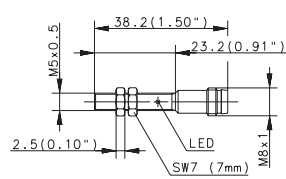
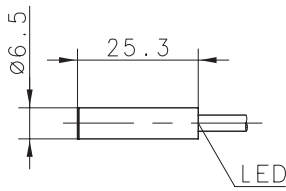
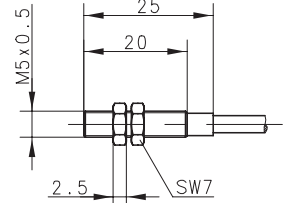
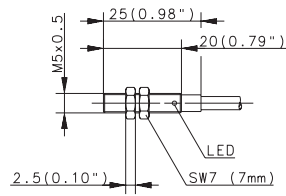
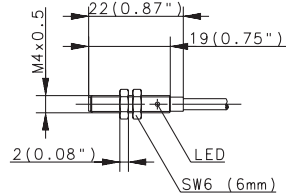
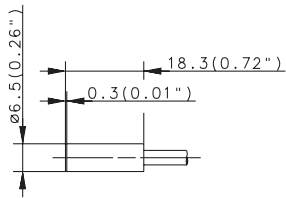

<b>6502999034</b> KIB-D06PS/1,5-K2VPU	<b>6602999460</b> KIB-D06PS/1,5-KL5V	<b>6502999020</b> KIB-M04PS/0,6-KL2PU		<b>6502999003</b> KIB-M05PS/001-KL2PU	<b>6502999018</b> KIB-M05PS/001-KLSM8		
				<b>6502799001</b> KIB-M05PÖ/001-KL2PU	<b>6502799019</b> KIB-M05PÖ/001-KLSM8		
				<b>6502399003</b> KIB-M05NS/001-KL2PU			
						<b>6501699008</b> KIB-M05EA/001-2	

10-36 VDC	10-36 VDC	10-30 VDC	10-30 VDC	10-30 VDC	5-25 VDC
≤ 200 mA	≤ 200 mA	≤ 100 mA	≤ 200 mA	≤ 200 mA	-
1000 Hz	1000 Hz	3000 Hz	3000 Hz	3000 Hz	≈ 3 kHz
Cyclic	Cyclic	Cyclic	Cyclic	Cyclic	-
-/-	LED/-	LED/-	LED/-	LED/-	-/-

-25°C/+70°C	-25°C/+70°C	-25°C/+70°C	-25°C/+70°C	-25°C/+70°C	-25°C/+70°C
IP67	IP67	IP67	IP67	IP67	IP67
Stainless steel 1.4401	Stainless steel 1.4401	Stainless steel 1.4305	CuZn39Pb3	CuZn39Pb3	CuZn39Pb3
3 x 0.14 mm <sup>2</sup>	3 x 0.14 mm <sup>2</sup>	3 x 0.055 mm <sup>2</sup>	3 x 0.14 mm <sup>2</sup>	M8 x 1	2 x 0.14 mm <sup>2</sup>

You will find detailed data sheets to the products under [www.bernstein.eu](http://www.bernstein.eu)



# Inductive Sensors (Type M8)

Type	M8		M8		M8
Type of installation	Flush	Flush	Flush	Flush	Flush
Nominal sensing distance	1.5 mm	1.5 mm	1.5 mm	1.5 mm	1.5 mm
Type of connection	Cable 2 m	Cable 6 m	Connector M8	Connector M8	Connector M12
Special feature					

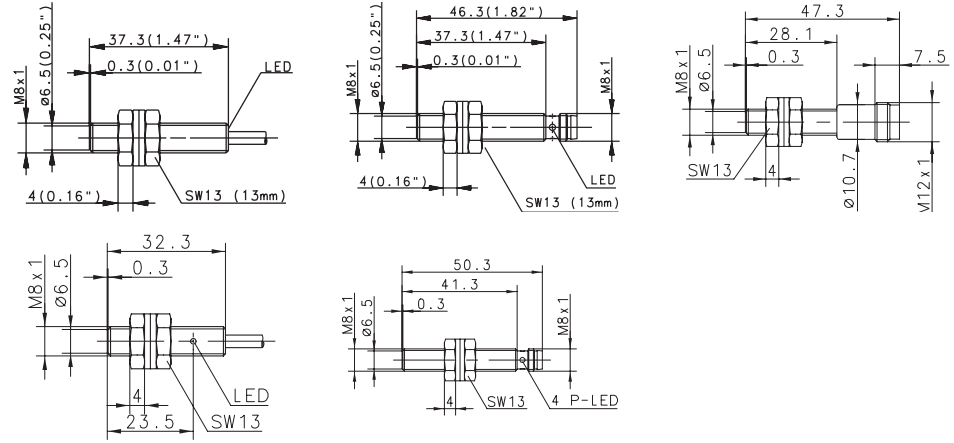

<b>PNP</b>	DC	NO contact Type NC contact Type Antivalent NO/NC	<b>6932901001</b> KIB-M08PS/1,5-KL2	<b>6502901004</b> KIB-M08PS/1,5-KL6 <b>6502701001</b> KIB-M08PÖ/1,5-KL2	<b>6932942001</b> KIB-M08PS/1,5-KLSM8	<b>6502742001</b> KIB-M08PÖ/1,5-KLSM8	<b>6502942007</b> KIB-M08PS/0,1-KS12
<b>NPN</b>	DC	NO contact Type NC contact Antivalent NO/NC	<b>6932301001</b> KIB-M08NS/1,5-KL2		<b>6932342001</b> KIB-M08NS/1,5-KLSM8		
<b>PNP/NPN</b>	DC	NO/NC prog. push-pull operation					
<b>NAMUR</b>	DC	Type					
<b>Analogue</b>	DC						
<b>2-wire</b>	DC	NO contact NC contact					
	AC	NO contact NC contact Changeover contact					

### Technical data

Rated operating voltage	$U_B$	10–36 VDC	10–36 VDC	10–36 VDC	10–36 VDC	10–36 VDC
Rated operating current	$I_B$	≤ 200 mA	≤ 200 mA	≤ 200 mA	≤ 200 mA	≤ 200 mA
Switching frequency (max)	F	1000 Hz	1000 Hz	1000 Hz	1000 Hz	1000 Hz
Short circuit-protection		Cyclic	Cyclic	Cyclic	Cyclic	Cyclic
Function/operating voltage indicator		LED/-	LED/-	LED/-	LED/-	-/-
Sensing distance, adjustable						

### Mechanical data

Ambient temperature (min/max)		-25°C/+70°C	-25°C/+70°C	-25°C/+70°C	-25°C/+70°C	-25°C/+70°C
Protection class in accordance with IEC 529, EN 60529		IP67	IP67	IP67	IP67	IP67
Enclosure material		Stainless steel 1.4305	Stainless steel 1.4305	Stainless steel 1.4305	Stainless steel 1.4305	Stainless steel 1.4305
Connection		3 x 0.14 mm <sup>2</sup>	3 x 0.14 mm <sup>2</sup>	M8 x 1	M8 x 1	M12 x 1

Please refer to Accessories for cable couplers, mounting brackets and sensor tester.



<b>M8</b>	<b>M8</b>	<b>M8</b>	
Flush	Non-flush	Non-flush	Non-flush
1.5 mm	2 mm	2 mm	2 mm
Cable 2 m	Cable 2 m	Connector M8	Connector M12
NAMUR			

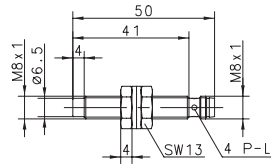
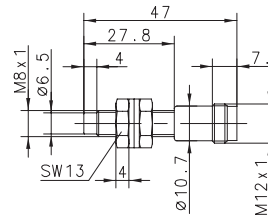
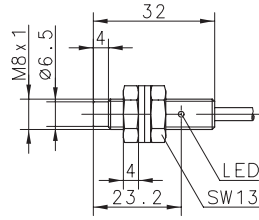
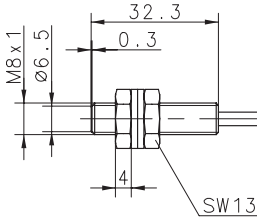

		<b>6502916003</b> KIN-M08PS/002-KL2	<b>6502942006</b> KIN-M08PS/002-KLSM8	<b>6502942008</b> KIN-M08PS/002-KS12		
<b>6501601003</b> KIB-M08EA/1,5-2						

5-25 VDC	10-36 VDC	10-36 VDC	10-36 VDC
-	≤ 200 mA	≤ 200 mA	≤ 200 mA
≈ 1 kHz	750 Hz	750 Hz	750 Hz
-	Cyclic	Cyclic	Cyclic
-/-	LED/-	LED/-	-/-

-25°C/+70°C	-25°C/+70°C	-25°C/+70°C	-25°C/+70°C
IP67	IP67	IP67	IP67
Stainless steel 1.4305	Stainless steel 1.4305	Stainless steel 1.4305	Stainless steel 1.4305
2 x 0.25 mm <sup>2</sup>	3 x 0.14 mm <sup>2</sup>	M8 x 1	M12 x 1

You will find detailed data sheets to the products under [www.bernstein.eu](http://www.bernstein.eu)



# Inductive Sensors (Type M8, M12)

Type	M8	M12	M12	M12
Type of installation	Non-flush	Flush	Flush	Flush
Nominal sensing distance	2 mm	2 mm	2 mm	2 mm
Type of connection	Cable 2 m	Cable 2 m	Cable 2 m	Connector M12
Special feature	NAMUR			

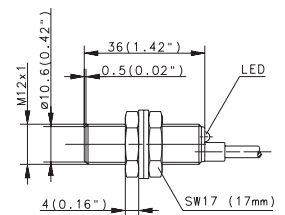
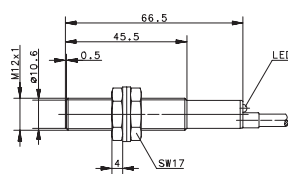
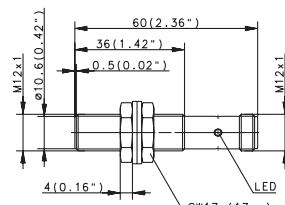
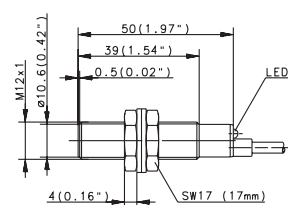
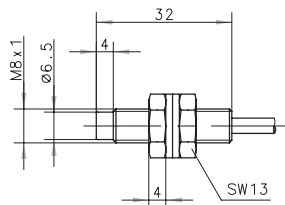

<b>PNP</b>	DC	NO contact Type NC contact Type Antivalent NO/NC		<b>6932903001</b> KIB-M12PS/002-KL2	<b>6932943001</b> KIB-M12PS/002-KLS12 <b>6602743112</b> KIB-M12PÖ/002-KLS12	<b>6502903016</b> KIB-M12PS/002-KL2V <b>6502703005</b> KIB-M12PÖ/002-KL2V
<b>NPN</b>	DC	NO contact Type NC contact Type Antivalent NO/NC		<b>6932303001</b> KIB-M12NS/002-KL2	<b>6932343001</b> KIB-M12NS/002-KLS12	<b>6502103003</b> KIB-M12NÖ/002-KL2V
<b>PNP/NPN</b>	DC	NO/NC prog. push-pull operation				
<b>NAMUR</b>	DC	Type		<b>6501601005</b> KIN-M08EA/002-2		
<b>Analogue</b>	DC					
<b>2-wire</b>	DC	NO contact NC contact				
	AC	NO contact Type NC contact Changeover contact		<b>6503503001</b> KIB-M12AS/002-L2		

## Technical data

Rated operating voltage	$U_B$	5–25 VDC	10–36 VDC	76–250 V AC	10–36 VDC	10–36 VDC
Rated operating current	$I_B$	–	≤ 200 mA	≤ 200 mA	≤ 200 mA	≤ 200 mA
Switching frequency (max)	F	≈ 1 kHz	800 Hz	≈ 10 Hz	800 Hz	800 Hz
Short circuit-protection		–	Cyclic	–	Cyclic	Cyclic
Function/operating voltage indicator		–/–	LED/–	LED/–	LED/–	LED/–
Sensing distance, adjustable						

## Mechanical data

Ambient temperature (min/max)		–25°C/+70°C	–25°C/+70°C	–25°C/+70°C	–25°C/+70°C	–25°C/+70°C
Protection class in accordance with IEC 529, EN 60529		IP67	IP67	IP67	IP67	IP67
Enclosure material		Stainless steel 1.4305	CuZn39Pb3	CuZn39Pb3	CuZn39Pb3	CuZn39Pb3
Connection		2 x 0.25 mm <sup>2</sup>	3 x 0.14 mm <sup>2</sup>	2 x 0.14 mm <sup>2</sup>	M12 x 1	3 x 0.14 mm <sup>2</sup>

Please refer to Accessories for cable couplers, mounting brackets and sensor tester.





<b>M12</b>	<b>M12</b>	<b>M12</b>	
Flush 2 mm Connector M8	Flush 2 mm Connector M12	Flush 2 mm Cable 2 m 4000 Hz	Flush 2 mm Cable 2 m NAMUR

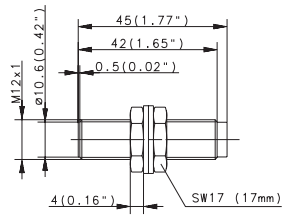
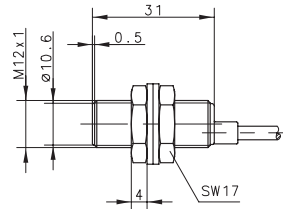
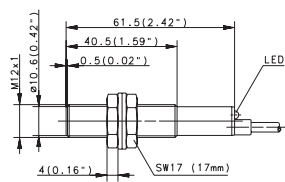
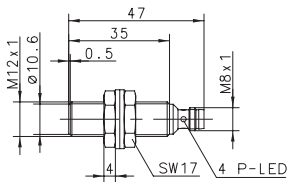

<b>6502943008</b> KIB-M12PS/002-KLSM8V	<b>6502943006</b> KIB-M12PS/002-KS12V <b>6502743005</b> KIB-M12PÖ/002-KS12V	<b>6502903012</b> KIB-M12PS/002-KL2F				
				<b>6501624760</b> KIB-M12EA/002-2		

10–30 VDC	10–36 VDC	10–60 VDC	5–25 VDC
≤ 200 mA	≤ 200 mA	≤ 200 mA	–
800 Hz	800 Hz	4000 Hz	≤ 800 Hz
Cyclic	Cyclic	Cyclic	–
LED/–	–/–	LED/–	–/–

–25°C/+70°C	–25°C/+70°C	–25°C/+70°C	–25°C/+70°C
IP67	IP67	IP67	IP67
CuZn39Pb3	CuZn39Pb3	CuZn39Pb3	CuZn39Pb3
M8 x 1	M12 x 1	3 x 0.14 mm <sup>2</sup>	2 x 0.25 mm <sup>2</sup>

You will find detailed data sheets to the products under [www.bernstein.eu](http://www.bernstein.eu)



# Inductive Sensors (Type M12)

Type	M12		M12		M12	
Type of installation	Flush	Flush	Flush	Non-flush	Non-flush	
Nominal sensing distance	4 mm	4 mm	4 mm	4 mm	4 mm	
Type of connection	Cable 2 m	Connector M12	Cable 2 m	Cable 2 m	Cable 2 m	
Special feature	Sensing dist.	Sensing dist.	Sensing dist.			

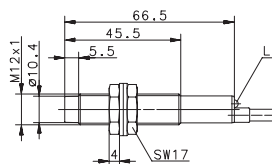
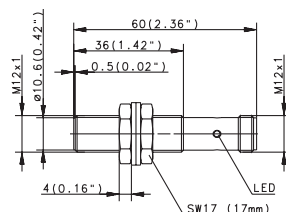
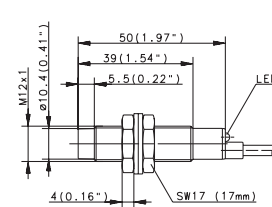
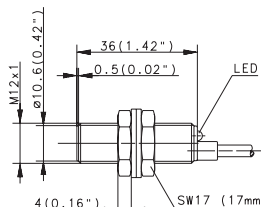
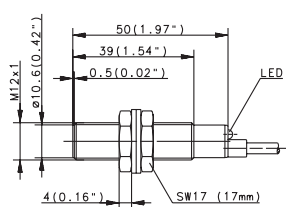

<b>PNP</b>	DC	NO contact	<b>6502903025</b> KIB-M12PS/004-KL2E	<b>6502943015</b> KIB-M12PS/004-KLS12E	<b>6502903023</b> KIB-M12PS/004-KL2VE	<b>6932904001</b> KIN-M12PS/004-KL2	<b>6932704001</b> KIN-M12PÖ/004-KL2
		Type NC contact Type Antivalent NO/NC					
<b>NPN</b>	DC	NO contact				<b>6932304001</b> KIN-M12NS/004-KL2	<b>6932104001</b> KIN-M12NÖ/004-KL2
		Type NC contact Type Antivalent NO/NC					
<b>PNP/NPN</b>	DC	NO/NC prog. push-pull operation					
<b>NAMUR</b>	DC						
<b>Analogue</b>	DC						
<b>2-wire</b>	DC	NO contact					<b>6503504001</b> KIN-M12AS/004-L2
		NC contact					
	AC	NO contact					<b>6503404001</b> KIN-M12ÄÖ/004-L2
		Type NC contact Type Changeover contact					

## Technical data

Rated operating voltage	$U_B$	10–30 VDC	10–36 VDC	10–36 VDC	10–36 VDC	76–250 V AC
Rated operating current	$I_B$	≤ 200 mA	≤ 200 mA	≤ 200 mA	≤ 200 mA	≤ 200 mA
Switching frequency (max)	F	800 Hz	800 Hz	800 Hz	400 Hz	≈ 10 Hz
Short circuit-protection		Cyclic	Cyclic	Cyclic	Cyclic	–
Function/operating voltage indicator		LED/–	LED/–	LED/–	LED/–	LED/–
Sensing distance, adjustable						

## Mechanical data

Ambient temperature (min/max)	–25°C/+70°C	–25°C/+70°C	–25°C/+70°C	–25°C/+70°C	–25°C/+70°C
Protection class in accordance with IEC 529, EN 60529	IP67	IP67	IP67	IP67	IP67
Enclosure material	CuZn39Pb3	CuZn39Pb3	CuZn39Pb3	CuZn39Pb3	CuZn39Pb3
Connection	3 x 0.14 mm <sup>2</sup>	M12 x 1	3 x 0.14 mm <sup>2</sup>	3 x 0.14 mm <sup>2</sup>	2 x 0.14 mm <sup>2</sup>

Please refer to Accessories for cable couplers, mounting brackets and sensor tester.



M12		M12			
Non-flush 4 mm Connector M12	Non-flush 4 mm Cable 2 m	Non-flush 4 mm Connector M12	Non-flush 4 mm Cable 2 m Plastic		

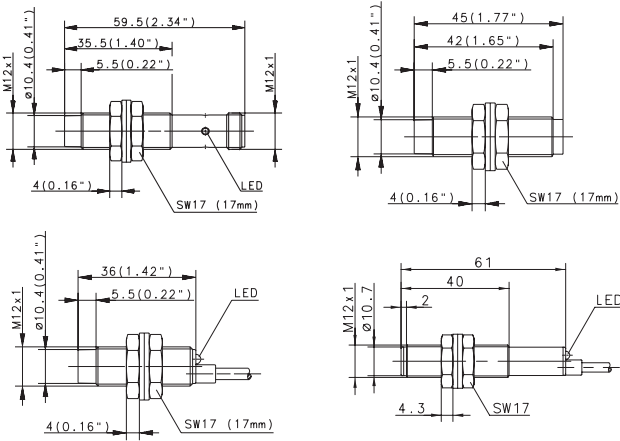

<b>6932944001</b> KIN-M12PS/004-KLS12	<b>6502904014</b> KIN-M12PS/004-KL2V	<b>6502944006</b> KIN-M12PS/004-KS12V	<b>6502919001</b> KIN-T12PS/004-KL2				
<b>6502744003</b> KIN-M12PÖ/004-KLS12							
<b>6932344001</b> KIN-M12NS/004-KLS12							

10–36 VDC	10–36 VDC	10–36 VDC	10–30 VDC		
≤ 200 mA	≤ 200 mA	≤ 200 mA	≤ 200 mA		
400 Hz	400 Hz	400 Hz	400 Hz		
Cyclic	Cyclic	Cyclic	Cyclic		
LED/–	LED/–	–/–	LED/–		

–25°C/+70°C	–25°C/+70°C	–25°C/+70°C	–25°C/+70°C		
IP67	IP67	IP67	IP67		
CuZn39Pb3	CuZn39Pb3	CuZn39Pb3	PA, red		
M12 x 1	3 x 0.14 mm <sup>2</sup>	M12 x 1	3 x 0.14 mm <sup>2</sup>		

You will find detailed data sheets to the products under [www.bernstein.eu](http://www.bernstein.eu)



# Inductive Sensors (Type M12, M18)

Type	M12	M12	M12	M18	M18
Type of installation	Non-flush	Non-flush	Non-flush	Flush	Flush
Nominal sensing distance	4 mm	8 mm	8 mm	5 mm	5 mm
Type of connection	Cable 2 m	Cable 2 m	Connector M12	Cable 2 m	Cable 2 m
Special feature	NAMUR	Sensing dist.	Sensing dist.		

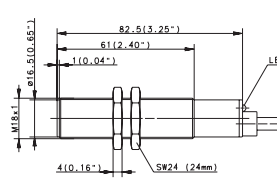
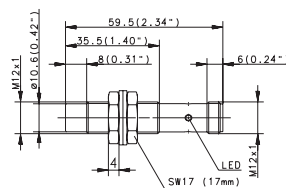
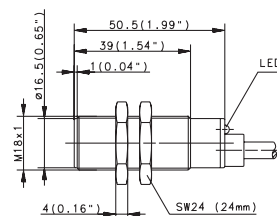
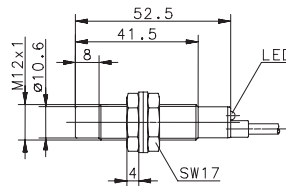
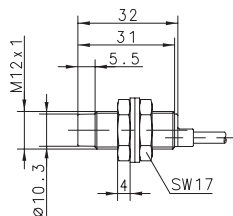

<b>PNP</b>	DC	NO contact Type NC contact Type Antivalent NO/NC Type		<b>6502904021</b> KIN-M12PS/008-KL2E	<b>6502944013</b> KIN-M12PS/008-KLS12E	<b>6932905001</b> KIB-M18PS/005-KL2 <b>6932705001</b> KIB-M18PÖ/005-KL2
<b>NPN</b>	DC	NO contact Type NC contact Type Antivalent NO/NC Type			<b>6602344458</b> KIN-M12NS/008-KLS12E	<b>6932105001</b> KIB-M18NÖ/005-KL2
<b>PNP/NPN</b>	DC	NO/NC prog. push-pull operation				
<b>NAMUR</b>	DC	Type	<b>6501625761</b> KIN-M12EA/004-2			
<b>Analogue</b>	DC					
<b>2-wire</b>	DC	NO contact NC contact				
	AC	NO contact Type NC contact Type Changeover contact				<b>6503505004</b> KIB-M18AS/005-L2 <b>6503405001</b> KIB-M18AÖ/005-L2

### Technical data

Rated operating voltage	$U_B$	5–25 VDC	10–36 VDC	10–36 VDC	10–36 VDC	20–250 V AC
Rated operating current	$I_B$	–	≤ 200 mA	≤ 200 mA	≤ 200 mA	≤ 400 mA
Switching frequency (max)	F	≤ 400 Hz	400 Hz	400 Hz	500 Hz	≈ 10 Hz
Short circuit-protection		–	Cyclic	Cyclic	Cyclic	–
Function/operating voltage indicator		–/–	LED/–	LED/–	LED/–	LED/–
Sensing distance, adjustable						

### Mechanical data

Ambient temperature (min/max)		–25°C/+70°C	–25°C/+70°C	–25°C/+70°C	–25°C/+70°C	–25°C/+70°C
Protection class in accordance with IEC 529, EN 60529		IP67	IP67	IP67	IP67	IP67
Enclosure material		CuZn39Pb3	CuZn39Pb3	CuZn39Pb3	CuZn39Pb3	CuZn39Pb3
Connection		2 x 0.25 mm <sup>2</sup>	3 x 0.14 mm <sup>2</sup>	M12 x 1	3 x 0.5 mm <sup>2</sup>	2 x 0.5 mm <sup>2</sup>

Please refer to Accessories for cable couplers, mounting brackets and sensor tester.



M18		M18		M18		M18	
Flush 5 mm Connector M12	Flush 5 mm Cable 6 m	Flush 5 mm Connector M12	Flush 5 mm DIN Connector	Flush 5 mm DIN Connector	Flush 5 mm DIN Connector	Flush 5 mm Cable 2 m Plastic	Flush 5 mm Cable 2 m Plastic

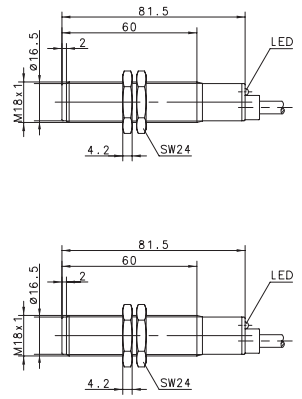
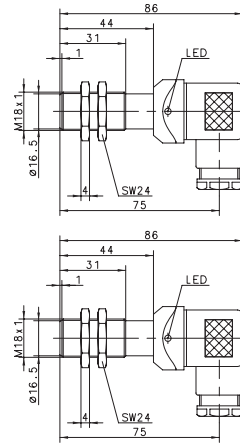
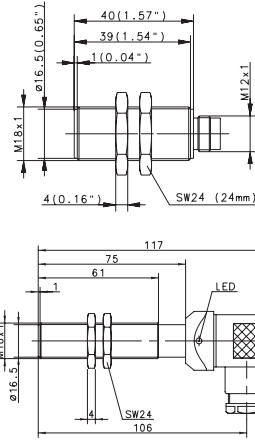
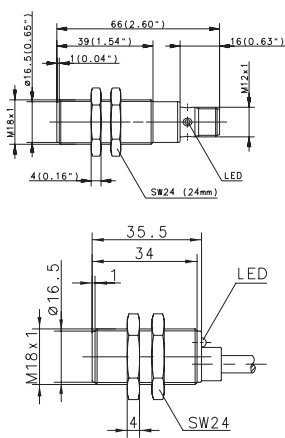

<b>6932905004</b> KIB-M18PS/005-KLS12	<b>6502905013</b> KIB-M18PS/005-KL6V	<b>6502905012</b> KIB-M18PS/005-KS12V <b>6502705007</b> KIB-M18PÖ/005-KS12V	<b>6602905662</b> KIB-M18PS/005-KLSD <b>6502705001</b> KIB-M18PÖ/005-KLSD	<b>6502940001</b> KIB-M18PS/005-KLSDV  <b>6502840002</b> KIB-M18PU/005-KSDV	<b>6502920990</b> KIB-T18PS/005-KL2		
<b>6932305004</b> KIB-M18NS/005-KLS12							<b>6503520697</b> KIB-T18AS/005-L2

10–36 VDC ≤ 200 mA 500 Hz Cyclic LED/–	10–60 VDC ≤ 200 mA 500 Hz Cyclic LED/–	10–60 VDC ≤ 200 mA 500 Hz Cyclic –/–	10–60 VDC ≤ 200 mA 500 Hz – LED/–	10–60 VDC ≤ 200 mA 500 Hz Cyclic LED/–	10–60 VDC ≤ 200 mA 500 Hz Cyclic –/–	10–60 VDC ≤ 200 mA 500 Hz Cyclic LED/–	24–250 V AC ≤ 200 mA ≈ 10 Hz – LED/–
--	--	--	---	--	--	--	--

–25°C/+70°C IP67 CuZn39Pb3 M12 x 1	–25°C/+70°C IP67 CuZn39Pb3 3 x 0.5 mm <sup>2</sup>	–25°C/+70°C IP67 CuZn39Pb3 M12 x 1	–25°C/+70°C IP65 CuZn39Pb3 DIN 43650	–25°C/+70°C IP65 CuZn39Pb3 DIN 43650	–25°C/+70°C IP65 CuZn39Pb3 DIN 43650	–25°C/+70°C IP67 PA, red 3 x 0.5 mm <sup>2</sup>	–25°C/+70°C IP67 PA, red 2 x 0.5 mm <sup>2</sup>
---	---	---	---	---	---	---	---

You will find detailed data sheets to the products under [www.bernstein.eu](http://www.bernstein.eu)



# Inductive Sensors (Type M18)

Type	M18		M18		M18	
Type of installation	Flush	Flush	Flush	Flush	Flush	Flush
Nominal sensing distance	5 mm	5 mm	5 mm	8 mm	8 mm	8 mm
Type of connection	Connector M12	Cable 2 m	Cable 2 m	Cable 2 m	Connector M12	Connector M12
Special feature	Temperature	Temperature	NAMUR	Sensing dist.	Sensing dist.	Sensing dist.

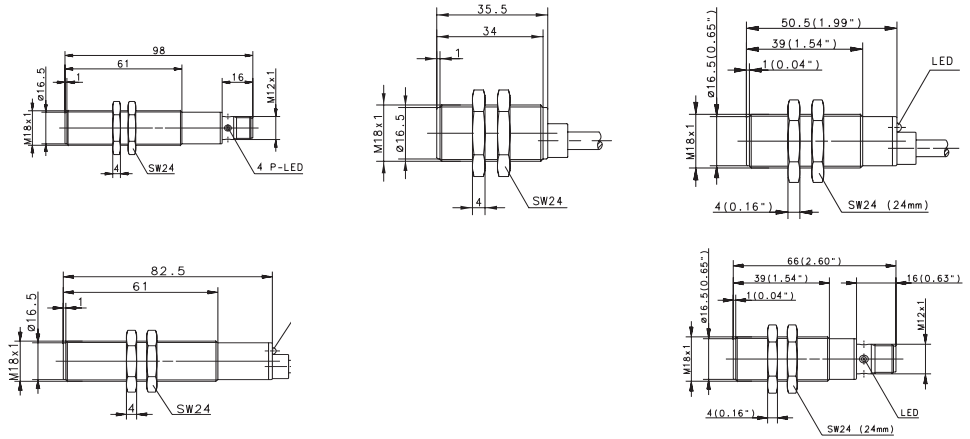

<b>PNP</b>	DC	NO contact Type NC contact Type Antivalent NO/NC Type	<b>6502940006</b> KIB-M18PS/005-KLS12T	<b>6502905023</b> KIB-M18PS/005-KL2PUT		<b>6502905022</b> KIB-M18PS/008-KL2E	<b>6502940005</b> KIB-M18PS/008-KLS12E
	DC	NO contact Type NC contact Antivalent NO/NC Type					
<b>NPN</b>	DC	NO contact Type NC contact Antivalent NO/NC Type					
<b>PNP/NPN</b>	DC	NO/NC prog. push-pull operation					
<b>NAMUR</b>	DC	Type			<b>6501626762</b> KIB-M18EA/005-2		
<b>Analogue</b>	DC						
	DC	NO contact NC contact					
<b>2-wire</b>	AC	NO contact Type NC contact Type Changeover contact					

### Technical data

Rated operating voltage	$U_B$	10–30 VDC	10–30 VDC	5–25 VDC	10–36 VDC	10–36 VDC
Rated operating current	$I_B$	$\leq 200$ mA	$\leq 200$ mA	–	$\leq 200$ mA	$\leq 200$ mA
Switching frequency (max)	F	500 Hz	500 Hz	$\leq 400$ Hz	500 Hz	500 Hz
Short circuit-protection		Cyclic	Cyclic	–	Cyclic	Cyclic
Function/operating voltage indicator		LED/–	LED/–	–/–	LED/–	LED/–
Sensing distance, adjustable						

### Mechanical data

Ambient temperature (min/max)		–40°C/+100°	–40°C/+100°	–25°C/+70°C	–25°C/+70°C	–25°C/+70°C
Protection class in accordance with IEC 529, EN 60529		IP67	IP67	IP67	IP67	IP67
Enclosure material		CuZn39Pb3	CuZn39Pb3	CuZn39Pb3	CuZn39Pb3	CuZn39Pb3
Connection		M12 x 1	3 x 0.5 mm <sup>2</sup>	2 x 0.5 mm <sup>2</sup>	3 x 0.5 mm <sup>2</sup>	M12 x 1

Please refer to Accessories for cable couplers, mounting brackets and sensor tester.







# Inductive Sensors (Type M18)

Type	M18		M18		M18
Type of installation	Non-flush	Non-flush	Non-flush	Non-flush	Non-flush
Nominal sensing distance	8 mm	8 mm	8 mm	8 mm	8 mm
Type of connection	Cable 2 m	Connector M12	Cable 2 m	Cable 2 m	Cable 2 m
Special feature	Plastic			Plastic	

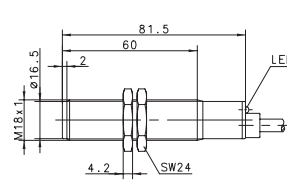
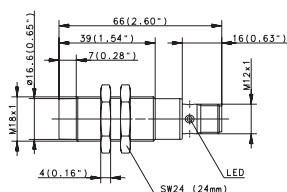
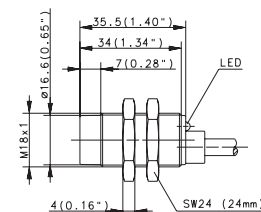
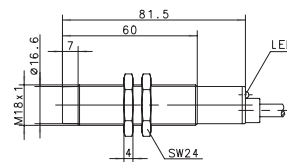
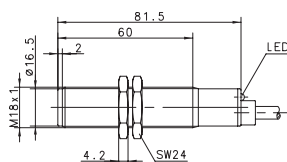

<b>PNP</b>	DC	NO contact Type NC contact Type Antivalent NO/NC Type	<b>6932906004</b> KIN-M18PS/008-KLS12 <b>6932706002</b> KIN-M18PÖ/008-KLS12	<b>6502921975</b> KIN-T18PS/008-KL2	<b>6502906006</b> KIN-M18PS/008-KL2V <b>6502706002</b> KIN-M18PÖ/008-KL2V
<b>NPN</b>	DC	NO contact Type NC contact Antivalent NO/NC	<b>6932306004</b> KIN-M18NS/008-KLS12		<b>6502306004</b> KIN-M18NS/008-KL2V
<b>PNP/NPN</b>	DC	NO/NC prog. push-pull operation			
<b>NAMUR</b>	DC				
<b>Analogue</b>	DC	Type			
<b>2-wire</b>	DC	NO contact NC contact Type	<b>6503521705</b> KIN-T18AS/008-L2 <b>6503421704</b> KIN-T18AÖ/008-L2	<b>6501306001</b> KIN-M18ZS/008-L2	
	AC	NO contact Type NC contact Type Changeover contact			

## Technical data

Rated operating voltage	$U_B$	24–250 V AC	10–36 VDC	10–60 VDC	10–60 VDC	10–60 VDC
Rated operating current	$I_B$	$\leq 200$ mA	$\leq 200$ mA	$\leq 200$ mA	$\leq 200$ mA	$\leq 200$ mA
Switching frequency (max)	F	$\approx 10$ Hz	200 Hz	200 Hz	200 Hz	200 Hz
Short circuit-protection		–	Cyclic	–	Cyclic	Cyclic
Function/operating voltage indicator		LED/–	LED/–	LED/–	LED/–	LED/–
Sensing distance, adjustable						

## Mechanical data

Ambient temperature (min/max)		–25°C/+70°C	–25°C/+70°C	–25°C/+70°C	–25°C/+70°C	–25°C/+70°C
Protection class in accordance with IEC 529, EN 60529		IP67	IP67	IP67	IP67	IP67
Enclosure material		PA, red	CuZn39Pb3	CuZn39Pb3	PA, red	CuZn39Pb3
Connection		2 x 0.5 mm <sup>2</sup>	M12 x 1	2 x 0.5 mm <sup>2</sup>	3 x 0.5 mm <sup>2</sup>	3 x 0.5 mm <sup>2</sup>

Please refer to Accessories for cable couplers, mounting brackets and sensor tester.



<b>M18</b>	<b>M18</b>	<b>M18</b>			
Non-flush 8 mm DIN Connector	Non-flush 8 mm DIN Connector	Non-flush 8 mm Connector M12 Ultralock	Non-flush 8 mm Cable 2 m	Non-flush 8 mm Connector M12	

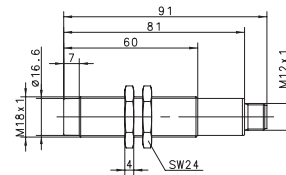
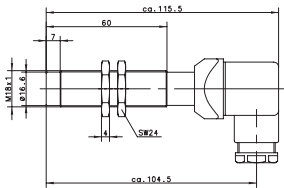
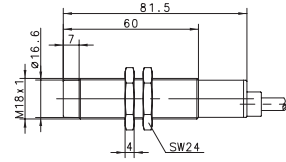
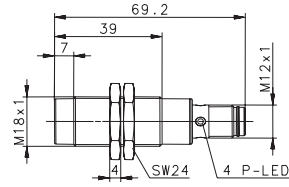
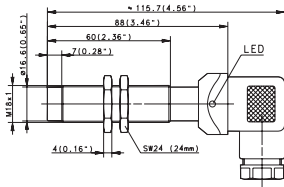

<b>6502941001</b> KIN-M18PS/008-KLSD					
<b>6502741001</b> KIN-M18PÖ/008-KLSD	<b>6602841421</b> KIN-M18PU/008-KSD				
		<b>6502306011</b> KIN-M18NS/008-KLS12U			
			<b>6502006001</b> KIN-M18PA/008-2	<b>6602006111</b> KIN-M18PA/008-S12	

10–60 VDC	10–60 VDC	10–36 VDC	10–36 VDC	10–36 VDC	
≤ 200 mA	≤ 200 mA	≤ 200 mA	–	–	
200 Hz	200 Hz	200 Hz	–	–	
Cyclic	–	Cyclic	Cyclic	–	
LED/–	–/–	LED/–	–/–	–/–	

–25°C/+70°C	–40°C/+80°C	–25°C/+70°C	–25°C/+70°C	–25°C/+70°C	
IP65	IP65	IP67	IP67	IP67	
CuZn39Pb3	CuZn39Pb3	CuZn39Pb3	CuZn39Pb3	CuZn39Pb3	
DIN 43650	DIN 43650	M12 x 1	3 x 0.5 mm <sup>2</sup>	M12 x 1	

You will find detailed data sheets to the products under [www.bernstein.eu](http://www.bernstein.eu)



# Inductive Sensors (Type M18, M30)

Type	M18		M30		M30	
Type of installation	Non-flush	Non-flush	Flush	Flush	Flush	Flush
Nominal sensing distance	16 mm	16 mm	10 mm	10 mm	10 mm	10 mm
Type of connection	Cable 2 m	Connector M12	Cable 2 m	Cable 2 m	Connector M12	Cable 2 m
Special feature	Sensing dist.	Sensing dist.				

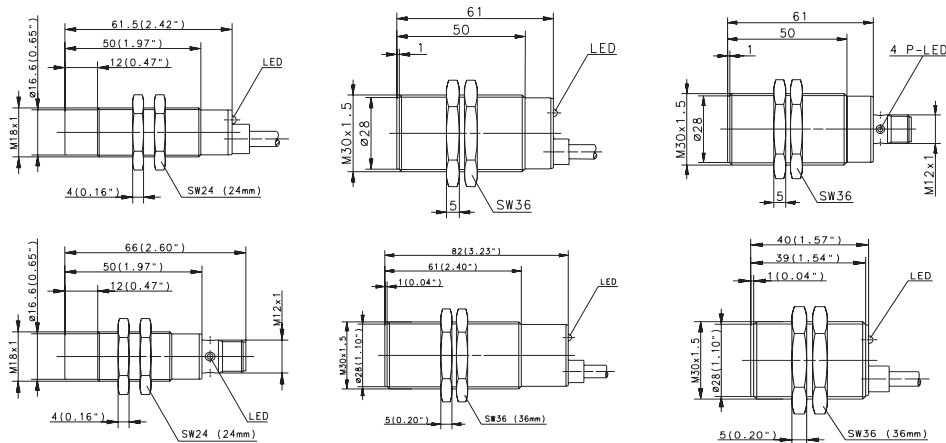

<b>PNP</b>	DC	NO contact Type NC contact Type Antivalent NO/NC	<b>6502906018</b> KIN-M18PS/016-KL2E	<b>6502941004</b> KIN-M18PS/016-KLS12E	<b>6932907001</b> KIN-M18PS/016-KLS12E	<b>6932907002</b> KIB-M30PS/010-KLS12	<b>6502907003</b> KIB-M30PS/010-KL2V <b>6502707001</b> KIB-M30PÖ/010-KL2V
<b>NPN</b>	DC	NO contact Type NC contact Antivalent NO/NC					
<b>PNP/NPN</b>	DC	NO/NC prog. Type push-pull operation					
<b>NAMUR</b>	DC						
<b>Analogue</b>	DC	Type					
<b>2-wire</b>	DC	NO contact NC contact Type					
	AC	NO contact Type NC contact Type Changeover contact				<b>6503507378</b> KIB-M30AS/010-L2 <b>6503407240</b> KIB-M30AÖ/010-L2	

## Technical data

Rated operating voltage	$U_B$	10–36 VDC	10–36 VDC	10–36 VDC	20–250 V AC	10–36 VDC	10–60 VDC
Rated operating current	$I_B$	≤ 200 mA	≤ 200 mA	≤ 200 mA	≤ 400 mA	≤ 200 mA	≤ 200 mA
Switching frequency (max)	F	200 Hz	200 Hz	300 Hz	≈ 10 Hz	300 Hz	300 Hz
Short circuit-protection		Cyclic	Cyclic	Cyclic	–	Cyclic	Cyclic
Function/operating voltage indicator		LED/–	LED/–	LED/–	LED/–	LED/–	LED/–
Sensing distance, adjustable							

## Mechanical data

Ambient temperature (min/max)		–25°C/+70°C	–25°C/+70°C	–25°C/+70°C	–25°C/+70°C	–25°C/+70°C	–25°C/+70°C
Protection class in accordance with IEC 529, EN 60529		IP67	IP67	IP67	IP67	IP67	IP67
Enclosure material		CuZn39Pb3	CuZn39Pb3	CuZn39Pb3	CuZn39Pb3	CuZn39Pb3	CuZn39Pb3
Connection		3 x 0.5 mm <sup>2</sup>	M12 x 1	3 x 0.5 mm <sup>2</sup>	2 x 0.5 mm <sup>2</sup>	M12 x 1	3 x 0.5 mm <sup>2</sup>

Please refer to Accessories for cable couplers, mounting brackets and sensor tester.





# Inductive Sensors (Type M30)

Type	M30	M30	M30	M30	
Type of installation	Flush	Non-flush	Non-flush	Non-flush	Non-flush
Nominal sensing distance	10 mm	15 mm	15 mm	15 mm	15 mm
Type of connection	Cable 2 m	Cable 2 m	Cable 2 m	Cable 2.5 m	Connector M12
Special feature	NAMUR				

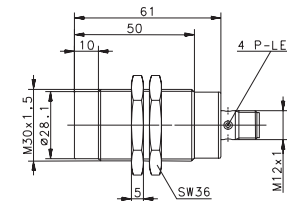
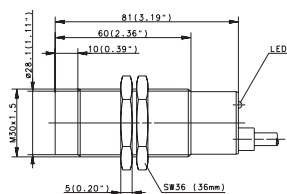
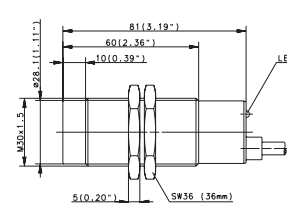
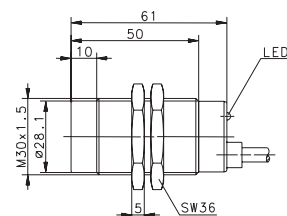
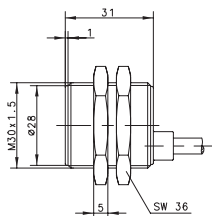

<b>PNP</b>	DC	NO contact Type NC contact Type Antivalent NO/NC Type		<b>6932908001</b> KIN-M30PS/015-KL2	<b>6502908002</b> KIN-M30PS/015-KL2		<b>6932908002</b> KIN-M30PS/015-KLS12 <b>6602308459</b> KIN-M30NS/015-KLS12
<b>NPN</b>	DC	NO contact Type NC contact Type Antivalent NO/NC			<b>6502808001</b> KIN-M30PU/015-KL2		
<b>PNP/NPN</b>	DC	NO/NC prog. Type push-pull operation			<b>6502308001</b> KIN-M30NS/015-KL2		
<b>NAMUR</b>	DC	Type	<b>6501699012</b> KIB-M30EA/010-2				
<b>Analogue</b>	DC	Type					
<b>2-wire</b>	DC	NO contact NC contact					
	AC	NO contact Type NC contact Changeover contact				<b>6503508246</b> KIN-M30AS/015-L2,5	

## Technical data

Rated operating voltage	$U_B$	5–25 VDC	10–36 VDC	10–60 VDC	20–250 V AC	10–36 VDC
Rated operating current	$I_B$	–	≤ 200 mA	≤ 200 mA	≤ 400 mA	≤ 200 mA
Switching frequency (max)	F	≤ 300 Hz	100 Hz	100 Hz	≈ 10 Hz	100 Hz
Short circuit-protection		–	Cyclic	Cyclic	–	Cyclic
Function/operating voltage indicator		–/–	LED/–	LED/–	LED/–	LED/–
Sensing distance, adjustable						

## Mechanical data

Ambient temperature (min/max)		–25°C/+70°C	–25°C/+70°C	–25°C/+70°C	–25°C/+70°C	–25°C/+70°C
Protection class in accordance with IEC 529, EN 60529		IP67	IP67	IP67	IP67	IP67
Enclosure material		CuZn39Pb3	CuZn39Pb3	CuZn39Pb3	CuZn39Pb3	CuZn39Pb3
Connection		2 x 0.5 mm <sup>2</sup>	3 x 0.5 mm <sup>2</sup>	3 x 0.5 mm <sup>2</sup>	2 x 0.5 mm <sup>2</sup>	M12 x 1

Please refer to Accessories for cable couplers, mounting brackets and sensor tester.



M30		M30		M30		M30	
Non-flush 15 mm	Non-flush 15 mm	Non-flush 15 mm	Non-flush 15 mm	Non-flush 15 mm	Non-flush 40 mm	Cable 2 m	Sensing dist.
Cable 2 m	Cable 2.5 m	DIN Connector	DIN Connector	Connector M12			
Plastic	Plastic	Plastic		Analogue			

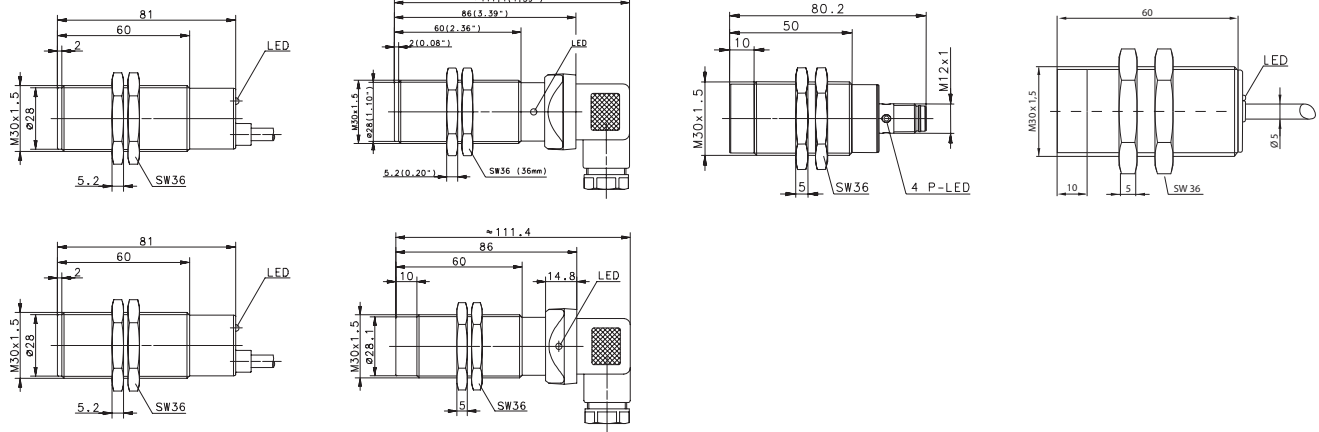

<b>6502923981</b> KIN-T30PS/015-KL2		<b>6502935001</b> KIN-M30PS/015-KLSD		<b>6502908009</b> KIN-M30PS/040-KL2E	
	<b>6502836860</b> KIN-T30PP/015-KLSD				
			<b>6502008001</b> KIN-M30PA/015-2		
<b>6503523956</b> KIN-T30AS/015-L2,5					

10–60 VDC	20–250 V AC	10–60 VDC	10–60 VDC	10–36 VDC	10–30 VDC
≤ 200 mA	≤ 400 mA	≤ 200 mA	≤ 200 mA	≤ 200 mA	≤ 200 mA
100 Hz	≈ 10 Hz	100 Hz	100 Hz	100 Hz	≤ 100 Hz
Cyclic	–	Cyclic	Cyclic	Cyclic	Cyclic
LED/–	LED/–	LED/–	LED/–	LED/–	LED/–

–25°C/+70°C	–25°C/+70°C	–25°C/+70°C	–25°C/+70°C	–25°C/+70°C	–25°C/+70°C
IP67	IP67	IP65	IP65	IP67	IP67
PA, red	PA, red	PA, red	CuZn39Pb3	CuZn39Pb3	CuZn39Pb3
3 x 0.5 mm <sup>2</sup>	2 x 0.5 mm <sup>2</sup>	DIN 43650	DIN 43650	M12 x 1	3 x 0.34 mm <sup>2</sup>

You will find detailed data sheets to the products under [www.bernstein.eu](http://www.bernstein.eu)



# Inductive Sensors (Type Ø 34 mm, 5 x 5, 8 x 8, 12 x 12, 27 x 10, 28 x 16)

Type	Ø 34 mm	5 x 5 x 25 mm	8 x 8 x 40 mm		8 x 8 x 56 mm
Type of installation	Non-flush	Flush	Flush	Flush	Flush
Nominal sensing distance	20.0 mm	1.5 mm	1.5 mm	1.5 mm	1.5 mm
Type of connection	Cable 2 m	Cable	Cable 2 m	Cable 2 m	Connector M8
Special feature					

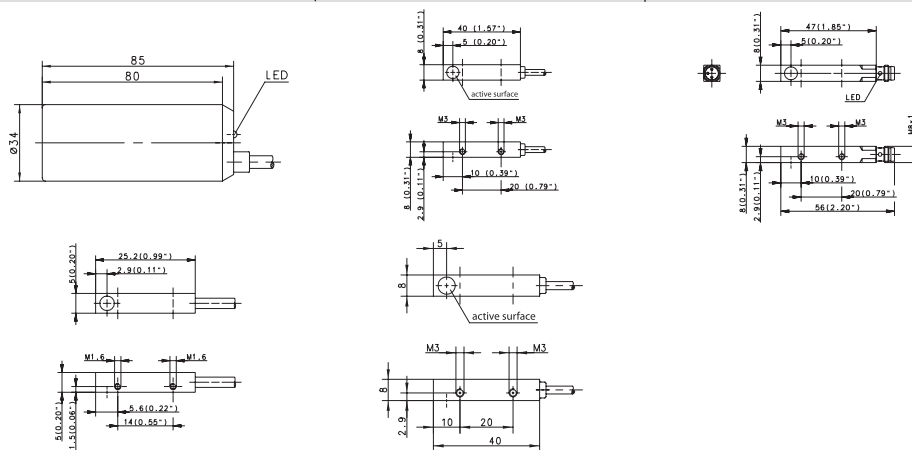

<b>PNP</b>	DC	NO contact Type NC contact Type Antivalent NO/NC	<b>6502915002</b> KIN-R34PS/020-KL2	<b>6502999026</b> KIB-Q05PS/001-K2PU <b>6502799010</b> KIB-Q05PÖ/001-K2PU	<b>6502980004</b> KIB-Q08PS/1,5-K2 <b>6502780001</b> KIB-Q08PÖ/1,5-K2	<b>6602980087</b> KIB-Q08PS/1,5-K2T	<b>6502980002</b> KIB-Q08PS/1,5-KLSM8 <b>6502780002</b> KIB-Q08PÖ/1,5-KLSM8
<b>NPN</b>	DC	NO contact Type NC contact Type Antivalent NO/NC					
<b>PNP/NPN</b>	DC	NO/NC prog. Type push-pull operation	<b>6502915001</b> KIN-R34PP/020-KLSD				
<b>NAMUR</b>	DC						
<b>Analogue</b>	DC						
<b>2-wire</b>	DC	NO contact NC contact					
	AC	NO contact NC contact Changeover contact					

## Technical data

Rated operating voltage	$U_B$	10–60 VDC	10–30 VDC	10–36 VDC	10–36 VDC	10–36 VDC
Rated operating current	$I_B$	≤ 200 mA	200 mA	≤ 200 mA	≤ 200 mA	≤ 200 mA
Switching frequency (max)	F	100 Hz	1000 Hz	1000 Hz	1000 Hz	1000 Hz
Short circuit-protection		Cyclic	Cyclic	Cyclic	Cyclic	Cyclic
Function/operating voltage indicator		LED/-	-/-	-/-	-/-	LED/-
Sensing distance, adjustable						

## Mechanical data

Ambient temperature (min/max)		-25°C/+70°C	-25°C/+70°C	-25°C/+70°C	0°C/+100°C	-25°C/+70°C
Protection class in accordance with IEC 529, EN 60529		IP67	IP67	IP67	IP67	IP67
Enclosure material		PBT, red	CuZn39PB3	CuZn39PB3	CuZn39PB3	CuZn39PB3
Connection		3 x 0.5 mm <sup>2</sup>	3 x 0.05 mm <sup>2</sup>	3 x 0.14 mm <sup>2</sup>	3 x 0.14 mm <sup>2</sup>	M8 x 1

Please refer to Accessories for cable couplers, mounting brackets and sensor tester.







# Inductive Sensors (Type 28 x 16 mm, 40 x 26 mm, 50 x 25 mm, 60 x 36 mm)

Type	40 x 26 x 12 mm	40 x 26 x 12 mm	40 x 26 x 12 mm	40 x 26 x 12 mm	40 x 26 x 12 mm
Type of installation	Flush	Flush	Non-flush	Non-flush	Non-flush
Nominal sensing distance	2 mm	2 mm	4 mm	4 mm	4 mm
Type of connection	Cable 2 m	Connector M8	Cable 2 m	Cable 2 m	Connector M8
Special feature					

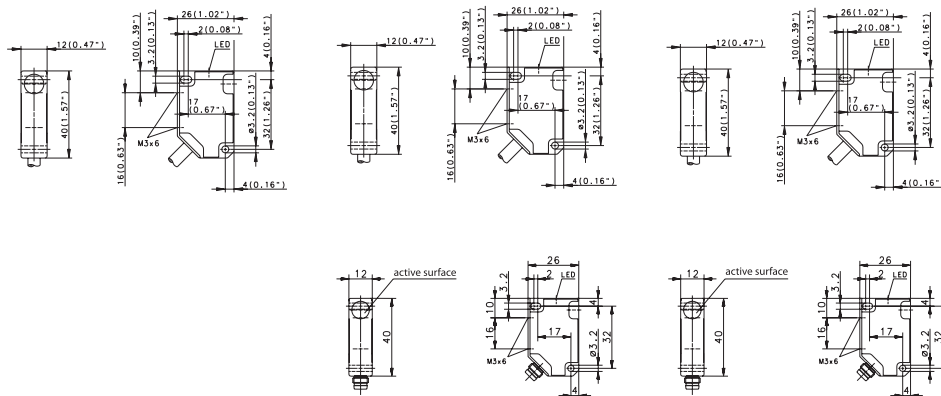

<b>PNP</b>	DC	NO contact Type NC contact Type Antivalent NO/NC Type	<b>6502984023</b> KIB-E40PS/002-KL2 <b>6502784006</b> KIB-E40PÖ/002-KL2	<b>6502984025</b> KIB-E40PS/002-KLSM8	<b>6502984024</b> KIN-E40PS/004-KL2 <b>6502784007</b> KIN-E40PÖ/004-KL2	<b>6502984026</b> KIN-E40PS/004-KLSM8 <b>6502784008</b> KIN-E40PÖ/004-KLSM8
<b>NPN</b>	DC	NO contact Type NC contact Type Antivalent NO/NC				
<b>PNP/NPN</b>	DC	NO/NC prog. Type push-pull operation				
<b>NAMUR</b>	DC	Type				
<b>Analogue</b>	DC	Type				
<b>2-wire</b>	DC	NO contact NC contact				
	AC	NO contact Type NC contact Changeover contact				<b>6503584005</b> KIN-E40AS/004-L2

## Technical data

Rated operating voltage	$U_B$	10–36 VDC	10–36 VDC	10–36 VDC	20–250 V AC	10–36 VDC
Rated operating current	$I_B$	≤ 200 mA	≤ 200 mA	≤ 200 mA	≤ 300 mA	≤ 200 mA
Switching frequency (max)	F	800 Hz	800 Hz	400 Hz	10 Hz	400 Hz
Short circuit-protection		Cyclic	Cyclic	Cyclic	–	Cyclic
Function/operating voltage indicator		LED/–	LED/–	LED/–	LED/–	LED/–
Sensing distance, adjustable						

## Mechanical data

Ambient temperature (min/max)		–25°C/+70°C	–25°C/+70°C	–25°C/+70°C	–25°C/+70°C	–25°C/+70°C
Protection class in accordance with IEC 529, EN 60529		IP67	IP67	IP67	IP67	IP67
Enclosure material		PBT, black	PBT, black	PBT, black	PBT, black	PBT, black
Connection		3 x 0.5 mm <sup>2</sup>	M8 x 1	3 x 0.5 mm <sup>2</sup>	2 x 0.5 mm <sup>2</sup>	M8 x 1

Please refer to Accessories for cable couplers, mounting brackets and sensor tester.



50 x 25 x 10 mm		50 x 25 x 10 mm		60 x 36 x 10 mm	
Flush	Flush	Non-flush	Non-flush	Non-flush	
5 mm	5 mm	8 mm	8 mm	8 mm	
Cable 2 m	Connector M8	Cable 2 m	Connector M8	Connector M8	

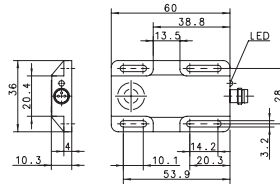
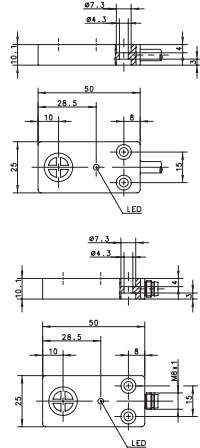
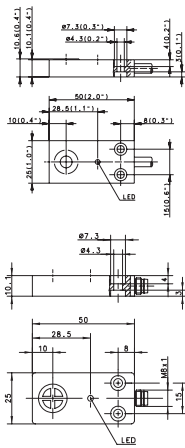

<b>6502990001</b> KIB-E50PS/005-KL2	<b>6502990005</b> KIB-E50PS/005-KLSM8	<b>6502990003</b> KIN-E50PS/008-KL2	<b>6502990006</b> KIN-E50PS/008-KLSM8	<b>6602799048</b> KIN-E60PÖ/008-KLSM8		
<b>6502390001</b> KIB-E50NS/005-KL2		<b>6502390002</b> KIN-E50NS/008-KL2				

10–60 VDC	10–60 VDC	10–60 VDC	10–60 VDC	10–60 VDC
≤ 200 mA	≤ 200 mA	≤ 200 mA	≤ 200 mA	≤ 400 mA
500 Hz	500 Hz	200 Hz	200 Hz	200 Hz
Cyclic	Cyclic	Cyclic	Cyclic	Cyclic
LED/–	LED/–	LED/–	LED/–	LED/–

–25°C/+70°C	–25°C/+70°C	–25°C/+70°C	–25°C/+70°C	–25°C/+70°C
IP67	IP67	IP67	IP67	IP67
PA, black	PA, black	PA, black	PA, black	PA, black
3 x 0.5 mm <sup>2</sup>	M8 x 1	3 x 0.5 mm <sup>2</sup>	M8 x 1	M8 x 1

You will find detailed data sheets to the products under [www.bernstein.eu](http://www.bernstein.eu)



## Inductive Sensors (Type 68 x 30 mm, 40 x 40 mm)

Type	68 x 30 x 15 mm	40 x 40 mm	40 x 40 mm	
Type of installation	Non-flush	Non-flush	Non-flush	Non-flush
Nominal sensing distance	7 mm	20 mm	15 mm	0 mm
Type of connection	Cable 2 m	Connector M12	DIN Connector	Cable 6 m
Special feature				Ring sensor

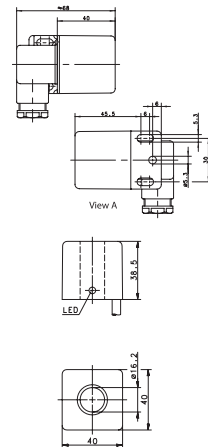
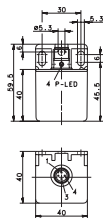
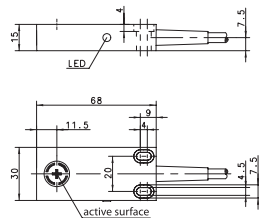

<b>PNP</b>	DC	NO contact Type NC contact Type Antivalent NO/NC	<b>6502956076</b> KIN-E68PS/007-KL2	<b>6502982003</b> KIN-N40PS/020-KLS12	<b>6502999036</b> KIR-N40PS/000-KL6
<b>NPN</b>	DC	NO contact Type NC contact Type Antivalent NO/NC	<b>6502156058</b> KIN-E68NÖ/007-KL6		
<b>PNP/NPN</b>	DC	NO/NC prog. Type push-pull operation			<b>6502982001</b> KIN-N40PP/015-KLSD
<b>NAMUR</b>	DC				
<b>Analogue</b>	DC				
<b>2-wire</b>	DC	NO contact NC contact			
	AC	NO contact NC contact Changeover contact			

### Technical data

Rated operating voltage	$U_B$	10–60 VDC	10–36 VDC	10–60 VDC	10–30 VDC
Rated operating current	$I_B$	≤ 200 mA	≤ 200 mA	≤ 400 mA	≤ 200 mA
Switching frequency (max)	F	200 Hz	50 Hz	100 Hz	–
Short circuit-protection		Cyclic	Cyclic	Cyclic	Cyclic
Function/operating voltage indicator		LED/–	LED/–	LED/–	LED/–
Sensing distance, adjustable					

### Mechanical data

Ambient temperature (min/max)		–25°C/+70°C	–25°C/+70°C	–25°C/+70°C	–25°C/+70°C
Protection class in accordance with IEC 529, EN 60529		IP67	IP67	IP65	IP67
Enclosure material		PBT, black	PA, red/black	PA, red	PA, black
Connection		3 x 0.5 mm <sup>2</sup>	M12 x 1	DIN 43650	3 x 0.5 mm <sup>2</sup>

Please refer to Accessories for cable couplers, mounting brackets and sensor tester.





# Capacitive Sensors

## Functional principle

Capacitive proximity switches detect conductive and non-conductive materials that can be in a solid or liquid state. They serve the purpose of monitoring product levels in containers, checking contents in filling and packaging systems as well as detecting, positioning, monitoring and counting objects, e.g. in sequence control systems, conveyor belts.

Used for detecting media such as:

- **solid:**  
wood, ceramic, glass, paper stacks, plastic, stone, rubber, ice, nonferrous metals, potatoes
- **liquid:**  
water, oil, beverages, adhesives, paints
- **granular:**  
plastic pellets, granulated products, grain, fodder, wood chip
- **powder:**  
dyes, detergents, sand, cement, fertilizer, salt, sugar, flour, coffee

## Technical description

The function of the capacitive proximity switch is based on evaluating the influence exerted by an actuator on the electrical field at the active face of the switch. The approach of an influencing object increases the capacitance of the capacitor, which consists of a sensor electrode located behind the active face and the actuator connected to earth / mass. This increase in capacitance is dependent on the conductance and the dielectric constant of the actuator as well as its mass, surface area and its distance from the sensor electrode. The capacitive limit switch is equipped with an RC oscillator with a gain factor that increases as a result of the rise in capacitance of the previously described capacitor to such an extent that oscillation is induced. In limit switches, the capacitance required to induce oscillation can be determined by the built-in potentiometer intervening in the feedback of the oscillator.

The response sensitivity, i.e. the sensing distance with a given actuator can be adjusted in this way. The oscillator output signal is fed to an evaluation circuit that actuates the switching amplifier.

In response to the approach of **conductive** material the actuating object and the active face of the sensor form the plates of a capacitor. The change in capacitance and the consequently achievable sensing distance are large.

In response to the approach of **non-conductive** material  $\epsilon > 1$  only the change in the dielectric constant is effective. The increase in capacitance is less than is the case for conductive materials. The resulting sensing distance is small.

Sensitivity table	
St37 or other metals, earthed	1.00
Surface of water	1.00
St37 150 x 150 x 1 mm, not earthed	0.85
Marble 150 x 150 x 12.5 mm	0.65
Glass 150 x 150 x 7.5 mm	0.55
Stack of paper DIN A 4, 80 g/m <sup>2</sup> , 500 sheets	0.55
Fibre board 150 x 150 x 16 mm	0.45
Ceramic tile 150 x 150 x 6 mm	0.25
PVC 150 x 150 x 4 mm	0.15

These values only indicate the expected magnitude of the response sensitivity as the specific properties of the actuating object and of the surroundings in actual applications have a considerable influence on the response distance. It is important to take into account the influence of moisture in order to ensure trouble-free operation. A high water content in the material to be detected, e.g. wood or paper, increases the sensing distance considerably.

In terms of capacitive proximity switches a distinction is made between

- flush mount and
  - non-flush mount
- limit switches.

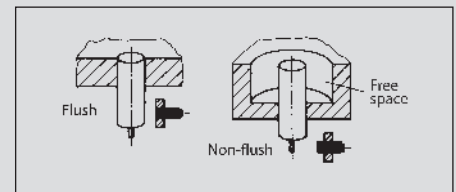

In the case of non-flush mount limit switches a clearance that must contain no influencing material must be created about the switch. Due to the adjustment facility available in capacitive proximity switches, the installation of non-flush mount devices is not problematic in connection with reduced clearance. Non-flush mount capacitive proximity switches are characterised by low sensitivity to soiling or condensation.

A screening electrode built into flush mount limit switches is connected to circuit ground. As both electrodes of the capacitor are now close together, flush mount capacitive proximity switches are particularly suitable for sensing dielectrics. The disadvantage is that this configuration has an increased sensitivity to condensation or soiling.

Capacitive proximity switches can mutually influence each other if they are mounted next to or opposite each other. In such configurations, the response of flush mount switches is considerably less sensitive than non-flush mount switches. Trials under actual application conditions should be carried out at distances from  $> 2x$  to  $< 8x$  enclosure diameter. Arrangements with distances  $> 8x$  enclosure diameter are not problematic.

**Active face:** The active face of a capacitive proximity switch is the point at which the electrical field emerges. This point is located at the end face on types designed as threaded sleeves or smooth cylinders. Non-cylindrical limit switches are identified by a symbol on the corresponding face.

**Influencing:** In relation to a capacitive proximity switch the term influencing refers to the change in the switching status in response to the medium to be detected entering the electrical field.

**Standard target:** The standard target is defined as a square plate, 1 mm thick and made from FE 360.

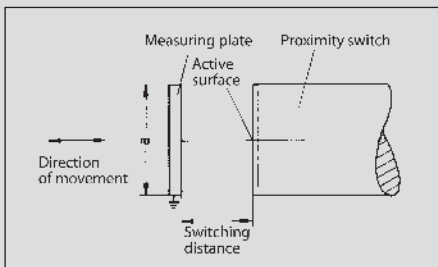

The side length "a" of the square target corresponds to the diameter of the circle described by the active face. The length of its side is defined as the larger of either the active face diameter or three times the nominal sensing distance. The target must be earthed in order to ensure comparable sensing distances. The sensing distance of rectangular, capacitive proximity switches is determined by means of an earthed target with a size equal to the surface of the active side of the limit switch.

**Sensing distance:** The sensing distance, that changes the status of the output stage, is the distance of the influencing object in relation to the active face.

**Nominal sensing distance ( $s_n$ ):** This is a device-specific characteristic value that does not take into account influences such as tolerance, temperature and changes in voltage.

**Real sensing distance ( $s_r$ ):** The real sensing distance is measured at a rated voltage and an ambient temperature of 23 °C +/- 5 °C. It must be between 90 % and 110 % of the nominal sensing distance.

**Useable sensing distance ( $s_u$ ):** The useable sensing distance is measured within the permissible temperature and voltage ranges and is 80 % – 120 % of the real sensing distance.

**Assured sensing distance ( $s_a$ ) (operational sensing distance):** This is the distance that can be used effectively under the influence of temperature, voltage as well as tolerance variables. It is between 0 % and 72 % of the nominal sensing distance.

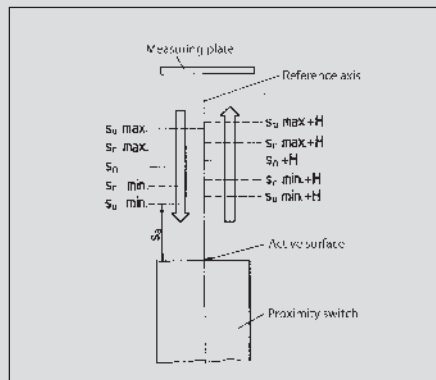

**Reproducibility:** The reproducibility of the switching distance is the repeat accuracy of the real sensing distance of two successive switching operations within a period of 8 hours at an ambient temperature between 18 °C and 28 °C and a supply voltage that may not deviate by more than 5 % from the rated voltage. The difference between any two measurements must not be more than 10 % of the real sensing distance.

**Switching hysteresis:** The switching hysteresis refers to the difference between the switch-on point as an object approaches the target and the switch-off point as the object moves away from the proximity switch. The value is specified as a percentage of the real sensing distance.

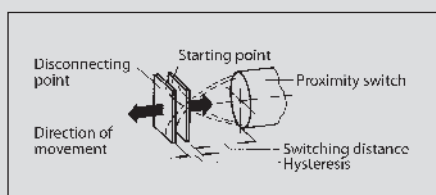

**Switching frequency:** The switching frequency is measured in accordance with EN 60947-5-2. The standard targets with the side length "a" are mounted on a plate that exerts minimum influence at "2a" intervals and are moved passed the proximity switch to be tested at half the nominal sensing distance. The maximum switching frequency is reached when the switch-on or switch-off time of the proximity switch is 50 µs. In the case of AC proximity switches, the maximum switching frequency is reached when the switch-on and switch-off time is equal to the half wave period of the supply frequency.

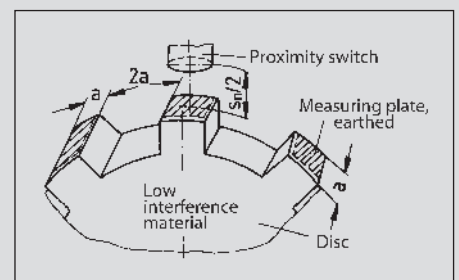

**Temperature range:** In accordance with DIN, the temperature range is from -25 °C to +70 °C. Reliable operation is ensured within this range.

#### Protection class

Corresponding to their ID code, the enclosures are dustproof and waterproof in accordance with IP65 or IP67 (DIN 40050).

#### Connection cable

A PVC-insulated connection cable is supplied as standard. Special versions with silicone sheathing, polyurethane sheathing, irradiation cross-linked PVC or Teflon insulation are also available.

#### Plug connection

Nowadays the plug connection is just as significant as the fixed cable on electronic proximity switches. The capacitive proximity switches in the BERNSTEIN range can be equipped with a wide variety of plug connections. As standard, this catalogue contains connector versions of virtually all types of limit switch.

#### Standards

All sensors conform to EN 60947-5-2



# Capacitive Sensors

## Important information

Capacitive sensors are able to detect conductive and non-conductive materials in solid, liquid, granular or powder form. However, certain criteria must be taken into account in practical applications.

## Sensing distance

The nominal sensing distances are specified and set at the factory in accordance with DIN EN 60947-5-2/98. The maximum sensing distance is achieved on approach of **conductive** materials of corresponding size.

On approach of **non-conductive** materials, the dielectric constant  $\epsilon$  of the material to be detected is of decisive significance. Depending on the application, the specified sensing distances vary by a certain factor in relation to the dielectric constant. The values determined according to the table only indicate the expected magnitude of the response sensitivity as the specific properties of the actuating object (diameter, thickness, moisture content etc.) and of the surroundings (earthing) in actual applications have a considerable influence on the response distance. In most cases adaptation to the specific application can be achieved by adjustment with the built-in potentiometer.

## Clearance

In the case of non-flush mount capacitive sensors a clearance that must contain no influencing material must be created about the sensor. Non-flush mount capacitive sensors are characterised by low sensitivity to soiling or condensation. On account of their design, flush mount capacitive sensors are particularly suitable for sensing dielectrics. The increased sensitivity, however, may be detrimental in terms of the above mentioned parasitic effects.

If capacitive proximity switches are to be mounted opposite or next to each other, trials under actual application conditions should be carried out at distances between 2x and 8x enclosure diameter. Thanks to the adjustment facility, however, adaptation to specific applications is almost always possible.

Examples of dielectric constants	
Glass	3 ... 14
Rubber	2.5 ... 3
Laminated paper	3.5 ... 6
Wood	2.5 ... 6.8
Marble	8.4 ... 14
Mineral oil	2.15
Epoxy resin	3.3 ... 3.6
Petroleum	2.2
Plexiglas	3.6
Polyamide	3 ... 8
PVC	3.3 ... 4.1
Porcelain	4.2 ... 6.5
Teflon PTFE	2
Air	1
Water	80.8
Paper (dry)	2

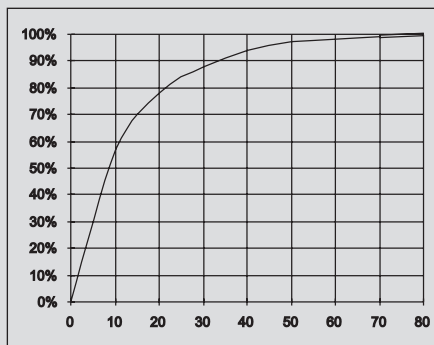

Variance of sensing distance as a function of  $\epsilon$







## Application descriptions

A particular application of capacitive proximity switches is to detect levels in non-metallic containers from the outside. Advantage: There is no need to make a hole in the container wall for the purpose of detecting product level. The medium to be detected does not come in contact with the limit switch. The prerequisite is that the dielectric constant and the mass of the material to be detected are greater than that of the container. The response sensitivity of the proximity switch must be reduced with the built-in potentiometer to such an extent that the limit switch does not respond to the container wall but rather to the medium to be detected.

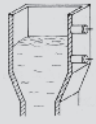
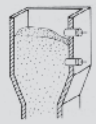
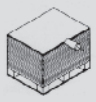

Above: Insulation glass production lines equipped with BERNSTEIN capacitive sensors

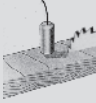
Further fields of application are illustrated below.

- 
Level monitoring in non-metallic containers
- 
Level monitoring of bulk material, e.g. granulated material, fodder
- 
Stack height scanning, e.g. paper, chip board
- 
Fill level monitoring in paint and adhesive containers
- 
Registering, counting, sorting or monitoring in conveyor belt systems
- 
Detecting, positioning in sequence control systems
- 
Detection in woodworking applications
- 
Belt breakage signalling
- 
Level monitoring in packing systems





# Capacitive Sensors (Type M12, M18)

Type	M12		M12		M12
Type of installation	Flush	Flush	Non-flush	Non-flush	Non-flush
Nominal sensing distance	2 mm	2 mm	4 mm	4 mm	6 mm
Type of connection	Cable 2 m	Connector M8	Cable 2 m	Connector M8	Cable 2 m
Special feature					Sensing dist.

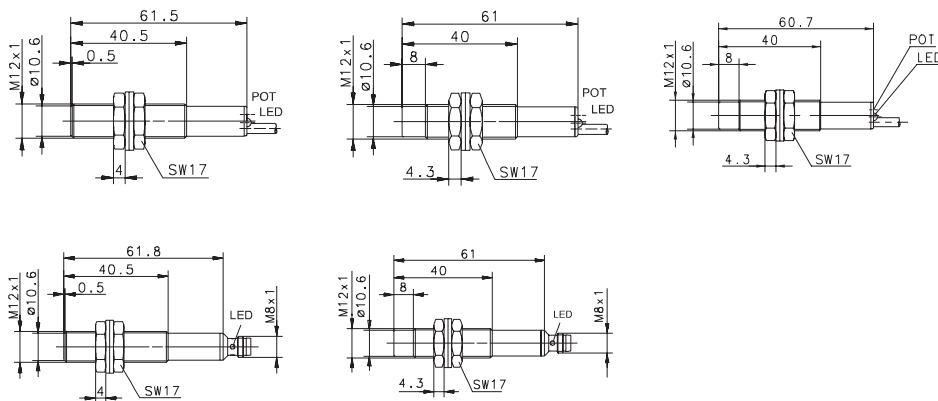

PNP	DC	NO contact	<b>6507903001</b>	<b>6507903004</b>	<b>6507919001</b>	<b>6507919004</b>	<b>6607919110</b>
		Type	KCB-M12PS/002-KLP2	KCB-M12PS/002-KLSM8	KCN-T12PS/004-KLP2	KCN-T12PS/004-KLSM8	
NPN	DC	NC contact	<b>6507703001</b>				
		Type	KCB-M12PÖ/002-KLP2				
PNP/NPN	DC	Antivalent NO/NC					
		Type					
NAMUR	DC	Antivalent NO/NC					
		Type					
Analogue	DC	NO/NC prog.					
		push-pull operation					
2-wire	DC	NO contact	<b>6507303001</b>		<b>6507319001</b>		
		NC contact	KCB-M12NS/002-KLP2		KCN-T12NS/004-KLP2		
2-wire	AC	NO contact					
		NC contact					
2-wire	AC	Changeover contact					
		Type					

### Technical data

Rated operating voltage	$U_B$	10–36 VDC	10–36 VDC	10–36 VDC	10–36 VDC	10–36 VDC
Rated operating current	$I_e$	≤ 200 mA	≤ 200 mA	≤ 200 mA	≤ 200 mA	≤ 200 mA
Switching frequency (max)	F	25 Hz	25 Hz	25 Hz	25 Hz	25 Hz
Short circuit-protection		Cyclic	Cyclic	Cyclic	Cyclic	Cyclic
Function/operating voltage indicator		LED/-	LED/-	LED/-	LED/-	LED/-
Sensing distance, adjustable		Poti	-	Poti	-	Poti

### Mechanical data

Ambient temperature (min/max)		-25°C/+70°C	-25°C/+70°C	-25°C/+70°C	-25°C/+70°C	-25°C/+70°C
Protection class in accordance with IEC 529, EN 60529		IP65	IP65	IP65	IP65	IP65
Enclosure material		CuZn39Pb3	CuZn39Pb3	PBT, black	PBT, black	PBT, black
Connection		3 x 0.14 mm <sup>2</sup>	M8 x 1	3 x 0.14 mm <sup>2</sup>	M8 x 1	3 x 0.14 mm <sup>2</sup>

Please refer to Accessories for cable couplers, mounting brackets and sensor tester.





# Capacitive Sensors (Type M30, M32)

Type	M30		M30		M30	
Type of installation	Flush	Flush	Non-flush	Non-flush	Non-flush	Non-flush
Nominal sensing distance	10 mm	10 mm	20 mm	20 mm	20 mm	20 mm
Type of connection	Cable 2 m	Connector M12	Cable 2 m	Connector M12	Connector M12	Cable 2 m
Special feature					Short form	

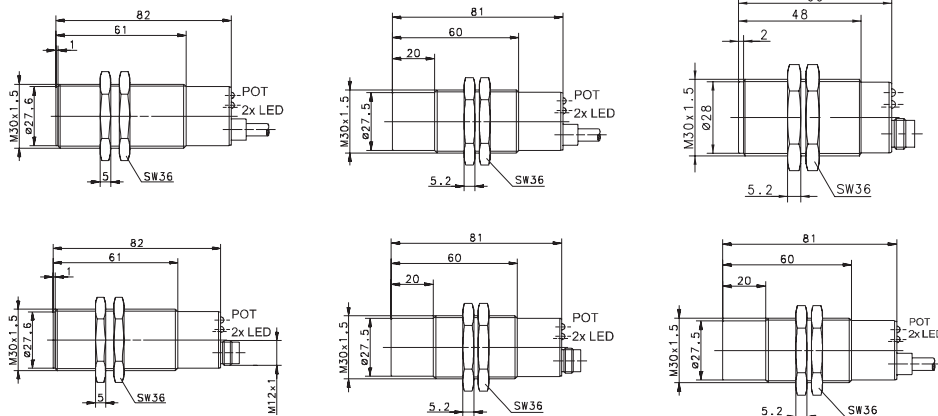

<b>PNP</b>	DC	NO contact Type NC contact Antivalent NO/NC Type	<b>6507907001</b> KCB-M30PS/010-KLP2	<b>6507907004</b> KCB-M30PS/010-KLPS12	<b>6507923727</b> KCN-T30PS/020-KLP2	<b>6507923004</b> KCN-T30PS/020-KLPS12	<b>6507923006</b> KCN-T30PS/020-KLPS12V
<b>NPN</b>	DC	NO contact Type NC contact Antivalent NO/NC Type	<b>6507707001</b> KCB-M30PÖ/010-KLP2		<b>6507323001</b> KCN-T30NS/020-KLP2		
<b>PNP/NPN</b>	DC	NO/NC prog. Type push-pull operation Type					
<b>NAMUR</b>	DC						
<b>Analogue</b>	DC						
<b>2-wire</b>	DC	NO contact NC contact					
	AC	NO contact Type NC contact Type Changeover contact Type					<b>6508523001</b> KCN-T30AS/020-LP2 <b>6508423001</b> KCN-T30AÖ/020-LP2

## Technical data

Rated operating voltage	$U_B$	10–60 VDC	10–60 VDC	10–60 VDC	10–60 VDC	10–60 VDC	20–250 V AC
Rated operating current	$I_o$	≤ 400 mA	≤ 400 mA	≤ 400 mA	≤ 400 mA	≤ 400 mA	≤ 300 mA
Switching frequency (max)	F	25 Hz	25 Hz	25 Hz	25 Hz	25 Hz	15 Hz
Short circuit-protection		Cyclic	Cyclic	Cyclic	Cyclic	Cyclic	–
Function/operating voltage indicator		LED/LED	LED/LED	LED/LED	LED/LED	LED/LED	LED/LED
Sensing distance, adjustable		Poti	Poti	Poti	Poti	Poti	Poti

## Mechanical data

Ambient temperature (min/max)		–25°C/+70°C	–25°C/+70°C	–25°C/+70°C	–25°C/+70°C	–25°C/+70°C	–25°C/+70°C
Protection class in accordance with IEC 529, EN 60529		IP65	IP65	IP65	IP65	IP65	IP65
Enclosure material		CuZn39Pb3	CuZn39Pb3	PBT, black	PBT, black	PBT, black	PBT, black
Connection		3 x 0.5 mm <sup>2</sup>	M12 x 1	3 x 0.5 mm <sup>2</sup>	M12 x 1	M12 x 1	2 x 0.5 mm <sup>2</sup>

Please refer to Accessories for cable couplers, mounting brackets and sensor tester.



M30	M30	M32		M32	
Non-flush 20 mm Cable 2 m PTFE front cap	Non-flush 20 mm Cable 2 m Timer/Relay	Flush 15 mm Cable 6 m	Flush 15 mm Connector M12	Non-flush 30 mm Cable 2 m	Non-flush 30 mm Connector M12

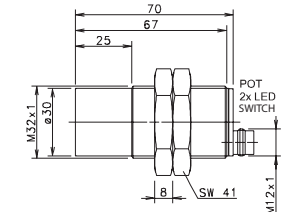
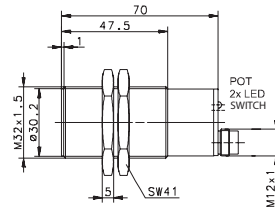
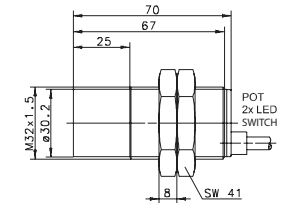
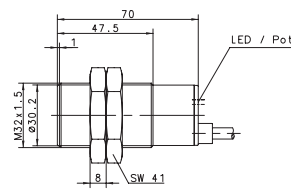
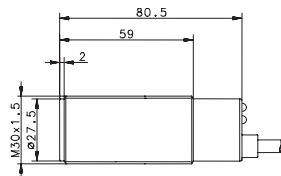
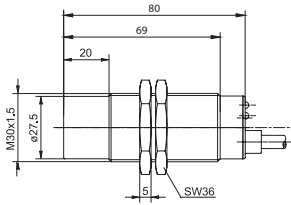

<b>6507908001</b> KCN-M30PS/020-KLP2					
<b>6507308001</b> KCN-M30NS/020-KLP2					
			<b>6507013013</b> KCB-M32DP/015-KLP6 <b>6507013012</b> KCB-M32GP/015-KLP2	<b>6507013015</b> KCB-M32DP/015-KLPS12	<b>6507013001</b> KCN-T32DP/030-KLP2 <b>6507013004</b> KCN-T32DP/030-KLPS12
		<b>6509023001</b> KCN-T30RU/020-LP2			

10–60 VDC ≤ 400 mA 25 Hz Cyclic LED/LED Poti	20–250 V AC ≤ 1 A – – LED/LED Poti	10–60 VDC ≤ 400 mA 25 Hz Cyclic LED/LED Poti	10–60 VDC ≤ 400 mA 25 Hz Cyclic LED/– Poti	10–60 VDC ≤ 400 mA 25 Hz Cyclic LED/– Poti	10–60 VDC ≤ 400 mA 25 Hz Cyclic LED/– Poti
---	---	---	---	---	---

–25°C/+70°C IP67 Stainless steel 1.4305 3 x 0,5 mm <sup>2</sup>	–25°C/+70°C IP67 PBT, black 5 x 0,5 mm <sup>2</sup>	–25°C/+70°C IP65 CuZn39Pb3 3 x 0.5 mm <sup>2</sup>	–25°C/+70°C IP65 CuZn39Pb3 M12 x 1	–25°C/+70°C IP65 PBT, black 3 x 0.5 mm <sup>2</sup>	–25°C/+70°C IP65 PBT, black M12 x 1
--	--	---	---	--	--

You will find detailed data sheets to the products under [www.bernstein.eu](http://www.bernstein.eu)



# Capacitive Sensors (Type M32, Ø 34 mm, E50, E68)

Type	M32	Ø 34 mm		Ø 34 mm	
Type of installation	Non-flush	Flush	Non-flush	Non-flush	Non-flush
Nominal sensing distance	30 mm	20 mm	30 mm	30 mm	30 mm
Type of connection	Cable 2 m	Connector M12	Cable 2 m	Connector M12	Cable 2 m
Special feature	Timer/Relay				

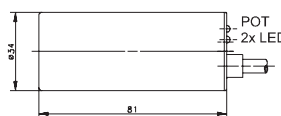
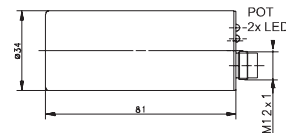
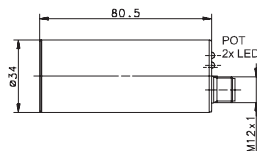
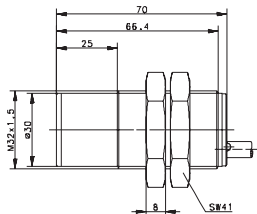

<b>PNP</b>	DC	NO contact Type NC contact Antivalent NO/NC		<b>6507915006</b> KCB-D34PS/020-KLPS12	<b>6507915001</b> KCN-R34PS/030-KLP2	<b>6507915004</b> KCN-R34PS/030-KLPS12	
<b>NPN</b>	DC	NO contact Type NC contact Antivalent NO/NC			<b>6507315001</b> KCN-R34NS/030-KLP2		
<b>PNP/NPN</b>	DC	NO/NC prog. push-pull operation					
<b>NAMUR</b>	DC						
<b>Analogue</b>	DC						
<b>2-wire</b>	DC	NO contact NC contact					
	AC	NO contact Type NC contact Type Changeover contact Type	<b>6508613001</b> KCN-T32RU/030-LP2				<b>6508515001</b> KCN-R34AS/030-LP2 <b>6508415001</b> KCN-R34AÖ/030-LP2

### Technical data

Rated operating voltage	$U_B$	180–250 V AC	10–60 VDC	10–60 VDC	10–60 VDC	20–250 V AC
Rated operating current	$I_e$	≤ 8 A	≤ 200 mA	≤ 400 mA	≤ 400 mA	≤ 300 mA
Switching frequency (max)	F	–	25 Hz	25 Hz	25 Hz	15 Hz
Short circuit-protection		–	Cyclic	Cyclic	Cyclic	–
Function/operating voltage indicator		LED/LED	LED/LED	LED/LED	LED/LED	LED/LED
Sensing distance, adjustable		Poti	Poti	Poti	Poti	Poti

### Mechanical data

Ambient temperature (min/max)		–25°C/+70°C	–25°C/+70°C	–25°C/+70°C	–25°C/+70°C	–25°C/+70°C
Protection class in accordance with IEC 529, EN 60529		IP65	IP65	IP65	IP65	IP65
Enclosure material		PBT, black	CuZn39Pb3	PBT, red	PBT, red	PBT, red
Connection		5 x 0.5 mm <sup>2</sup>	M12 x 1	3 x 0.5 mm <sup>2</sup>	M12 x 1	2 x 0.5 mm <sup>2</sup>

Please refer to Accessories for cable couplers, mounting brackets and sensor tester.



<b>E50</b>	<b>E68</b>		
Flush 8 mm Cable 2 m	Flush 10 mm Cable 2 m		

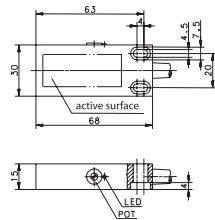
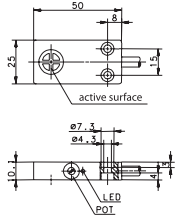

<b>6507990001</b> KCB-E50PS/008-KLP2	<b>6507956001</b> KCB-E68PS/010-KLP2				
<b>6507390001</b> KCB-E50NS/008-KLP2					

10–36 VDC	10–36 VDC		
≤ 200 mA	≤ 200 mA		
25 Hz	25 Hz		
Cyclic	Cyclic		
LED/-	LED/-		
Poti	Poti		

-25°C/+70°C	-25°C/+70°C		
IP65	IP65		
PBT, black	PBT, black		
3 x 0.34 mm <sup>2</sup>	3 x 0.5 mm <sup>2</sup>		

You will find detailed data sheets to the products under [www.bernstein.eu](http://www.bernstein.eu)



# Magnetic Switches

## General Information on BERNSTEIN Magnetic Switches

### Electromechanical and electronic variants

BERNSTEIN has extended its range of electromechanical magnetic switches with electronic versions which operate according to the Hall and magnetoresistive principle.

Electromechanical and electronic magnetic switches have special properties which ensure optimum use in their respective environments.

The electronic versions are characterised by their enhanced mechanical properties (extremely high resistance to vibration, shock or impact) and are not prone to wear in operation.

Thanks to the use of only one single “active” component (reed contact), “traditional” electromechanical magnetic switches are extremely reliable in operation. The universal current capability and low procurement costs allow these switches to be used in a wide range of applications.

The matrix below highlights the main features of each functional principle and helps you to decide on which magnetic switch to use for your application.



### Technical features and applications

More detailed information on the technical features and applications relating to the different functional principles are provided in the following sections.

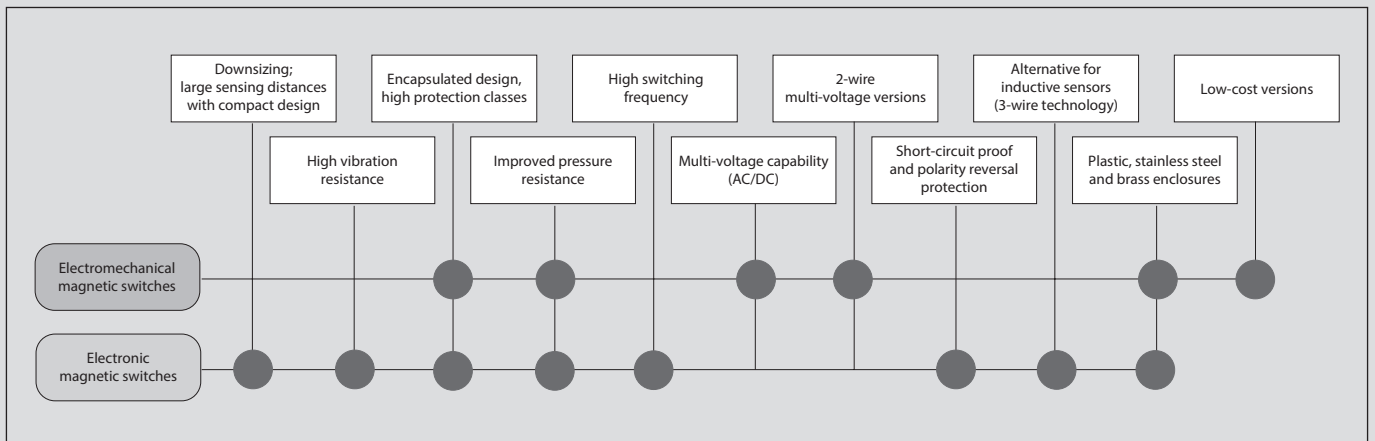



# Electromechanical Magnetic Switches

## Special features of electromechanical magnetic switches

- Reliable under extreme ambient conditions such as dirt, humidity, gas, dust, etc.
- Protection class up to IP67
- Stable switching point, reproducible switching point accuracy of approx. 0.1 mm
- Can be operated from several directions
- Can be mounted in any position
- High operational reliability ensured by the use of only one single component
- Easy to install
- Long electrical service life (depending on the load to be switched) more than 10<sup>8</sup> switching cycles if contacts are suitably protected
- Special versions available for extreme temperatures from -40 °C to +150 °C
- Can be connected to direct and alternating voltage sources

## Design, function and operating principle of an electromechanical magnetic switch

The basic elements of this type of switch are the components which change their electrical characteristics in response to the approach of an actuating magnet. The contact paddles assume opposing polarity (north and south pole) under the influence of a magnetic field.

The approach can be made by either permanent magnets or electromagnets; the sensitivity of the switch and the field strength of the magnet determine the distance between the switch and magnet. Opening and closing of the contact studs is determined by the magnet correspondingly approaching or moving away from the switch. Normally-closed, normally-open and changeover contacts as well as bistable versions are included in our range of products.

The magnetically influenced parts and their auxiliary components (resistor, diode, triac, output stage, etc.) are cast in high quality insulating material or casting compound to increase the vibration / impact strength and guarantee a protection class up to IP67. Metal versions (stainless steel, aluminium and brass) as well as standard plastic versions are available for use under extreme ambient conditions such as wider temperature ranges.

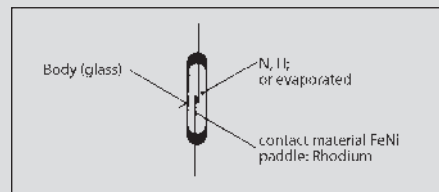

Design of a reed contact

## Biasing (bistable)

Bias magnets energise or hold the contact closed. The contact of the bistable normally-open or normally-closed contact is held closed until a stronger magnet with opposite polarity neutralises the biasing.

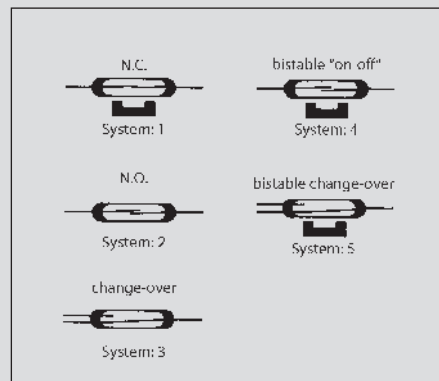

Types of reed contact switches

## Actuation and switching characteristics

The switching characteristics are principally determined by the approach and polarity of the magnet. The following drawings show typical characteristics. Materials and external dimensions are specified in the product overview. Magnetic switches with reed contact output are identified by an "A" in the second position of the type code (MA...).

## Switching frequency

Up to 200 Hz, depending on the size of load to be switched (considerably faster than relays, contactors etc.).

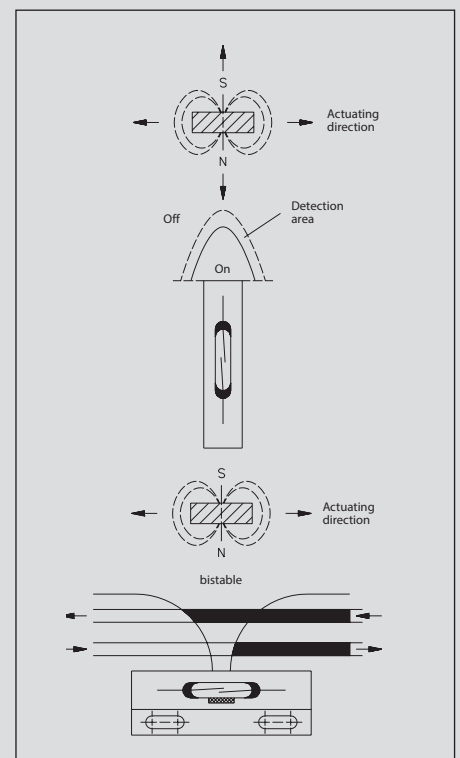
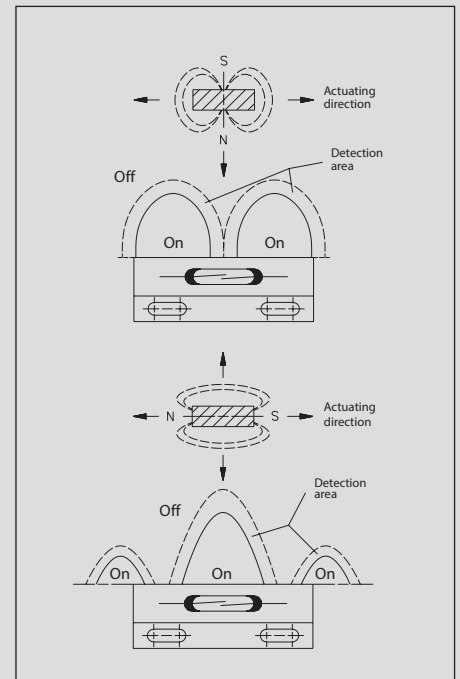

# Magnetic Switches

## Switching distances

Refer to the tables in this catalogue to identify which switching magnets may be used as well as the minimum achievable switching distance.

## Temperature ranges

The standard version may be used in a temperature range from  $-5\text{ }^{\circ}\text{C}$  to  $+70\text{ }^{\circ}\text{C}$ . Special types are also available offering an extended operating temperature range from  $-40\text{ }^{\circ}\text{C}$  to  $+150\text{ }^{\circ}\text{C}$ .

## Electrical service life

To maintain a long service life of the electrical contacts, it is important to ensure the maximum supply voltage and maximum switching current are not exceeded. Refer to the diagrams on Page 67 for the load values.

## Guidelines for reed contact protection

The values for current, voltage and power specified in the catalogue apply only to purely resistive loads. Very often, however, these loads are exposed to inductive or capacitive components. In these cases it is advisable to protect the reed contacts against voltage and current peaks. Whilst it is not possible to recommend a safe contact protection concept that applies to all load ranges (each individual case will require its own evaluation), we would like to present general guidelines on how reed contacts may be connected to different loads in order to avoid premature failure.

## 1. Inductive loads

In DC applications, contact protection is relatively easy to realise with the aid of a free-wheeling diode connected in parallel to the load. The diode polarity must be selected so that it blocks when normal operating voltage is applied but will short-circuit the voltage induced after the switch is opened (voltage peaks can significantly exceed the operating voltage).

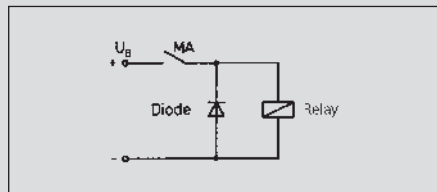

Suppression of voltage peaks with a free-wheeling diode

1) Voltage peaks induced by switching off inductive loads are suppressed by connecting a voltage-dependent resistor (VDR) in parallel to the reed contact.

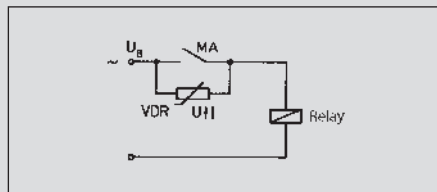

Suppression of voltage peaks with a VDR

2) In AC voltage applications effective protection is achieved with a combination of a resistor and a capacitor (RC element).

Generally, the RC element is connected parallel to the contact and therefore in series to the load (vice versa is also possible).

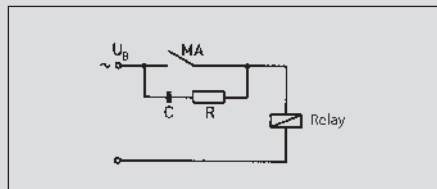

Suppression of voltage peaks with RC element

## 2. Capacitive loads

In contrast to inductive loads, an increase of making currents can occur in connection with capacitive loads and lamp loads that could damage and even weld contacts closed. When capacitors are switched (e.g. cable capacitance) a very high peak current occurs with its intensity depending on the capacitance and length of the cable leading to the switch.

A resistor connected in series to the contact will reduce this current. The size of the resistor is determined by the characteristics of the corresponding electric circuit.

It should, however, be as large as possible to reduce the current to a permissible value, thus ensuring reliable contact protection.

## Contact protection with resistors for limiting current:

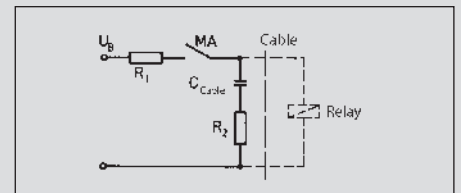

Capacitive load

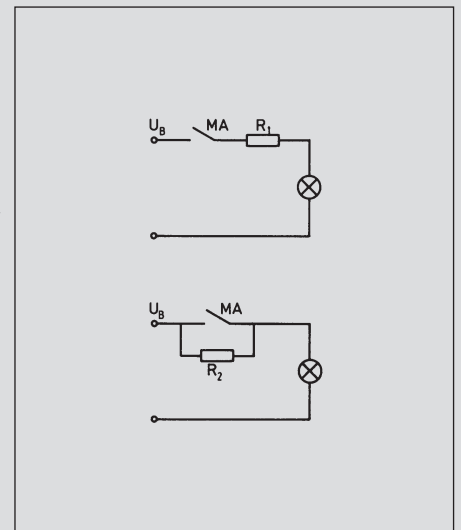

Lamp load

Performance diagrams for electromechanical magnetic switches

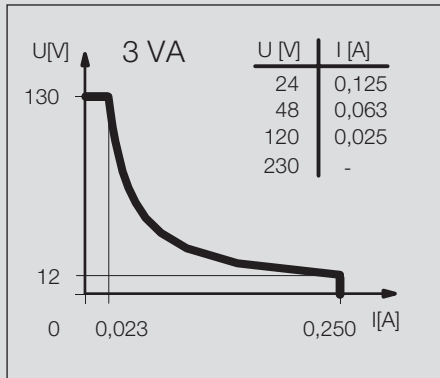

(1)

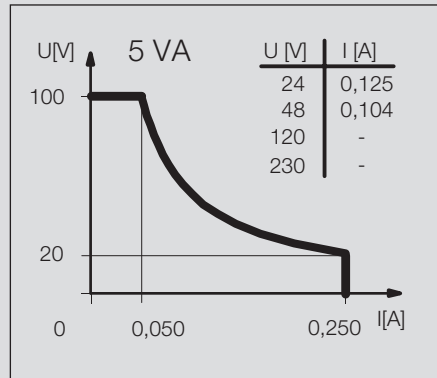

(2)

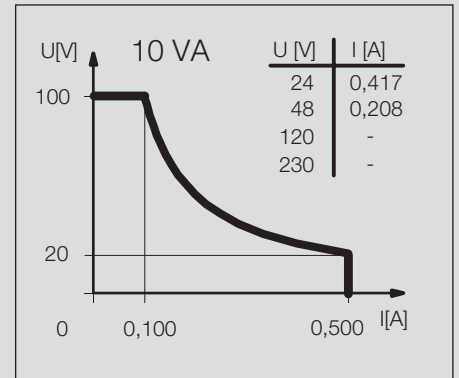

(3)

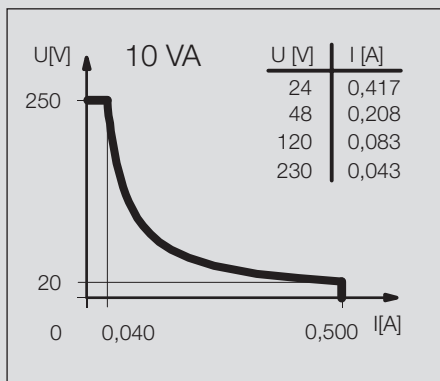

(4)

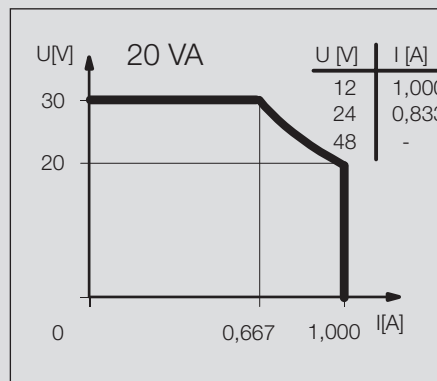

(5)

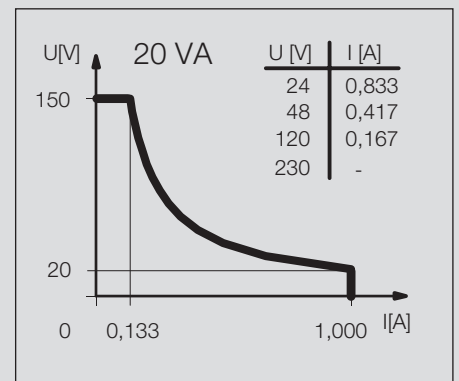

(6)

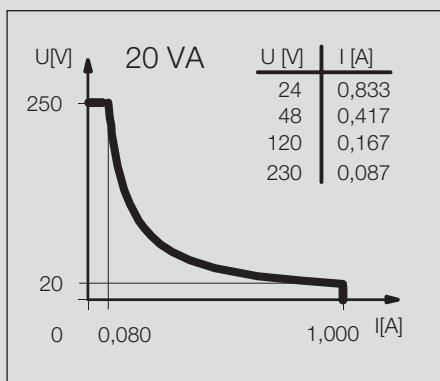

(7)

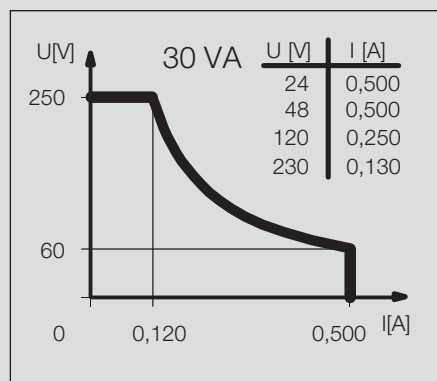

(8)

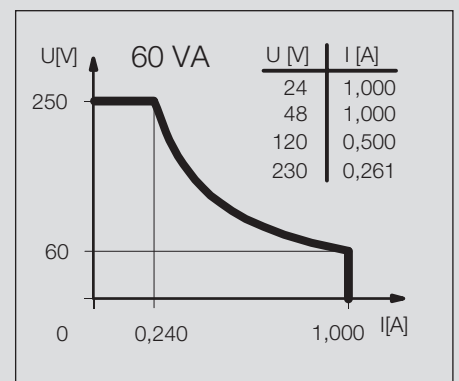

(9)

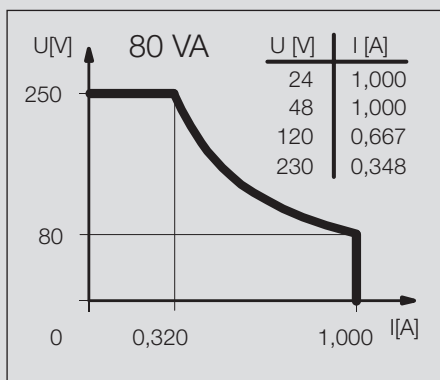

(10)

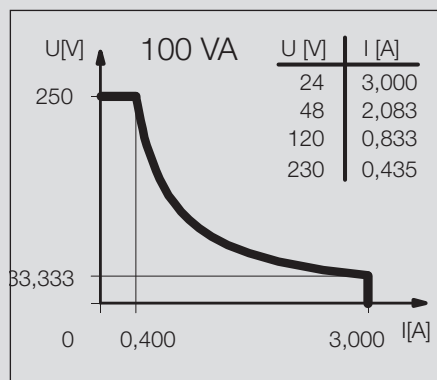

(11)

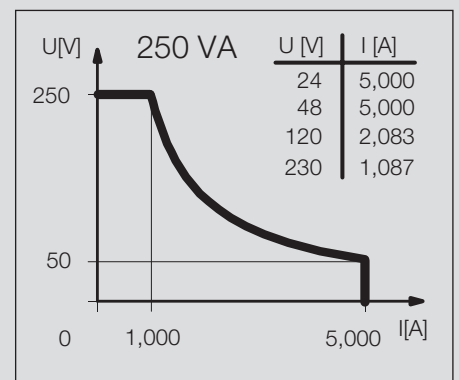

(12)

# Magnetic Switches (Type Ø 6 mm, Ø 6.5 mm, Ø 12 mm, Ø 13 mm)

Type	Ø 6 mm		Ø 6.5 mm		Ø 12 mm	
Nominal switching distance (San)	19 mm	19 mm	18 mm		6 mm	7 mm
Type of connection	Cable 1 m	Cable 1 m	Cable 2 m		Cable 1 m	Cable 1 m
Reference magnet (Page)	T-62 N/S	T-62 N/S	T-62 N/S		T-62 N/S	T-62 N/S
Special feature						

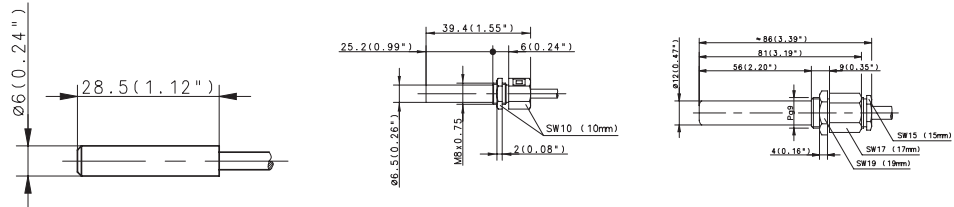

Switching function	NO contact	<b>6311230571</b>	<b>6310246500</b>		<b>6314206246</b>
	Type	MAK-3012-B-1	MAK-4612-A-2		MAA-0612-F-1
NC contact	Type				
	Changeover contact	<b>6310330572</b>		<b>6317306315</b>	
Type		MAK-3013-X-1		MAA-0613-M-1	
	Bistable				
Type					

Technical data	Ø 6 mm		Ø 6.5 mm		Ø 12 mm	
Max. switching voltage	100 V	250 V	250 V		250 V	250 V
Switching current (max)	0.25 A	0.5 A	0.5 A		1 A	3 A
Performance class (diagram No.)	5 VA	10 VA	20 VA		80 VA	100 VA
Shock resistance		50 g (11 ms)				

Mechanical data	Ø 6 mm		Ø 6.5 mm		Ø 12 mm	
Ambient temperature (min/max)	-5°C/+70°C	-5°C/+70°C	-5°C/+70°C		-5°C/+70°C	-5°C/+70°C
Protection class in accordance with IEC 529, EN 60529	IP67	IP67	IP67		IP67	IP67
Enclosure material	PA	PA	PA		Aluminium	Al/CuZn39Pb3
Connection	3 x 0.14 mm <sup>2</sup>	2 x 0.14 mm	2 x 0.14 mm <sup>2</sup>		4 x 0.75 mm <sup>2</sup>	3 x 0.75 mm <sup>2</sup>

Please refer to Accessories for magnets, mounting brackets, cable couplers and sensor tester.

Type	Ø 12 mm		Ø 12 mm		Ø 12 mm	
Nominal switching distance (San)	7 mm	7 mm	7 mm	7 mm	8 mm	12 mm
Type of connection	Cable 1 m	Cable 3 m	Cable 8 m	Cable 2 m	Cable 1 m	Cable 1 m
Reference magnet (Page)	T-62 N/S	T-62 N/S	T-62 N/S	T-62 N/S	T-62 N/S	T-62 N/S
Special feature			Temperature			

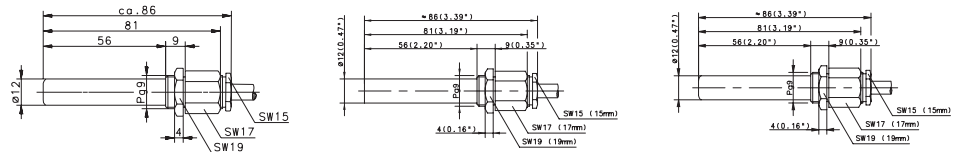

Switching function	NO contact	<b>6312206321</b>	<b>6314216476</b>	<b>6314216585</b>	<b>6314226423</b>	
	Type	MAA-0612-D-1	MAN-1612-F-3	MAN-1612-FT-8	MAK-2612-F-1	
NC contact	Type					
	Changeover contact					<b>6315306314</b>
Type						MAA-0613-K-1
	Bistable					<b>6316316259</b>
						MAN-1613-L-1

Technical data	Ø 12 mm		Ø 12 mm		Ø 12 mm	
Max. switching voltage	250 V	250 V	250 V	250 V	250 V	250 V
Switching current (max)	0.5 A	3 A	3 A	3 A	0.5 A	1 A
Performance class (diagram No.)	30 VA	100 VA	100 VA	100 VA	30 VA	60 VA
Shock resistance		50 g (11 ms)				

Mechanical data	Ø 12 mm		Ø 12 mm		Ø 12 mm	
Ambient temperature (min/max)	-5°C/+70°C	-5°C/+70°C	-40°C/+150°C	-5°C/+70°C	-5°C/+70°C	-5°C/+70°C
Protection class in accordance with IEC 529, EN 60529	IP67	IP67	IP67	IP67	IP67	IP67
Enclosure material	Aluminium	Stainless steel 1.4305	Stainless steel 1.4305	PA, red	Al/CuZn39Pb3	Stainless steel 1.4305
Connection	3 x 0.75 mm <sup>2</sup>	3 x 0.75 mm <sup>2</sup>	3 x 0.75 mm <sup>2</sup>	2 x 0.5 mm <sup>2</sup>	4 x 0.75 mm <sup>2</sup>	4 x 0.75 mm <sup>2</sup>

Please refer to Accessories for magnets, mounting brackets, cable couplers and sensor tester.

Ø 12 mm		Ø 12 mm		Ø 12 mm		Ø 13 mm	
12 mm	12 mm	16 mm	18 mm	19 mm	19 mm	9 mm	20 mm
Cable 1 m	Cable 1 m	Cable 4 m	Cable 1m	Cable 1 m	Cable 1 m	Cable 1 m	Cable 1 m
T-62 N/S	T-62 N/S	T-62 N/S	T-62 N/S	T-69 N/S	T-69 N/S	T-62 N/S	T-62 N/S
		Temperature			Temperature		

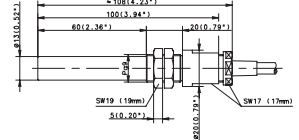
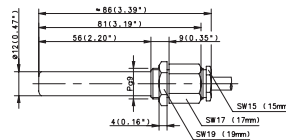
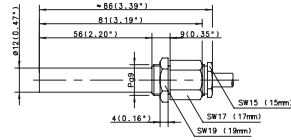
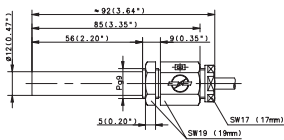

<b>6316326426</b> MAK-2613-L-1	<b>6315326425</b> MAK-2613-K-1	<b>6410206399</b> MAA-0612-NT-4	<b>6310406554</b> MAA-0614-P-1	<b>6316306248</b> MAA-0613-L-1	<b>6316306004</b> MAA-0613-LT-1	<b>6310136616</b> MAK-3611-P-1	<b>6310536617</b> MAK-3615-L-1
-----------------------------------	-----------------------------------	------------------------------------	-----------------------------------	-----------------------------------	------------------------------------	-----------------------------------	-----------------------------------

250 V	250 V	250 V	250 V	250 V	250 V	250 V	250 V
1 A	0.5 A	1.5 A	5 A	1 A	1 A	5 A	1 A
60 VA	30 VA	50 VA	250 VA	60 VA	60 VA	250 VA	60 VA

-5°C/+70°C	-5°C/+70°C	-40°C/+150°C	-5°C/+70°C	-5°C/+70°C	-40°C/+150°C	-5°C/+70°C	-5°C/+70°C
IP67	IP67	IP67	IP67	IP67	IP67	IP67	IP67
PA, red	PA, red	Al/CuZn39Pb3	Al/CuZn39Pb3	Al/CuZn39Pb3	Al/CuZn39Pb3	PA, black	PA, black
3 x 0.5 mm <sup>2</sup>	3 x 0.5 mm <sup>2</sup>	3 x 0.75 mm <sup>2</sup>	3 x 0.5 mm <sup>2</sup>	4 x 0.75 mm <sup>2</sup>	4 x 0.75 mm <sup>2</sup>	2 x 0.75 mm <sup>2</sup>	3 x 0.75 mm <sup>2</sup>

You will find detailed data sheets to the products under [www.bernstein.eu](http://www.bernstein.eu)





M12		PG9		PG9		28.6x18x6.4mm	
18 mm	22 mm	17 mm	20 mm	20 mm	8 mm	8 mm	
Cable 2 m	Cable 2 m	Cable 2 m	Cable 2 m	Cable 2 m	Cable 1 m	Cable 1.5 m	
T-62 N/S	T-62 N/S	T-62 N/S	T-62 N/S	D	TK-11-11	TK-11-11	

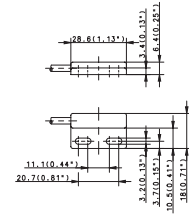
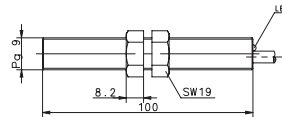
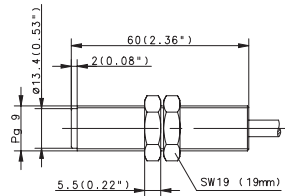
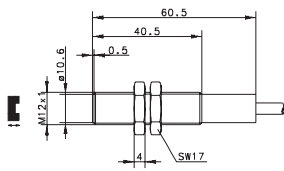

<b>6310118626</b> MAM-1811-2	<b>6410433350</b> MAK-3314-P-2	<b>6316343544</b> MAM-4313-L-2	<b>6310431569</b> MAM-3114-2-LED	<b>6310311615</b> MAK-1113-1	<b>6410311368</b> MAK-1113-1,5
---------------------------------	-----------------------------------	-----------------------------------	-------------------------------------	---------------------------------	-----------------------------------

175 V	250 V	250 V	250 V	130 V	130 V
0.25 A	1.5 A	1 A	1 A	0.25 A	0.25 A
5 VA	250 VA	60 VA	120 VA	3 VA	3 VA
50 g (11 ms)					

-5°C/+70°C	-25°C/+70°C	-5°C/+80°C	-5°C/+80°C	-5°C/+70°C	-20°C/+70°C
IP67	IP67	IP65	IP65	IP67	IP67
CuZn39Pb3	PA, red	CuZn39Pb3	CuZn39Pb3	PA, black	PA
2 x 0.34 mm <sup>2</sup>	2 x 0.5 mm <sup>2</sup>	3 x 0.5 mm <sup>2</sup>	2 x 0.5 mm <sup>2</sup>	3 x 0.14 mm <sup>2</sup>	3 x 0.14 mm <sup>2</sup>

You will find detailed data sheets to the products under [www.bernstein.eu](http://www.bernstein.eu)



# Magnetic Switches (Type 28.6 x 18, 45 x 13, 45 x 25.5, 68 x 30, 80 x 20)

Type	28.6x18x6.4mm		45x13x9mm		45x25.5x9mm	
Nominal switching distance (San)	10 mm	25 mm	10 mm		5 mm	10 mm
Type of connection	Cable 1 m	Cable 5 m	Cable 2 m		Cable 1 m	Cable 1 m
Reference magnet (Page)	TK-11-11	T-67 N/S	TK-11-01		TK-45	TK-45
Special feature						

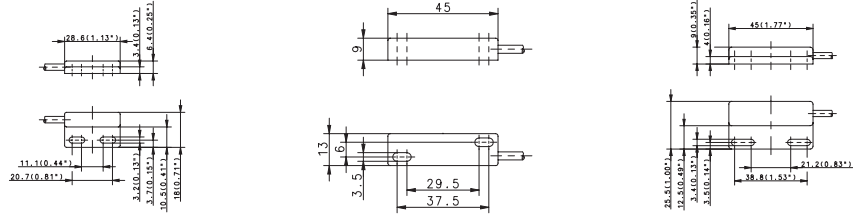

Switching function	NO contact	<b>6311211541</b>	<b>6311201095</b>	<b>6311245539</b>
	Type	MAK-1112-B-1	MAK-0112-B-2	MAK-4512-B-1
NC contact	Type			
	Changeover contact			
Type		<b>6311411603</b>		
	Bistable	MAK-1114-B-5		
Type				<b>6316345540</b>
				MAK-4513-L-1

Technical data	28.6x18x6.4mm		45x13x9mm		45x25.5x9mm	
Max. switching voltage	250 V	250 V	250 V		250 V	250 V
Switching current (max)	0.5 A	0.5 A	0.5 A		1 A	0.5 A
Performance class (diagram No.)	10 VA	10 VA	10 VA		60 VA	10 VA
Shock resistance						50 g (11 ms)

Mechanical data	28.6x18x6.4mm		45x13x9mm		45x25.5x9mm	
Ambient temperature (min/max)	-5°C/+70°C		-5°C/+70°C		-5°C/+70°C	
Protection class in accordance with IEC 529, EN 60529	IP67		IP67		IP67	
Enclosure material	PA, black		PA, black		PA	
Connection	2 x 0.14 mm		2 x 0.14 mm		2 x 0.34 mm <sup>2</sup>	

Please refer to Accessories for magnets, mounting brackets, cable couplers and sensor tester.

Type	68x30x15mm		80x20x15mm		80x20x15mm	
Nominal switching distance (San)	8 mm		18 mm	18 mm	20 mm	10 mm
Type of connection	Cable 1 m		Cable 1 m	Cable 1 m	Cable 3 m	Cable 3 m
Reference magnet (Page)	T-62 N/S		TK-21-02	TK-21-02	T-62 N/S	T-67
Special feature					Temperature	

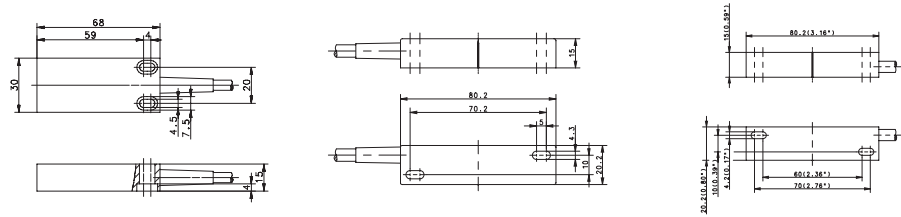

Switching function	NO contact	<b>6316313004</b>	<b>6315302309</b>	<b>6315312196</b>	<b>6314402566</b>	<b>6419402397</b>
	Type	MAK-1313-L-1	MAK-0213-K-1	MAK-1213-K-1	MAA-0214-FT-3	MAK-0214-P-3
NC contact	Type					
	Changeover contact					
Type						
	Bistable					

Technical data	68x30x15mm		80x20x15mm		80x20x15mm	
Max. switching voltage	250 V		250 V	250 V	250 V	250 V
Switching current (max)	1 A		0.5 A	0.5 A	3 A	5 A
Performance class (diagram No.)	60 VA		30 VA	30 VA	100 VA	250 VA
Shock resistance						10 g (11 ms)

Mechanical data	68x30x15mm		80x20x15mm		80x20x15mm	
Ambient temperature (min/max)	-5°C/+70°C		-5°C/+70°C	-5°C/+70°C	-40°C/+150°C	-25°C/+70°C
Protection class in accordance with IEC 529, EN 60529	IP67		IP67	IP67	IP67	IP67
Enclosure material	PC, red		PA, black	PA, red	GDAISI12, red	PA, black
Connection	3 x 0.5 mm <sup>2</sup>		3 x 0.75 mm <sup>2</sup>	3 x 0.75 mm <sup>2</sup>	3 x 0.75 mm <sup>2</sup>	2 x 0.5 mm <sup>2</sup>

Please refer to Accessories for magnets, mounting brackets, cable couplers and sensor tester.



80x20x15 mm		80x20x15 mm		80x20x15 mm	
21 mm	21 mm	21 mm	24 mm	24 mm	25 mm
Cable 1 m	Cable 1 m	Cable 1 m	Cable 1 m	Cable 1 m	Cable 1 m
TK-21-02	TK-21-02	TK-21-12	TA-21-02	TK-21-12	T-62 N/S

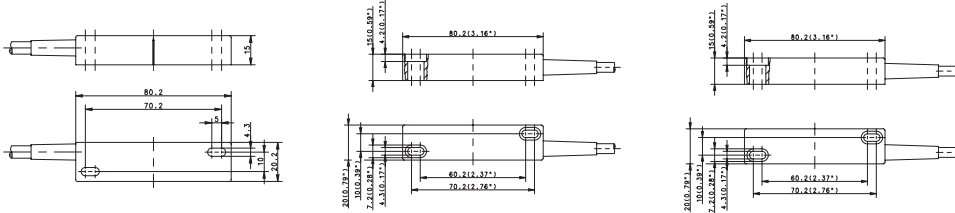

<b>6312202316</b> MAK-0212-L-1	<b>6314202204</b> MAK-0212-F-1	<b>6314212217</b> MAK-1212-F-1	<b>6316302206</b> MAK-0213-L-1	<b>6316312220</b> MAK-1213-L-1	<b>6410412143</b> MAK-1214-L-2
-----------------------------------	-----------------------------------	-----------------------------------	-----------------------------------	-----------------------------------	-----------------------------------

250 V	250 V	250 V	250 V	250 V	250 V
0.5 A	3 A	3 A	1 A	1 A	1 A
30 VA	100 VA	100 VA	60 VA	60 VA	60 VA

-5°C/+70°C	-5°C/+70°C	-5°C/+70°C	-5°C/+70°C	-5°C/+70°C	-5°C/+70°C
IP67	IP67	IP67	IP67	IP67	IP67
PA, black	PA, black	PA, red	PA, black	PA, red	PA, red
2 x 0.75 mm <sup>2</sup>	2 x 0.75 mm <sup>2</sup>	2 x 0.5 mm <sup>2</sup>	3 x 0.5 mm <sup>2</sup>	3 x 0.5 mm <sup>2</sup>	2 x 0.5 mm <sup>2</sup>

You will find detailed data sheets to the products under [www.bernstein.eu](http://www.bernstein.eu)



# Magnetic Switches (Type 80 x 20 mm, 80 x 30 mm, 85 x 24 mm, 88 x 25 mm, 100 x 58 mm)

Type	80x20x15 mm		80x30x15 mm		80x30x15 mm	
Nominal switching distance (San)	25 mm	30 mm	8 mm	19 mm	20 mm	22 mm
Type of connection	Connector M8	Cable 1 m	Cable 1 m	Cable 1 m	Cable 1 m	Cable 1 m
Reference magnet (Page)	Ø 10 x 50 Neod	TA-21-02	TK-44	TK-44	T-62 N/S	TK-44
Special feature		Temperature				

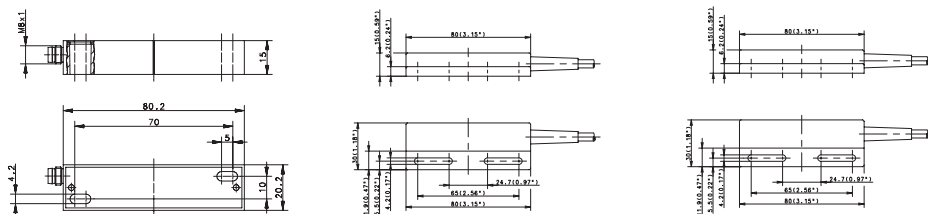

Switching function	NO contact			<b>6314244536</b>	
	Type			MAK-4412-F-1	
NC contact	Type		<b>6314144542</b>		
	Changeover contact		MAK-4411-F-1		
Type	Bistable	<b>6310302636</b>	<b>6316302389</b>		<b>6317344538</b>
	Type	MAA-0213-STK	MAA-0213-LT-1		MAK-4413-M-1
Type				<b>6310444537</b>	
				MAK-4414-P-1	

Technical data	80x20x15 mm		80x30x15 mm		80x30x15 mm	
Max. switching voltage	60 V	250 V	250 V	250 V	250 V	250 V
Switching current (max)	1 A	1 A	3 A	3 A	5 A	1 A
Performance class (diagram No.)	3 VA	60 VA	100 VA	100 VA	250 VA	80 VA
Shock resistance		10 g (11 ms)				

Mechanical data	80x20x15 mm		80x30x15 mm		80x30x15 mm	
Ambient temperature (min/max)	-30°C/+80°C	-40°C/+150°C	-5°C/+70°C	-5°C/+70°C	-5°C/+70°C	-5°C/+70°C
Protection class in accordance with IEC 529, EN 60529	IP65	IP67	IP67	IP67	IP67	IP67
Enclosure material	GDAISi 12, red	GDAISi12, red	PA, black	PA, black	PA, black	PA
Connection	M8 x 1	4 x 0.75 mm <sup>2</sup>	2 x 0.5 mm <sup>2</sup>	2 x 0.5 mm <sup>2</sup>	2 x 0.5 mm <sup>2</sup>	3 x 0.5 mm <sup>2</sup>

Please refer to Accessories for magnets, mounting brackets, cable couplers and sensor tester.

Type	85x24x26 mm		85x24x26 mm		88x25x13 mm	
Nominal switching distance (San)	15 mm	24 mm	24 mm		22 mm	25 mm
Type of connection	Cable 3 m	Cable 1 m	Flat plug		Cable 1 m	Cable 1 m
Reference magnet (Page)	T-67 N/S	T-69 N/S	T-69 N/S		TK-42	TK-42
Special feature			K4.8			

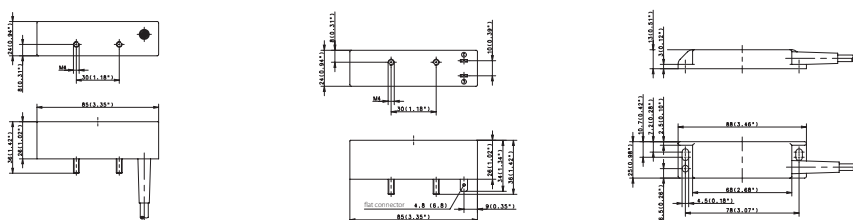

Switching function	NO contact				<b>6314242533</b>
	Type				MAK-4212-F-1
NC contact	Type				
	Changeover contact				
Type	Bistable	<b>6314432609</b>	<b>6310432598</b>	<b>6310432590</b>	<b>6317342535</b>
	Type	MAK-3214-F-3	MAK-3214-P-1	MAK-3214-P-STK4.8	MAK-4213-M-1

Technical data	85x24x26 mm		85x24x26 mm		88x25x13 mm	
Max. switching voltage	250 V	250 V	250 V		250 V	250 V
Switching current (max)	3 A	5 A	5 A		1 A	3 A
Performance class (diagram No.)	100 VA	250 VA	250 VA		80 VA	100 VA
Shock resistance						

Mechanical data	85x24x26 mm		85x24x26 mm		88x25x13 mm	
Ambient temperature (min/max)	-25°C/+70°C	-5°C/+70°C	-20°C/+70°C		-5°C/+70°C	-5°C/+70°C
Protection class in accordance with IEC 529, EN 60529	IP67	IP67	IP67		IP67	IP67
Enclosure material	PBT	PA, black	PBT, black		PA, black	PA, black
Connection	2 x 0.5 mm <sup>2</sup>	2 x 0.75 mm <sup>2</sup>	4.8 mm		3 x 0.5 mm <sup>2</sup>	2 x 0.5 mm <sup>2</sup>

Please refer to Accessories for magnets, mounting brackets, cable couplers and sensor tester.

88x25x13 mm		100x58x29.5		100x58x29.5	
25 mm	25 mm	10 mm	10 mm	15 mm	
Cable 1 m	Cable 3 m	Screw terminal	Screw terminal	Screw terminal	
T-69 N/S	T-69 N/S	TA-31	TA-31	T-62 N/S	

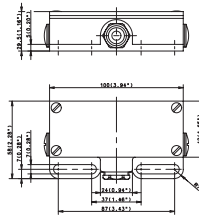
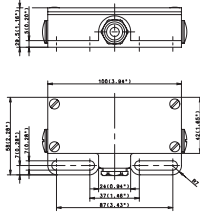
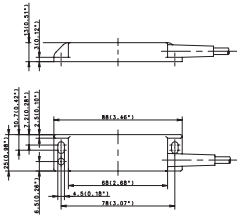

			<b>6314203232</b> MAA-0312-F		
<b>6310442534</b> MAK-4214-P-1	<b>6310442622</b> MAK-4214-P-3	<b>6317303312</b> MAA-0313-M		<b>6319403532</b> MAA-0314-P	

250 V	250 V	250 V	250 V	250 V
5 A	5 A	1 A	3 A	5 A
250 VA	250 VA	80 VA	100 VA	250 VA

-5°C/+70°C	-5°C/+70°C	-5°C/+70°C	-25°C/+70°C	-25°C/+70°C
IP67	IP67	IP67	IP65	IP65
PA, black	PA, black	Aluminium	Aluminium	Aluminium
2 x 0.5 mm <sup>2</sup>	2 x 0.5 mm <sup>2</sup>	max. 1.5 mm <sup>2</sup>	max. 1.5 mm <sup>2</sup>	max. 1.5 mm <sup>2</sup>

You will find detailed data sheets to the products under [www.bernstein.eu](http://www.bernstein.eu)



# Electronic Magnetic Sensors

Thanks to their special properties, electronic magnetic switches with magnetoresistive or Hall elements are ideal for use in many different applications. They are used to detect position, angle and / or speed and are immune to shock, impact, vibration and wear. High switching frequencies, long switching distances, a broad temperature range and excellent reproducibility are other advantageous features of this technology which in many cases make them the technically superior alternative to electromechanical reed contacts.



The fact that many non-magnetic metals allow magnetic fields to pass unhindered also extends the fields of application for magnetic sensors. This makes it possible to encapsulate sensors in a sturdy pressure-proof metal enclosure. Sensors can, however, also be mounted in tubing or concealed behind non-magnetic metal surfaces.

### Advantages of electronic magnetic sensors over electromechanical reed contacts

- Reliable and immune to vibration
- Bounce-free switching
- Unlimited service life
- High repeat accuracy
- Short response times
- High sensitivity
- Thermal stability

Select the sensor and the technical principle that best meet your requirements from the comprehensive BERNSTEIN range of magnetic sensors: Hall sensors with minimum circuitry, standard Hall sensors with integrated sensor electronics or magnetoresistive sensors. Round, square or metric bodies in plastic, brass, brass / plastic or stainless enclosures.

### Fundamentals of Hall sensor technology

The BERNSTEIN range of magnetic sensors is based on a modular system comprising an encapsulated Hall element with the EMC protective circuitry. These sensors therefore conform to the requirements of EN-60947-5-2 for non-mechanical magnetic proximity switches. Sensors of various designs are available for a wide variety of applications.

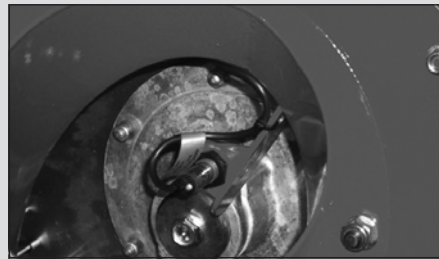

- Output circuitry NPN, NO contact or bistable
- Voltage range 4.5 – 24 V DC
- Polarity reversal protected
- Switching frequencies up to 20 kHz
- Size ranging from 6 mm diameter to 50 x 25 x 10 mm
- Unipolar version

### Standard range of Hall sensors

In contrast to the more basic BERNSTEIN Hall sensors, the functionality and modularity have been enhanced in these Hall sensors by integrating comprehensive sensor electronics. In this segment BERNSTEIN also offers a complete modular system that can be adapted to suit your specific needs.

- Output circuitry PNP, NC or NO contact or bistable
- Voltage range 10 – 39 V DC
- Output current 400 mA, short-circuit proof
- Polarity reversal protected
- Switching frequencies up to 10 kHz
- Size ranging from M10 diameter to 50 x 25 x 10 mm
- Unipolar version

### Single-channel speed sensors with high frequency range

BERNSTEIN offers a high performance series of gearwheel sensors designed as electronic magnetic sensors with Hall elements that detect the rotation of near-engine ferromagnetic gearwheels with sensing distances of up to 2 mm. A specific feature of these single-channel speed sensors is their high switching frequency. Based on the BERNSTEIN modular range of magnetic sensors, switching frequencies of up to 20 kHz can be realised. Switching frequencies up to 10 kHz can be achieved in the standard range. The sensors are available in M12 and M18 versions. The characteristic versatility of Hall sensors is fully utilised in these applications:

Outstanding immunity to shock, impact, vibration, non-wearing and silent, high switching frequencies, broad temperature range, exceptional repeat accuracy.

### Technical data

- Output circuitry PNP or NPN
- Voltage range 10 – 36 V DC
- Switching frequencies up to 20 kHz
- Sensing distance 0 – 2 mm on ferromagnetic material

### Standard range of magnetoresistive sensors

Magnetoresistive sensors are more sensitive than Hall-effect sensors by a factor of 10. Not only can they be very small but they can also detect especially low field strengths.

In addition to their high measuring accuracy even at high ambient temperatures, these sensors are also characterised by a high degree of reliability and by the fact that they occupy little space. Since they are designed to be independent of polarity, the countermagnet does not need to be mounted with pole orientation. With corresponding encapsulation, BERNSTEIN magnetoresistive sensors have proven effective even in demanding environments such as lift construction or agricultural technology.

- Output circuitry PNP, NC or NO contact
- High sensitivity (up to sensing distance of 60 mm)
- Voltage range 10 – 39 V DC/10 – 30 V DC
- Output current 400 mA/200 mA, short-circuit proof
- Polarity reversal protected
- Polarity independent
- Size 6 mm diameter to M18

### Microsensors

Ever more complex and above all more compact measuring and control configurations require components that occupy even less space. In line with this trend, BERNSTEIN has expanded its comprehensive range of sensors for determining position, angle and / or speed in industrial applications in two branches of development: Compared to the previous smallest model (RD = 6 mm), the diameter in this series of magnetoresistive sensors has been further reduced by 30 % yet the smallest model RD = 4 mm or 5 x 5 mm still achieves the parameters of the larger sensors. As part of the second development stage, the basic and standard range of electronic magnetic sensors has been expanded to include the latch functionality (bistable switching characteristic) which utilises the magnetic field only for the corresponding switching operation. As a result, this functionality has been added to a wide range of enclosure variants in the current modular range.

### Sensing distances of electronic magnetic sensors

Since the sensing distances of magnetic sensors are influenced by the combination of sensor and magnet, it is appropriate to consider them as a complete system. The overview below shows the expected sensing distances (Sn) when using different magnets from the BERNSTEIN range.

Magnet	Size	Article number	Sn of Hall sensors	Sn of magneto-resistive sensors
T 75	Ø 5 mm	<b>6301175057</b>	5 mm	10 mm
T 06	Ø 6 mm	<b>6301106065</b>	5 mm	15 mm
T 61	Ø 20 mm	<b>6301261035</b>	10 mm	35 mm
T 62	Ø 23 mm	<b>6301262039</b>	17 mm	45 mm
T 67	Ø 20 mm	<b>6301167054</b>	15 mm	40 mm
T 69	Ø 31 mm	<b>6301269031</b>	20 mm	60 mm

## Electronic Magnetic Sensors (Type D04, D06, M05, M08, M10, M12)

Type	D04	D06		M05
Operating mode	MR	Hall	MR	MR
Magnetic sensitivity (mT)	3 mT	10 mT	2 mT	3 mT
Sensing distance (S <sub>n</sub> )	30 mm	17 mm	45 mm	30 mm
Reference magnet (Page)	T-62 N/S	T-62 N/S	T-62 N/S	T-62 N/S
Type of connection	Cable 2 m	Cable 2 m	Cable 2 m	Cable 2 m
Special feature				

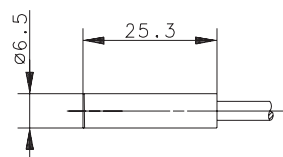
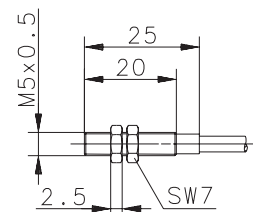
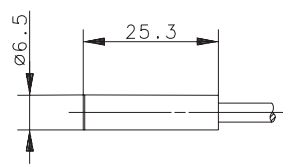
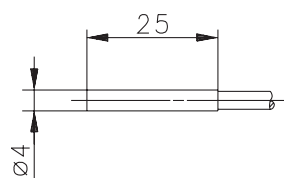

PNP	NO contact Type NC contact Type Bistable Type	6373299132	MEN-D04PS/M03-K2	6373270105	MEN-D06PS/M02-K2	6373299133	MEM-M05PS/M03-K2
NPN	NO contact Type NC contact Bistable Type			6362670001 MEN-D06NS/H10-K2  6363870032 MEN-D06NB/H11-K2			
Analogue	Current output Voltage output						

### Technical data

Rated operating voltage	U <sub>B</sub>	4.5–30 VDC	4.5–24 VDC	10–30 VDC	4.5–30 VDC
Rated operating current	I <sub>e</sub>	200 mA	25 mA	200 mA	200 mA
Max. switching voltage	F	10 kHz	20 kHz	1500 Hz	10 kHz
Function/operating voltage indicator		–/–	–/–	–/–	–/–
Sensitivity adjustable					
Short circuit-protection		Current limiter	Current limiter	Cyclic	Current limiter
Teachable					

### Mechanical data

Ambient temperature (min/max)		–20°C/+70°C	–25°C/+70°C	–25°C/+70°C	–20°C/+70°C
Protection class in accordance with IEC 529, EN 60529		IP67	IP67	IP67	IP67
Enclosure material		Stainless steel 1.4401	Stainless steel 1.4401	Stainless steel 1.4401	CuZn39Pb3
Connection		3 x 0.14 mm <sup>2</sup>	3 x 0.14 mm <sup>2</sup>	3 x 0.14 mm <sup>2</sup>	3 x 0.14 mm <sup>2</sup>

Please refer to Accessories for magnets, mounting brackets, cable couplers and sensor tester.



M08		M10		M10		M12	
Hall	MR	Hall	Hall	MR		Hall	Hall
10 mT	2 mT	10 mT	10 mT	1 mT		10 mT	10 mT
17 mm	45 mm	17 mm	17 mm	45 mm		17 mm	17 mm
T-62 N/S	T-62 N/S	T-62 N/S	T-62 N/S	T-62 N/S		T-62 N/S	T-62 N/S
Cable 2 m	Cable 2 m	Cable 2 m	Cable 2 m	Cable 2 m		Cable 2 m	Cable 2 m
			All-metal	All-metal			

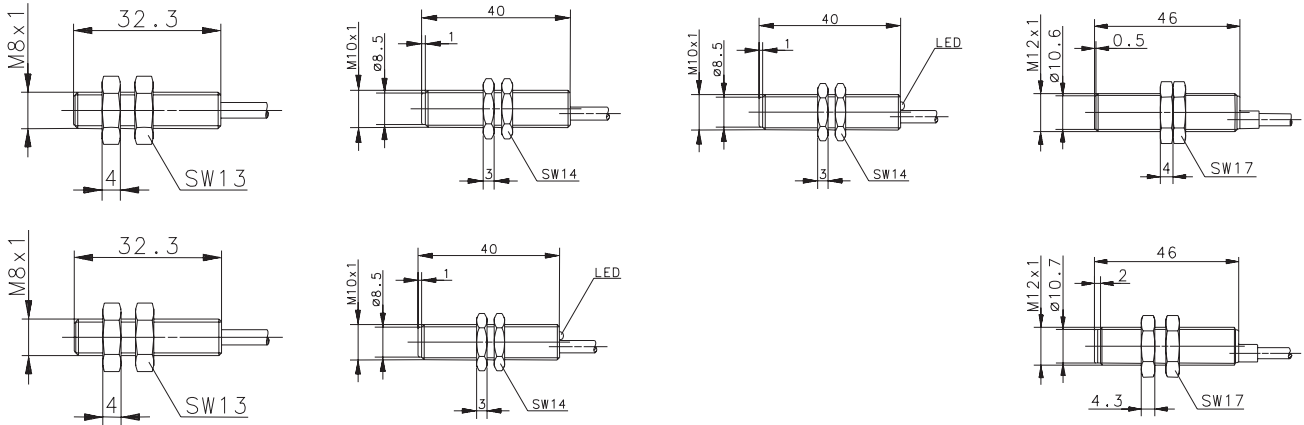

	<b>6373260107</b> MEM-M08PS/M02-K2		<b>6372261085</b> MEM-M10PS/H10-KL2 <b>6372161086</b> MEM-M10PÖ/H10-KL2 <b>6373461124</b> MEM-M10PB/H11-KL2	<b>6373261087</b> MEM-M10PS/M01-KL2 <b>6373161088</b> MEM-M10PÖ/M01-KL2			
<b>6362660002</b> MEM-M08NS/H10-K2		<b>6362661003</b> MEM-M10NS/H10-K2				<b>6362662004</b> MEM-M12NS/H10-K2	<b>6362662005</b> MEK-M12NS/H10-K2
<b>6363860033</b> MEM-M08NB/H11-K2		<b>6363861034</b> MEM-M10NB/H11-K2				<b>6363862035</b> MEM-M12NB/H11-K2	<b>6363862036</b> MEK-M12NB/H11-K2

4.5–24 V	10–30 V	4.5–24 V	10–39 V	10–39 V	4.5–24 V	4.5–24 V
25 mA	200 mA	25 mA	400 mA	400 mA	25 mA	25 mA
20 kHz	1500 Hz	20 kHz	10 kHz	10 kHz	20 kHz	20 kHz
-/-	-/-	-/-	LED/-	LED/-	-/-	-/-
Current limiter	Cyclic	Current limiter	Cyclic	Cyclic	Current limiter	Current limiter

-25°C/+70°C	-25°C/+70°C	-25°C/+70°C	-25°C/+70°C	-25°C/+70°C	-25°C/+70°C	-25°C/+70°C
IP67	IP67	IP67	IP67	IP67	IP67	IP67
CuZn39Pb3	CuZn39Pb3	CuZn39Pb3	CuZn39Pb3	CuZn39Pb3	CuZn39Pb3	PA
3 x 0.14 mm <sup>2</sup>	3 x 0.14 mm <sup>2</sup>	3 x 0.14 mm <sup>2</sup>	3 x 0.14 mm <sup>2</sup>	3 x 0.14 mm <sup>2</sup>	3 x 0.14 mm <sup>2</sup>	3 x 0.14 mm <sup>2</sup>

You will find detailed data sheets to the products under [www.bernstein.eu](http://www.bernstein.eu)

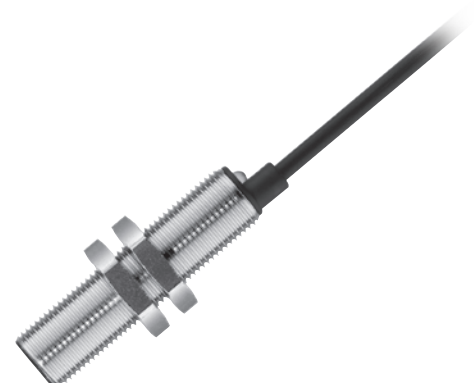

# Electronic Magnetic Sensors (Type M12, M18)

Type	M12		M12		M12	
Operating mode	Hall	Hall	Hall	MR	MR	MR
Magnetic sensitivity (mT)	10 mT	10 mT	10 mT	1 mT	1 mT	1 mT
Sensing distance (S <sub>n</sub> )	17 mm	17 mm	17 mm	45 mm	45 mm	45 mm
Reference magnet (Page)	T-62 N/S	T-62 N/S	T-62 N/S	T-62 N/S	T-62 N/S	T-62 N/S
Type of connection	Cable 2 m	Cable 10 m	Cable 2 m	Cable 2 m	Cable 5 m	Cable 2 m
Special feature						

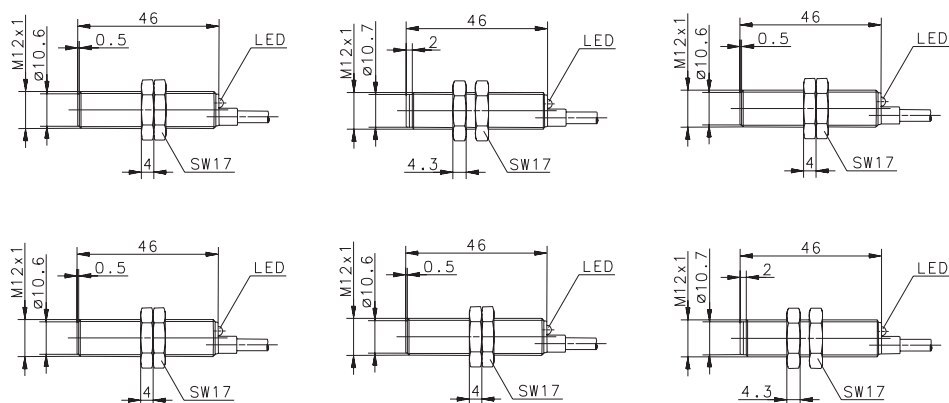

<b>PNP</b>	NO contact Type	<b>6372262090</b> MEM-M12PS/H10-KL2	<b>6472262077</b> MEM-M12PS/H10-KL10	<b>6372262089</b> MEK-M12PS/H10-KL2	<b>6373262094</b> MEM-M12PS/M01-KL2	<b>6373262123</b> MEM-M12PS/M01-KL5	<b>6373262093</b> MEK-M12PS/M01-KL2
	NC contact Type	<b>6372162092</b> MEM-M12PÖ/H10-KL2		<b>6372162091</b> MEK-M12PÖ/H10-KL2	<b>6373162096</b> MEM-M12PÖ/M01-KL2		<b>6373162095</b> MEK-M12PÖ/M01-KL2
<b>NPN</b>	Bistable Type	<b>6373462126</b> MEM-M12PB/H11-KL2		<b>6373462125</b> MEK-M12PB/H11-KL2			
	NC contact Bistable Type						
<b>Analogue</b>	Current output Voltage output						

## Technical data

Rated operating voltage	U <sub>B</sub>	10–39 VDC	10–39 VDC	10–39 VDC	10–39 VDC	10–39 VDC	10–39 VDC
Rated operating current	I <sub>e</sub>	400 mA	400 mA	400 mA	400 mA	400 mA	400 mA
Max. switching voltage	F	10 kHz	10 kHz	10 kHz	10 kHz	1500 Hz	10 kHz
Function/operating voltage indicator		LED/-	LED/-	LED/-	LED/-	LED/-	LED/-
Sensitivity adjustable							
Short circuit-protection		Cyclic	Cyclic	Cyclic	Cyclic	Cyclic	Cyclic
Teachable							

## Mechanical data

Ambient temperature (min/max)		-25°C/+70°C	-25°C/+70°C	-25°C/+70°C	-25°C/+70°C	-25°C/+70°C	-25°C/+70°C
Protection class in accordance with IEC 529, EN 60529		IP67	IP67	IP67	IP67	IP67	IP67
Enclosure material		CuZn39Pb3	CuZn39Pb3	PA	CuZn39Pb3	CuZn39Pb3	PA
Connection		3 x 0.14 mm <sup>2</sup>	3 x 0.14 mm <sup>2</sup>	3 x 0.14 mm <sup>2</sup>	3 x 0.14 mm <sup>2</sup>	3 x 0.14 mm <sup>2</sup>	3 x 0.14 mm <sup>2</sup>

Please refer to Accessories for magnets, mounting brackets, cable couplers and sensor tester.

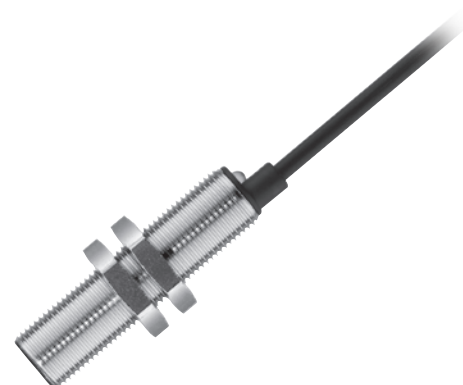



M12		M12		M18		M18	
Hall	Hall	Hall	Hall	Hall	Hall	Hall	Hall
-	-	-	-	10 mT	10 mT	10 mT	10 mT
0-2 mm	0-2 mm	0-2 mm	0-2 mm	17 mm	17 mm	17 mm	17 mm
-	-	-	-	T-62 N/S	T-62 N/S	T-62 N/S	T-62 N/S
Cable 2 m	Cable 2 m	Cable 2 m	Cable 2 m	Cable 2 m	Cable 2 m	Cable 2 m	Cable 2 m
Speed	Speed	Speed	Speed				

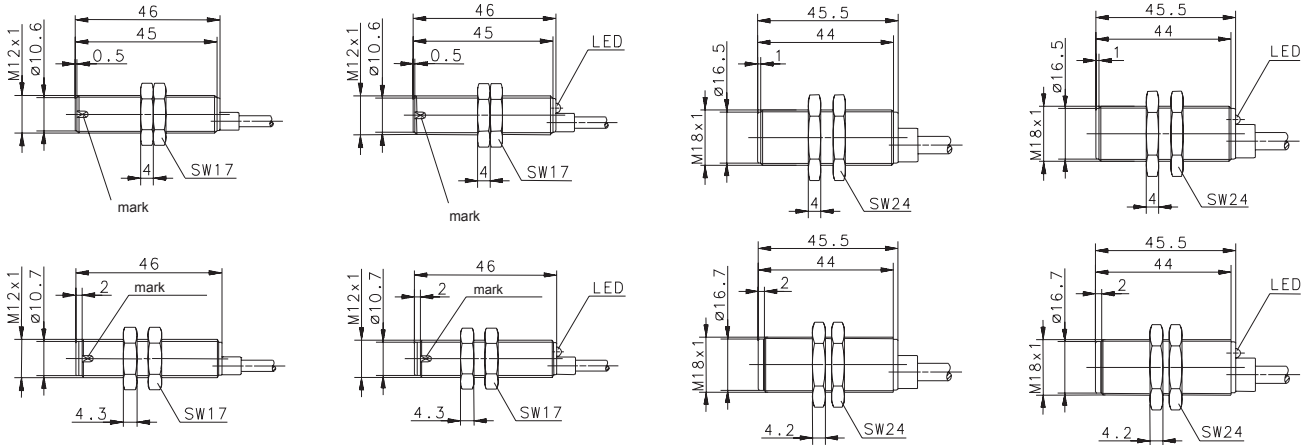

		<b>6379262120</b> MEM-M12PD/H-KL2	<b>6379262119</b> MEK-M12PD/H-KL2			<b>6372263098</b> MEM-M18PS/H10-KL2	<b>6372263097</b> MEK-M18PS/H10-KL2
						<b>6372163100</b> MEM-M18PÖ/H10-KL2	<b>6372163099</b> MEK-M18PÖ/H10-KL2
						<b>6373463128</b> MEM-M18PB/H11-KL2	<b>6373463127</b> MEK-M18PB/H11-KL2
<b>6369662028</b> MEM-M12ND/H-K2	<b>6369662027</b> MEK-M12ND/H-K2			<b>6362663006</b> MEM-M18NS/H10-K2	<b>6362663007</b> MEK-M18NS/H10-K2		
				<b>6363863037</b> MEM-M18NB/H11-K2	<b>6363863038</b> MEK-M18NB/H11-K2		

10-36 V	10-36 V	10-39 V	10-39 V	4.5-24 V	4.5-24 V	10-39 V	10-39 V
< 20 mA	< 20 mA	400 mA	400 mA	25 mA	25 mA	400 mA	400 mA
20 kHz	20 kHz	10 kHz	10 kHz	20 kHz	20 kHz	10 kHz	10 kHz
-/-	-/-	LED/-	LED/-	-/-	-/-	LED/-	LED/-
Cyclic	Cyclic	Cyclic	Cyclic	Current limiter	Current limiter	Cyclic	Cyclic

-25°C/+70°C	-25°C/+70°C	-25°C/+70°C	-25°C/+70°C	-25°C/+70°C	-25°C/+70°C	-25°C/+70°C	-25°C/+70°C
IP67	IP67	IP67	IP67	IP67	IP67	IP67	IP67
CuZn39Pb3	PA, red	CuZn39Pb3	PA, red	CuZn39Pb3	PBT	CuZn39Pb3	PBT
3 x 0.14 mm <sup>2</sup>	3 x 0.14 mm <sup>2</sup>	3 x 0.14 mm <sup>2</sup>	3 x 0.14 mm <sup>2</sup>	3 x 0.14 mm <sup>2</sup>	3 x 0.14 mm <sup>2</sup>	3 x 0.14 mm <sup>2</sup>	3 x 0.14 mm <sup>2</sup>

You will find detailed data sheets to the products under [www.bernstein.eu](http://www.bernstein.eu)

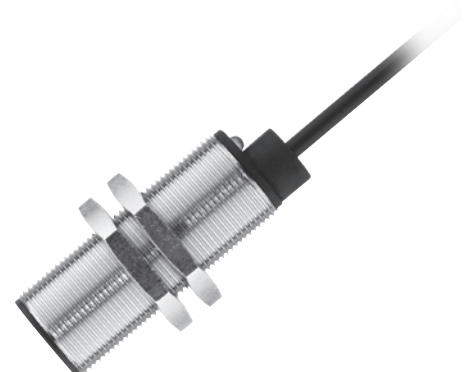

# Electronic Magnetic Sensors (Type M18, Q05, Q08, Q12, E27, E29)

Type	M18		M18		Q05
Operating mode	MR	MR	Hall	Hall	MR
Magnetic sensitivity (mT)	1 mT	1 mT	-	-	3 mT
Sensing distance (S <sub>n</sub> )	45 mm	45 mm	0 – 2 mm	0 – 2 mm	10 mm
Reference magnet (Page)	T-62 N/S	T-62 N/S	-	-	T-62 N/S
Type of connection	Cable 2 m	Cable 2 m	Cable 2 m	Cable 2 m	Cable 2 m
Special feature			Speed	Speed	

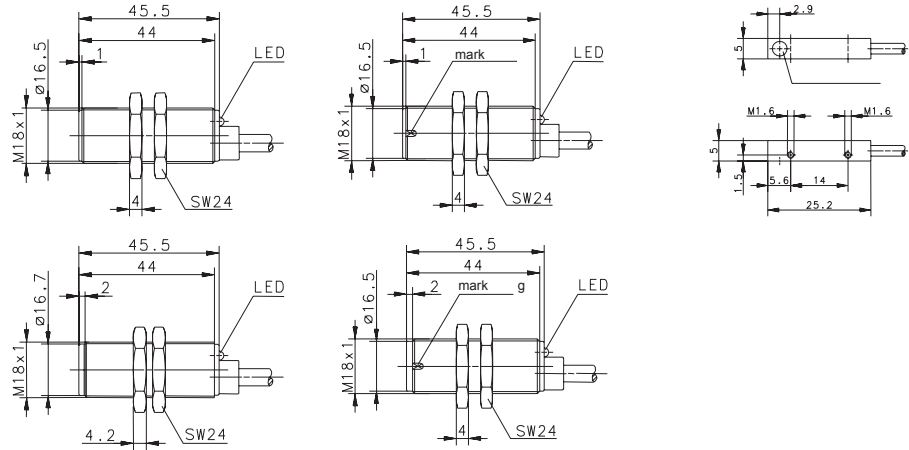

PNP	NPN	Analogue	6373263102	6373263101	6379263122	6379263121	6373299134
NO contact	NO contact	Current output	MEM-M18PS/M01-KL2	MEK-M18PS/M01-KL2	MEM-M18PD/H-KL2	MEK-M18PD/H-KL2	MEM-Q05PS/M03-K2
Type	Type	Voltage output	6373163104	6373163103			
NC contact	NC contact		MEM-M18PÖ/M01-KL2	MEK-M18PÖ/M01-KL2			
Type	Type						
Bistable	Bistable						
Type	Type						

### Technical data

Rated operating voltage	U <sub>B</sub>	10–39 VDC	10–39 VDC	10–39 VDC	10–39 VDC	4.5–30 VDC
Rated operating current	I <sub>e</sub>	400 mA	400 mA	400 mA	400 mA	200 mA
Max. switching voltage	F	10 kHz	10 kHz	10 kHz	10 kHz	10 kHz
Function/operating voltage indicator		LED/-	LED/-	LED/-	LED/-	-/-
Sensitivity adjustable						
Short circuit-protection		Cyclic	Cyclic	Cyclic	Cyclic	Current limiter
Teachable						

### Mechanical data

Ambient temperature (min/max)	-25°C/+70°C	-25°C/+70°C	-25°C/+70°C	-25°C/+70°C	-20°C/+70°C
Protection class in accordance with IEC 529, EN 60529	IP67	IP67	IP67	IP67	IP67
Enclosure material	CuZn39Pb3	PBT	CuZn39Pb3	PBT, black	CuZn39Pb3
Connection	3 x 0.14 mm <sup>2</sup>	3 x 0.14 mm <sup>2</sup>	3 x 0.14 mm <sup>2</sup>	3 x 0.14 mm <sup>2</sup>	3 x 0.05 mm <sup>2</sup>

Please refer to Accessories for magnets, mounting brackets, cable couplers and sensor tester.



Q08		Q12		E27		E29
Hall	MR	Hall	Hall	Hall	Hall	Hall
10 mT	2 mT	10 mT	10 mT	10 mT	2 mT	10 mT
17 mm	45 mm	17 mm	17 mm	17 mm	30 mm	17 mm
T-62 N/S	T-62 N/S	T-62 N/S	T-62 N/S	T-62 N/S	T-62 N/S	T-62 N/S
Cable 2 m	Cable 2 m	Cable 2 m	Cable 2 m	Cable 2 m	Cable 2 m	Cable 2 m

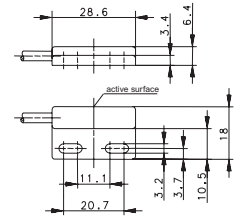
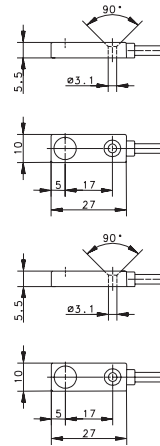
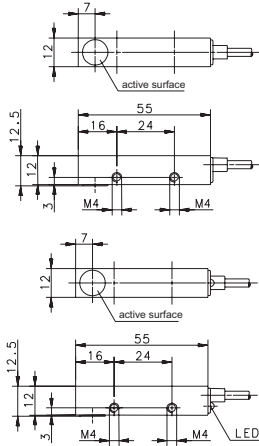
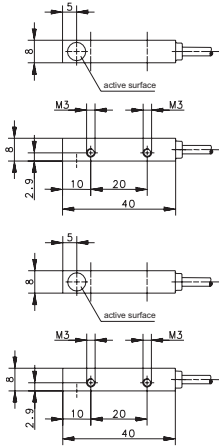

	<b>6373280106</b> MEM-Q08PS/M02-K2		<b>6372255083</b> MEM-Q12PS/H10-KL2 <b>6372155084</b> MEM-Q12P0/H10-KL2 <b>6373455131</b> MEM-Q12PB/H11-KL2			
<b>6362680012</b> MEM-Q08NS/H10-K2		<b>6362655013</b> MEM-Q12NS/H10-K2		<b>6362693010</b> MEK-E27NS/H10-K2		<b>6362611008</b> MEK-E29NS/H10-K2
<b>6363880043</b> MEM-Q08NB/H11-K2		<b>6363855044</b> MEM-Q12NB/H11-K2		<b>6363893041</b> MEK-E27NB/H11-K2	<b>6363893031</b> MEK-E27NB/H02-K2	<b>6363811039</b> MEK-E29NB/H11-K2

4.5–24 VDC	10–30 VDC	4.5–24 VDC	10–39 VDC	4.5–24 VDC	4.5–24 VDC	4.5–24 VDC
25 mA	200 mA	25 mA	400 mA	25 mA	25 mA	25 mA
20 kHz	1500 Hz	20 kHz	10 kHz	20 kHz	20 kHz	20 kHz
-/-	-/-	-/-	LED/-	-/-	-/-	-/-
Current limiter	Cyclic	Current limiter	Cyclic	Current limiter	Current limiter	Current limiter

-25°C/+70°C	-25°C/+70°C	-25°C/+70°C	-25°C/+70°C	-25°C/+70°C	-25°C/+70°C	-25°C/+70°C
IP67	IP67	IP67	IP67	IP67	IP67	IP67
CuZn39Pb3	CuZn39Pb3	CuZn39Pb3	CuZn39Pb3	PA	PA	PA
3 x 0.14 mm <sup>2</sup>	3 x 0.14 mm <sup>2</sup>	3 x 0.14 mm <sup>2</sup>	3 x 0.14 mm <sup>2</sup>	3 x 0.14 mm <sup>2</sup>	3 x 0.14 mm <sup>2</sup>	3 x 0.14 mm <sup>2</sup>

You will find detailed data sheets to the products under [www.bernstein.eu](http://www.bernstein.eu)



# Electronic Magnetic Sensors (Type E45, E50, E90)

Type	E45		E45	E50	
Operating mode	Hall	Hall	MR	Hall	Hall
Magnetic sensitivity (mT)	10 mT	10 mT	3 mT	10 mT	10 mT
Sensing distance (S <sub>n</sub> )	17 mm	17 mm	20 mm	17 mm	17 mm
Reference magnet (Page)	T-62 N/S	T-62 N/S	T-62 N/S	T-62 N/S	T-62 N/S
Type of connection	Cable 2 m	Cable 2 m	Cable 1 m	Cable 2 m	Cable 2 m
Special feature					

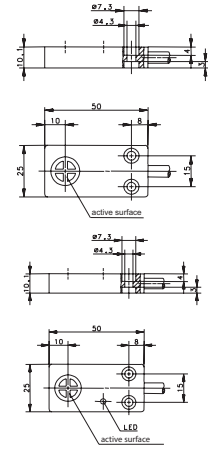
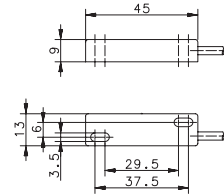
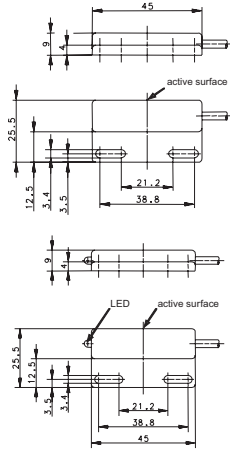

PNP	NO contact Type	<b>6372245079</b> MEK-E45PS/H10-KL2			<b>6372290081</b> MEK-E50PS/H10-KL2
	NC contact Type	<b>6372145080</b> MEK-E45PÖ/H10-KL2			<b>6372190082</b> MEK-E50PÖ/H10-KL2
NPN	Bistable Type	<b>6373445129</b> MEK-E45PB/H11-KL2	<b>6370401203</b> MEK-E45PB/M03-1		<b>6373490130</b> MEK-E50PB/H11-KL2
	LED active surface				
Analogue	Current output	<b>6362645009</b> MEK-E45NS/H10-K2			<b>6362690011</b> MEK-E50NS/H10-K2
	Voltage output	<b>6363845040</b> MEK-E45NB/H11-K2			<b>6363890042</b> MEK-E50NB/H11-K2

### Technical data

Rated operating voltage	U <sub>B</sub>	4.5–24 VDC	10–39 VDC	10–60 VDC	4.5–24 VDC	10–39 VDC
Rated operating current	I <sub>e</sub>	25 mA	400 mA	200 mA	25 mA	400 mA
Max. switching voltage	F	20 kHz	10 kHz	20 Hz	20 kHz	10 kHz
Function/operating voltage indicator		–/–	LED/–	–/–	–/–	LED/–
Sensitivity adjustable						
Short circuit-protection		Current limiter	Cyclic	–	Current limiter	Cyclic
Teachable						

### Mechanical data

Ambient temperature (min/max)		–25°C/+70°C	–25°C/+70°C	–5°C/+70°C	–25°C/+70°C	–25°C/+70°C
Protection class in accordance with IEC 529, EN 60529		IP67	IP67	IP67	IP67	IP67
Enclosure material		PA	PA	PA	PBT	PBT
Connection		3 x 0.14 mm <sup>2</sup>	3 x 0.14 mm <sup>2</sup>	2 x 0,14 mm <sup>2</sup>	3 x 0.50 mm <sup>2</sup>	3 x 0.50 mm <sup>2</sup>

Please refer to Accessories for magnets, mounting brackets, cable couplers and sensor tester.



<b>E90</b>			
MR			
3 mT			
20 mm			
T-62 N/S			
Cable 1 m			

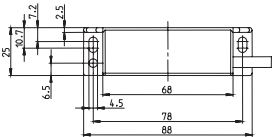
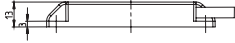

<b>6370442204</b>							
MEK-E90PB/M03-1							

10-60 VDC			
200 mA			
20 Hz			
-/-			
-			

-5°C/+70°C			
IP67			
PA			
2 x 0,50 mm <sup>2</sup>			

You will find detailed data sheets to the products under [www.bernstein.eu](http://www.bernstein.eu)



## Notes

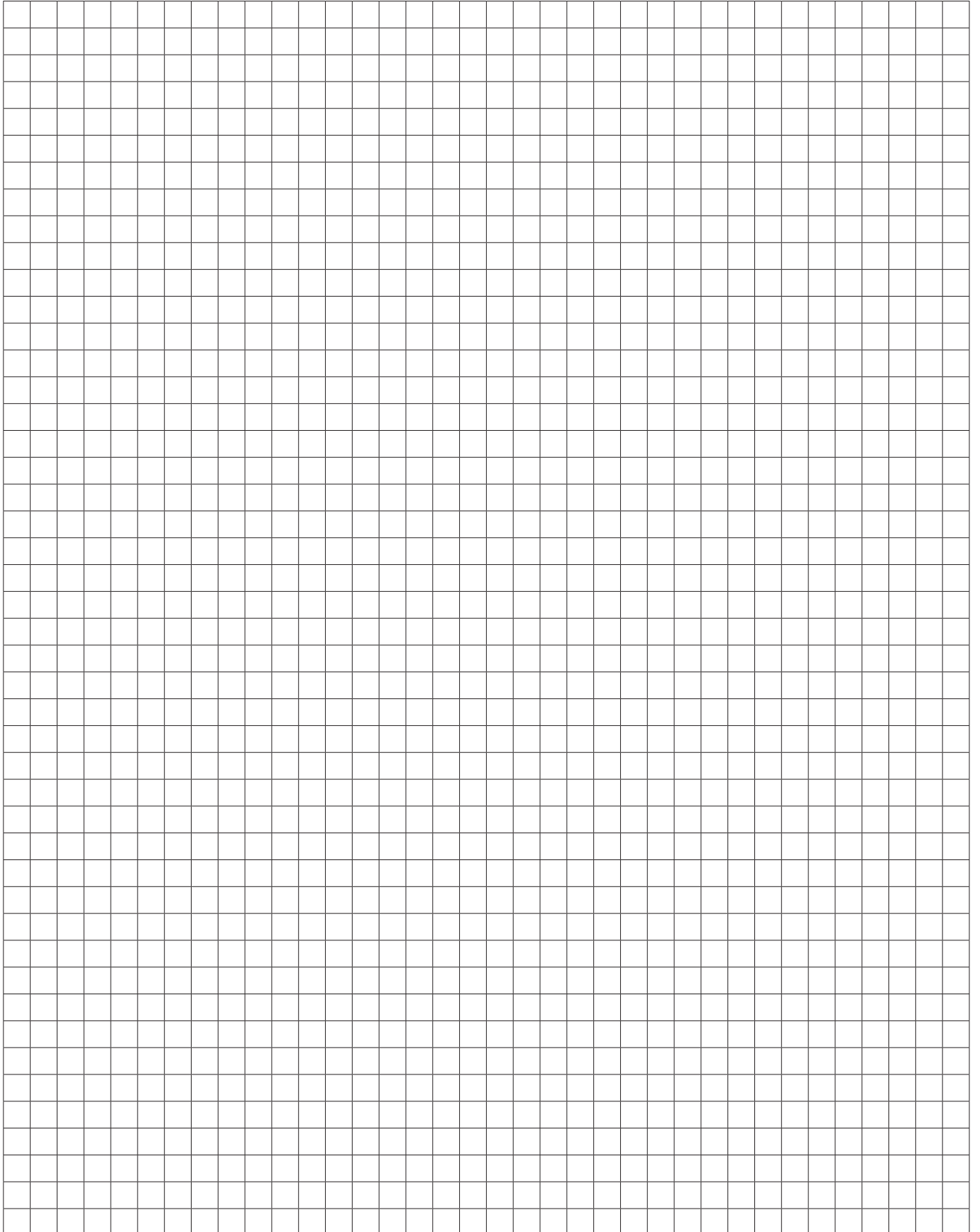

## Programmable Miniature Position Sensors with Fully Integrated Electronics

The teachable magnetic sensors are characterised by one or two freely programmable, independent switching points. Despite this high degree of functionality, BERNSTEIN has succeeded in integrating the entire electronics into a compact sensor enclosure with the smallest possible dimensions. This design feature renders additional protection (e.g. for the cable electronics or high-cost safeguards) unnecessary.

The compact design is suitable for installation in all standard T- and C-slots (e.g. FESTO or SMC). In an installed position, the freely programmable switching points can be quickly and easily set with the aid of the easy-to-use teach-in tool.

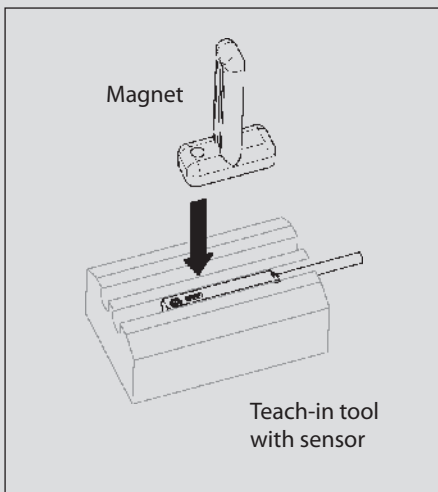

This configuration largely avoids unintentional changes to the settings and substantially increases the resistance to environmental influences while retaining the protection class rating.

Manually searching for the switching points has been replaced by rapid electronic balancing with the sensor installed in position. LEDs at the top of the sensor serve as the function indicator, provide information on the programming status and also signal faults. In addition to featuring effective polarity reversal protection as standard, the sensors also have an internal EEPROM that stores the switching points in the event of power failure.

### Advantages

- Completely integrated electronic solution
- Permanent protection rating
- No need for additional electronics
- Fully immersed and therefore protected installation in the slot
- Suitable for standard C- and T-slots
- Available as cable or plug version
- Occupies only one slot
- Freely programmable switching points
- Straightforward teach-in procedure
- Reduced installation and wiring requirements
- Can be fitted from above
- High switching accuracy

- The installed sensor assumes programming mode when the teach-in tool is placed over it
- The positions of the magnet are assigned to the respective outputs by correspondingly aligning the tool
- The programmable switching points are stored in the sensor
- The switching points can be changed by repeating the teach-in procedure

### Technical data

- PNP/NO contact
- Magnetic sensitivity  $\pm 1.5 \text{ mT}$  to  $\pm 13.5 \text{ mT}$
- Sensing distance up to 50 mm (depending on magnet/air gap)
- Repeat accuracy  $\leq 0.1 \text{ mT}$
- Hysteresis  $1 \text{ mT} \leq H \leq 1.35 \text{ mT}$
- Operating voltage range 10 – 30 V DC
- Output current  $I_e \leq 50 \text{ mA}$  (one output switched)  $\leq 25 \text{ mA}$  per output (both outputs switched)
- Ambient temperature  $-20 \text{ }^\circ\text{C}$  to  $+80 \text{ }^\circ\text{C}$
- Protection class IP67

### Other slot sensors

Sensors with only one output can also be used for applications that require only one switching point. For this purpose BERNSTEIN offers a range of Hall sensors with set sensitivity or reed contact versions that do not require auxiliary energy.

### All sensors come with the following accessories:

- 1x setscrew M2 x 3 (E22), M3 x 6 (E30), DIN 913
- 1x Offset screwdriver (E22)
- 1x Teach-in tool
- 1x Operating and installation instructions

### Standards and approvals

MEK E-22/MEA E30  
EN 60947-5-2



# Teachable Electronic Slot Sensors

Type	E22		E30	
Operating mode	Hall	Hall	Hall	Hall
Magnetic sensitivity (mT)	1.5 – 13.5 mT	1.5 – 13.5 mT	1.5 – 13.5 mT	1.5 – 13.5 mT
Switching function	PNP NO / 0 – 10 V	PNP NO / 0 – 10 V	PNP NO / 0 – 10 V	PNP NO / 0 – 10 V
Reference magnet (Page)				
Type of connection	Cable 2 m	Connector M8	Cable 2 m	Connector M8

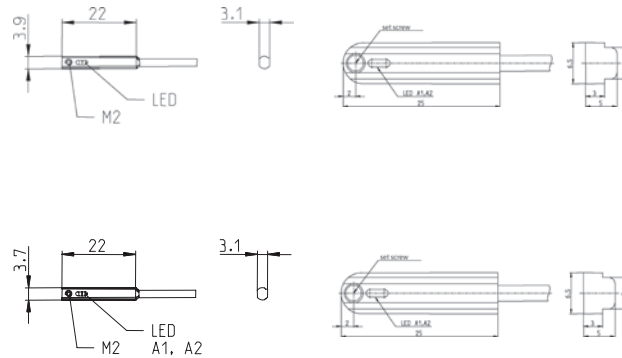

Type	C-slot SMC	<b>6370281183</b>	<b>6370281184</b>		
	Double-channel	MEK-E22PS/HP2-KL2	MEK-E22PS/HP2-KL0,3S8		
Type	C-slot Festo	<b>6370281185</b>	<b>6370281186</b>		
	T-slot	MEK-E22PS/HP2-KL2	MEK-E22PS/HP2-KL0,3S8	<b>6370299187</b>	<b>6370299188</b>
				MEA-E30PS/HP2-KL2	MEA-E30PS/HP2-KL0,3S8
Type	C-slot SMC	<b>6372281177</b>	<b>6372281178</b>		
	Single-channel	MEK-E22PS/HP1-KL2	MEK-E22PS/HP1-KL0,3S8		
Type	C-slot Festo	<b>6372281179</b>	<b>6372281180</b>		
	T-slot	MEK-E22PS/HP1-KL2	MEK-E22PS/HP1-KL0,3S8	<b>6372299181</b>	<b>6372299182</b>
				MEA-E30PS/HP1-KL2	MEA-E30PS/HP1-KL0,3S8
Analogue 0 – 10 V	T-slot				<b>6370099169</b>
	Type				MEA-E30A10/H50-KL0,3S8

## Technical data

Rated operating voltage	$U_b$	10–30 VDC	10–30 VDC	10–30 VDC	10–30 VDC
Rated operating current	$I_e$	≤ 50 mA	≤ 50 mA	≤ 50 mA	≤ 50 mA
Max. switching voltage	F				
Function/operating voltage indicator		LED/–	LED/–	LED/–	LED/–
Sensitivity adjustable		Yes	Yes	Yes	Yes
Short circuit-protection		Cyclic	Cyclic	Cyclic	Cyclic
Teachable		Yes	Yes	Yes	Yes

## Mechanical data

Ambient temperature (min/max)				
<b>Single-channel / Double-channel</b>	–20°C/+80°C	–20°C/+80°C	–20°C/+80°C	–20°C/+80°C
<b>Analogue 1 – 10 V</b>				+5°C/+55°C
Protection class in accordance with IEC 529, EN 60529	IP67	IP67	IP67	IP67
Enclosure material	PA	PA	Aluminium	Aluminium
Connection	4 x 0.05 mm <sup>2</sup>	M8 x 1	4 x 0.05 mm <sup>2</sup>	M8 x 1

Please refer to Accessories for magnets, mounting brackets, cable couplers and sensor tester.





Type	E22		E30	
Operating mode	Hall	Hall	Hall	Hall
Magnetic sensitivity (mT)	3 mT	3 mT	3 mT	3 mT
Switching function	PNP NO	PNP NO	PNP NO	PNP NO
Reference magnet (Page)				
Type of connection	Cable 2 m	Connector M8	Cable 2 m	Connector M8

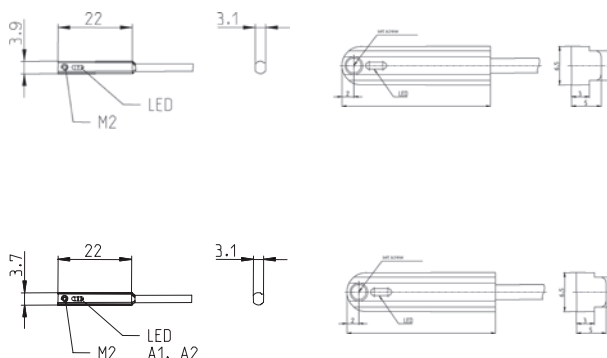

Type	C-slot SMC Type C-slot Festo Type T-slot Type	<b>6372281171</b> MEK-E22PS/H03-KL2  <b>6372281173</b> MEK-E22PS/H03-KL2	<b>6372281172</b> MEK-E22PS/H03-KL0,3S8  <b>6372281174</b> MEK-E22PS/H03-KL0,3S8	<b>6372299175</b> MEA-E30PS/H03-KL2	<b>6372299176</b> MEA-E30PS/H03-KL0,3S8
------	--	--	--	--	--

### Technical data

Rated operating voltage	$U_B$	10–30 VDC	10–30 VDC	10–30 VDC	10–30 VDC
Rated operating current	$I_e$	≤ 50 mA	≤ 50 mA	≤ 50 mA	≤ 50 mA
Max. switching voltage	F				
Function/operating voltage indicator		LED/–	LED/–	LED/–	LED/–
Sensitivity adjustable		Yes	Yes	Yes	Yes
Short circuit-protection		Cyclic	Cyclic	Cyclic	Cyclic
Teachable		–	–	–	–

### Mechanical data

Ambient temperature (min/max)	–20°C/+80°C	–20°C/+80°C	–20°C/+80°C	–20°C/+80°C
Protection class in accordance with IEC 529, EN 60529	IP67	IP67	IP67	IP67
Enclosure material	PA	PA	Aluminium	Aluminium
Connection	3 x 0.05 mm <sup>2</sup>	M8 x 1	3 x 0.05 mm <sup>2</sup>	M8 x 1

Please refer to Accessories for magnets, mounting brackets, cable couplers and sensor tester.



# Slot Sensors with Reed Contact

Type	E22		E30	
Operating mode	Reed	Reed	Reed	Reed
Magnetic sensitivity (mT)	3 mT	3 mT	3 mT	3 mT
Switching function	NO	NO	NO	NO
Switching power	10 VA	10 VA	10 VA	10 VA
Type of connection	Cable 2 m	Connector M8	Cable 2 m	Connector M8

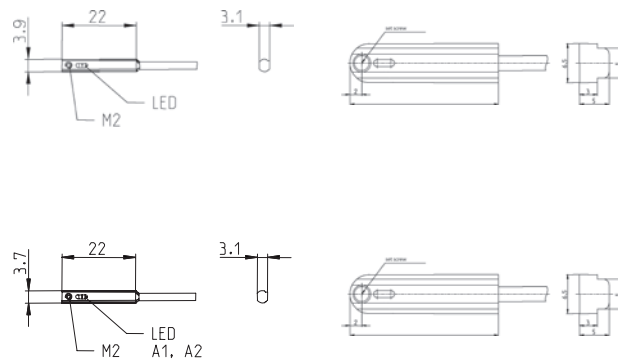

Type	C-slot SMC Type C-slot Festo Type T-slot Type	<b>6310281741</b> MAK-E22S/R20-2	<b>6310281742</b> MAK-E22S/R20-0,3S8	<b>6310281743</b> MAK-E22S/R20-2	<b>6310281744</b> MAK-E22S/R20-0,3S8	<b>6310299745</b> MAA-E30S/R20-2	<b>6310299746</b> MAA-E30S/R20-0,3S8
------	--	-------------------------------------	---	-------------------------------------	---	-------------------------------------	---

## Technical data

Rated operating voltage $U_b$	120 V	120 V	120 V	120 V
Performance class (diagram No.)	10 VA	10 VA	10 VA	10 VA
Shock resistance	30 g (11 ms)	30 g (11 ms)	30 g (11 ms)	30 g (11 ms)
Reproducibility	+/- 1 mm	+/- 1 mm	+/- 1 mm	+/- 1 mm
Mechanical service life (switching operations)	$3 \times 10^8$	$3 \times 10^8$	$3 \times 10^8$	$3 \times 10^8$

## Mechanical data

Ambient temperature (min/max)	-25°C/+80°C	-25°C/+80°C	-25°C/+80°C	-25°C/+80°C
Protection class in accordance with IEC 529, EN 60529	IP67	IP67	IP67	IP67
Enclosure material	PA	PA	Aluminium	Aluminium
Connection	$3 \times 0.05 \text{ mm}^2$	M8 x 1	$3 \times 0.05 \text{ mm}^2$	M8 x 1

You will find detailed data sheets to the products under [www.bernstein.eu](http://www.bernstein.eu)



## Non-contact Safety Sensor SRF



The SRF (Safety RFID) is a non-contact safety sensor, that monitors moveable safety guards, such as doors, flaps and hoods. This particularly compact sensor protects employees from injuries by shutting down or not starting up machines when the safety guard is not properly closed.

**With its innovative diagnostic system, the SRF makes safety circuits suitable for Industry 4.0.**

The system provides a multitude of diagnostic data of each sensor, even in a series connection, to support smart production.

Diagnostic data is fed into the machine control system via I/O Link or alternatively displayed on a smartphone by way of NFC technology. In this way, 20 different diagnostic information of each sensor can be retrieved and made available.

This diagnostic data delivers cost-effective predictive maintenance in a simple way. Through its advanced fault recognition capability, costly machine shutdowns can be prevented.

**This way, your machinery and plant will work even more efficiently!**



### Innovative

- New innovative Daisychain Diagnostics (DCD)
- Reading diagnostics information through Android smartphone via NFC interface
- Transmission of data via I/O Link interface
- Simple and specific maintenance thanks to pre-failure monitoring
- Cost reduction by eliminating machine downtimes
- Connecting the sensor information of six different diagnostic circuits
- Support of an energy-optimised application: Voltage levels known at any time

### Safe

- Safe sensors in Cat. 4, PL e or SIL CL 3
- Safe serial connection of SRF up to PL e, Cat. 4 / SIL CL 3
- Coded and unique actuator

### Versatile

- Protection class of IP69
- Local reset button
- Compact design
- Diagnostics system DCD
- PNP diagnostics
- Fault tolerant output
- Single and series connection possible
- Connection via M12 plug

## Non-contact Safety Sensor SRF

### Benefits and advantages SRF

- **Cost-saving:** thanks to a four-wire unshielded standard connection cable from sensor to sensor ❶
- **Compact:** small in size, flexible in use
- **Safe:** up to PL e – even in series connection, with high defeat protection (according to ISO 14119)
- Series connection of the sensors through internal safety electronics without compromising the safety level

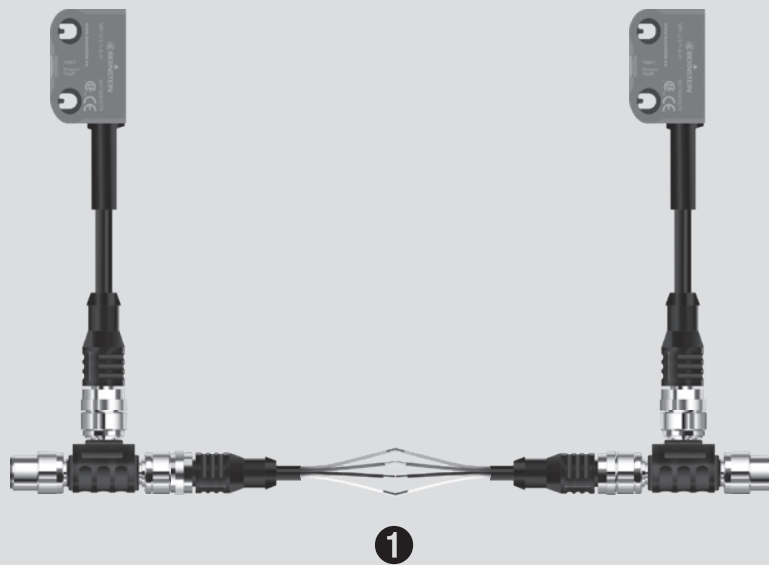

### Coding types

- Low coding level:  
Coded sensor with only one possible code
- High coding level:  
Coded sensor with more than 1000 different codes
- Unique coding: High coding level – but no spare actuator accepted

### Diagnostics (not safety related)

- PNP diagnostics:  
Signalling contact as PNP NO output that indicates whether the safety guard is closed
- DCD System:  
Detailed diagnostic system DCD that submits a complete status image of a sensor, even in series connection

### Reset function

Local reset of the sensor to enable restart of the machine.

### Fault tolerant outputs

The fault tolerant outputs prevent an unexpected machine stop and allow to run down the machine in a controlled manner.

This is how it works:

If an error is detected at one output, the sensor indicates this with a flash code –whilst simultaneously transmitting the information via the DCD system. After 20 minutes, the second still intact output, will switch off.

## Benefits and advantages diagnostics

- Comprehensive diagnostics information for each sensor and for the entire system
- Diagnostic data simply retrievable
- Time and cost savings during commissioning, maintenance and fault investigation
- Protection against unexpected machine stops through pre-fault detection
- Display of diagnostic data on smartphones via NFC
- Simple troubleshooting through reading out the fault memory via NFC also in case of missing power supply

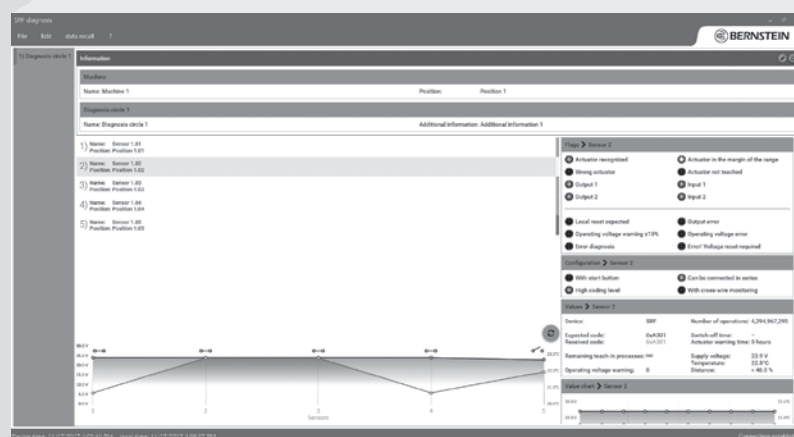
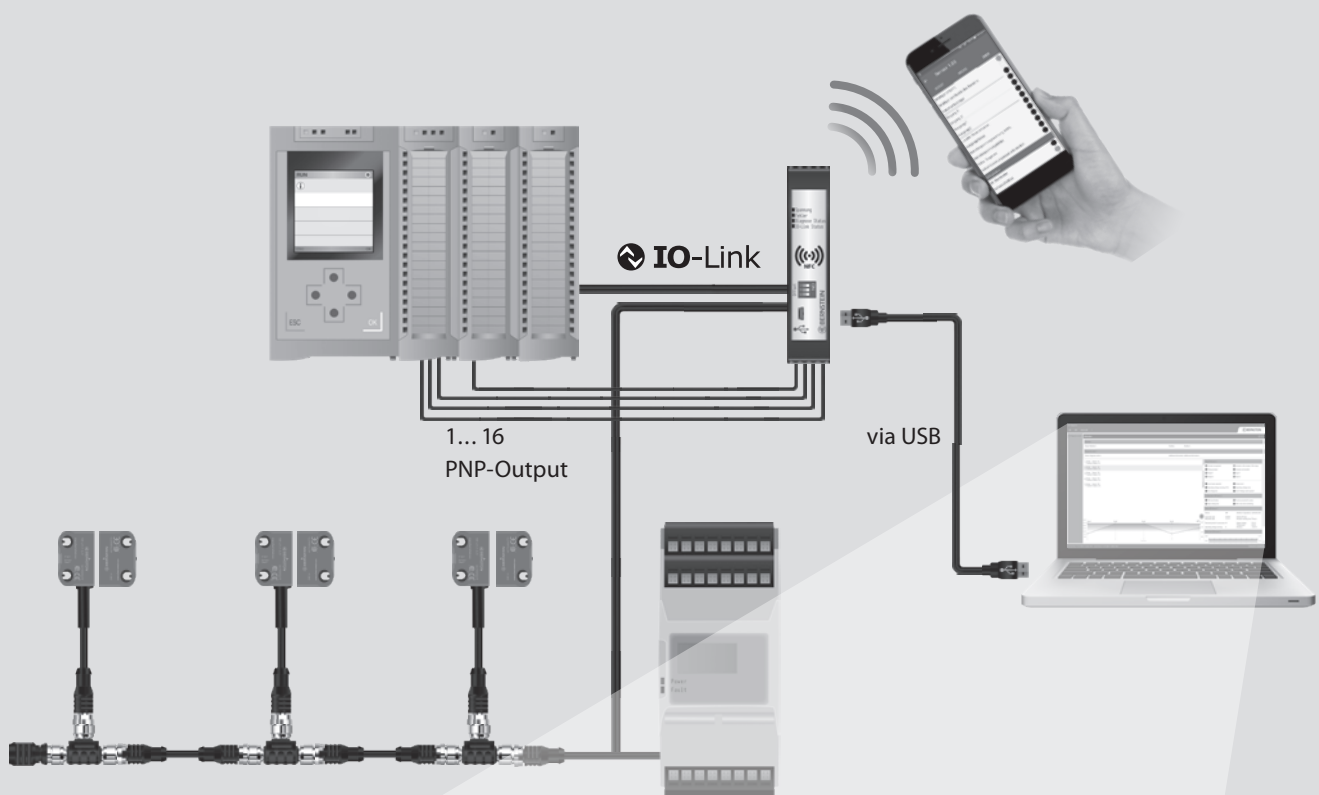

# Non-contact Safety Sensor SRF

## SRF for series connection

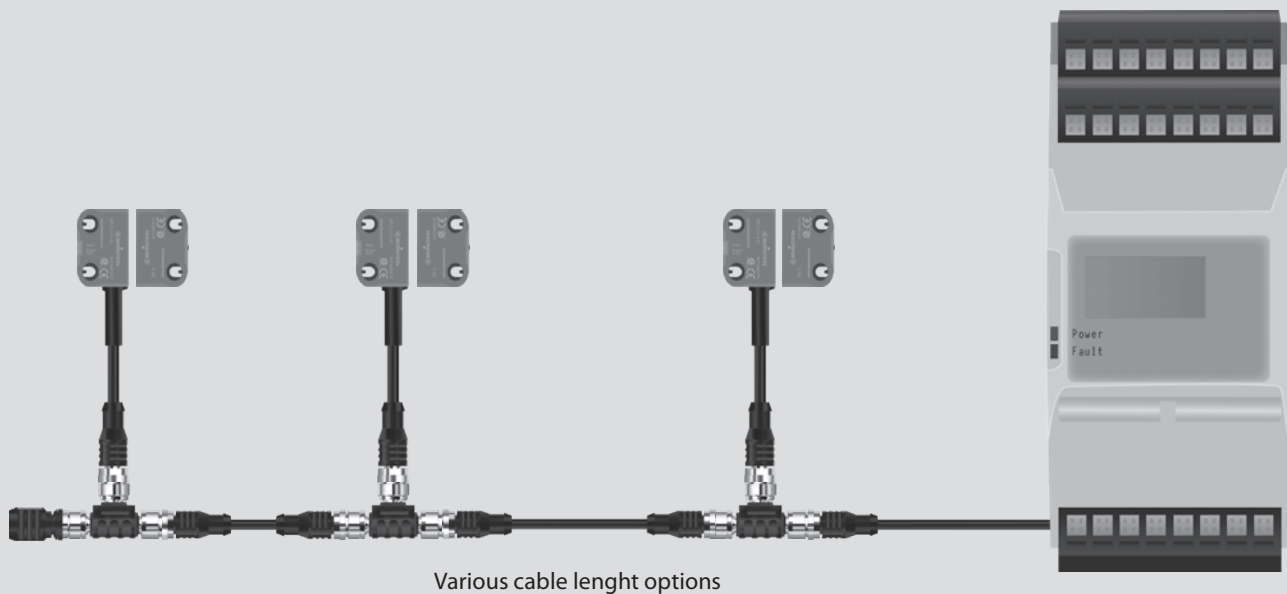

Article number	Designation	Unique	High coding level	Low coding level	PNP diagnostics	Daisychain diagnostics (DCD)	Reset input	M12 8-pin connection with 25 cm cable
6075685094	SRF-4/1/1-E0.25-U	x			x			x
6075685095	SRF-4/1/1-E0.25-H		x		x			x
6075685096	SRF-4/1/1-E0.25-L			x	x			x
6075685097	SRF-4/2/1-E0.25-U	x			x		x	x
6075685098	SRF-4/2/1-E0.25-H		x		x		x	x
6075685099	SRF-4/2/1-E0.25-L			x	x		x	x
6075685100	SRF-5/1/1-E0.25-U	x				x		x
6075685101	SRF-5/1/1-E0.25-H		x			x		x
6075685102	SRF-5/1/1-E0.25-L			x		x		x
6075685080	SRF-5/2/1-E0.25-U	x				x	x	x
6075685103	SRF-5/2/1-E0.25-H		x			x	x	x
6075685104	SRF-5/2/1-E0.25-L			x		x	x	x
6075687078	SRF-0	Actuator SRF, suitable for all coding levels (not included, please order separately)						

## SRF for single connection

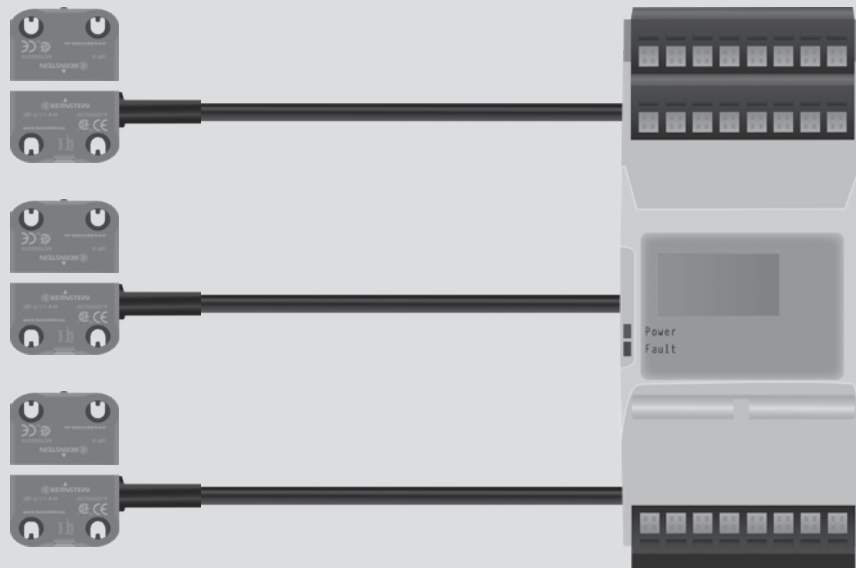

Article number	Designation	Unique	High coding level	Low coding level	PNP diagnostics	M12 5-pin connection with 25 cm cable	2 m cable with open cable end	
6075685117	SRF-2/1/1-A2-U	x			x		x	
6075685079	SRF-2/1/1-A2-H		x		x		x	
6075685118	SRF-2/1/1-A2-L			x	x		x	
6075685119	SRF-2/1/1-E0.25-U	x			x	x		
6075685120	SRF-2/1/1-E0.25-H		x		x	x		
6075685121	SRF-2/1/1-E0.25-L			x	x	x		
6075687078	SRF-0	Actuator SRF, suitable for all coding levels (not included, please order separately)						

# Non-contact Safety Sensor SRF

## Diagnostic module



Article number	Designation	Enclosure	Number of diagnostic circuits	Digital output	Interfaces		
					I/O Link	NFC	USB 2.0
6075619122	SRF DI-C-0/1-T	DIN rail housing 22.5 mm	1	-	X	X	X
6075619123	SRF DI-C-8/1-T	DIN rail housing 22.5 mm	1	8	X	X	X
6075619124	SRF DI-C-16/1-T	DIN rail housing 22.5 mm	1	16	X	X	X
6075619125	SRF DI6-C-0/1-T	DIN rail housing 22.5 mm	6	-	X	X	X
6075689126	SRF DI-F-0/2-E0.25	Rectangular sensor enclosure (use directly at the machine)	1	-	X	X	



## Accessories

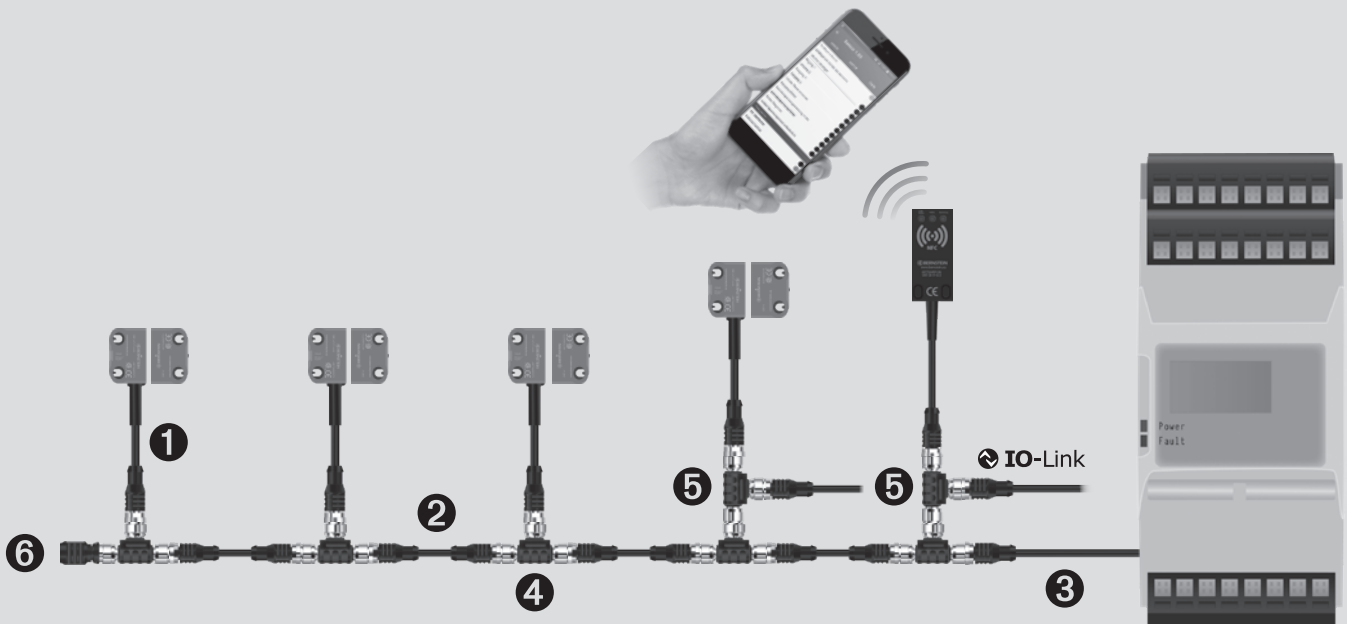

## Connection cable and connecting cable

Pos.-Nr.	Article number	Designation	Description	Plug alignment	Plug 1	Plug 2	Number of plugs	Cable length in meter
1	6075689085	S1W-M12A8/BW-1PU	Connecting cable	straight	M	F	8	1
1	6075689086	S1W-M12A8/BW-2PU	Connecting cable	straight	M	F	8	2
2	6075689087	S1W-M12C4/AW-2PU	Connecting cable	straight	M	F	4	2
2	6075689088	S1W-M12C4/AW-5PU	Connecting cable	straight	M	F	4	5
2	6075689089	S1W-M12C4/AW-10PU	Connecting cable	straight	M	F	4	10
3	6075689092	SFW-M12B5/AW-2PU	Connecting cable	straight	F		5	2
3	6075689093	SFW-M12B5/AW-5PU	Connecting cable	straight	F		5	2
3	6075689090	SFW-M12C4/AW-0.5PU	Connecting cable	straight	F		4	0.5
3	6075689091	SFW-M12C4/AW-2PU	Connecting cable	straight	F		4	2

## T adapter, termination plug and fixing screws

Pos.-Nr.	Article number	Designation	Description
4	6075989082	ATS-M12/4-M12/8	T adapter for series connection
5	6075989083	ATD-M12/8-M12/4	T adapter for connection of I/O link and reset button
6	6075689084	AEP-M12/4	Termination plug M12
	6075689127	AT-CLIP-M12	Fixing clip for T adapter
	6075689128	One-way screw M4 x 16	10 x Fixing screws M4 x 16 One-way screw

# Non-contact Safety Sensor SRF

## Technical data SRF

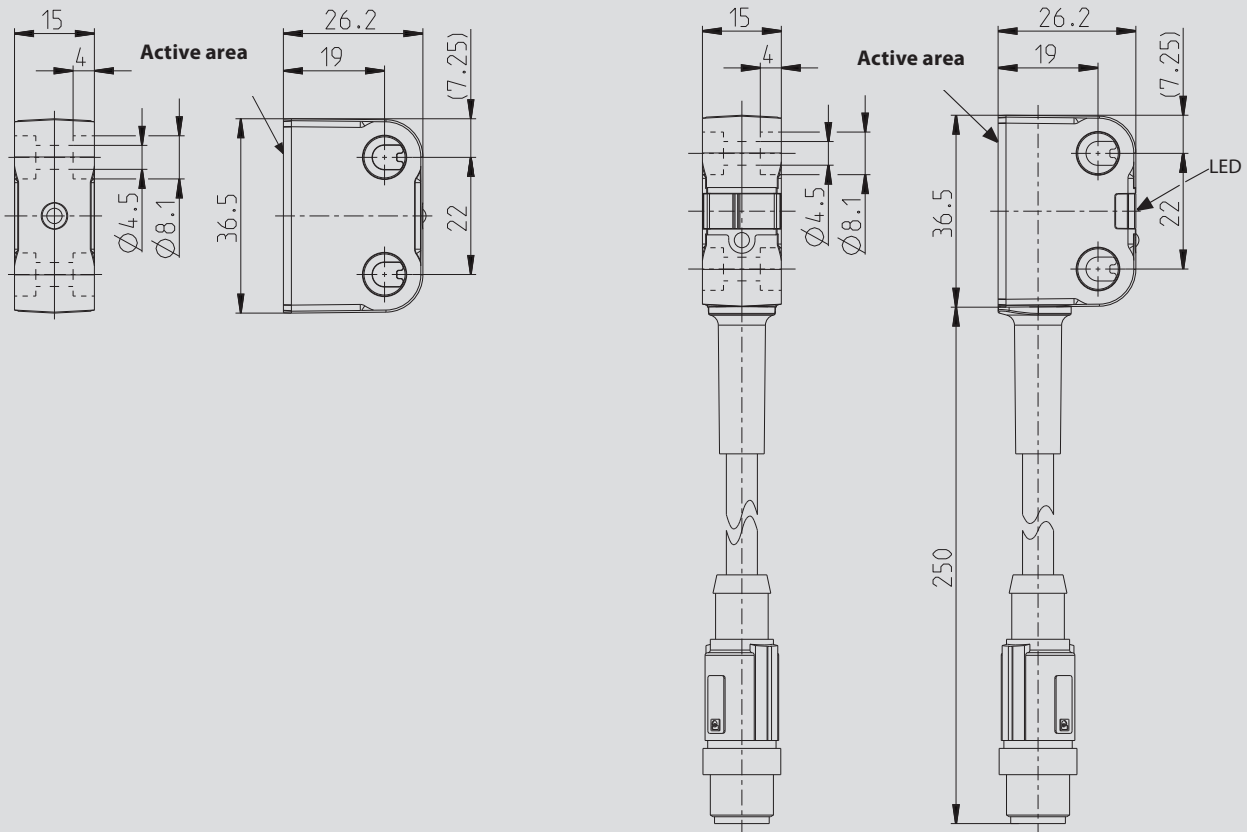

## Electrical data

- Rated operational voltage  $U_e$ : 24 V
- Output current of the safety outputs  $I_e$ : 100 mA
- Output current of the message output  $I_e$ : 10 mA

## Mechanical data

- Housing: PA66 + PA6, red, self-extinguishing
- Connection cable: PUR
- Mounting holes:  $\varnothing$  4,5 (for M4 screws)
- Displays: 1  $\times$  LED red/green operating status  
1  $\times$  LED yellow actuation status
- Ambient temperature: -25 °C to +70 °C
- Protection class: IP69

## Safety data sheet

- PL e / Kat. 4 (according to EN ISO 13849-1)
- SIL CL 3 (according to DIN EN 62061)
- $PFH_D = 6 \times 10^{-9}$  1/h
- Mission time  $T_M$ : 20 years
  
- Switching distance:
  - Rated operating distance  $S_n$ : 13 mm
  - Assured switching distance – On  $S_{ao}$ : 10 mm
  - Assured switching distance – Off  $S_{ar}$ : 25 mm
  - Hysteresis: 2 mm
- Switch-off delay  $t_a$ : max. 100 ms
- Ready delay  $t_v$ : max. 2 s

## Technical data diagnostic module

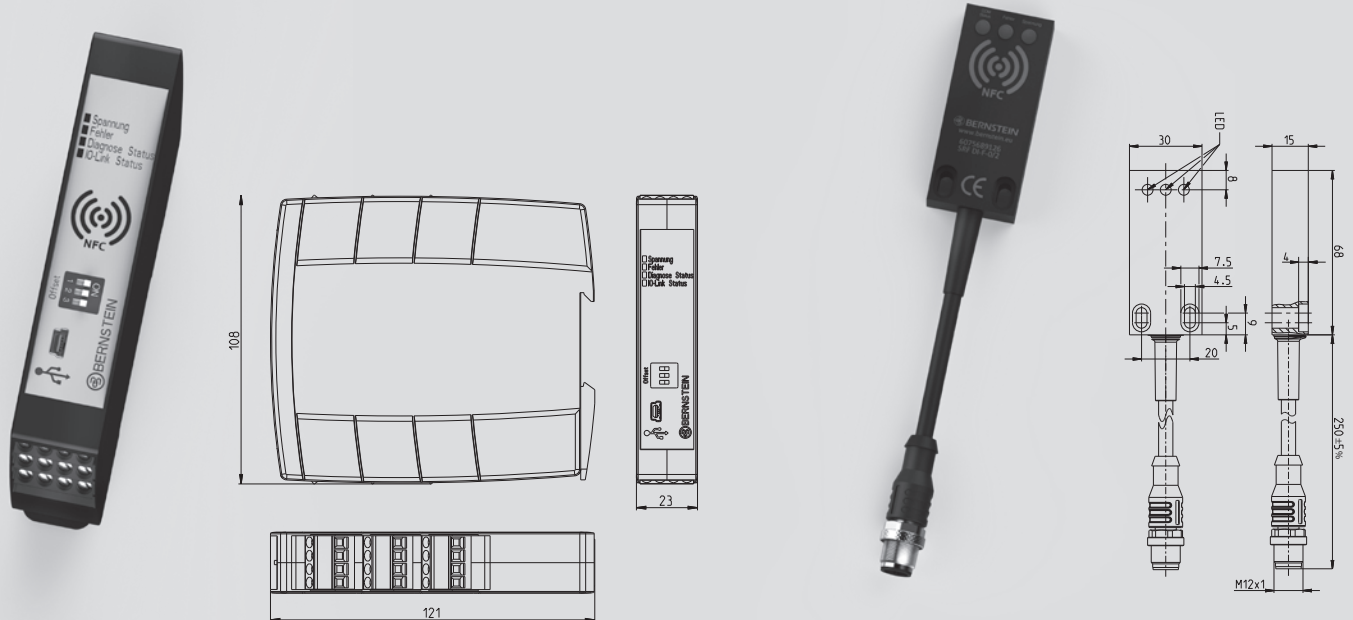

## Cabinet module

- Rated operational voltage  $U_e$ : 24 V DC
- I/O Link protocol: V1.1
- Output current per signal output  $I_e$ : 50 mA
- Ambient temperature: 0 °C to +60 °C
- Protection class: IP20

## Field module

- Rated operational voltage  $U_e$ : 24 V DC
- I/O Link protocol: V1.1
- Output current per signal output  $I_e$ : –
- Ambient temperature: -25 °C to +70 °C
- Protection class: IP69

## Safety relay SCR ON

The SCR ON safety relay monitors the SRF's safety outputs.

### Features

- PL e to ISO 13849
- 3 enabling paths
- Feedback loop with monitored / automatic reset

Article number	Designation
6075111020	SCR ON4-W22-3.6-S



## Safety sensors MAK

To achieve a PL or SIL value with the MAK safety sensors, it is necessary to connect them to a safety evaluation unit. The magnetic safety sensors are dual channel versions. The evaluation unit (BERNSTEIN designation: MÜZ) monitors the correct switching of the two MAK channels and a defined time window in which the two channels must switch.

With the combination of MAK and MÜZ, a PL D and a SIL 3 can be reached. Besides the 3 different types of magnetic safety switches, BERNSTEIN also offers two different evaluation units.

### Product features

- Performance Level d
- Redundancy with NO and NC contacts
- Switching distance: 6 mm
- IP67

### Magnetic controllers for safety functions

BERNSTEIN offers magnetic controllers for safety functions that fulfill performance level d according to EN 13849-1 and SIL 3 according to EN 61508 or rather EN 62061.

A safety system consists of the safety magnetic controllers and a coded transducer unit.

The anti-tamper security of the transducer unit is achieved by variable coding of the actuator magnets and magnetic switches.

Depending on the type of device, one or two coded transducer units (magnetic switch with corresponding magnet) of type:

- MAK-4236
- MAK-5236
- MAK-5336

can be connected to and monitored by the safety magnetic controllers.



MAK-4236-x with magnet TK-42-CD



MAK-5236-x with magnet TK-52-CD / 2



MAK-5336-x with magnet TK-43-CD

The safety magnetic controller processes the NC or NO contact signals coming from the coded magnetic switches. Thereby, it is possible to detect the opening of the safety guard (door, hatch, protective hood etc.) and to turn off the safety output. Thanks to the redundant evaluation, the magnetic controller is switched to the "safe state" should a fault or manipulation occur, or if the time difference is exceeded between the NC contact signal and the NO contact signal. An LED indicates that the safety magnetic controller is in the "safe state".

To ensure fault detection of the switch-off device, the MÜZ-102 offers the possibility to connect a return circuit. The system additionally features a NC contact for signalling purposes.

- Redundancy by NO and NC contacts
- Manipulation safety by coding
- Monitoring of the return circuit (depending on device type)

## Magnetic controllers for safety functions

TÜV certified

- EN ISO 13849-1 Performance Level d
- EN 61508 and EN 62061 SIL 3
- EN 60947-5-3 Single fault security S



## Coded transducer units

Magnetic switches

Type designation	MÜZ-102/D24-FL-DA	MÜZ-202/D24-FL
<b>Article number</b>	<b>6392701306</b>	<b>6392702307</b>
Max. number of connectable transducer units	1	2
Safety output, NO contact	●	●
Feedback circuit	●	-
Data output (NC contact)	●	-
<b>Technical data</b>		
Operating voltage	24 V DC	24 V DC
Operating current	60 mA	60 mA

Type designation	
<b>Article number</b>	
Cable length	
Type designation	
<b>Article number</b>	
Cable length	

Type designation	
<b>Article number</b>	
Cable length	

Type designation	
<b>Article number</b>	
Cable length	

Type designation	
<b>Article number</b>	
Cable length	

<b>Ambient conditions</b>		
Temperature range	min/max	
		0 °C/+55 °C 32 °F/+131 °F
Protection class (to IEC 529, EN 60529)		IP20
Enclosure material		PC
Mounting system (DIN 50022)		TS 35
Type of connection: Terminal block		max. 2.5 mm <sup>2</sup>

<b>Ambient conditions</b>		
Temperature range	min/max	
Protection class (to IEC 529, EN 60529)		
Enclosure material		
Sensing distance	S on	min
	S on	max
<b>Actuating magnet</b>		
Type designation		
<b>Article number</b>		
Use: safety magnetic controller		
<b>Article number</b>		

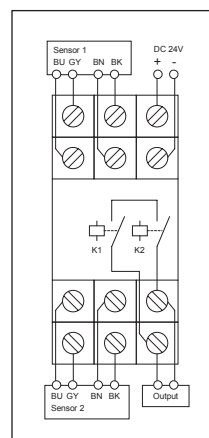
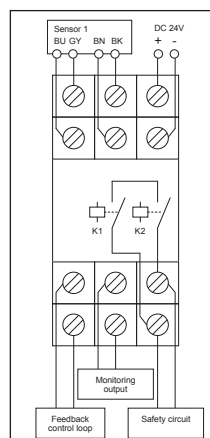
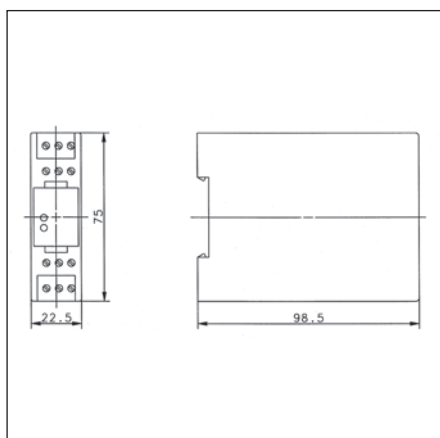

All dimensions in mm

Other types available on request.



MAK-4236-3 <b>6490642315</b> 3 m PVC cable	MAK-5236-3 <b>6490652316</b> 3 m PVC cable	MAK-5336-3 <b>6490653317</b> 3 m PVC cable
MAK-4236-6 <b>6490642302</b> 6 m PVC cable	MAK-5236-6 <b>6490652307</b> 6 m PVC cable	MAK-5336-6 <b>6490653311</b> 6 m PVC cable
MAK-4236-9 <b>6490642303</b> 9 m PVC cable	MAK-5236-9 <b>6490652308</b> 9 m PVC cable	MAK-5336-9 <b>6490653312</b> 9 m PVC cable
MAK-4236-STK <b>6490642305</b> 4-pin connector	MAK-5236-STK <b>6490652309</b> 4-pin connector	MAK-5336-STK <b>6490653313</b> 4-pin connector

-5 °C/+70 °C +23 °F/+158 °F	-5 °C/+70 °C +23 °F/+158 °F	-5 °C/+70 °C +23 °F/+158 °F
IP67	IP67	IP67
PA 6.6	PBT	PA 6.6
4 mm	3 mm	3 mm
14 mm	14 mm	14 mm

TK-42-CD <b>6402042310</b>	TK-52-CD/2 <b>6402052311</b>	TK-43-CD <b>6402043312</b>
<b>6392701306</b>	<b>6392701306</b>	<b>6392701306</b>
<b>6392702307</b>	<b>6392702307</b>	<b>6392702307</b>

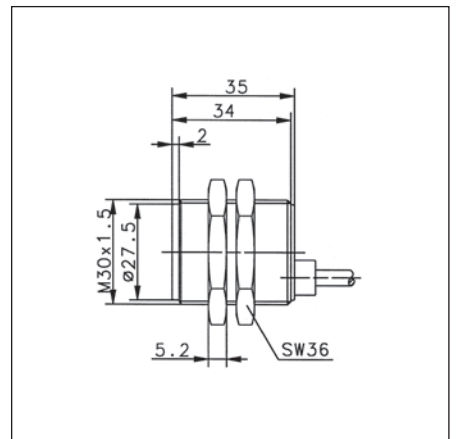
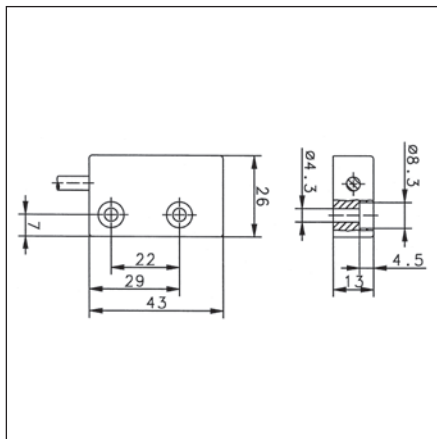
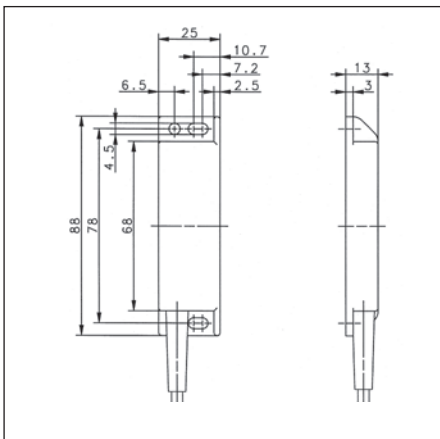



# Accessories

## Magnets

### 1. Hard ferrite magnets

Barium and strontium hard ferrites are economically priced, reliable components that are also widely used in automation, control and measurement applications. When operated in high temperature ranges, the specified switching distance will decrease by a factor of 0.2 % per 1 °C.

Chemical properties:

Ferrite magnets are oxide ceramics. They are made of approx. 80 % iron oxide and 20 % barium oxide or strontium oxide. The magnets are resistant to a large number of chemicals, including solvents, caustic solutions and weak acids. If strong organic and inorganic acids, e.g. hydrochloric, sulphuric and hydrofluoric acid, are used, their resistance will basically be determined by the temperature, concentration and reaction time of the medium. In general, the resistance should first be determined by means of longterm tests.

Mechanical properties:

Due to their ceramic characteristic, ferrites are brittle and sensitive to shock and bending loads.

### 2. Rare-earth magnets

Permanent magnets made from samarium cobalt and neodymium iron boron are high performance and high quality components that are widely used in drive and control engineering. When operated in high temperature ranges, the specified switching distance will decrease by a factor of 0.02 % per 1 °C.

Chemical properties:

All rare-earth magnets are metallic materials and show the corresponding characteristics associated with these materials, e.g. the polished shine immediately after being machined. The magnets are surface-treated (e.g. nickel coating) to protect them from environmental influences.

Mechanical properties:

Minor chips may occur if rare-earth magnets are subjected to impact stress. They respond very sensitively to vibrations and may become demagnetised.

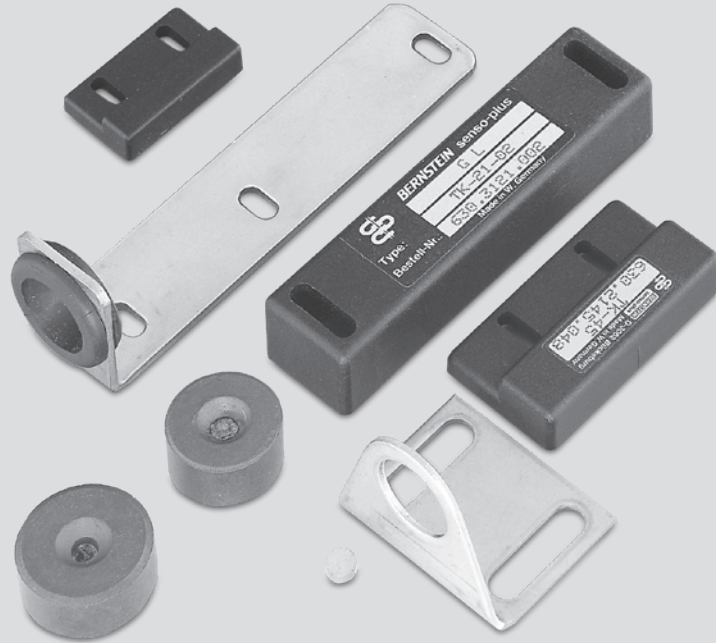

### 3. Plastic-bound magnets

Plastic-bound permanent magnets have an attractive price-performance ratio and thanks to the way they are formed they can be produced with complex geometries.

Injection-moulded magnets are typical composite materials. The magnetic powder is embedded in thermoplastic materials (polyamides). One of the main advantages of plastic-bound magnets is that they can be formed into a diverse range of shapes.

Chemical properties:

Surface corrosion can rarely be found on plastic bound magnets. For this reason, they can be used in most fields of application without additional coating.

Mechanical properties:

Plastic-bound magnets can be subjected to buckling and bending without breaking or chipping.

### Use in potentially explosive atmospheres

Magnets must not be used in potentially explosive atmospheres as they can cause sparks. Grinding dust and chips from rare-earth magnets are self-igniting and burn off at high temperatures. They should therefore only be machined using ample water and never in dry conditions since even dried grinding dust can ignite.

### Strong magnetic fields

Strong magnetic fields can interfere with or even damage electronic or mechanical equipment. This includes cardiac pacemakers. Appropriate safety distances are specified in the corresponding manuals or may be requested from the manufacturers.

### Radioactive radiation

Permanent magnets must not be exposed to longterm radioactive radiation otherwise they may lose their magnetism.



### Effects on persons

There are no known side-effects caused by touching magnet materials.

### Magnet shapes

Rectangular, circular and cylindrical magnets are the most common shapes of permanent magnets manufactured in a press-shaping process. In addition to these standard geometries, permanent magnets may be manufactured in many other shapes. The shape should preferably be defined during the pressing process since subsequent shaping can only be performed using complex diamond tools. Holes and openings can only be made in the pressing direction.

### Directions of magnetisation

The term preferred direction refers to the alignment of the magnetic crystals in a certain direction. The magnet achieves its highest magnetic values in this preferred direction and must therefore be magnetised in this direction.

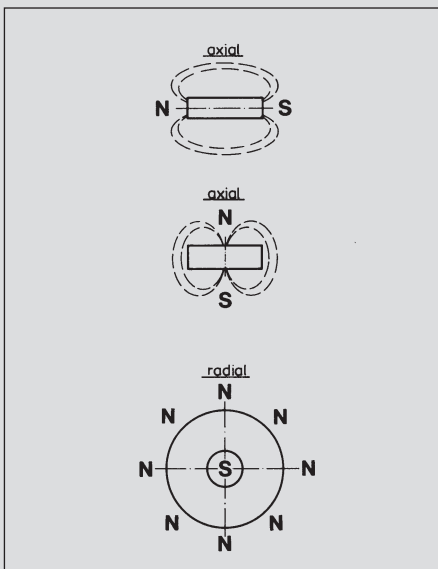

The preferred direction is achieved by subjecting the magnetic powder to a strong external magnetic field (coil) during the pressing process. As magnets have no preferred direction, the magnetisation direction and type can be freely selected.

### Mounting a magnetic switch system on ferromagnetic materials





The nominal distance may be reduced when magnetic limit switches and their actuating magnets are mounted on magnetisable material (Fe, etc.). To ensure trouble-free operation, a minimum gap of 15 mm between the magnetic switch and any material that can be magnetised should be maintained as a reference value. The same applies to the actuating magnets.

### Applications

- Counting
- Position indication in lifts
- End position switches in pneumatic and hydraulic installations
- Position indication on butterfly valves, slide valves and valves in general
- Conveyors in high-bay shelving
- Position detection in textile, packaging and meat cutting machines
- Machine runtime and downtime monitoring
- Control of machine tools
- Level monitoring of liquids (see Float Switches)

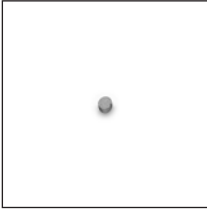
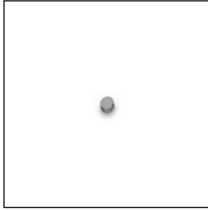
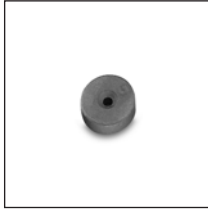
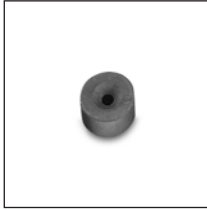
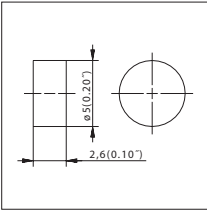
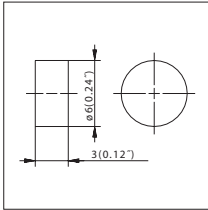
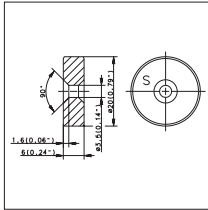
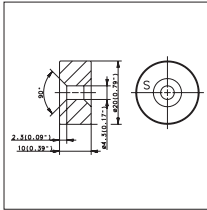
# Accessories

## Actuating Magnets without Encapsulation

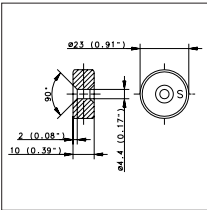
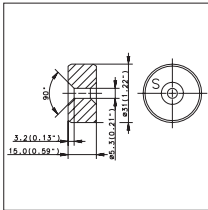
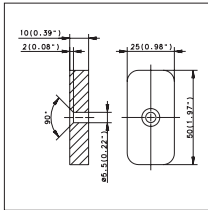
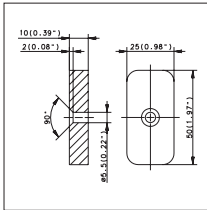



Actuating magnets without encapsulation	T-75	T-06N/S	T-61N/S	T-67N/S
				
Magnet material	Rare-earth	Neodymium iron boron (NdFeB)	Barium ferrite	Barium ferrite
Temperature range (magnetic switch operation)	-40 °C ... +150 °C -40 °F ... +302 °F	-40 °C ... +150 °C -40 °F ... +302 °F	-40 °C ... +150 °C -40 °F ... +302 °F	-40 °C ... +150 °C -40 °F ... +302 °F
Temperature coefficient	0.2 %/K	0.2 %/K	0.2 %/K	0.2 %/K
Enclosure material	-	-	-	-
Article number	<b>6301175057</b>	<b>6301106065</b>	<b>6301261035</b>	<b>6301167054</b>
Dimensioned drawing				
		Marking slots on north pole side		
Actuating magnets without encapsulation	T-62N/S	T-69N/S	T-68N	T-68S
				
Magnet material	Barium ferrite	Barium ferrite	Barium ferrite	Barium ferrite
Temperature range (magnetic switch operation)	-40 °C ... +150 °C -40 °F ... +302 °F	-40 °C ... +150 °C -40 °F ... +302 °F	-40 °C ... +150 °C -40 °F ... +302 °F	-40 °C ... +150 °C -40 °F ... +302 °F
Temperature coefficient	0.2 %/K	0.2 %/K	0.2 %/K	0.2 %/K
Enclosure material	-	-	-	-
Article number	<b>6301262039</b>	<b>6301269031</b>	<b>6301268028</b>	<b>6301368033</b>
Dimensioned drawing				
			90° countersink on north pole side	90° countersink on south pole side

# Actuating Magnets in Plastic Enclosure

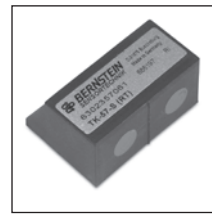
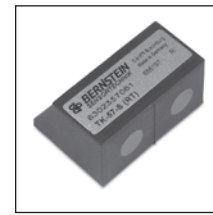
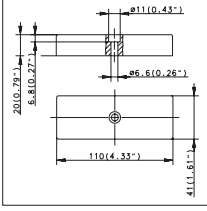
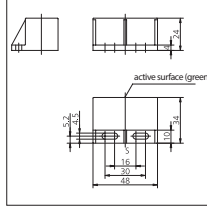
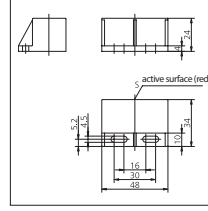

Actuating magnets in plastic enclosure	TK-11-11	TK-11-01	TK-21-02	TK-21-12
Magnet material	AlNiCo-500	AlNiCo-500	AlNiCo-500	AlNiCo-500
Temperature range (magnetic switch operation)	-20 °C ... +80 °C -4 °F ... +176 °F	-20 °C ... +80 °C -4 °F ... +176 °F	-20 °C ... +80 °C -4 °F ... +176 °F	-20 °C ... +80 °C -4 °F ... +176 °F
Temperature coefficient	0.2 %/K	0.2 %/K	0.2 %/K	0.2 %/K
Enclosure material	PA 6.6	PA 6.6	PA 6.6	PA 6.6
Article number	<b>6302111047</b>	<b>6303111001</b>	<b>6303121002</b>	<b>6302121030</b>
Dimensioned drawing				
Actuating magnets in plastic enclosure	TK-45	TK-42	TK-44	
Magnet material	AlNiCo-500	AlNiCo-500	AlNiCo-500	
Temperature range (magnetic switch operation)	-20 °C ... +80 °C -4 °F ... +176 °F	-20 °C ... +80 °C -4 °F ... +176 °F	-20 °C ... +80 °C -4 °F ... +176 °F	
Temperature coefficient	0.2 %/K	0.2 %/K	0.2 %/K	
Enclosure material	PA 6.6	PA 6.6	PA 6.6	
Article number	<b>6302145048</b>	<b>6302142049</b>	<b>6302144050</b>	
Dimensioned drawing				

# Accessories

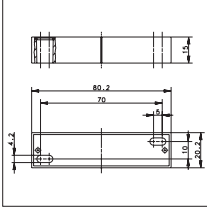
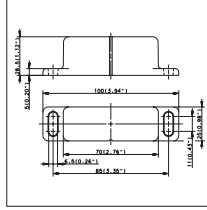
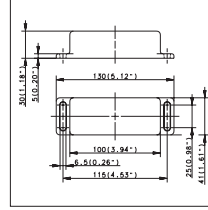
## Actuating Magnets



Actuating magnets in plastic enclosure	TK-50	TK-57N	TK-57S
			
Magnet material	Barium ferrite	Barium ferrite	Barium ferrite
Temperature range (magnetic switch operation)	-20 °C ... +80 °C -4 °F ... +176 °F	-20 °C ... +80 °C -4 °F ... +176 °F	-20 °C ... +80 °C -4 °F ... +176 °F
Temperature coefficient	0.2 %/K	0.2 %/K	0.2 %/K
Enclosure material	PA 6.6	PBT	PBT
Article number	6302100053	6302257060	6302357061
Dimensioned drawing			
Actuating magnets in metal enclosure	TA-21-02	TA-31	TA-33
			
Magnet material	AlNiCo-500	AlNiCo-500	Barium ferrite
Temperature range (magnetic switch operation)	-40 °C ... +150 °C -40 °F ... +302 °F	-20 °C ... +80 °C -4 °F ... +176 °F	-20 °C ... +80 °C -4 °F ... +176 °F
Temperature coefficient	0.2 %/K	0.2 %/K	0.2 %/K
Enclosure material	Al	Al	Al
Article number	6305121064	6303131005	6303133034
Dimensioned drawing			

## Mounting Brackets



Mounting brackets	BWN-M06NI/40 x 47	BWN-M06NI/27 x 38	BWN-M36NI
			
Material	Niro 1.4301	Niro 1.4301	Niro 1.4301
For series	MA-06, MA-16, MA-26, MA-15	MA-06, MA-16, MA-26, MA-15	MA-06, MA-16, MA-26, MA-15
<b>Article number</b>	<b>4102802001</b>	<b>4102802002</b>	<b>4904700035</b>
Dimensioned drawing			



## Accessories

### Miniature Snap-In Connectors

Miniature snap-in connectors	Ø 6.5 mm	Ø 6.5 mm
<b>Contact assignments</b> 1 = Brown 2 = Black 3 = Blue		
		
Cable material	PUR	PUR
Coupler material	PA 12	PA 12
Coupling ring material	POM	POM
Temperature range	-25 °C ... +90 °C -13 °F ... +194 °F	-25 °C ... +90 °C -13 °F ... +194 °F
Switching function	Universal	Universal
Cable structure	3 x 0.25 mm <sup>2</sup>	3 x 0.25 mm <sup>2</sup>
Protection class	IP67/NEMA 4	IP67/NEMA 4
<b>Article number</b>	<b>4139100219</b>	<b>4139100221</b>
Type	GDK-R06US/SO0-2,5PU	WDK-R06US/SO0-2,5PU
	<b>4139100220</b>	<b>4139100222</b>
Type	GDK-R06US/SO0-5PU	WDK-R06US/SO0-5PU
	<b>4139100267</b>	<b>4139100267</b>
Type		WDK-R06US/SO0-10PU

### Connectors

Cable connector M8 x 1	M8	M8	M8
<b>Contact assignments</b> 1 = Brown 2 = Black 3 = Blue			
Cable material	PVC	PVC	PVC
Coupler material	TPU	PUR	PUR
Coupling ring material	CuZn39Pb3	CuZn39Pb3	CuZn39Pb3
Temperature range	-25/+90 °C	-25/+90 °C	-25/+90 °C
Switching function	PNP/LED	Universal	Universal
Cable structure	3 x 0.25 mm <sup>2</sup>	3 x 0.25 mm <sup>2</sup>	3 x 0.25 mm <sup>2</sup>
Protection class	IP67	IP67	IP67
<b>Article number</b>	<b>4139100213</b>	<b>4139100795</b>	<b>4139100798</b>
Type	WDK-M08PS/LL2-2	GDK-M08US/WO0-2	WDK-M08US/WO0-2
	<b>4139100216</b>	<b>4139100796</b>	<b>4139100799</b>
Type	WDK-M08PS/LL2-5	GDK-M08US/WO0-5	WDK-M08US/WO0-5
		<b>4139100797</b>	<b>4139100800</b>
Type		GDK-M08US/WO0-10	WDK-M08US/WO0-10

Cable connector M12 x 1	M12 3-wire	M12 3-wire	M12 4-wire	M12 4-wire
<b>Contact assignments</b> 1 = Brown 2 = White 3 = Blue 4 = Black				
Cable material	PVC	PVC	PVC	PUR
Coupler material	PUR	PUR	PA	PUR
Coupling ring material	CuZn39Pb3	CuZn39Pb3	CuZn39Pb3	CuZn39Pb3
Temperature range	-25/+90 °C	-25/+90 °C	-25/+90 °C	-25/+90 °C
Switching function	Universal	Universal	Universal	PNP/LED
Cable structure	3 x 0.34 mm <sup>2</sup>	3 x 0.34 mm <sup>2</sup>	4 x 0.25 mm <sup>2</sup>	4 x 0.25 mm <sup>2</sup>
Protection class	IP67	IP67	IP67	IP67
<b>Article number</b>	<b>4139100801</b>	<b>4139100804</b>		<b>4139100244</b>
Type	GDK-M12US/WO0-2	WDK-M12US/WO0-2		WDK-M12PA/SL2-2PU
<b>5 m</b>	<b>4139100802</b>	<b>4139100468</b>	<b>4139100903</b>	<b>4139100245</b>
Type	GDK-M12US/WO0-5	WDK-M12US/WO0-5	WDK-M12UA/WO0-5	WDK-M12PA/SL2-5PU
<b>10 m</b>	<b>4139100803</b>	<b>4139100805</b>	<b>4139100467</b>	<b>4139100254</b>
Type	GDK-M12US/WO0-10	WDK-M12US/WO0-10	WDK-M12UA/WO0-10	WDK-M12PA/SL2-10PU

Cable connector M12 x 1	M12	M12	M12 3-wire	M12 5-wire
<b>Contact assignments</b> 1 = Brown 2 = White 3 = Blue 4 = Black				
Cable material	-	-	PVC	PUR
Coupler material	PA	PA	TPU	PUR
Coupling ring material	CuZn39Pb3	CuZn39Pb3	CuZn39Pb3	CuZn39Pb3
Temperature range	-25/+90 °C	-25/+90 °C	-25/+90 °C	-25/+90 °C
Switching function	Universal	Universal	PNP/LED	Universal
Cable structure	-	-	3 x 0.4 mm <sup>2</sup>	5 x 0.34 mm <sup>2</sup>
Protection class	IP67	IP67	IP67	IP67
<b>Article number</b>	<b>4139100102</b>	<b>4139100101</b>	<b>4139100553</b>	<b>4139100956</b>
Type	GDA-M12UA/LO	WDA-M12UA/LO	WDK-M12PS/LL2-2	GDK-M12UU/HO-2PU
<b>5 m</b>			<b>4139100554</b>	
Type			WDK-M12PS/LL2-6	
<b>10 m</b>				
Type				





## Mounting Brackets

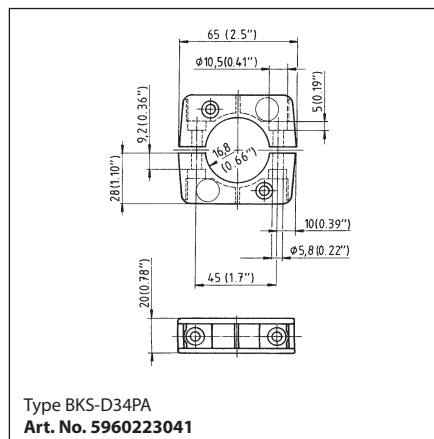
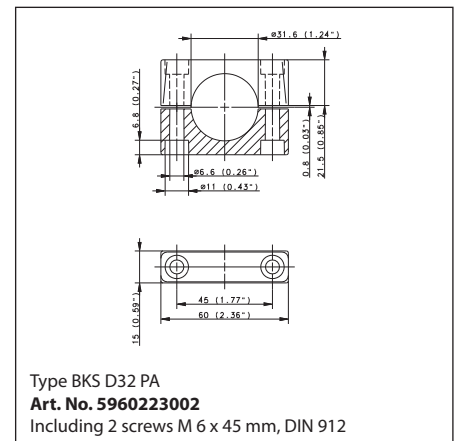
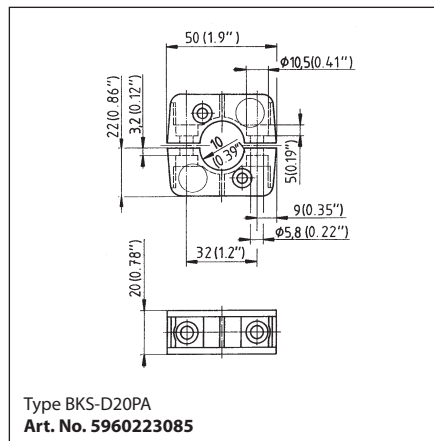

# Accessories

## Sensor Tester



Technical data	
Type designation	Sensor Tester
Article number	<b>651000048</b>
Function	Sensor tester for DC 2-wire and 3-wire proximity switches Test function: Checking and indicating the switching status of a sensor with visual and acoustic signal
Power supply	9 V block battery (6LR61)
Output voltage	15 VDC, 20 mA stabilised
Enclosure	Modified enclosure of Series OR20
Temperature range	-25 °C/+70 °C
Input signals	NPN/PNP 3-wire, DC 2-wire, NAMUR

The sensor tester is used for checking 2-wire and 3-wire DC proximity switches. Coloured LEDs and an acoustic signal are used to indicate the switching statuses.

- Green LED: Operating voltage
- Red LED: Low battery
- Yellow LED: Sensor switching status

When not in use, the sensor tester switches off automatically after approx. 30 s.

### Connection assignments

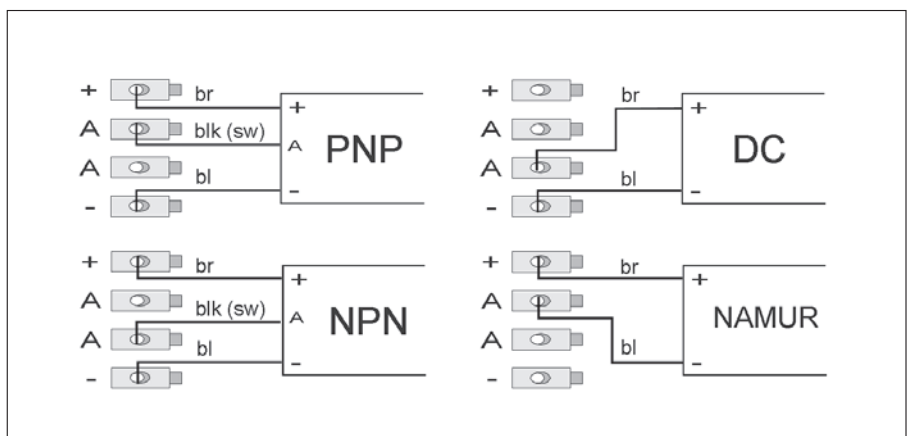



# Type Code

## Inductive Sensors

1	2	3	4	5	6	7	8	9	10	11	12	13	14	15	16	17	18	19	+
<b>K</b>	<b>I</b>	<b>N</b>	<b>-</b>	<b>T</b>	<b>1</b>	<b>2</b>	<b>N</b>	<b>S</b>	<b>/</b>	<b>0</b>	<b>0</b>	<b>4</b>	<b>-</b>	<b>K</b>	<b>L</b>	<b>2</b>			
Product group			Type of enclosure				Output		Sensing distance				Options						

Product group		
1	K	Non-contact proximity switch
2	I	Inductive
3	B	Flush mount
	N	Non-flush mount
	R	Ring sensor
4	-	Dash (fixed)
Type of enclosure		
5	M	Metric thread (metal enclosure)
	T	Metric thread (plastic enclosure)
	D	Round enclosure (metal)
	R	Round enclosure (plastic)
	Q	Cuboid enclosure (metal)
	P	PG thread (metal)
	E	Rectangular enclosure (plastic)
	S	Slot proximity switch (plastic)
	N	Standard mounting (to DIN 50025/50037)
	C	Compact enclosure
6 – 7		Two-digit number for:
		Round types = Ø as specified
		Threaded types = standard designation
		Rectangular types = consecutive type numbers

Design examples		
	D08	Ø 8 mm (metal)
	R22	Ø 22 mm (plastic)
	M12	Threaded barrel M12 x 1
Rectangular and other types		
	E16	16 x 5 x 5 mm
	E27	27 x 10 x 5.5 mm
	E28	28 x 16 x 11 mm
	E40	40 x 26 x 12 mm
	E50	50 x 25 x 10 mm
	E68	68 x 30 x 15 mm
	G00	Tube thread, general
	N44	41.5 x 41.5 x 120 mm
	Q05	5 x 5 x 25 mm
	Q08	8 x 8 x 40 mm, Side active
	Q12	12 x 12 x 55 mm

Output		
8	P	PNP
	N	NPN
	A	AC 2-wire
	E	NAMUR
	Z	DC 2-wire
	R	Relay
	G	Push-pull
	D	Dual output stage (NPN/PNP selectable)
9	S	NO contact
	Ö	NC contact
	P	Programmable
	A	Analogue
	U	Antivalent (selectable)
10	/	Slash (fixed)
Sensing distance		
11 – 13	f. ex. 1.5	1.5 mm
	f. ex. 002	2.0 mm
	f. ex. 040	40 mm
14	-	Dash (fixed)
Options		
15 – 17		See type code "OPTIONS", p. 106

## Capacitive Sensors

1	2	3	4	5	6	7	8	9	10	11	12	13	14	15	16	17	18	19	+
K	C	N	-	T	1	2	N	S	/	0	0	4	-	K	L	P	2		
Product group			Type of enclosure				Output		Sensing distance				Options						

Product group		
1	K	Non-contact proximity switch
2	C	Capacitive
3	B	Flush mount
	N	Non-flush mount
4	-	Dash (fixed)
Type of enclosure		
5	M	Metric thread (metal enclosure)
	T	Metric thread (plastic enclosure)
	D	Round enclosure (metal)
	R	Round enclosure (plastic)
	Q	Cuboid enclosure (metal)
	P	PG thread (metal)
	E	Rectangular enclosure (plastic)
	N	Standard mounting (to DIN 50025/50037)
6-7		Two-digit number for:
		Round types = Ø as specified
		Threaded types = standard designation
		Rectangular types = consecutive type numbers

Design examples		
	12	Thread M12 x 1
	18	Thread M18 x 1
	30	Thread M30 x 1,5
	32	Thread M32 x 1,5
	34	Ø 34 mm (metal/plastic)
	20	Ø 20 mm (plastic)
	22	Ø 22 mm (plastic)
	50	50 x 25 x 10 mm
	68	68 x 30 x 15 mm
	44	41.5 x 41.5 x 120 mm (Euro standard enclosure)
Output		
8	p	PNP
	N	NPN
	A	AC 2-wire
	E	NAMUR
	Z	DC 2-wire
	R	Relay
	G	Push-pull
	D	Dual output stage (NPN/PNP selectable)

Output		
9	S	NO contact
	Ö	NC contact
	P	Programmable
	A	Analogue
	U	Antivalent (selectable)
10	/	Slash (fixed)
Sensing distance		
11-13	e.g. 1.5	1.5 mm
	e.g. 002	2.0 mm
	e.g. 040	40 mm
14	-	Dash (fixed)
Options		
15-19		See type code "OPTIONS", p. 106

# Magnetic Switches

1	2	3	4	5	6	7	8	9	10	11	12	13	14	15	16	17		
<b>M</b>	<b>A</b>	<b>K</b>	<b>-</b>	<b>0</b>	<b>1</b>	<b>1</b>	<b>2</b>	<b>-</b>	<b>D</b>	<b>-</b>	<b>1</b>	<b>-</b>	<b>S</b>	<b>O</b>	<b>K</b>			
Product group			Type			Contact specifications				Cable length			Special features					

Product group		
1	M	Magnetic switch
2	Type of output	
	A	Reed contact
	R	Relay
3	Enclosure material	
	A	Aluminium
	N	Stainless steel
	M	Brass, nickel-plated
	K	Plastic, general
	O	Other materials
4	-	Dash (fixed)
Type		
5 – 6	01 – 99	Cylindrical and rectangular types (see next page for details)
Contact specifications		
7	Number of contacts	
	e.g. 1	1 Reed contact
	e.g. 2	2 Reed contacts
	...	etc.

8	Contact function	
	1	NC contact
	2	NO contact
	3	Changeover contact
	4	Bistable (ON/OFF)
	5	Bistable (changeover contact)
	6	NC, NO contact; separate contacts
	7	Coded, BG
	8	Currently not used
	9	Currently not used
	0	Other outputs
9	-	Dash (fixed)
10	Contact type/power of reed contacts	
	A	250 VDC ; 0.5 A; 20 VA
	B	250 VDC ; 0.5 A; 10 VA
	C	250 VDC ; 0.5 A; 30 VA
	D	250 VDC ; 0.5 A; 30 VA
	E	250 VDC ; 1.5 A; 30 VA
	F	250 VDC ; 3.0 A; 100 VA
	G	250 VDC ; 5.0 A; 250 VA
	H	250 VDC ; 1.0 A; 60 VA
	K	250 VDC ; 0.5 A; 30 VA
	L	250 VDC ; 1.0 A; 60 VA
	M	250 VDC ; 1.0 A; 80 VA
	N	250 VDC ; 1.0 A; 60 VA
	O	120 VDC ; 0.5 A; 10 VA
	P	250 VDC ; 5.0 A; 250 VA
	R	28 VDC ; 0.25 A; 3 VA
	W	250 VDC ; 1.0 A; 60 VA
	X	100 VDC ; 0.25 A; 5 VA
	Y	100 VDC ; 0.5 A; 10 VA

TRIAC		
	K	24 – 250 VDC ; 1.5 A a. 300 VA b. 330 VA
	Hall	
11	-	Dash (fixed)
Cable length in metres		
12	e.g. 1	1 m cable
	e.g. 2	2 m cable
	...	etc.
13	-	Dash (fixed)
Special features		
14 – 17	T	Temperature resistant from -40 °C to +150 °C
	SI	With miniature fuse
	VDR	With VDR
	WID	With resistor
	LED	With LED
	SPK	Spiral cable
	SK	Special cable
	SOK	Connector type without head (without device socket)
	SMK	Connector type with head (with device socket)
	PG11	Type of thread
	RZ	Time delay with relay
	220 V	220 Volt version
	24 V	24 Volt version
	STK	Connector

## Magnetic Switches

1	2	3	4	5	6	7	8	9	10	11	12	13	14	15	16	17		
<b>M</b>	<b>A</b>	<b>K</b>	<b>-</b>	<b>0</b>	<b>1</b>	<b>1</b>	<b>2</b>	<b>-</b>	<b>D</b>	<b>-</b>	<b>1</b>	<b>-</b>	<b>S</b>	<b>O</b>	<b>K</b>			
Product group			Type			Contact specifications				Cable length			Special features					

Type		
5 – 6	01 – 99	Cylindrical and rectangular types
	01	45 x 13 x 9 mm [MA-01] PA
	02	80 x 20 x 15 mm [MA-02] PA/AL
	03	110 x 58 x 29 mm [MA-03] AL
	04	∅ 15.5 x 87 mm [MA-04] PC
	05	Currently not used
	06	∅ 12 x 81 mm [MA-06] AL
	07 – 10	Currently not used
	11	28.6 x 18 x 6.4 mm [MA-11] PA
	12	80 x 20 x 15 mm [MA-12] PA
	13	68 x 30 x 15 mm [MA-13] PC
	14	Currently not used
	15	∅ 12 x 81 mm [MA-15] PA
	16	∅ 12 x 81 mm [MA-13] VA
	17	PG9 x 60 mm [MA-17] PA
	18	M12 x 1 x 60 mm [MA-18] Ms
	19	M18 x 1 x 80 mm [MA-19] Ms
	20	Currently not used
	21	PG9 x 80 mm [MA-21] PA
	22	Currently not used
	23	M12 x 1 x 80 mm [MA-23] Ms
	24/25	Currently not used
	26	∅ 12 x 81 mm [MA-26] PA
	27	Currently not used
	28	M12 x 1 x 60 mm [MA-28] PA
	29	M18 x 1 x 80 mm [MA-29] PA
	30	∅ 6 x 30 mm [MA-30] PA
	31	Currently not used
	32	85 x 26 x 26 mm [MA-32] PBT
	33	M12 x 1 x 80 mm [MA-33] PA
	34/35	Currently not used

	36	∅ 13 x 96 mm [MA-36] PA
	37–39	Currently not used
	40	M10 x 1 x 40 mm [MA-40] PPE
	41	50 x 31 x 11 mm [MA-41] PA
	42	88 x 25 x 13 mm [MA-42] PA
	43	PG9 x 80 mm [MA-43] Ms
	44	80 x 30 x 15 mm [MA-44] PA
	45	45 x 25.5 x 9 mm [MA-45] PA
	46	∅ 6.5 x 39.34 mm [MA-46] PA
	47	Currently not used
	48	80 x 30 x 15 mm [MA-48] PA
	49–51	Currently not used
	52	43 x 26 x 13 mm [MA-52] PBT
	53	M30 x 1.5 mm [MA-53] PA
	54	Currently not used
	55	12 x 12 x 55 mm [MA-55] S
	56–59	Currently not used
	60	M8 x 1 mm [MA-60] S
	61	M10 x 1 mm [MA-61] S
	62	M12 x 1 mm [MA-62] S
	63	M18 x 1 mm [MA-63] S
	64	M30 x 1.5 mm [MA-64] S
	65–69	Currently not used
	70	∅ 6.5 mm [MA-70] S
	71/72	Currently not used
	73	68 x 30 x 15 mm [MA-73] S
	74–79	Currently not used
	80	8 x 8 x 40 mm [MA-80] S
	81–98	Currently not used
	99	other [MA-99] S

## Magnetic Switch Monitoring Devices

1	2	3	4	5	6	7	8	9	10	11	12	13	14	15	16	17	18	19	20	21	22	23	24
M	Ü	Z	-	1	0	2	/	U	2	4	-	F	L	-	2	S	-	E	2	0	-	H	G
Product group			Numb. of magnetic switches	Number of relays			Voltage			Special features													

Product group		
1	M	Magnetic limit switch, general
2	Ü	Monitoring
	C	Controller
3	Z	Control station
	S	Interface
	N	Power supply unit
4	-	Dash (fixed)
Number of connectable magnetic switches		
5	1	1 unit
	2	2 units
	...	etc.
Number of relays		
6 – 7	01	1 unit
	02	2 units
	03	Constant current source
	04	4 units
	...	etc.
8	/	Slash (fixed)

Voltage		
9	A	AC
	D	DC
	U	UC
	1	Mains voltage
	2	Mains voltage
10 – 11	24	24 Volt
	The following applies when there is a "1" in the 9 <sup>th</sup> position:	
	10	110 Volt
	20	120 Volt
	30	130 Volt
	The following applies when there is a "2" in the 9 <sup>th</sup> position:	
	10	210 Volt
	20	220 Volt
	30	230 Volt

Special features		
13 – 24	FL	Flat design
	2S	NO contact signal (to outside)
	E20	20 transducer units, externally
	HG	Hall sensor
	VC	Voltage control
	PRT	Print version
	DA	Data output
	Special features are separated by a dash with no specific position assignment.	



## Magnetic Sensors / Teachable Slot Sensors / Electronic

1	2	3	4	5	6	7	8	9	10	11	12	13	14	15						
<b>M</b>	<b>E</b>	<b>K</b>	<b>-</b>	<b>M</b>	<b>1</b>	<b>2</b>	<b>P</b>	<b>S</b>	<b>/</b>	<b>H</b>	<b>1</b>	<b>0</b>	<b>-</b>	<b>K</b>	<b>L</b>	<b>2</b>				
Product group			Type of enclosure				Output		Sensitivity				Options							

Product group		
1	M	Magnetic sensor
2	E	Electronic
3	K	Plastic
	M	Brass
	N	Stainless steel
4	-	Dash (fixed)
Type of enclosure		
5	M	Metric thread
	D	Round enclosure
	E	Rectangular enclosure
	Q	Cuboid enclosure
6 – 7		Two-digit number for:
		Metric enclosure = standard designation
		Round enclosure = Ø as specified
		Rectangular enclosure = enclosure width
		Cuboid enclosure = edge length

Output		
8	P	PNP
	N	NPN
9	S	NO contact
	Ö	NC contact
	B	Bistable
	A	Analogue
	D	Speed
10	/	Slash (fixed)
Sensitivity		
11	H	Hall
	M	Magnetoiresistive
12 – 13		Sensitivity in mT
	z. B. 10	10 mT
	z. B. 01	1 mT
14	-	Dash (fixed)
Options		
15		See type code "OPTIONS", see page 106

## Type Code

### Options

1	2	3	4	5	6	7	8	9	10	11	12	13	14				
<b>K</b>	<b>L</b>	<b>2</b>	<b>E</b>	<b>V</b>	<b>P</b>	<b>S</b>	<b>N</b>	<b>T</b>	<b>F</b>	<b>Z</b>	<b>I</b>	<b>D</b>	<b>G</b>				

1	K	Short circuit-proof
2	L	LED
3	2	Cable length in m
4	E	Extended sensing distance (sn large)
5	V	Shortened type
6	P	Potentiometer
7	S	Device connector (terminals)
	PU	PUR cable
	SD	Connector to DIN 43650 (including socket)
	SM	Mini snap-in device connector
	S8	M8 device connector with union nut
	S12	M12 device connector with union nut
	SM8	Mini snap-in / M8 screw-on device connector
	S12A	M12 device connector with union nut, AC version
	S16S	M16 device connector with union nut and dust cap
	S12U	M12 Ultra-Lock device connector
	S5	M5 x 0,5 device connector Screw-connection with cable

8	N	Stainless steel enclosure
9	T	Extended temperature range
10	F	Extended switching frequency
11	Z	Time-delayed
12	I	Programmable (intelligent)
13	D	ATEX products, dust Ex
14	G	ATEX products, gas Ex

## Cable Connectors

1	2	3	4	5	6	7	8	9	10	11	12	13	14	15	16	17			
<b>W</b>	<b>D</b>	<b>K</b>	<b>-</b>	<b>M</b>	<b>1</b>	<b>2</b>	<b>P</b>	<b>S</b>	<b>/</b>	<b>L</b>	<b>L</b>	<b>2</b>	<b>-</b>	<b>2</b>	<b>P</b>	<b>U</b>			
Device specifications			Type of connection				Classification			LEDs			Cable length	Options					

Device specifications		
1		Cable output
	W	Elbow
	G	Straight
2		Product group
	D	Socket
	S	Connector (the sensor connections should always be used as the basis for connecting lines with different outputs)
	A	Adapter (socket and connector)
3		Preassembly
	K	Fixed cable
	A	Connection space, self-configurable
	V	Connecting line (extension)
4	-	Dash (fixed)
Type of connection		
5 - 7		Always related to the socket / connector
	M12	Union nut M12 x 1
	M08	Union nut M8 x 1
	R06	Round snap-in connection Ø 6.5 mm
	R12	Round snap-in connection, Ultra-Lock M12
	M05	M5 x 0.5 screw-on connection

Classification		
8		Configuration for switch output
	P	PNP (LED to negative)
	N	N = NPN (LED to positive)
	U	Universal (no LED)
	A	AC (M12 special coding Pin 1 + 2)
9		Pin assignments of cable sockets for switch output
	S	NO contact 1 - 3 - 4 for M12 1 - 3 - 2 for Mini 1 - 2 for M12 AC
	Ö	NC contact 1 - 3 - 2 for M12
	A	Antivalent 1 - 3 - 4 - 2 for M12
	N	NAMUR 1 - 3 for M12
	U	More than 4 connections
	T	Teach-in function
10	/	Slash (fixed)
Manufacturer		
11		Internal information

LEDs		
12	L	Integrated LED
	O	Without LED
13		Number of LEDs
	0	No LED
	1	1 LED
	2	2 LEDs etc.
14	-	Dash (fixed)
Cable length		
15		In m (moulded cable)
Options		
16 - 17	PU	Polyurethane cable
	HF	Highly flexible cable
	SD	Connector/socket
	BD	Socket both ends
	R	Vibration safeguard
	Without	PVC cable

# Type Code

## Mounting Material

1	2	3	4	5	6	7	8	9											
<b>B</b>	<b>K</b>	<b>S</b>	<b>-</b>	<b>D</b>	<b>2</b>	<b>0</b>	<b>P</b>	<b>A</b>											
Product group				Type group			Material												

Product group		
1	B	Mounting material
2		Type of product
	K	Retaining bracket
	W	Mounting bracket
	H	Retaining plate
3		Specification
	S	Bracket, 2-piece
	B	Block, 1-piece
	R	Reducer
	N	90° elbow
4	-	Dash (fixed)

Type group		
5-7		<b>For clips:</b>
		Diameter in mm corresponding to matching sensor
		<b>For elbows:</b> Type group
	e.g. L05	Light barrier OR05
	e.g. M06	Magnetic switch M06
Material		
8-9		Material
	ST	Steel
	NI	Stainless steel
	AL	Aluminium
	PA	Polyamide
	PP	Polypropylene

## Types of Output DC 1

Cable colour abbreviations

BN = Brown

BU = Blue

BK = Black (switch output)

### PNP output (circuit schematic)

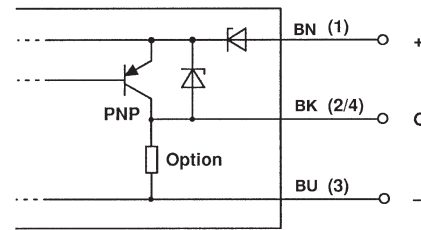

### NPN output (circuit schematic)

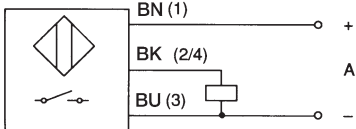
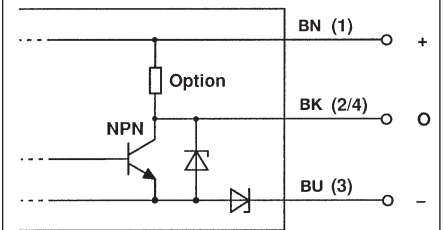

#### 1) PNP normally-open contact

When actuated, a PNP transistor applies the output to positive.

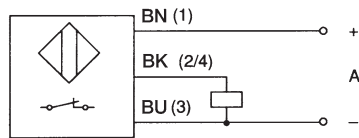

#### 2) PNP normally-closed contact

When actuated, a PNP transistor disconnects the output from positive.

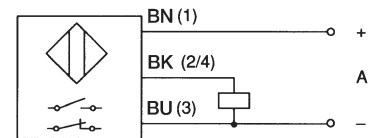

#### 3) PNP programmable

The PNP NO contact 1) or PNP NC contact 2) function can be selected by means of a built-in changeover switch.

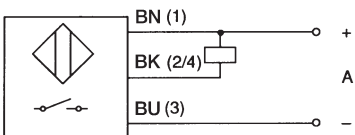

#### 4) NPN normally-open contact

When actuated, a NPN transistor applies the output to negative.

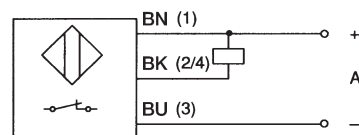

#### 5) NPN normally-closed contact

When actuated, an NPN transistor disconnects the output from negative.

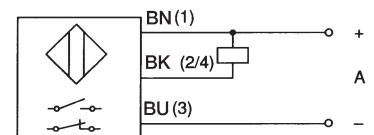

#### 6) NPN programmable

The NPN NO contact 4) or NPN NC contact 5) function can be selected by means of a built-in changeover switch.

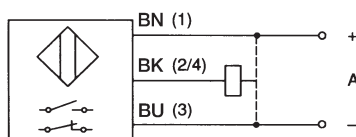

#### 7) PNP/NPN programmable

Two built-in changeover switches are used to select between PNP or NPN switching and between NC or NO function.

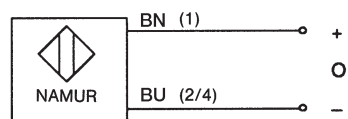

#### 8) NAMUR

Current change to DIN EN 60947-5-6

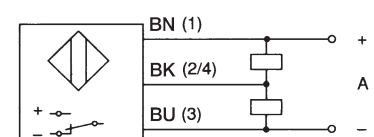

#### 9) Push-pull programmable

When actuated, the output changes from negative to positive or, selectable with a built-in changeover switch, from positive to negative.

# Wiring Diagrams

## Types of Output DC 2

Cable colour abbreviations

- BN = Brown
- BU = Blue
- BK = Black (switch output)
- WH = White (switch output)

**DC 2-wire**  
(circuit schematic)

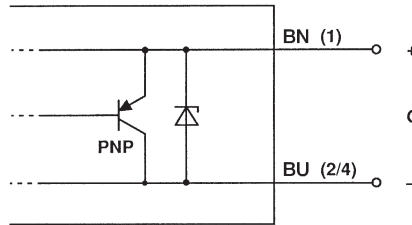

**DC 4-wire**  
(circuit schematic)

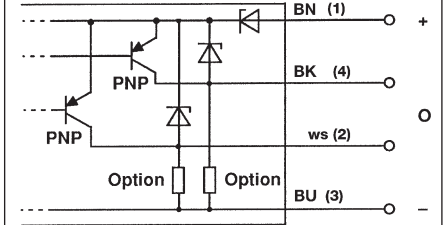

**1) NO contact DC 2-wire**  
When actuated, the contacts are bridged.

**2) NC contact DC 2-wire**  
When actuated, the contacts are disconnected.

**3) NC/NO contact programmable DC 2-wire**  
The NO contact 1) or NC contact 2) function can be selected by means of a built-in changeover switch.

**4) Changeover output DC (antivalent) PNP 4-wire**  
When actuated, the positive operating voltage is alternatively applied to one of the two outputs.

**5) Changeover output DC (antivalent) NPN 4-wire**  
When actuated, the negative operating voltage is alternatively applied to one of the two outputs.

## Types of Output AC 1

Cable colour abbreviations

BN = Brown  
 BU = Blue  
 BK = Black

**AC 2-wire**  
 (circuit schematic)

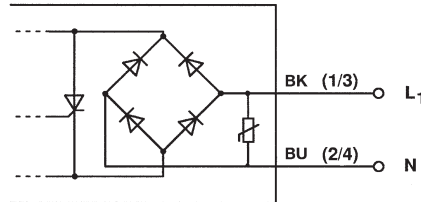

**AC 3-wire**  
 (circuit schematic)

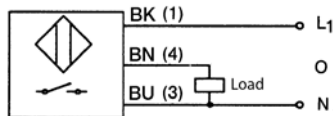
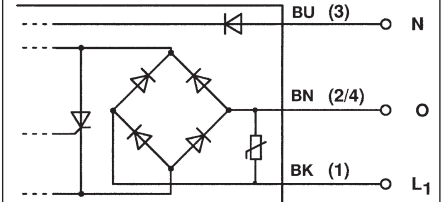

**1) NO contact AC 3-wire**

When actuated, a thyristor connected across a rectifier bridge applies the operating voltage to the output.

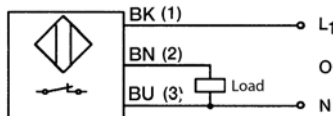

**2) NC contact AC 3-wire**

When actuated, a thyristor connected across a rectifier bridge disconnects the operating voltage from the output.

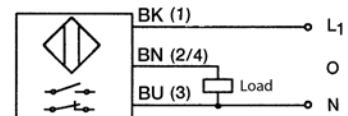

**3) NC/NO contact programmable AC 3-wire**

The AC NO contact 1) or AC NC contact 2) function can be selected by means of a built-in changeover switch.

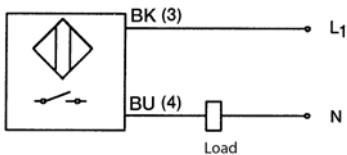

**4) NO contact AC 2-wire**

When actuated, a thyristor connected across a rectifier bridge applies the load to the operating voltage.

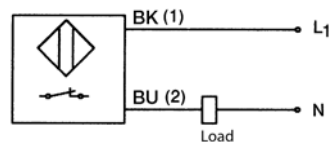

**5) NC contact AC 2-wire**

When actuated, a thyristor connected across a rectifier bridge disconnects the load from the operating voltage.

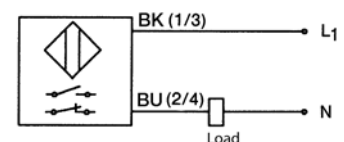

**6) NC/NO contact programmable AC 2-wire**

The AC NO contact 4) or AC NC contact 5) function can be selected by means of a built-in changeover switch.

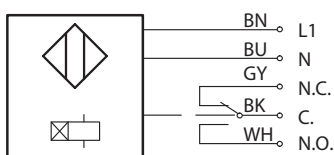

**7) AC relay output**

With adjustable pickup delay

# Wiring Diagrams







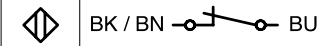

## Type of Contact

### Electric Loading Capacity of Reed Contacts AC/DC

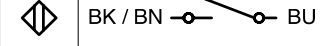
Contact type ID	Power	Voltage	Current
R	3 VA	28 V	0.25 A
X	5 VA	100 V	0.25 A
B	10 VA	250 V	0.5 A
Y	10 VA	100 V	0.5 A
A	20 VA	250 V	0.5 A
K	30 VA	250 V	0.5 A
H	60 VA	250 V	1.0 A
L	60 VA	250 V	1.0 A
M	80 VA	250 V	1.0 A
F	100 VA	250 V	3.0 A
G	250 VA*	250 V	5.0 A*
P	250 VA*	250 V	5.0 A*

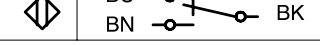
\* Maximum make current for the duration of 2 ms  
2.5 A; 100 W/VA in continuous operation

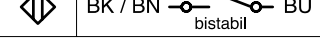
## Wiring Diagrams Electromechanical Magnetic Switches

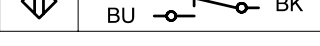
contact		
NO contact		
Changeover contact		
Bistable ON-OFF		
Bistable Changeover contact		

## Wiring Diagrams Electronic Magnetic Switches

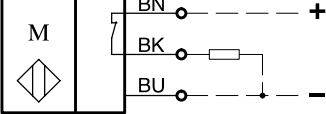
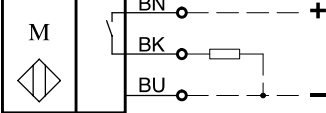
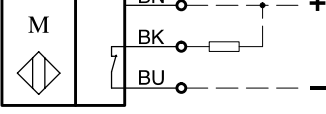
NC contact, PNP	
NO contact, PNP/PNP, bistable	
NC contact, NPN	
NO contact, NPN	