

Anschlußschema

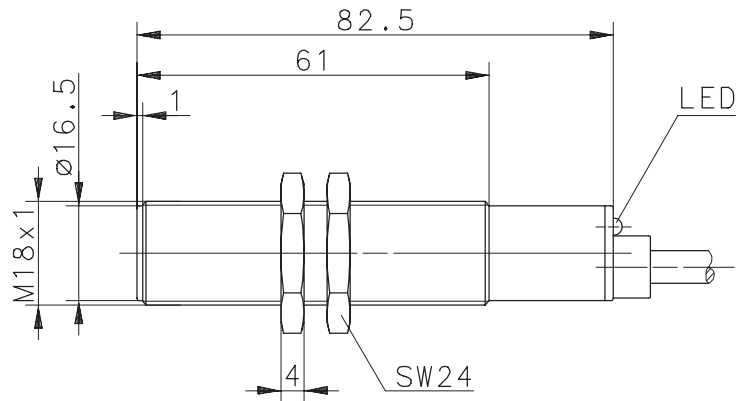
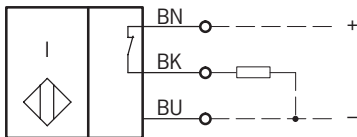

Kenndaten nach EN 60947-5-2

Elektrische Daten

Bemessungsbetriebsspannungsbereich	U_B	10 - 60V DC
Bemessungsisolationsspannung	U_i	75V DC
Bemessungsstoßspannungsfestigkeit	U_{imp}	500V
Spannungsfall	U_d	$\leq 2,5V$
Gebrauchskategorie		DC-13 bei $I_e = 50mA$ und $U_e = 33V$ DC
Bemessungsbetriebsstrom	I_e	$\leq 200mA$
Reststrom	I_r	$< 0,1mA$
Leerlaufstrom	I_0	$< 8mA$
Schutzart		IP 67
Art des Kurzschlußschutzes		taktend
Bemessungsschaltabstand	s_n	5mm
gesicherter Schaltabstand	s_a	0 ... 4,1mm
Wiederholgenauigkeit	R	$\leq 5\%$
Hysterese	H	$\approx 10\%$
Schaltfrequenz	f	500Hz
Schaltelementfunktion		DC, Öffner
Einbauart		bündig
Verpolschutz		ja
Ausgang		dauerkurzschluß- und überlastfest
Bereitschaftsverzug	t_v	$\leq 50ms$

Elektromagnetische Verträglichkeit (EMV)

Hochfrequenzbeeinflussungsfestigkeit	IEC 61000-4-3
Elektrostatische Entladungsfestigkeit	IEC 61000-4-2
Transientenfestigkeit	IEC 61000-4-4
Störaussendung	EN55011
Stoßspannungsfestigkeit	IEC 255-5

Mechanische Daten

Umgebungstemperatur	-25°C bis +70°C
Frontkappe	PA 6.6, schwarz
Gehäuse	Messing, vernickelt
Funktionsanzeige	LED, gelb
Anschlußart	Kabel 3 x 0,5mm ² x 6m, PVC-Mantel, schwarz
Befestigungshilfen	2 x Sechskantmutter

Technical Data Inductive Proximity Switch

Type: **KIB-M18PÖ/005-KL6**

Part.-No.: **650.2705.009**

Wiring Diagram

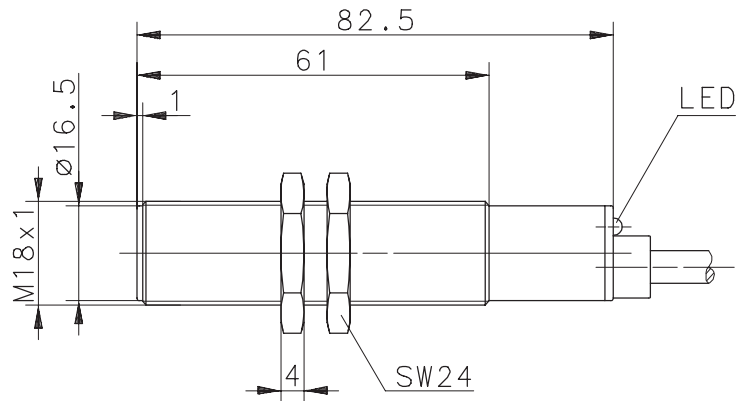
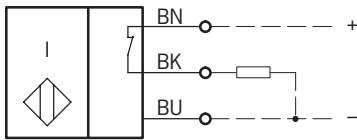

Technical Data according to EN 60947-5-2

Electrical Data

Operational voltage range	U_B	10 - 60VDC
Rated insulation voltage	U_i	75VDC
Rated impulse withstand voltage	U_{imp}	500V
Voltage drop	U_d	$\leq 2,5V$
Utilization category		DC-13 @ $I_e = 50mA$ and $U_e = 33V$ DC
Rated operational current	I_e	$\leq 200mA$
Off-state current	I_r	$< 0,1mA$
No-load supply current	I_0	$< 8mA$
Type of protection		IP 67
Short-circuit protection		pulsed
Rated operating distance	s_n	5mm
Assured operating distance	s_a	0 ... 4,1mm
Repeat accuracy	R	$\leq 5\%$
Differential travel (hysteresis)	H	$\approx 10\%$
Frequency of operating cycles	f	500Hz
Switching function		DC, N.C.
Mounting		flush
False polarity protection		yes
Output		permanent overload and s.c.p.
Time delay before availability	t_v	$\leq 50ms$

Elektromagnetic compatibility (EMC)

Electromagnetic field test	IEC 61000-4-3
Electrostatic discharge test	IEC 61000-4-2
Electrical fast transient immunity test	IEC 61000-4-4
Radiated disturbance field strength	EN55011
Impulse voltage withstandability	IEC 255-5

Mechanical Data

Operating temperature	-25°C bis +70°C
Front cap	PA 6.6, black
Housing	brass, nickel plated
Indication	LED, yellow
Termination type	Cable 3 x 0,5mm ² x 6m; PVC - Outer jacket, black
For attachment	2 x hexagon nut