



BNC / BNC 75 HDTV / BNC-TRX

R141 / R142 / R266



Contents

BNC

Introduction 9-4 to 9-5
Interfaces 9-6 to 9-7
Characteristics 9-8 to 9-11
Panel drilling 9-31 to 9-32

COMPOSITE BNC 75 HDTV

Plugs 9-12

BNC 75 HDTV

Plugs 9-13
Jacks 9-14
Receptacles 9-14
Adapters 9-15

BNC 50Ω

Plugs 9-16 to 9-17
Jacks 9-18 to 9-19
Receptacles 9-20 to 9-22
Adapters 9-23 to 9-24
Caps 9-24

BNC 75Ω

Plugs 9-25 to 9-26
Jacks 9-26 to 9-27
Receptacles 9-28
Adapters 9-29

BNC-TRX

Characteristics 9-30
Plugs 9-30
Jacks 9-30
Receptacles 9-30

Introduction



50Ω	DC - 4 GHz
	DC - 1.5 GHz (commercial)
	DC - 1.0 GHz (Eco)
	DC - 10 GHz (TRIAxIAL)
75Ω	DC - 1.5 GHz
	DC - 6 GHz (HDTV)
	DC - 1.0 GHz (Eco)

GENERAL

- Worldwide standardized coaxial connectors
- Bayonet coupling
- Proven strength and reliability
- Good RF performance

APPLICABLE STANDARDS

- MIL-C-39012 / MIL STD 348-A/301
- IEC 169-8
- CECC 22120
- NF-C-93564 KBN series
- UTE-C-93564

APPLICATIONS

- Civil and military radio-telecommunication equipment
- Test and measurement
- Video communication
- Broadcast
- Industrial network
- General electronics

The BNC connector is the most popular coaxial connector series in the world, featuring a two-pin bayonet coupling system for quick and reliable engagement and disengagement.

• Wide range:

Radiall's BNC connectors are available with two characteristic impedances: 50Ω and 75Ω. They are completely intermateable. RADIALL also offers low-cost BNC range, and a triaxial BNC TRX series.

• Convenient three piece design:

Straight and right angle crimp type cable connectors feature a three piece design: single piece body + center contact + outer ferrule.



Introduction

• Fast and reliable cable attachment

Cable connectors can be either fully crimped or soldered/crimped, offering full flexibility for fast, reliable, high-volume production with standard manual or pneumatic tooling.

- The center contact can be either crimped or soldered,
- The outer contact is attached to the cable by crimping a ferrule.

COMPOSITE BNC 75Ω HDTV CONNECTOR

GENERAL

- The first lightweight composite HDTV BNC available on the market
- Easy to connect and disconnect from the rear—ideal for high-density and recessed bulkhead applications
- Color-coded boots directly on the connector for easy video signal identification
- Guaranteed frequency up to 6 GHz for studio-quality performance
- 1000 mating cycles minimum for guaranteed durability in the field
- True 75Ω design

HDTV places new demands on maintaining high signal integrity at high data rates, from studio-quality broadcast production to video conferencing equipment, our selection of affordable HDTV BNC connectors offer more bandwidth, more performance, and are easier to use.

Our new technologically advanced high-speed composite BNC 75Ω HDTV connector features an incredible easy-to-use two-piece design that makes it easy to crimp on the cable. This new connector can handle data rates up to 3 Gbps or higher while meeting or exceeding SMPTE 292M and 424M standards. The gold plated center and outer contacts provide outstanding electrical performance with a frequency range of up to 6 GHz, and a low return loss of -32 dB at 3 GHz.

The connector comes in a wide variety of colors for signal cable identification and its special curved interface composite material design with positioning marks makes it easy and fast to connect in high-density and recessed bulkhead applications.

APPLICATIONS

- Broadcast TV stations and studios
- Video routing and production
- Video surveillance equipment
- Video conference equipment



BNC 75 HDTV/BNC 50Ω

Interface BNC 75 HDTV

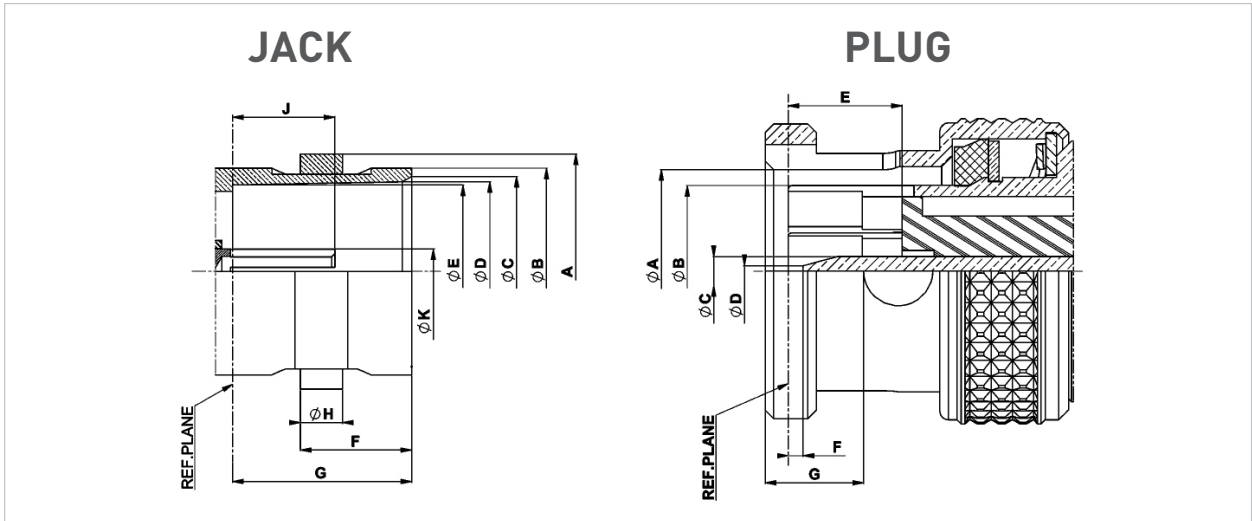

Letter	mm		inch	
	min.	max.	min.	max.
A	10.97	11.07	.432	.436
B	9.60	9.67	.378	.381
C	8.80	9.00	.346	.354
D	8.32	8.46	.328	.333
E	8.10	8.15	.319	.321
F	5.18	5.28	.204	.208
G	8.30	8.50	.327	.335
H	1.90	2.06	.075	.081
J	4.72	5.22	.186	.206
K	2.10	2.14	.083	.084

Letter	mm		inch	
	min.	max.	min.	max.
A	9.80	9.90	.386	.390
B	8.30	8.40	.327	.331
C	1.32	1.37	.052	.054
D	0.35	0.65	.014	.026
E	5.30	5.50	.209	.217
F	0.10	0.90	.004	.035
G	4.57	4.67	.180	.184

Interface BNC 50Ω

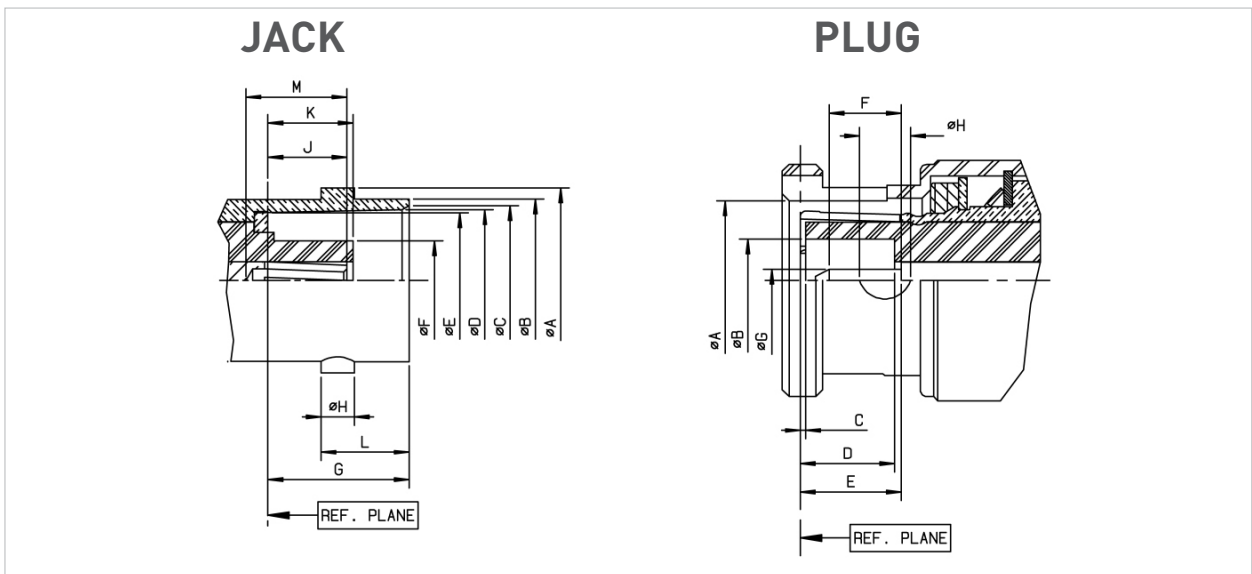

Interface BNC 50Ω

Letter	mm		inch	
	min.	max.	min.	max.
A DIA	10.97	11.07	.432	.436
B DIA	9.60	9.70	.378	.382
C DIA	8.79	9.04	.346	.356
D DIA	8.31	8.46	.327	.333
E DIA	8.10	8.15	.319	.321
F DIA	-	4.72	-	.186
G	8.31	8.51	.327	.335
H	1.91	2.06	.075	.081
J	4.72	5.23	.186	.206
K	4.78	5.28	.188	.208
L	5.18	5.28	.204	.208
M	4.95	-	.195	-

Letter	mm		inch	
	min.	max.	min.	max.
A DIA	9.78	9.91	.385	.390
B DIA	4.83	-	.190	-
C	0.15	-	.006	-
D	5.28	5.79	.208	.228
E	5.33	5.84	.210	.230
F	1.98	-	.078	-
G DIA	1.32	1.37	.052	.054
H DIA	2.31	2.46	.091	.097

Interface BNC 75Ω

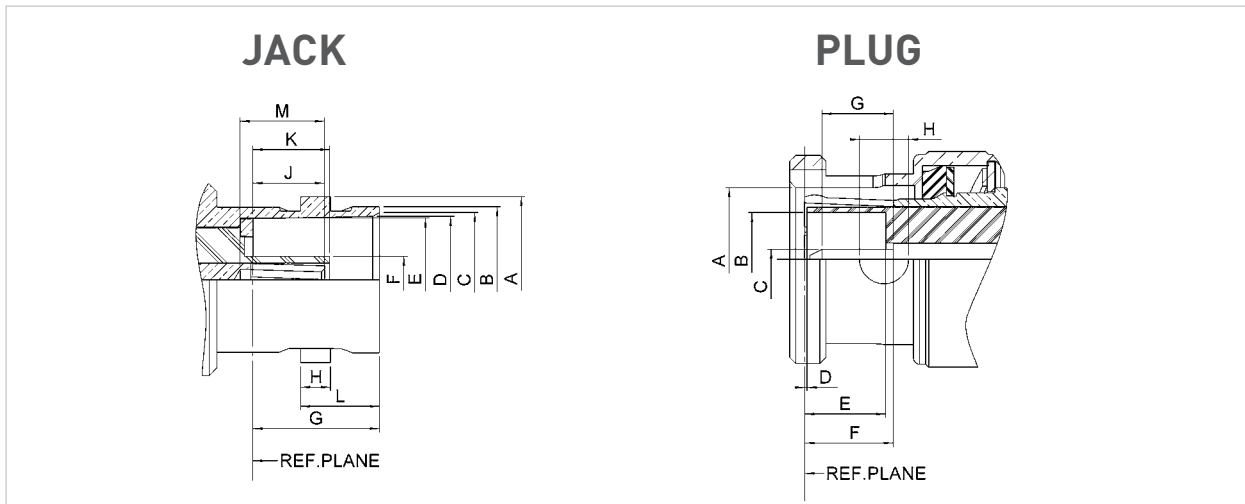

Letter	mm		inch	
	min.	max.	min.	max.
A DIA	10.97	11.07	.432	.436
B DIA	9.60	9.67	.378	.381
C DIA	8.80	9.00	.347	.354
D DIA	8.32	8.46	.328	.333
E DIA	8.10	8.15	.319	.321
F DIA	4.62	4.72	.182	.186
G	8.30	8.50	.326	.334
H	1.90	2.06	.074	.081
J	4.72	5.22	.186	.205
K	4.98	5.23	.196	.206
L	5.18	5.28	.204	.208
M	5.30	5.90	.209	.232

Letter	mm		inch	
	min.	max.	min.	max.
A DIA	9.80	9.90	.386	.389
B DIA	6.10	6.30	.240	.248
C DIA	1.32	1.37	.052	.054
D	0.05	-	.002	-
E	5.42	5.78	.213	.227
F	5.35	5.87	.211	.231
G	3.00	3.40	.118	.134
H DIA	3.15	3.35	.124	.132

Characteristics

ELECTRICAL CHARACTERISTICS

Frequency range	DC - 6 GHz (optimized at 3 GHz)		
Impedance	75Ω		
V.S.W.R. (max)	DC - 1.5 GHz	1.5 - 3 GHz	3 - 6 GHz
• Interface (plug + jack)	1.02	1.05	1.08
• Mated pair	1.05	1.12	1.25
• In series adapters	1.04	1.07	1.12
Working voltage	500 Vrms		
Dielectric withstanding voltage	1500 Vrms		
RF Leakage @ 1 GHz	75 dB		
RF Leakage @ 3 GHz	60 dB		
RF Leakage @ 6 GHz	50 dB		

MECHANICAL CHARACTERISTICS

Mating	Intermateable with 50Ω and 75Ω standard BNC connectors
Long life duration (mating endurance)	1000 cycles
Engagement force	13.6 N
Mating torque (bayonet)	28.6 N.cm
Coupling nut retention force	Axial force: 450 N Bending stress: 1000 N.cm
Center contact insertion force	10 N max
Vibration	MIL STD 202 Meth.204 cond B

ENVIRONMENTAL CHARACTERISTICS

Temperature range	-65°C + 165°C
Moisture resistance	MIL STD 202, Meth. 106 CECC 22000 paragraph 4.6.6
Corrosion resistance	MIL STD 202, Meth. 101 cond B (48 hours salt spray)

MATERIALS AND PLATING

Components	Materials	Platings
Body	Brass	NPGR/BBR/Nickel
Center contact	Brass or Beryllium copper	NPGR
Outer contact	Brass	NPGR
Insulator	PTFE	
Gasket	Silicone Rubber	

Composite version

CHARACTERISTICS

Frequency range	DC up to 6GHz
Impedance	75 Ω
VSWR	1.05 @ 3GHz (Return loss -32dB)
Mating Cycles	1000
Temperature Range	-40 °C ~ + 85 °C

MATERIAL AND PLATING

Parts	Materials	Plating
Coupling Nut	Composite	
Body	Brass	Gold
Outer contact	Brass	Gold
Center Contact	Brass	Gold
Insulator	PTFE	

Characteristics

Test / Characteristics	Standard reference	Values / Remarks
------------------------	--------------------	------------------

ELECTRICAL CHARACTERISTICS

Test / Characteristics	Standard reference	Values / Remarks												
Impedance		50Ω												
Frequency range		DC - 4 GHz												
Typical V.S.W.R. • Straight models cable groupe: 2/50, 2.6/50, 5/50, 10 + 11/50, .141" • Right angle models: 2/50, 2.6/50, 5/50		<table border="1"> <tr> <td>1 GHz</td> <td>2.5 GHz</td> <td>4 GHz</td> </tr> <tr> <td>1.12</td> <td>1.18</td> <td>1.22</td> </tr> <tr> <td></td> <td>1.30 max</td> <td></td> </tr> <tr> <td>1.13</td> <td>1.20</td> <td>1.22</td> </tr> </table>	1 GHz	2.5 GHz	4 GHz	1.12	1.18	1.22		1.30 max		1.13	1.20	1.22
1 GHz	2.5 GHz	4 GHz												
1.12	1.18	1.22												
	1.30 max													
1.13	1.20	1.22												
Insertion loss • Straight connector • Right-angle connector		<table border="1"> <tr> <td>0.05</td> <td>0.07</td> <td>0.13</td> </tr> <tr> <td>0.08</td> <td>0.16</td> <td>0.20</td> </tr> </table>	0.05	0.07	0.13	0.08	0.16	0.20						
0.05	0.07	0.13												
0.08	0.16	0.20												
RF leakage		-55 dB min from 2 to 3 GHz												
Insulation resistance		5000 MΩ min												
Contact resistance • Center contact • Outer contact	MIL	1.5 mΩ 0.2 mΩ												
Working voltage in VRMS • At sea level (at 21 000m)		500 125												
Dielectric withstanding voltage in VRMS • At sea level (at 21 000m)		1500 375												
RF testing voltage in VRMS Sea level (5 MHz)		1000												

MECHANICAL CHARACTERISTICS

Test / Characteristics	Standard reference	Values / Remarks
Durability		500 matings
Force to engage and disengage • Axial • Torque		13.6 N max 28.6 Ncm
Coupling nut retention force		445 N
Cable retention force • Cable 2/50, 2.6/50 • Cable 5/50, 10 + 11/50 • Cable .141"	MIL	227 N
Center contact retention force		27.2 N

ENVIRONMENTAL CHARACTERISTICS

Test / Characteristics	Standard reference	Values / Remarks
Temperature range • Flexible cables • Semi-rigid cables		-65°C + 165°C -65°C + 105°C
Thermo cycling test		MIL STD 202, method 107, condition B
Thermal shock		MIL STD 202, method 107, condition B
High temperature endurance		MIL STD 202, method 108
Corrosion salt spray		MIL STD 202, method 101, condition B
Vibration		MIL STD 202, method 204, condition B
Shock		MIL STD 202, method 213, condition G
Moisture resistance		MIL STD 202, method 106
Hermetic test		MIL STD 202, method 112, condition C vacuum 10 ⁻⁶ Hgmm (Torr) leakage rate < 10 ⁻⁶ atm/cm ³ /s
Barometric pressure		Pressure test: 3.5 bars; duration: 2 mn; temperature: 15°C to 25°C

MATERIALS AND PLATING

	Materials	Platings
Bodies	Brass	Nickel / BBR
Center contact • Male • Female	Brass Bronze or heat treated beryllium following QQ-C-530	Gold
Nut	Brass	
Insulator	PTFE	
Gasket	Silicon Rubber	

All dimensions are given in mm.

Go online for data sheets & assembly instructions.



Visit www.radiall.com and enter the part number.

Characteristics

Test / Characteristics	Standard reference	Values / Remarks
------------------------	--------------------	------------------

ELECTRICAL CHARACTERISTICS

Impedance		75Ω
Frequency range		DC - 1.5 GHz
V.S.W.R. max		1.30
<ul style="list-style-type: none"> Straight models cable group: 2.6/75, 5/75, 6/75, 8/75, 10 + 11/75 Right angle models: 2.6/75, 6/75 		1.35
Insertion loss		0.2 dB max at 1 GHz 0.3 dB max at 1 GHz
<ul style="list-style-type: none"> Straight connector Right-angle connector 		
RF leakage		-55 dB min from 2 to 3 GHz
Insulation resistance		5000 MΩ min
Contact resistance	MIL	1.5 mΩ 0.2 mΩ
<ul style="list-style-type: none"> Center contact Outer contact 		
Working voltage in VRMS		500 125
<ul style="list-style-type: none"> At sea level (at 21 000m) 		
Dielectric withstanding voltage in VRMS		1500 375
<ul style="list-style-type: none"> At sea level (at 21 000m) 		
RF testing voltage in VRMS	Sea level (5 MHz)	1000

MECHANICAL CHARACTERISTICS

Durability		500 matings
Force to engage and disengage		13.6 N max 28.6 Ncm
<ul style="list-style-type: none"> Axial Torque 	MIL	
Coupling nut retention force		445 N
Cable retention force	Cable 2.6/75, 5/75 6/75, 8/75, 10 + 11/75	340 N
Center contact retention force		27 N

ENVIRONMENTAL CHARACTERISTICS

Temperature range	flexible cables		-65°C + 165°C
Thermo cycling test			MIL STD 202, method 107, condition B
High temperature endurance			MIL STD 202, method 108
Corrosion salt spray			MIL STD 202, method 101, condition B
Vibration			MIL STD 202, method 204, condition B
Shock			MIL STD 202, method 213, condition G
Moisture resistance			MIL STD 202, method 106
Barometric pressure			Pressure test: 3.5 bars; duration: 2 mn; temperature: 15°C to 25°C

MATERIALS AND PLATING

	Materials	Platings
Bodies	Brass	Nickel
Center contact	Brass Bronze or heat treated beryllium following QQ-C-530	Gold
<ul style="list-style-type: none"> Male Female 		
Nut	Brass	
Insulator	PTFE	
Gasket	Silicone Rubber	

Standard packaging = 100 pieces

Go online for data sheets & assembly instructions.



Visit www.radiall.com and enter the part number.

Characteristics

Commercial version R141 XXX 161 and R142 XXX161

ELECTRICAL CHARACTERISTICS

	R141 XXX 161	R142 XXX 161
Impedance	50Ω	75Ω
Operating frequency	DC to 1.5 GHz	
Typical V.S.W.R. (1.5 GHz)		
• Straight models	∅ 2.6	1.21
	∅ 5	1.14
	∅ 6	1.05
• Right angle models	∅ 5 & ∅ 6	1.17
Testing voltage (VRMS)	1500	
Operating voltage (VRMS)	500	
Insulation resistance (MΩ)	5000	
Contact resistance (mΩ)	10	

MECHANICAL CHARACTERISTICS

Durability	100 matings
------------	-------------

ENVIRONMENTAL CHARACTERISTICS

Temperature range	-40°C + 85°C
-------------------	--------------

MATERIALS AND PLATING

	Materials	Platings
Male and female bodies	Brass	Nickel
Coupling nut	Die cast zinc	
Outer contact	Brass	
Insulators	Polypropylene	
Male and female center contacts	Brass	Gold

ECO version R141A XXX XXX and R142A XXX XXX

ELECTRICAL CHARACTERISTICS

	R141A XXX XXX	R142A XXX XXX
Impedance	50Ω	75Ω
Frequency range	DC - 1 GHz	
Typical V.S.W.R. (straight models)	1.3 at 1 GHz	
Temperature range	-40°C / +85°C	
Durability	100 mating cycles	

MATERIALS AND PLATING

	Materials	Platings
Connector body	Brass/Die cast zinc	Nickel
Insulators	PTFE/Polypropylene	
Female center contacts	Phosphor bronze	Gold 0.1µm typical (Center contact)

PACKAGING

Packaging	100 pieces bulk Unit packaging
-----------	-----------------------------------

Standard packaging = 100 pieces

All dimensions are given in mm.

Plugs

STRAIGHT PLUGS CRIMP TYPE FOR FLEXIBLE CABLES

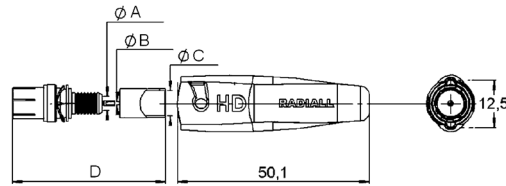

Cable group	Cable group dia.	Part number	Color	Dimensions			
				A	B	C	D
Mini RG59 Belden 1855A, DRAKA 0.6/2.8 CAE HD 0628	0.6/2.8	R142 079 750	Black	2.85	0.65	5.42	26.7
		R142 079 751	Red				
		R142 079 752	Green				
		R142 079 753	Blue				
		R142 079 754	Yellow				
		R142 079 755	Grey				
		R142 079 756	White				
		R142 079 757	Brown				
		R142 079 758	Orange				
		R142 079 759	Violet				
RG59 BELDEN 1505A DRAKA 0.8/3.7 ARGOSY Image 720 CAE HD 08370	0.8/3.7	R142 079 760	Black	3.75	0.85	6.6	25.7
		R142 079 761	Red				
		R142 079 762	Green				
		R142 079 763	Blue				
		R142 079 764	Yellow				
		R142 079 765	Grey				
		R142 079 766	White				
		R142 079 767	Brown				
		R142 079 768	Orange				
		R142 079 769	Violet				
RG6 BELDEN 1694A DRAKA 1.0/4.8 ARGOSY Image 1000 CAE 10460	1.0/4.8	R142 079 770	Black	4.85	1.05	7.1	23.7
		R142 079 771	Red				
		R142 079 772	Green				
		R142 079 773	Blue				
		R142 079 774	Yellow				
		R142 079 775	Grey				
		R142 079 776	White				
		R142 079 777	Brown				
		R142 079 778	Orange				
		R142 079 779	Violet				

Plugs

STRAIGHT PLUGS CRIMP TYPE FOR FLEXIBLE CABLES

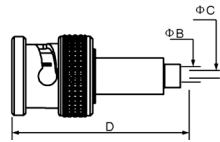

Fig. 1

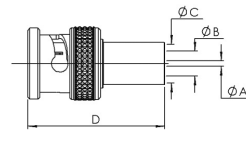
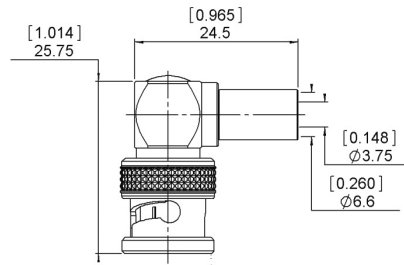

Fig. 2

Cable group	Cable group dia.	Part number	Fig.	Dimensions mm (inch)				Packaging	Note	
				A	B	C	D			
RD179 BELDEN179DT, DRAKA0.31/1.45 AF, CAE HD 03140	0.3/1.4	R142 077 742	1		1.55	0.4	29.7	100		
Mini RG59 Belden 1855A, Draka 0.6/2.8 AF, CAE HD 0628	0.6/2.8	R142 077 702	2	0.85 (.03)	2.85 (.11)	5.42 (.21)	27.68 (1.09)	100	Hexagonal crimp tool 1.73/6.48	
Mini RG59 Argosy Image 360	0.6/2.95	R142 077 712			3.00 (.12)					
RG59 Belden 1505A, Draka 0.8/3.7 AF, CAE HD 08370, Argosy Image 720	0.8/3.7	R142 077 722			3.75 (.15)	6.60 (.26)	26.68 (1.05)			
		R142 085 702			0.90	3.95	6.60			28.68
RG6 Belden 1694A, Draka 1.0/4.8 AF, CAE HD 10460, Argosy Image 1000	1.0/4.8	R142 077 732			1.05 (.04)	4.85 (.19)	7.50 (.30)			26.68 (1.05)
RG11 Belden 7731, Draka 1.6/7.3 AF, CAE HD16720, Argosy Image 2000	1.6/7.3	R142 077 747			1.70	7.45	11.05			32

RIGHT ANGLE PLUG CRIMP TYPE FOR FLEXIBLE CABLE



Cable group	Cable group dia.	Part number	Packaging
RG59 Belden 1505A, Draka 0.8/3.7 AF, CAE HD 08370, Argosy Image 720	0.8/3.7	R142 187 720	100

Jacks and receptacles

STRAIGHT BULKHEAD JACK CRIMP TYPE FOR FLEXIBLE CABLE

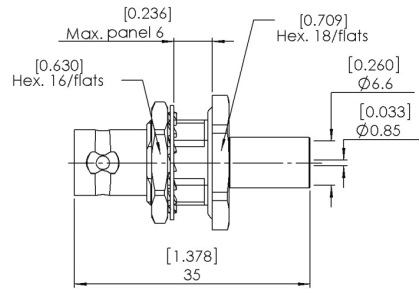

Cable group	Cable group dia.	Part number	Panel drilling	Packaging
RG59 Belden 1505A, Draka 0.8/3.7 AF, CAE HD 08370, Argosy Image 720	0.8/3.7	R142 334 700	P16	100

PCB FEMALE RECEPTACLES

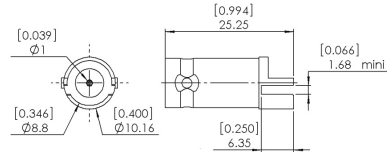

Fig. 1

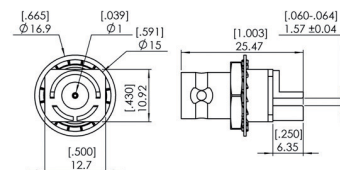

Fig. 2

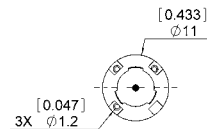
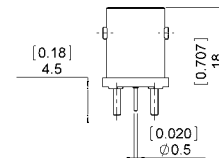
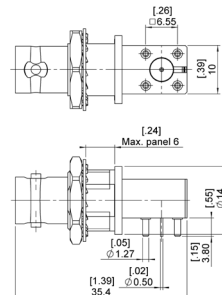

Fig. 3



Part number	Fig.	Captive center contact	Panel drilling	Packaging	Note
R142 568 703	1	yes		100	Edge mount PCB
R142 567 703	2				Bulkhead Edge mount PCB
R142 500 740	3		P20	60	Straight PCB, Zamak

RIGHT ANGLE PCB FEMALE RECEPTACLES



Part number	Captive center contact	Note
R142 676 700	yes	Bulkhead

Adapters

IN SERIES ADAPTERS

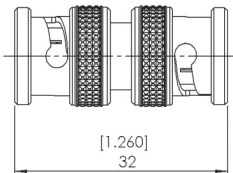

Fig. 1

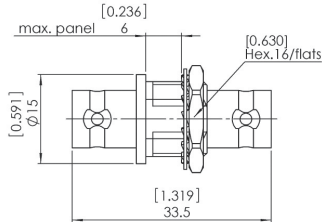

Fig. 2

Part number	Fig.	Captive center contact	Panel drilling	Note	Packaging
R142 703 703	1	yes		male-male	100
R142 720 700	2		P16	female-female	

BETWEEN SERIES ADAPTERS

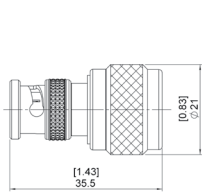

Fig. 1

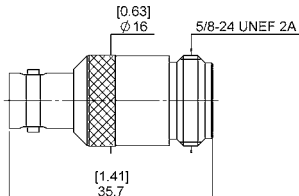
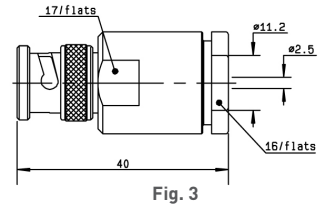
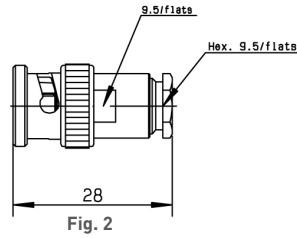
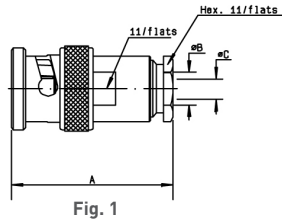

Fig. 2

Part number	Fig.	Captive center contact	Note
R192 417 010	1	yes	BNC HD male - N male
R192 418 010	2		BNC HD female - N female

Straight plugs

STRAIGHT PLUGS CLAMP TYPE



Cable group	Cable group dia.	Part number	Fig.	Dimensions (mm)			Captive center contact	Note
				A	B	C		
RG178 / RG196	2/50/S + D	R141 003 000	1	27	2.2	0.6	yes	
RG174 / RG316 / RD316 / RG179	2.6/50+75/S+D	R141 004 000			3.1			
PPD Cable	3.5/50	R141 005 000	2	28	3.7	1.2	no	
RG58 / RG141	5/50/S	R141 007 000 R141 007 161						
RG58 / RG141 / RG142 / RG223 / RG400	5/50/S + D	R141 008 000	1	28	5.6	1.2	yes	
		R141 009 000						1.05
		R141 010 000						
RG59 / RG62	6/75+93	R141 012 000		27.5	6.6	1.05	no	
RG213 / RG393 / RG214 / RG216	10 + 11/50/S + D	R141 018 000	3				yes	
RG402	.141"	R141 052 000	1	29	3.65	1.2	no	Semi-rigid cable

STRAIGHT PLUGS FULL CRIMP TYPE FOR FLEXIBLE CABLES

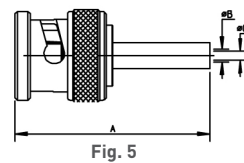
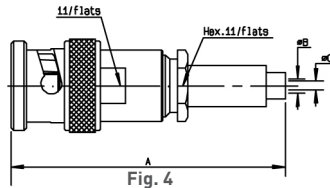
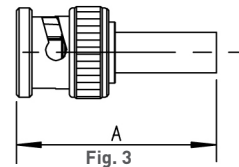
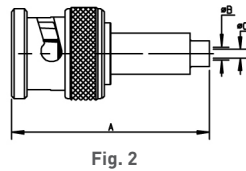
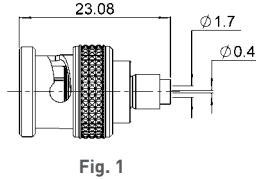

Cable group	Cable group dia.	Part number	Fig.	Dimensions (mm)			Captive center contact	Note
				A	B	C		
RG178 / RG196	2/50/S	R141 070 520	1	23	1.7	0.4	yes	Reverse crimp
RG174 / RG316	2.6/50/S	R141 075 000	2	30.3	1.8	0.6		yes
		R141 075 161					3	
		R141A 075 161				Single piece body ECO version		
	3.8/93/S	R141 077 000	2	28	2.7	0.4		
RG58 / RG14	5/50/S	R141 072 000	4	39	3.1		yes	
		R141 082 000	5	28				1
		R141 082 161	3		30	3.1		
		R141A 082 161						
RG142 / RG223 / RG400	5/50/D	R141 083 000	5	28	3	1.05		Single piece body

Right angle plugs and straight jacks

RIGHT ANGLE PLUGS CLAMP TYPE FOR FLEXIBLE CABLES

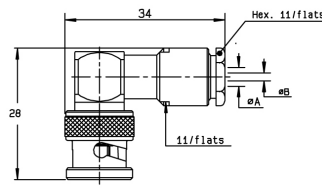

Fig. 1

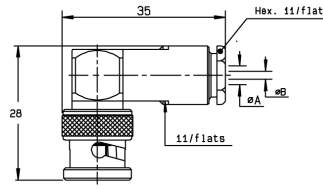

Fig. 2

Cable group	Cable group dia.	Part number	Fig.	Dimensions (mm)		Captive center contact	Note
				A	B		
RG178 / RG196	2/50	R141 153 000	1	2.2	0.6	yes	100 pieces
RG174 / RG316 / RD316 / RG179	2.6/50+75/S+D	R141 154 000		3.1			
RG58 / RG141 / RG142 / RG223 / RG400	5/50/S + D	R141 156 000	2	5.6	1.05		Unit packaging

RIGHT ANGLE PLUGS FULL CRIMP TYPE FOR FLEXIBLE CABLES

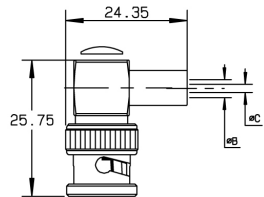

Fig. 1

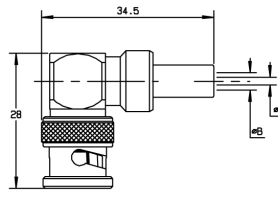

Fig. 2

Cable group	Cable group dia.	Part number	Fig.	Dimensions (mm)		Captive center contact	Note
				B	C		
RG174 / RG316	2.6/50/S	R141 181 161	1	3.25	1.7	yes	Commercial version
		R141 182 000	2	5.5	1.05		Single piece body
RG58 / RG141	5/50/S	R141 182 161	1	5.5	3.15	yes	Commercial version
		R141 182 177	2	5.55	3.2		Non magnetic
RG142 / RG223 / RG400	5/50/D	R141 183 000			5.8	1.05	

STRAIGHT JACKS FOR FLEXIBLE CABLES

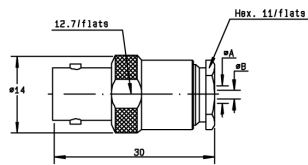

Fig. 1

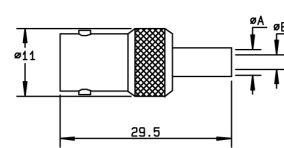

Fig. 2

Cable group	Cable group dia.	Part number	Fig.	Dimensions (mm)		Captive center contact	Note
				A	B		
RG58 / RG141 / RG142 / RG223 / RG400	5/50/S + D	R141 207 000	1	5.6	1.05	no	Clamp type
		R141 208 000					
RG174 / RG316	2.6/50/S	R141 217 000	2	5.5	1.05	yes	Full crimp type
RG58 / RG141	5/50/S	R141 237 000					Single piece body, full crimp type
		R141 237 161					Commercial version, full crimp type
RG142 / RG223 / RG400	5/50/D	R141 220 000					Single piece body, full crimp type

Square flange jacks

STRAIGHT SQUARE FLANGE JACKS CLAMP TYPE FOR FLEXIBLE CABLES

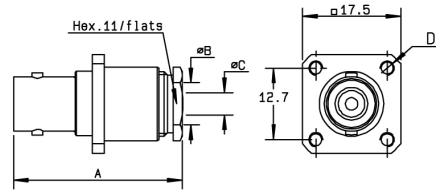
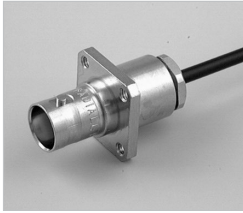

Fig. 1

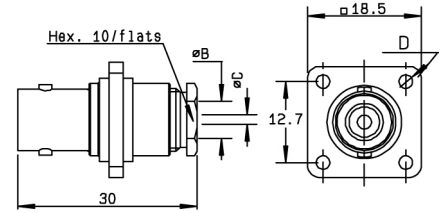

Fig. 2

Cable group	Cable group dia.	Part number	Fig.	Dimensions (mm)				Captive center contact	Panel drilling	Note	
				A	B	C	D				
RG178 / RG196	2/50/S + D	R141 253 000	1	29.5	2.2	0.6	3-56-UNF-2B	yes	P01		
RG174 / RG316 / RD316 / RG179	2.6/50+75/S+D	R141 254 000			3.1					2.7	
		R141 278 000			3					2.6	P01
RG58 / RG141	5/50/S	R141 257 000	1	30	5.6	1.05	2.5	no	P01		
		R141 256 000	2		5.6	1.05				2.6	P02
RG58 / RG141 / RG142 / RG223 / RG400	5/50/S + D	R141 258 000	1	30	5.6	1.05	3-56-UNF-2B	no	P01	Unit packaging	
RG59	6/75	R141 261 000								30	6.5

STRAIGHT SQUARE FLANGE JACKS FULL CRIMP TYPE FOR FLEXIBLE CABLES

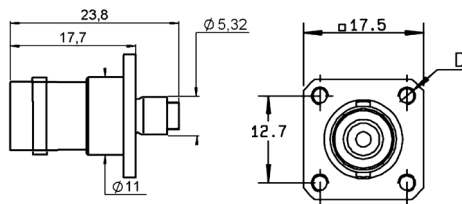

Fig. 1

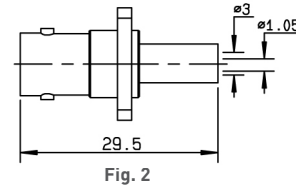

Fig. 2

Cable group	Cable group dia.	Part number	Fig.	Dimensions D (mm)	Captive center contact	Panel drilling	Note
RG174 / RG316	2.6/50	R141 290 200	1	M3 x 0.5	yes	P04	Reverse crimping, Unit packaging
RG58 / RG141	5/50/S	R141 292 000	2	3 x 56 UNEF 2B		P17	Single piece body

Bulkhead jacks

STRAIGHT BULKHEAD JACKS CLAMP TYPE

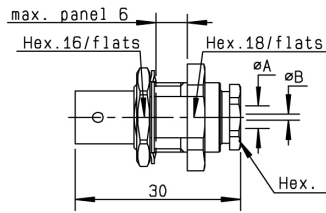

Fig. 1

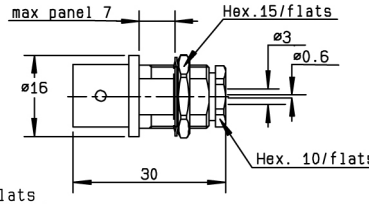

Fig. 2

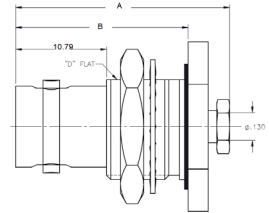

Fig. 3

Cable group	Cable group dia.	Part number	Fig.	Dimensions (mm)		Captive center contact	Panel drilling	Note
				A	B			
RG178 / RG196	2/50/S	R141 323 000	1	2.2	0.6	yes	P11	Panel sealed
RG174 / RG316 / RD316 / RG179	2.6/50+75/S+D	R141 304 000	2	3.1	0.6			Panel sealed
		R141 324 000	1	3.1	0.6			Totally sealed
RG174 / RG316 / RD316	2.6/50/S + D	R141 324 200	1	5.6	1.05	no		Panel sealed
RG58 / RG141 / RG142 / RG223 / RG400	5/50/S + D	R141 327 000	1	3.68	1.27	yes		Panel sealed, non magnetic
		R141 338 000	3	3.65	1.05	no		
RG174 / RG316 / RG179	2.6/50+75S	6501-6571-103	3	27.42	20.98	yes	P11	Panel sealed
RD316	2.6/50D	6501-7551-219	3	25.4	20.47	yes	P11	

STRAIGHT BULKHEAD JACKS CRIMP TYPE FOR FLEXIBLE CABLES

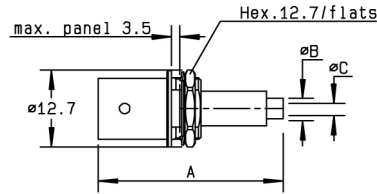

Fig. 1

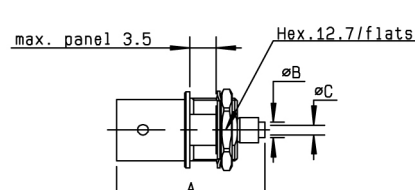

Fig. 2

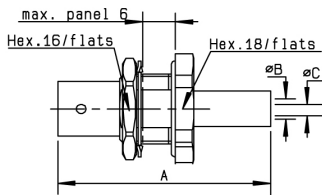

Fig. 3

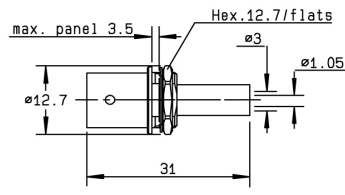
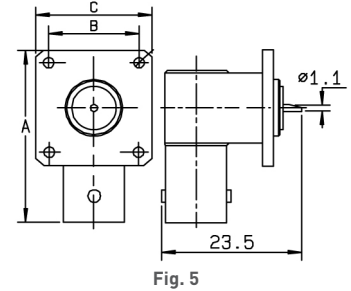
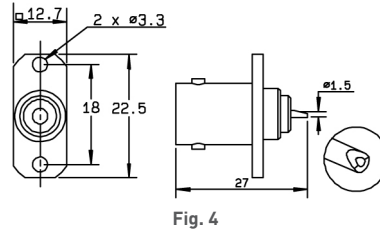
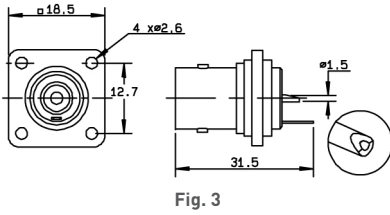
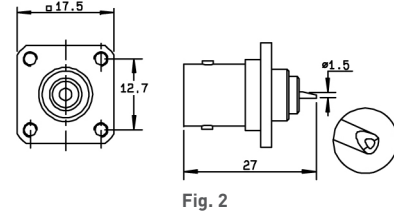
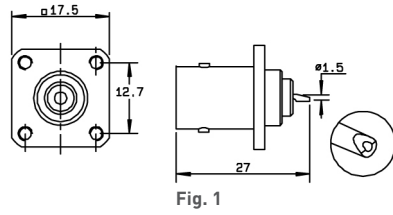

Fig. 4

Cable group	Cable group dia.	Part number	Fig.	Dimensions (mm)			Captive center contact	Panel drilling	Note
				A	B	C			
RG178	2/50S	R141 303 503	2	26.4	2	0.4	yes	P14	Reverse crimping/ commercial version
RD178	2/50D	R141 301 000	1	33.35	1.09	0.6			Reverse crimping/ commercial version
RG174 / RG316	2.6/50/S	R141 306 000	1	34	1.7				
		R141 306 503	2	26	2.95	0.6	P11 or P16	Panel sealed	
		R141 331 500	3	38.5	1.7				
RG58 / RG141	5/50/S	R141A 306 000	1	31	1.7	0.6	no	P14	ECO version
		R141 308 000	4				yes	P11 or P16	Single piece body
RG58 / RG141	5/50/S	R141 332 500	3	35.5	3.1	1.05	yes	P11 or P16	Panel sealed single piece body

Flange receptacles

FLANGE RECEPTACLES



Part number	Fig.	Dimensions (mm)			Captive center contact	Panel drilling	Flange holes	Note
		A	B	C				
R141 403 000	1				yes	P07	4 x M2.5	
R141 404 000	2					P06		
R141 406 000	1					P07	4 x M2.6	
R141 407 000	2					P06		
R141 410 000	3					P02		Insulated flange/solder tag
R141 453 000	4					P18		2 hole flange
R141 654 000	5	26.9	12.7	17.5		P05	4 x M2.6	Right angle receptacle

Bulkhead receptacles

RIGHT ANGLE BULKHEAD RECEPTACLE WITH SOLDER POT

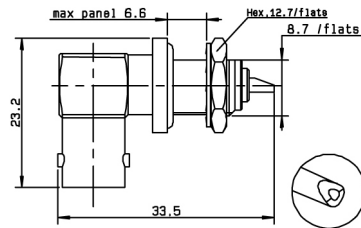
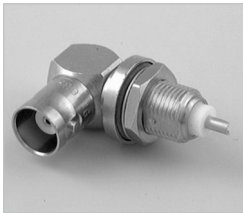

Part number	Captive center contact	Panel drilling
R141 680 000	yes	P14

Bulkhead receptacles

STRAIGHT BULKHEAD RECEPTACLES WITH SOLDER POT

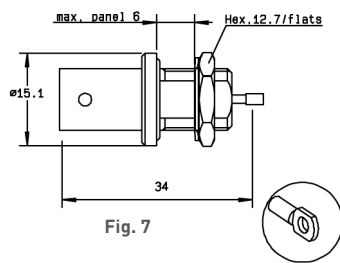
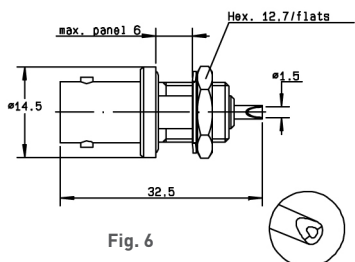
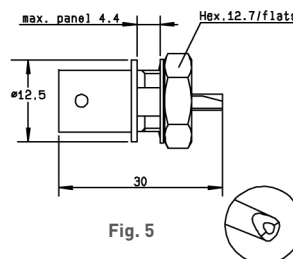
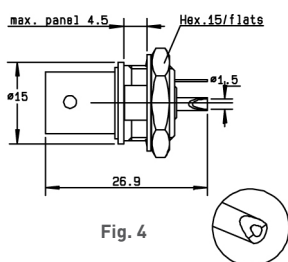
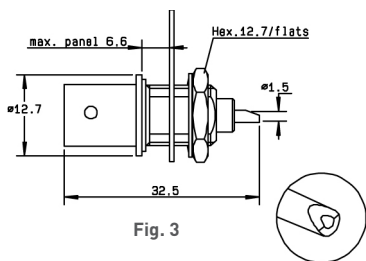
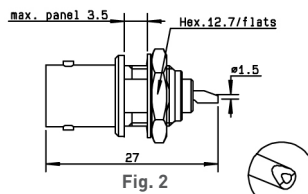
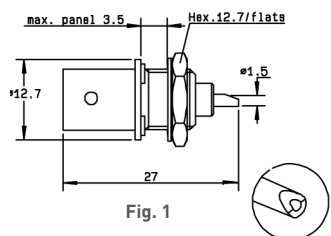

Part number	Fig.	A (Length)	Captive center contact	Panel drilling	Note
R141 554 000	1		yes	P12	
R141 557 000	2			P14	Solder tag
R141 559 000	3				Silver plated center contact/ commercial version
R141 563 161	2			P11	Insulated receptacle + solder tag
R141 572 000	4			P14	Commercial version/insulated
R141 574 000	5				Fully sealed/Q200-5 insulator
R141 574 161	5				Fully sealed
R141 603 000	6			P15	Not sealed/ECO version
R141 605 000					Hermetically sealed
R141A 605 000	3	28			P21
R141 625 000	7			P14	

Receptacles

RECEPTACLES

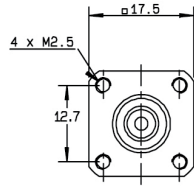
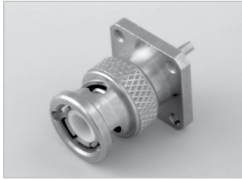

Fig. 1

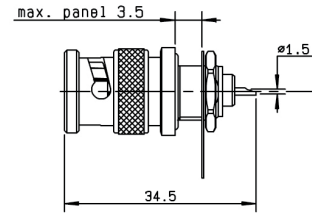
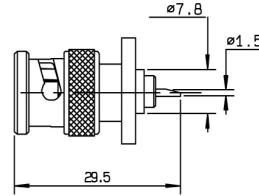

Fig. 2

Part number	Fig.	Captive center contact	Panel drilling	Note
R141 440 000	1		P03	Male square flange
R141 580 000	2	yes	P14	Male bulkhead / Panel sealed / Solder tag

STRAIGHT PCB FEMALE RECEPTACLES

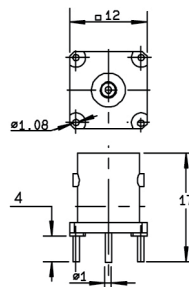

Fig. 1

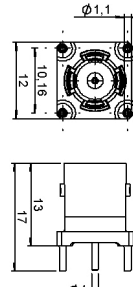

Fig. 2

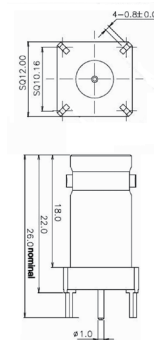

Fig. 3

Part number	Fig.	Captive center contact	Panel drilling	Note
R141 426 000	1		P08	Die cast body / Commercial version
R141 426 161	2	yes		
R141 426 168	3			

RIGHT ANGLE PCB FEMALE RECEPTACLES

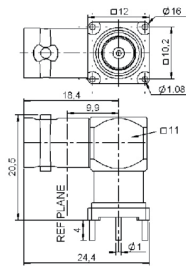
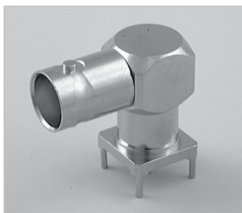

Fig. 1

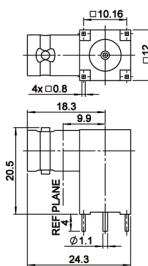
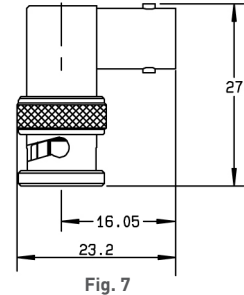
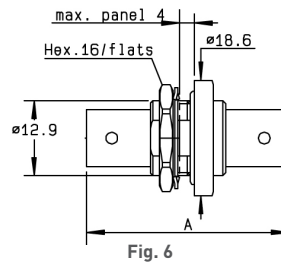
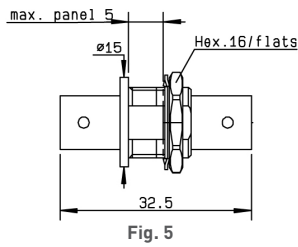
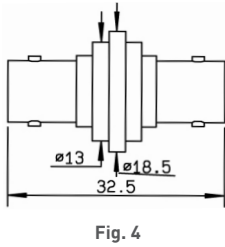
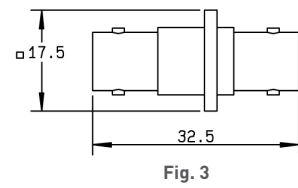
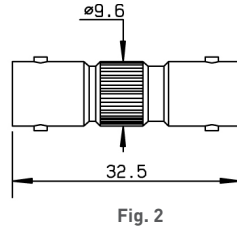
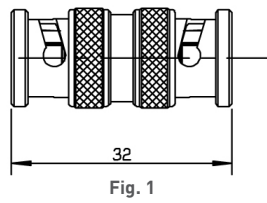

Fig. 2

Part number	Fig.	Captive center contact	Panel drilling	Finish	Note
R141 665 000	1		P19	Nickel	
R141 665 200	2	yes	P08		

Adapters

IN SERIES ADAPTERS



Part number	Fig.	Captive center contact	Dimension A (mm)	Flange holes	Panel drilling	Note		
R141 703 000	1	yes				male - male		
R141 704 000	2					female - female		
R141 710 000	3				4 x M2.5	P10	female - female square flange	
R141 717 000	4				4 x 2.6	P02	female - female square insulated flange	
R141 720 000	5					P13	female - female bulkhead	
R141A 720 000							female - female bulkhead/ECO version	
R141 723 000							P13 or P16	female - female insulated bulkhead
R141 723 161								female - female insulated bulkhead/commercial version
R141 730 000	6			35.7		P13	female - female panel sealed bulkhead	
R141 753 000				35.3			female - female hermetically sealed bulkhead	
R141 770 000	7						male - female right angle	

Adapters and caps

CROSS AND TEE IN SERIES ADAPTERS

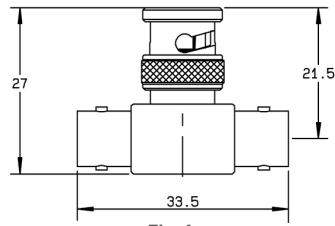

Fig. 1

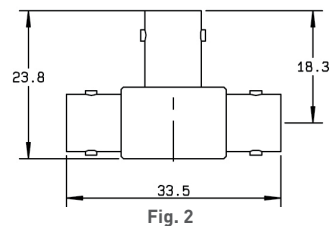

Fig. 2

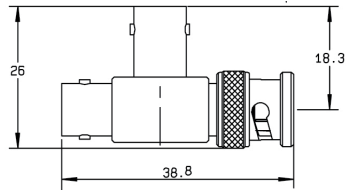

Fig. 3

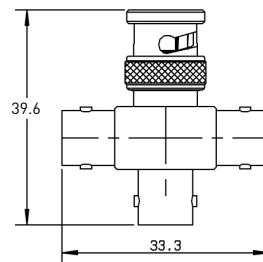

Fig. 4

Part number	Fig.	Captive center contact	Note
R141 780 000	1	yes	male/female-female tee
R141 782 000	2		female/female-female tee
R141 789 000	3		female/female-male tee
R141 799 000	4		male/female-female-female cross/unit packaging

MALE AND FEMALE CAPS

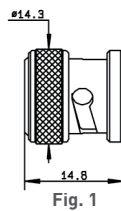

Fig. 1

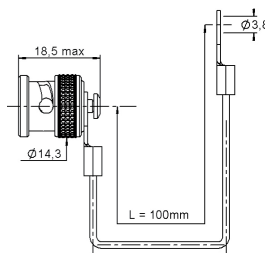

Fig. 2

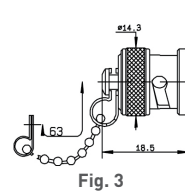

Fig. 3

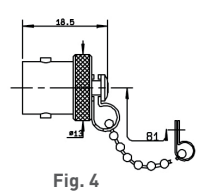

Fig. 4



Part number	Fig.	Note
R141 802 000	1	male
R141 805 000	2	male with cord
R141 812 000	3	male with chain
R141 842 000	4	female with chain
R141 862 000	3	male short circuit / with chain

Straight plugs

STRAIGHT PLUGS CLAMP TYPE FOR FLEXIBLE CABLES

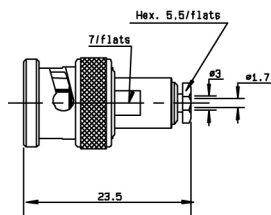
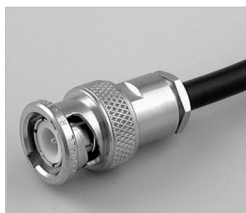

Fig. 1

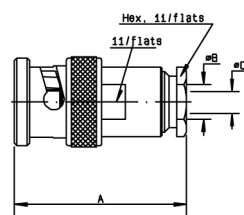

Fig. 2

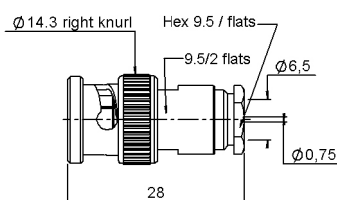

Fig. 3

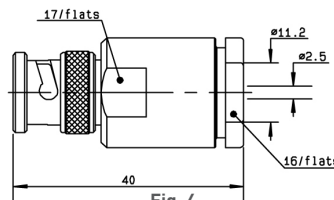

Fig. 4

Cable group	Cable group dia.	Part number	Fig.	Dimensions (mm)			Captive center contact	Note
				A	B	C		
RG179	2.6/75/S	R142 004 000	1				yes	
RG59 / RG62	6/75/S	R142 016 000	2	28	6.6	0.75		Unit packaging
		R142 016 161	3					Commercial version
RG6A / U	8/75/S + D	R142 017 000	2	45.5	9.1	1.5		Unit packaging
RG216 / RG11 / RG12 / RG144	10 + 11/75/S + D	R142 018 000	4				yes	
RG6A / U	GORE cable	6500-7071-046	2	23.87	4.31	2.79		

STRAIGHT PLUGS FULL CRIMP TYPE FOR FLEXIBLE CABLES

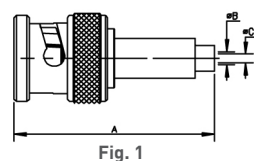

Fig. 1

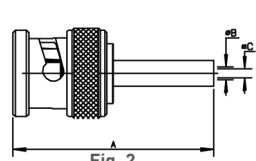

Fig. 2

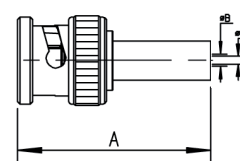
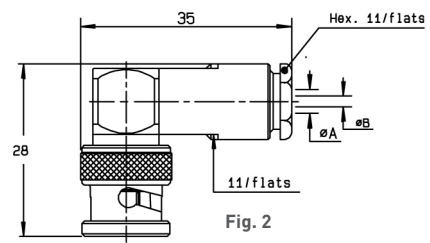
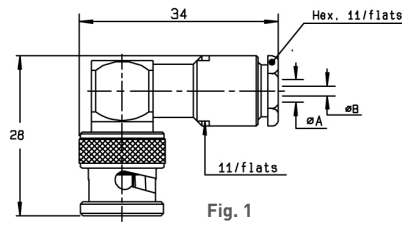

Fig. 3

Cable group	Cable group dia.	Part number	Fig.	Dimensions (mm)			Captive center contact	Note
				A	B	C		
RG179	2.6/75/S	R142 076 000	1	31	1.8	0.4	yes	
		R142 076 161	3					Commercial version
		R142A 076 161	3	25.3	1.65	0.4	no	Single piece body / ECO version
BT3002	3.6/75/D	R142 081 120	2	29	2.1	0.34		Single piece body
		R142 081 130		29	2.1	0.34		Single piece body / unit packaging
		R142A 081 130		29	2.1	0.34		Single piece body / ECO version
ST212		R142 091 161	3	30	2.1	0.6	yes	
BT2002	5/75/D	R142 083 000	2	27.3	5.5			Single piece body
		R142 085 000		28	6.6	0.75		
RG59 / RG62	6/75/S	R142 085 161	3	28	3.9			Single piece body / Commercial version
		R142A 085 161		29	4	0.8	no	Single piece body / ECO version
		R142 086 161		30.8	5.15	1.35		Single piece body / Commercial version
RG11 / RG12 / RG144	7.5/75/S	R142 090 000	2	28	5.25	0.85	yes	
	10/75/S	R142 095 000		28	11.05	1.35		Single piece body

Right angle plugs and jacks

RIGHT ANGLE PLUGS CLAMP TYPE FOR FLEXIBLE CABLES



Cable group	Cable group dia.	Part number	Fig.	Dimensions (mm)		Captive center contact
				A	B	
RG179	2.6/75/S	R142 154 000	1	3.1	0.6	yes
RG59 / RG62	6/75/S	R142 157 000	2	6.6	0.75	

RIGHT ANGLE PLUGS FULL CRIMP TYPE FOR FLEXIBLE CABLES

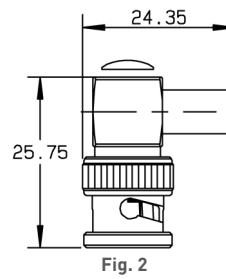
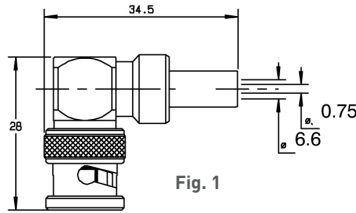

Cable group	Cable group dia.	Part number	Fig.	Captive center contact	Note
RG59 / RG62	6/75/S	R142 184 000	1	yes	
		R142 184 161	2		Commercial version

STRAIGHT JACKS FULL CRIMP TYPE FOR FLEXIBLE CABLES

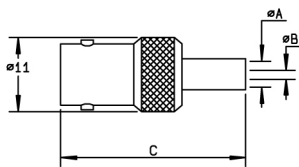

Cable group	Cable group dia.	Part number	Dimensions (mm)			Captive center contact	Note
			A	B	C		
RG179	2.6/75/S	R142 217 000	1.75	0.4	32.5	yes	
RG59 / RG62	6/75/S	R142 242 000	6.6	0.75	29.5		Single piece body
		R142 242 161			29		Single piece body/commercial version

Jacks and bulkhead jacks

STRAIGHT SQUARE FLANGE JACKS CLAMP TYPE FOR FLEXIBLE CABLES

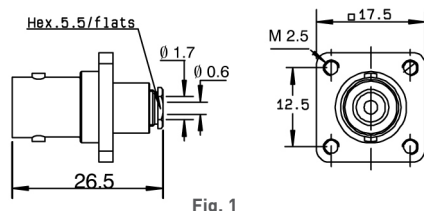

Fig. 1

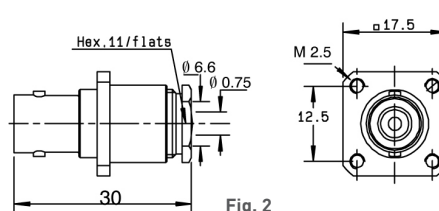
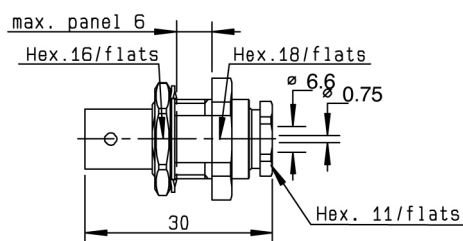

Fig. 2

Cable group	Cable group dia.	Part number	Fig.	Captive center contact	Panel drilling	Note
RG179	2.6/75/S	R142 202 000	1	yes	P01	Unit packaging
RG59 / RG62	6/75/S	R142 268 000	2			

STRAIGHT BULKHEAD JACK CLAMP TYPE FOR FLEXIBLE CABLES



Cable group	Cable group dia.	Part number	Captive center contact	Panel drilling	Note
RG59 / RG62	6/75/S	R142 329 000	yes	P11	Panel sealed

STRAIGHT BULKHEAD JACKS CRIMP TYPE FOR FLEXIBLE CABLES

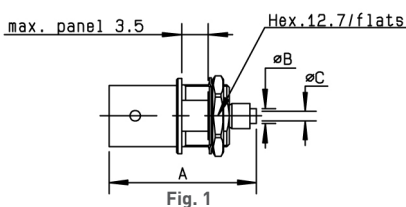

Fig. 1

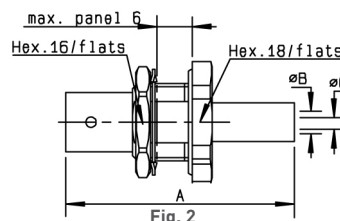

Fig. 2

Cable group	Cable group dia.	Part number	Fig.	Dimensions (mm)			Captive center contact	Panel drilling	Note
				A	B	C			
RG179	2.6/75/S	R142 306 500	1	26	2.95	0.4	yes	P14	Reverse crimping/Commercial version
		R142A 306 500					no		Reverse crimping/ECO version
		R142 306 503					yes		Reverse crimping
		R142 331 011							
BT3002	3.6/75/D	R142A 325 106	2	38	1.75	0.4	no	P11 or P16	Panel sealed/Silver plated
		36		2.1	0.5		Panel sealed/ECO version		
RG59 / RG62	6/75/S	R142 334 161	2	35	6.6	0.75	yes	P11 or P16	Panel sealed/Commercial version
		R142A 334 161		35	3.8	0.7			Panel sealed/ECO version

Receptacles

RECEPTACLES WITH SOLDER POT

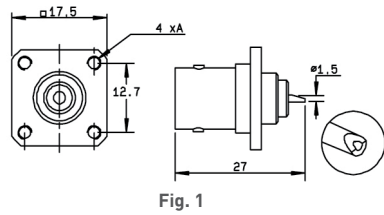

Fig. 1

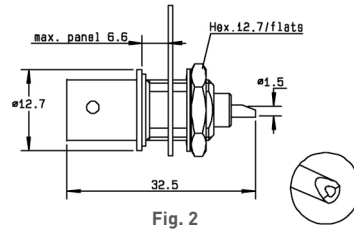
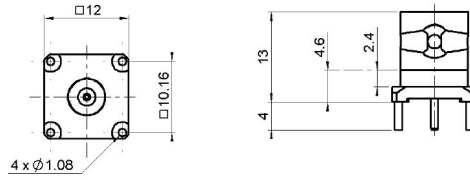
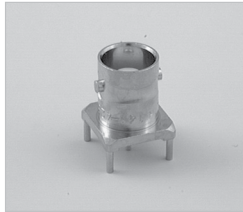

Fig. 2



Part number	Fig.	Captive center contact	Panel drilling	Flange holes A	Note
R142 412 000	1	yes	P06	4 x M2.5	Square flange + unit packaging
R142 562 000	2		P14		Bulkhead female receptacle Unit packaging

STRAIGHT PCB FEMALE RECEPTACLES



Part number	Captive center contact	Panel drilling
R142 426 000	yes	P08

RIGHT ANGLE PCB FEMALE RECEPTACLE

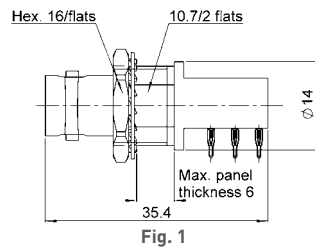

Fig. 1

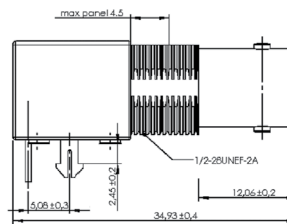

Fig. 2

Part number	Fig.	Captive center contact	Panel drilling	Note
R142 684 130	1	yes	P09 and P16	Press-fit pins
R142 676 430	2		yes	Harpoon legs

Adapters

IN SERIES ADAPTERS

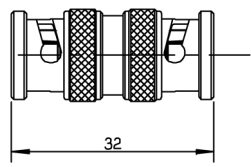

Fig. 1

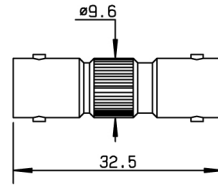

Fig. 2

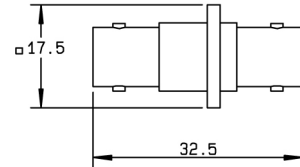

Fig. 3

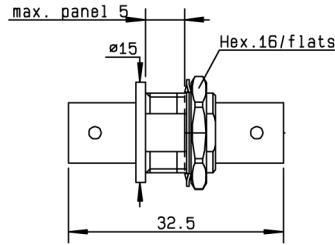

Fig. 4

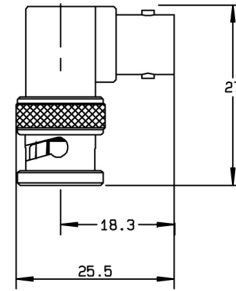

Fig. 5

Part number	Fig.	Captive center contact	Panel drilling	Note
R142 703 000	1	yes	P01 P11 P11 or P16	male - male
R142 704 000	2			female - female
R142 710 000	3			female - female square flange
R142 720 000	4			female - female bulkhead
R142 723 000	4			female - female insulated bulkhead
R142 770 000	5			male - female right angle

TEE IN SERIES ADAPTERS

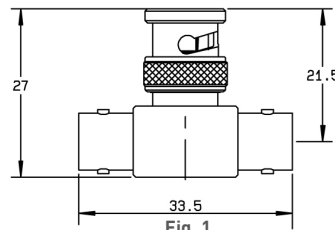

Fig. 1

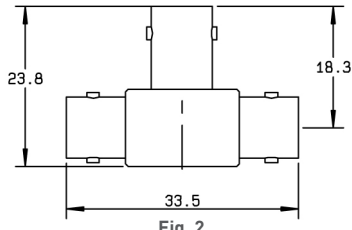

Fig. 2

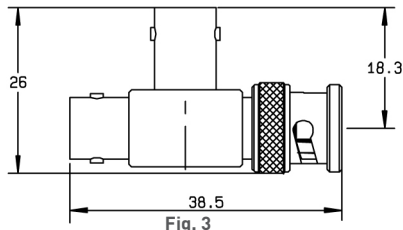

Fig. 3

Part number	Fig.	Captive center contact	Note
R142 780 000	1	yes	male / female-female tee
R142 782 000	2		female / female-female tee
R142 789 000	3		female / female-male tee

Characteristics

Test / Characteristics	Values / Remarks	
Frequency range	DC - 10 GHz	
Impedance	50Ω	
Working voltage	500 Vrms	
Dielectric withstanding voltage <ul style="list-style-type: none"> • Between center conductor and inner screen • Between inner screen and outer screen 	Unmated connector 1500 Vrms 1000 Vrms	Mated connector 3000 Vrms 1000 Vrms
Temperature range	-55°C / +125°C	

Plug, jack and receptacle

STRAIGHT PLUG CLAMP TYPE

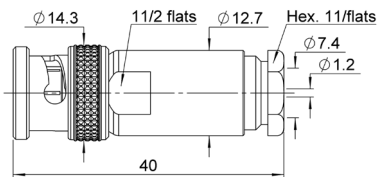

Cable group dia.	Part number
7.3 / 50 / D	R266 010 000

STRAIGHT JACK CLAMP TYPE

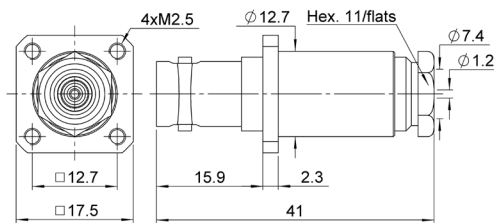

Cable group dia.	Part number	Panel Drilling
7.3 / 50 / D	R266 260 000	P10

RECEPTACLE

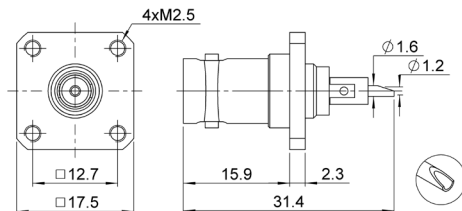

Part number	Panel Drilling
R266 403 000	P10

Panel drilling

P01

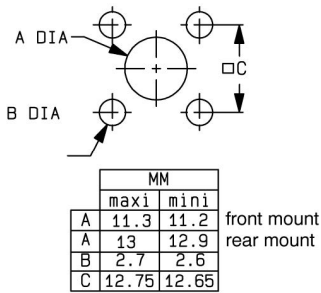

P02

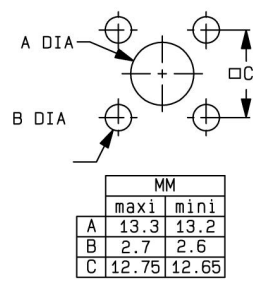

P03

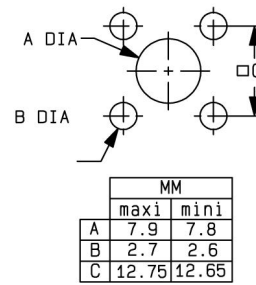

P04

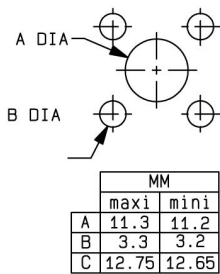

P05

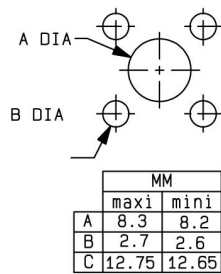

P06

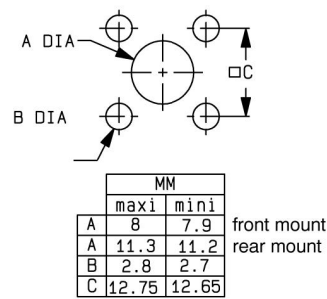

P07

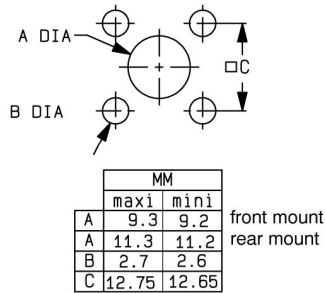

P08

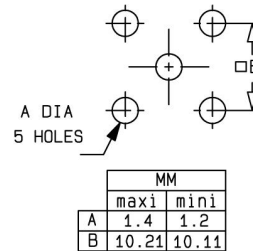

P09

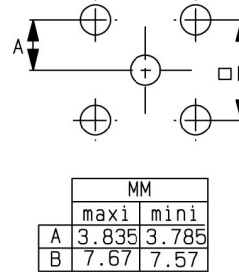

P10

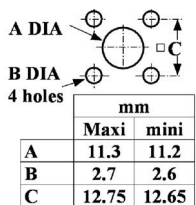

P11

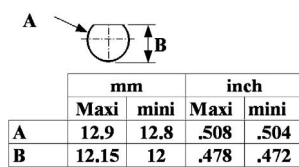

P12

