

**M8 female 0° A-cod. with cable**

PVC 3x0.25 ye UL/CSA 3m

Female straight

M8, 3-pole

Art-No. 7005 - M8 Lite - (plastic hexagonal screw) on request with cable sleeves

Plastic housings with good resistance against chemicals and oils.

The resistance to aggressive media should be individually tested for your application. Further details on request.

Further cable lengths on request.

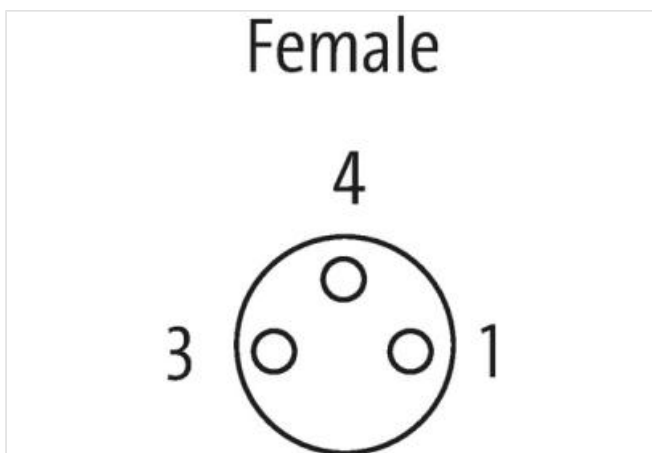
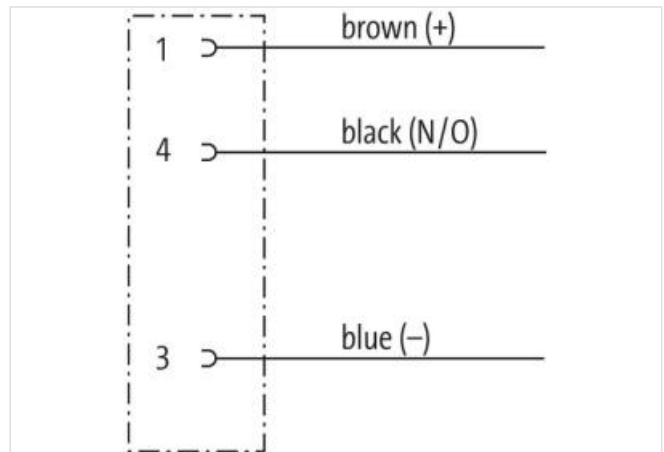
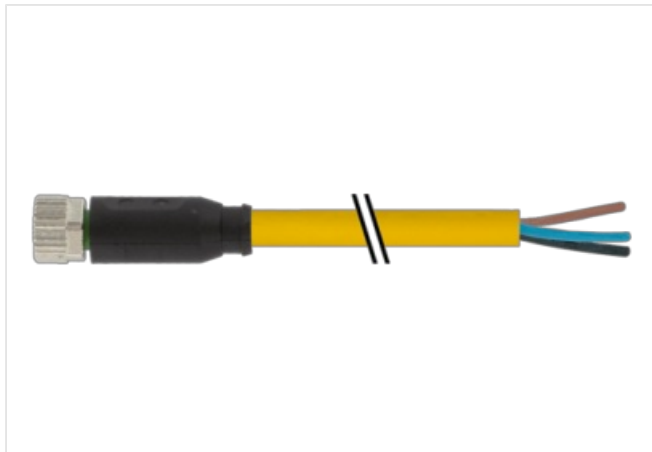
[Link to Product](#)**Illustration**

Product may differ from Image

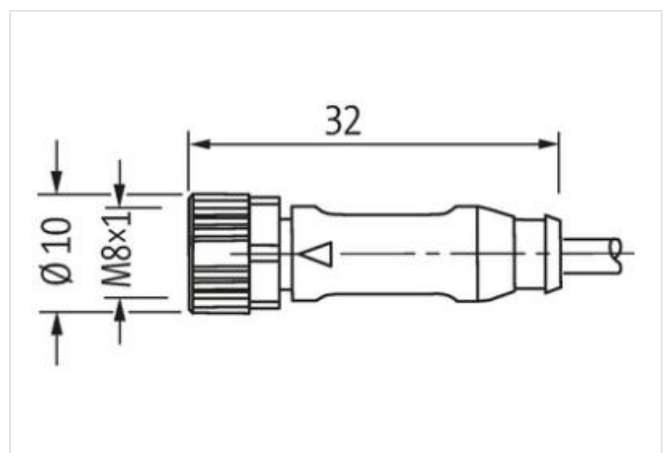

Cable length

3 m

**Side 1**

Tightening torque head 1	0,4 Nm
Mounting method	inserted, screwed
Coating contact head 1	gold plated
Family form head 1	M8
Thread	M8 x 1
Inner diameter contour for corrugated hose head 1	6,5 mm
Material contact	Copper alloy
Material head 1	PUR
Number of poles head 1	3
Width across flats head 1	SW9
Degree of protection (EN IEC 60529)	IP65, IP66K, IP67

**Side 2**

Stripping length (jacket)	20 mm
Coating contact head 2	gold plated

**Commercial data**

ECLASS-6.0	27279218
ECLASS-6.1	27279218
ECLASS-7.0	27279218
ECLASS-8.0	27279218
ECLASS-9.0	27060311
ECLASS-10.1	27060311
ECLASS-11.1	27060311
ECLASS-12.0	27060311
ETIM-5.0	EC001855
customs tariff number	85444290
GTIN	4048879231794
Packaging unit	1

**Electrical data | Supply**

Operating voltage AC (UL-listed)	30 V
Operating voltage AC max.	50 V
Operating voltage DC (UL-listed)	30 V
Operating voltage DC max.	60 V
Current operating per contact max.	4 A

**Diagnostics**

Status indication LED	no
-----------------------	----

**Installation | Connection**

Stripping length (jacket)	20 mm
Mounting set	M8 x 1

**Device protection | Electrical**

Rated surge voltage	1,5 kV
Material group (IEC 60664-1)	I
Protection degree additional condition	inserted, screwed
Pollution Degree	3

**Mechanical data | Material data**

Coating locking	Nickeled
Coating of fitting	nickel plated
Material gasket	FKM
Locking material	Zinc die-casting
	Zinc die-casting

**Mechanical data | Mounting data**