

Altech Corp.®

Your Source for Automation & Control Components



Harsh Environment Capability



Unique Air Ventilation System

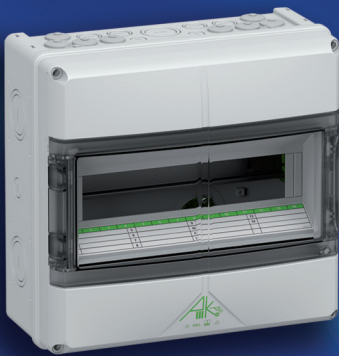

INDUSTRIAL ENCLOSURES GEOS & AKIII Series

GEOS

Tough • Flexible • Safe

GEOS - Industrial Outdoor Enclosure

High quality materials and an innovative design make the new GEOS series a universal solution and long lasting enclosure for indoor and outdoor applications. The UV and weather resistance of the high-quality polycarbonate and the new and innovative "Drain Protect" seal system guarantee optimal protection against most environmental influences, as well as rain, cold and heat. Even in tough conditions caused by aggressive atmospheres, oils, greases or mechanical stresses, you can rely on the GEOS enclosure. Certifications for the most varied applications give the user confidence at all times.

Tough

- UV and weather resistant
- Corrosion resistant
- Temperature resistant -35° to 80°C
- Rugged
- High impact resistance - IK 09

Flexible

- Modular component mounting system
- Lightweight
- Easily machined
- Multiple mounting and closure options

Safe

- Drain Protect seal system
- Air ventilation element option
- High protection rating IP67
- Insulated protection
- Safety agency approvals (cULus Type 4X)

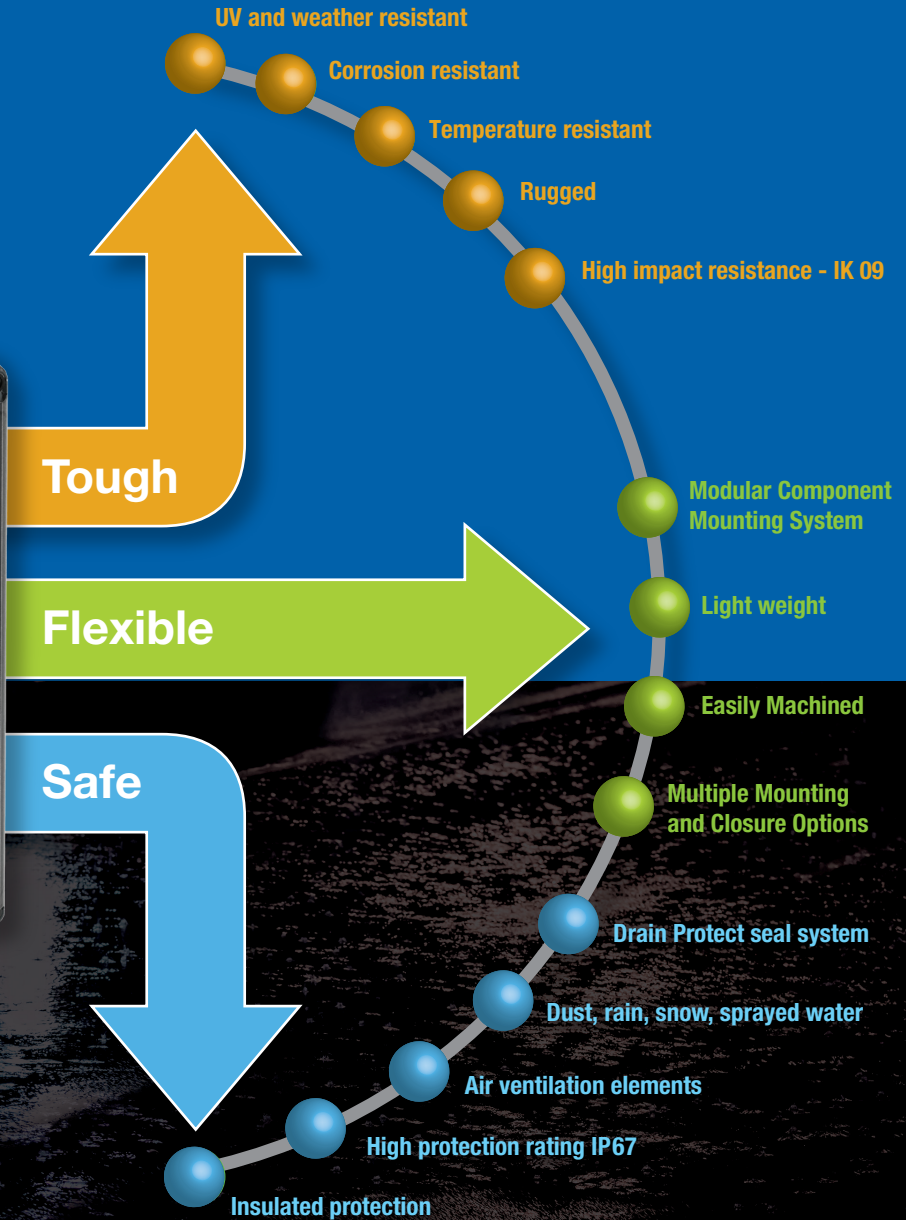
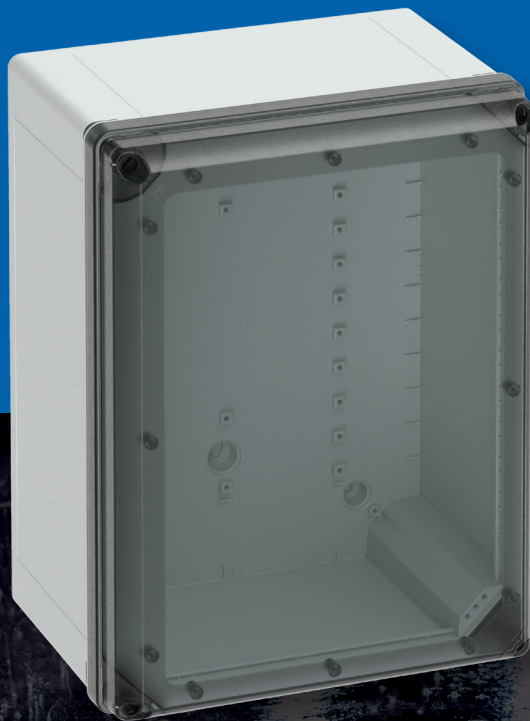

The GEOS Family ranging up to 15.75 x 19.69 x 8.9 in.



Modular Component Mounting Features

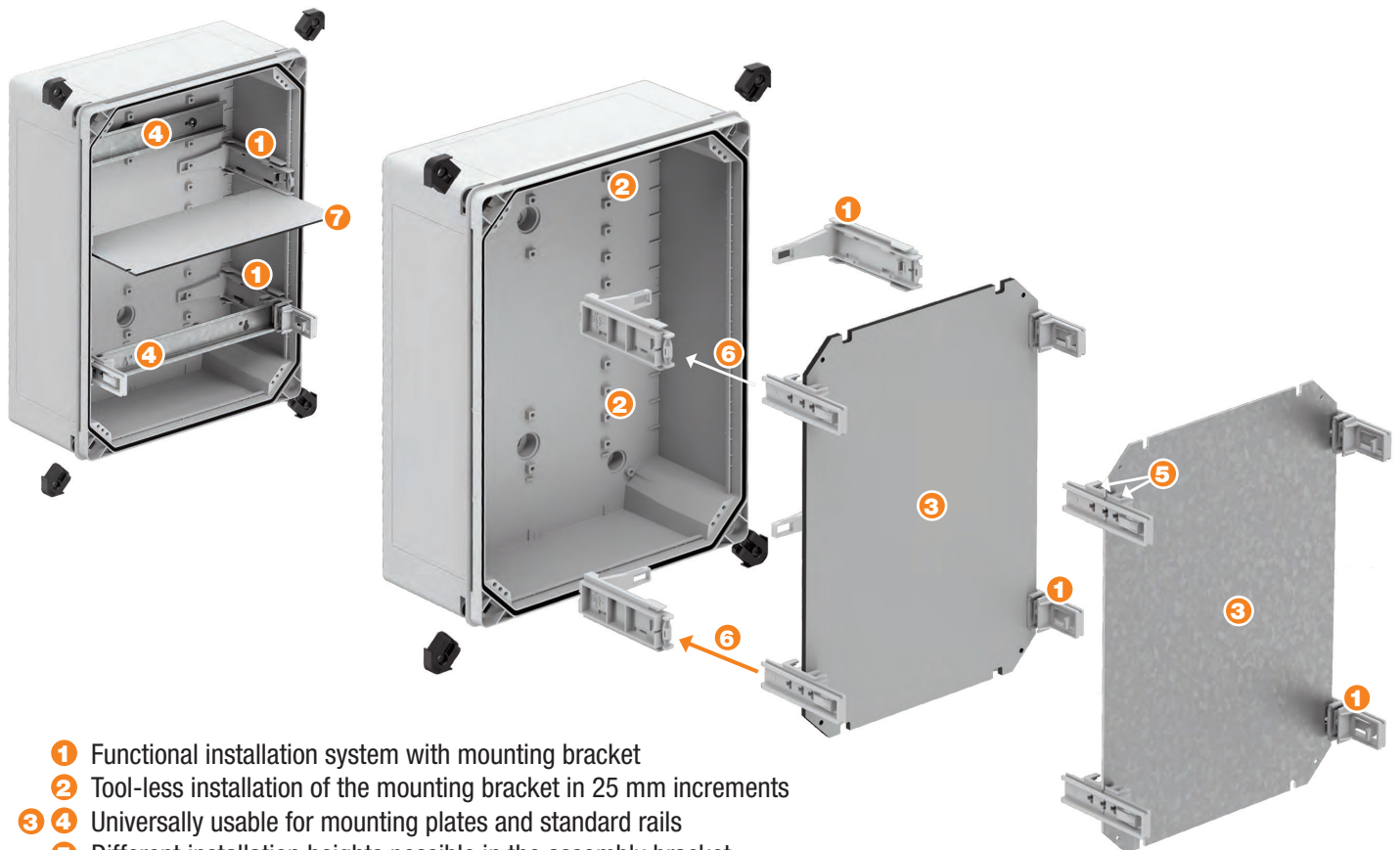

- 1 Functional installation system with mounting bracket
- 2 Tool-less installation of the mounting bracket in 25 mm increments
- 3 4 Universally usable for mounting plates and standard rails
- 5 Different installation heights possible in the assembly bracket
- 6 Subsequent insertion of assembled modules
- 7 Partition walls



All round protection through "Drain Protect"

- Lasting protection against moisture
- Diverts moisture to backside of enclosure

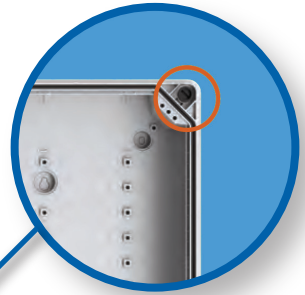

Mounting outside the sealing area

- UL-compliant installation
- Installation of assembled enclosure
- Maintains seal ratings

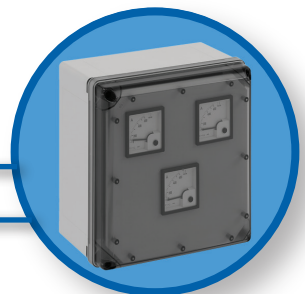

Mounting standoffs in the cover or on top of the base

- Used for installing displays and controls behind the cover

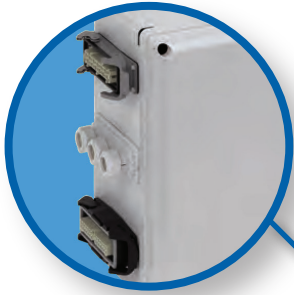

Optimized box dimensions

- Flexible assembly of heavy-duty industrial plug-in connectors.
- For universal use in different applications
- Sidewall will fit Bel Air M40 ventilation set.

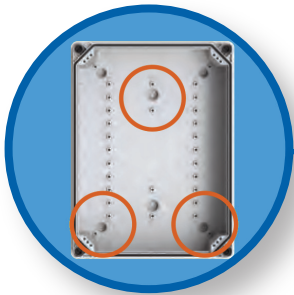

Three-point mounting

- Easy installation via keyhole mounting



1/4 turn screws

- Easy access via 1/4 turn screws as standard
- Conventional screws available, see page 13



Screw position is visibly verifiable.



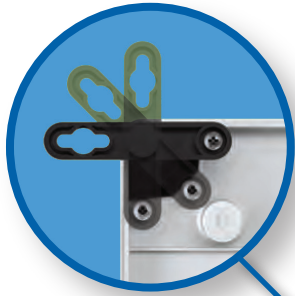

Optional external fastening

- Installation of assembled enclosures
- Available in 2 heights (10 mm or 40 mm)
- Clearance from wall for optimum laying of cables
- Installs at 0°, 45°, 90°

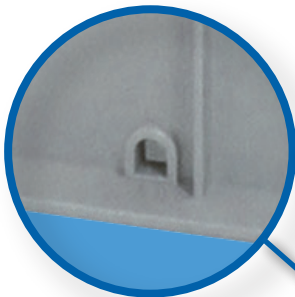

Optional Drain Knockout

- Use of optional drain knockouts will reduce IP rating

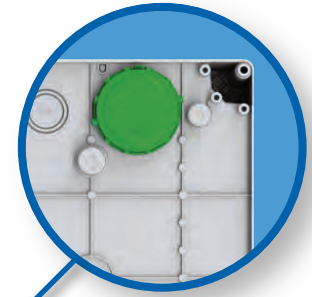
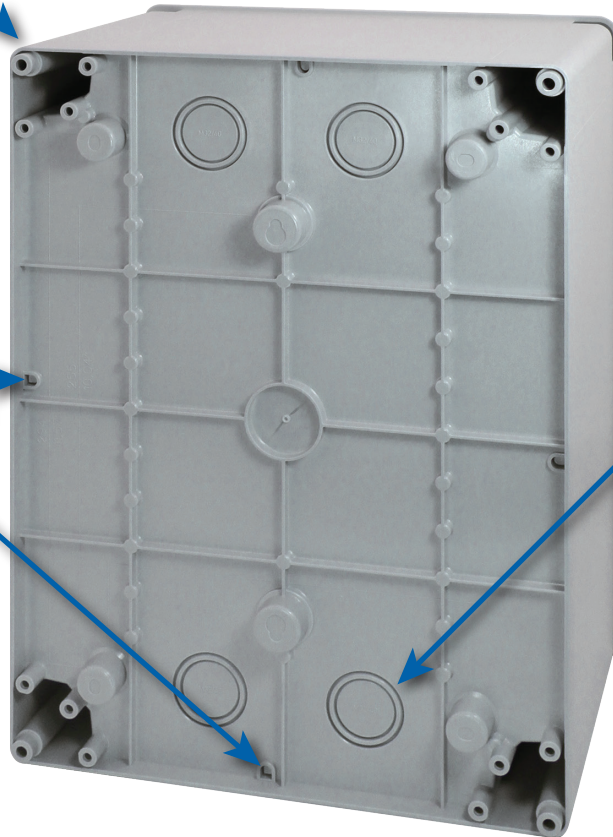

Protection against condensate water

- Preparation for BEL Air M40 ventilation elements (IP65 / UL Type 3R)

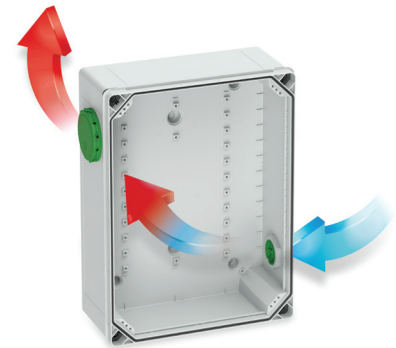

The Ventilation Element

The BEL Air ventilation element prevents condensation, while maintaining a high IP65 protection rating. Any condensation occurring is transported out of the enclosure immediately via air exchange. The continuous and high rate of air exchange allows the interior air to mix constantly with the environmental air and transports the moisture outwards. Air exchange also takes place in environments with almost constant air humidity and temperature, as the air in the interior of the enclosure heats up due to the components. Due to the permanent pressure equalization, all the enclosure parts, such as the seal, are relieved of pressure permanently.



Mounting option BEL Air M40

- M32/40 knockouts in the base
- The wall clearance is suitable for installing BEL Air M40 ventilation elements at ground level
- Option of mounting on the sides of the enclosure (milling of sidewall holes required)

Advantages

- Prevention of condensation while maintaining a high IP 65 protection rating
- High air exchange rate
- 100% Pressure equalization
- 100% Protection against foreign bodies
- Maintenance-free



Cat No. 700-433
GEOS-L 3030-18-o
 with grey cover



Cat No. 701-433
GEOS-L 3030-18-to
 with transparent cover

Description

Empty enclosure - Industrial Quality, suitable for installation in harsh environments and in unprotected outdoor areas.
 Material: glass-fiber reinforced Polycarbonate, grey, similar to RAL 7035.

Size: 300 x 300 x 180 mm
 11.8 x 11.8 x 7.1 in



Dimensions

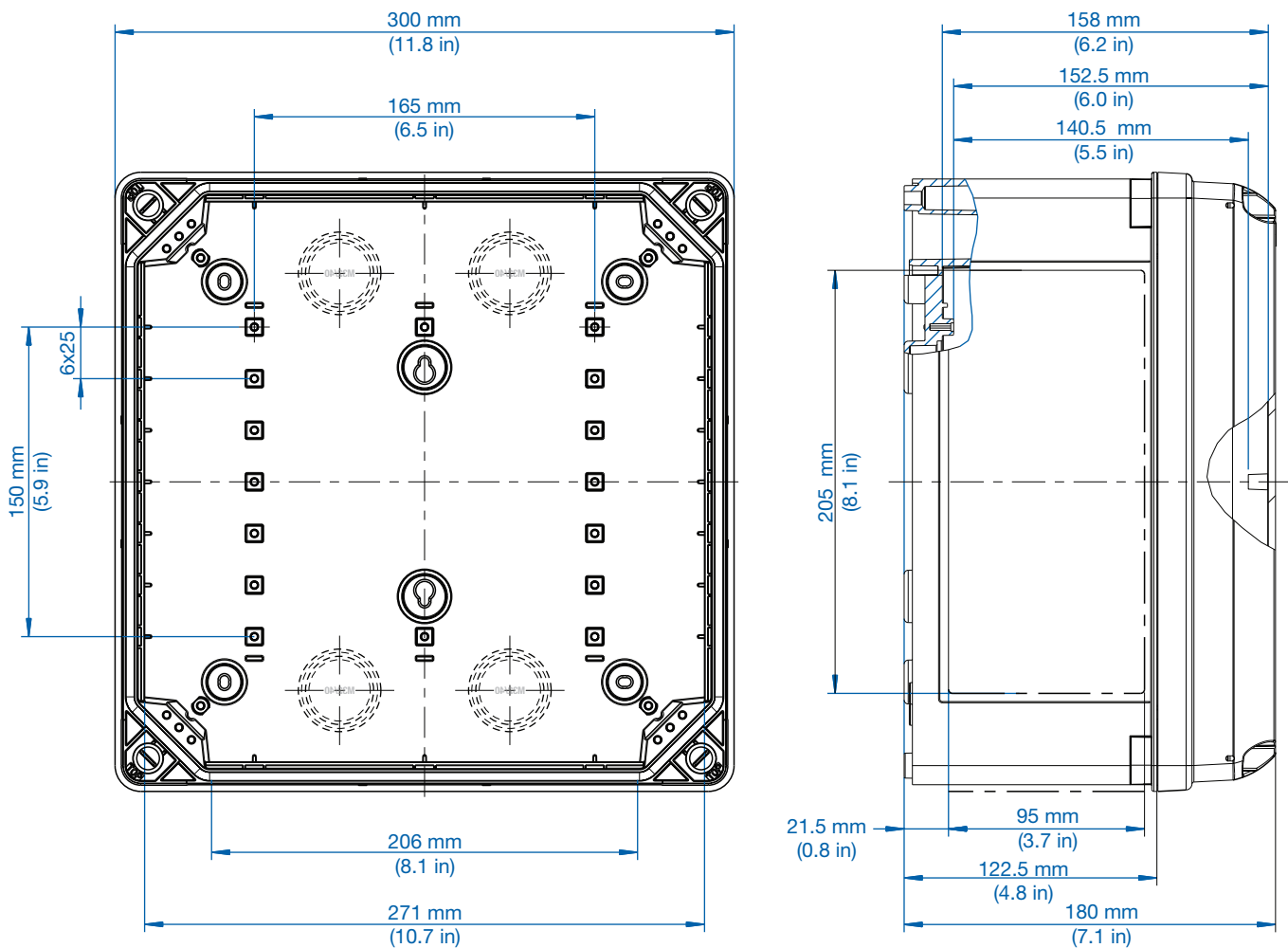

See pages 19-24 for accessories.



Cat No. 700-733
GEOS-L 3030-22-o
 with grey cover

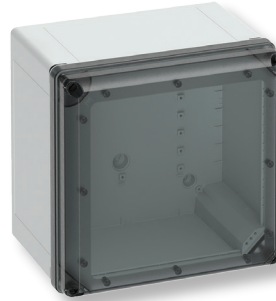

Cat No. 701-733
GEOS-L 3030-22-to
 with transparent cover

Description

Empty enclosure - Industrial Quality, suitable for installation in harsh environments and in unprotected outdoor areas.

Material: glass-fiber reinforced Polycarbonate, grey, similar to RAL 7035.

Size: 300 x 300 x 226 mm

11.8 x 11.8 x 8.9 in



Dimensions

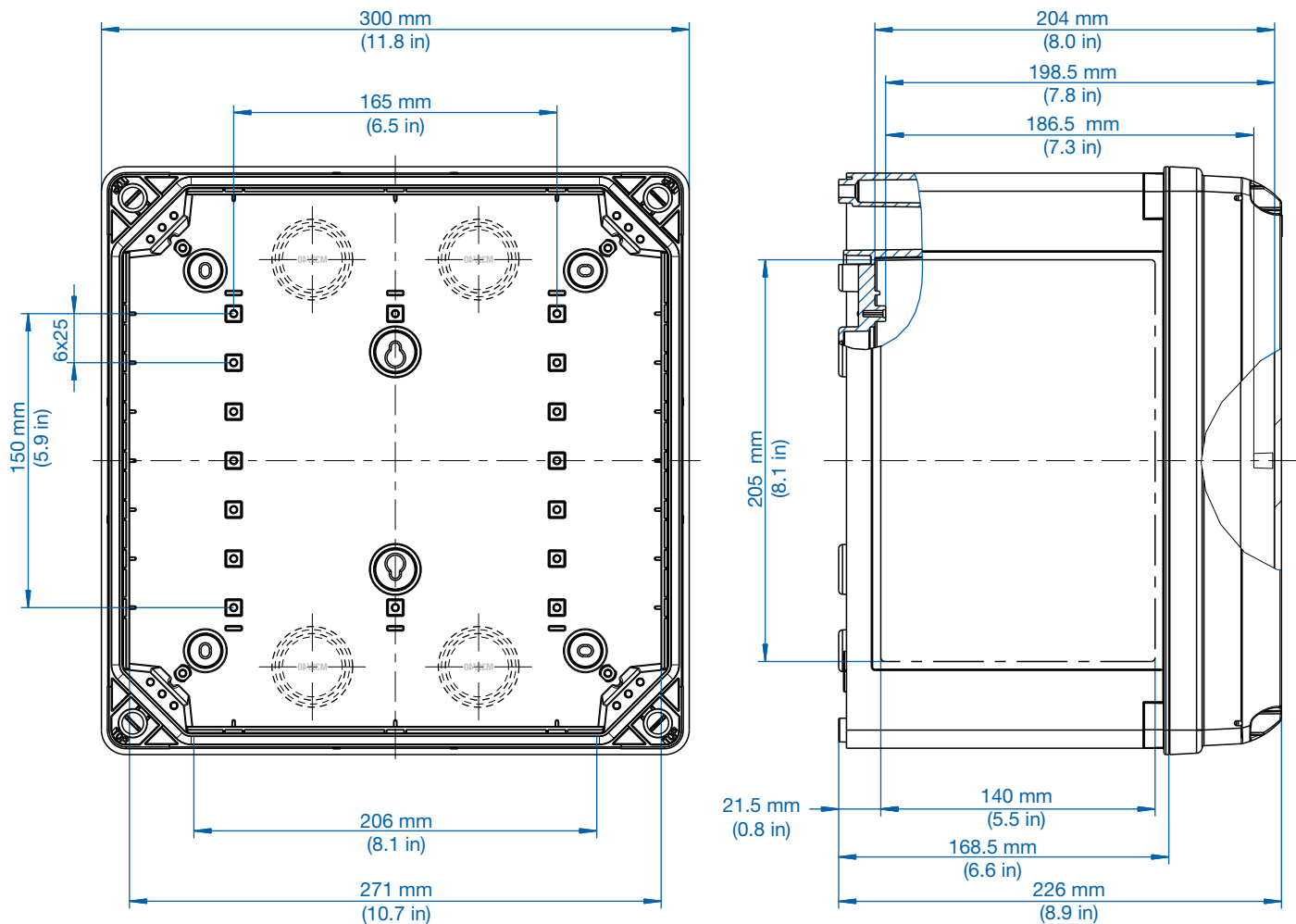

See pages 19-24 for accessories.



Cat No. 700-434
GEOS-L 3040-18-o
 with grey cover



Cat No. 701-434
GEOS-L 3040-18-to
 with transparent cover

Description

Empty enclosure - Industrial Quality, suitable for installation in harsh environments and in unprotected outdoor areas.
 Material: glass-fiber reinforced Polycarbonate, grey, similar to RAL 7035.

Size: 300 x 400 x 180 mm
 11.8 x 15.7 x 7.1 in



Dimensions

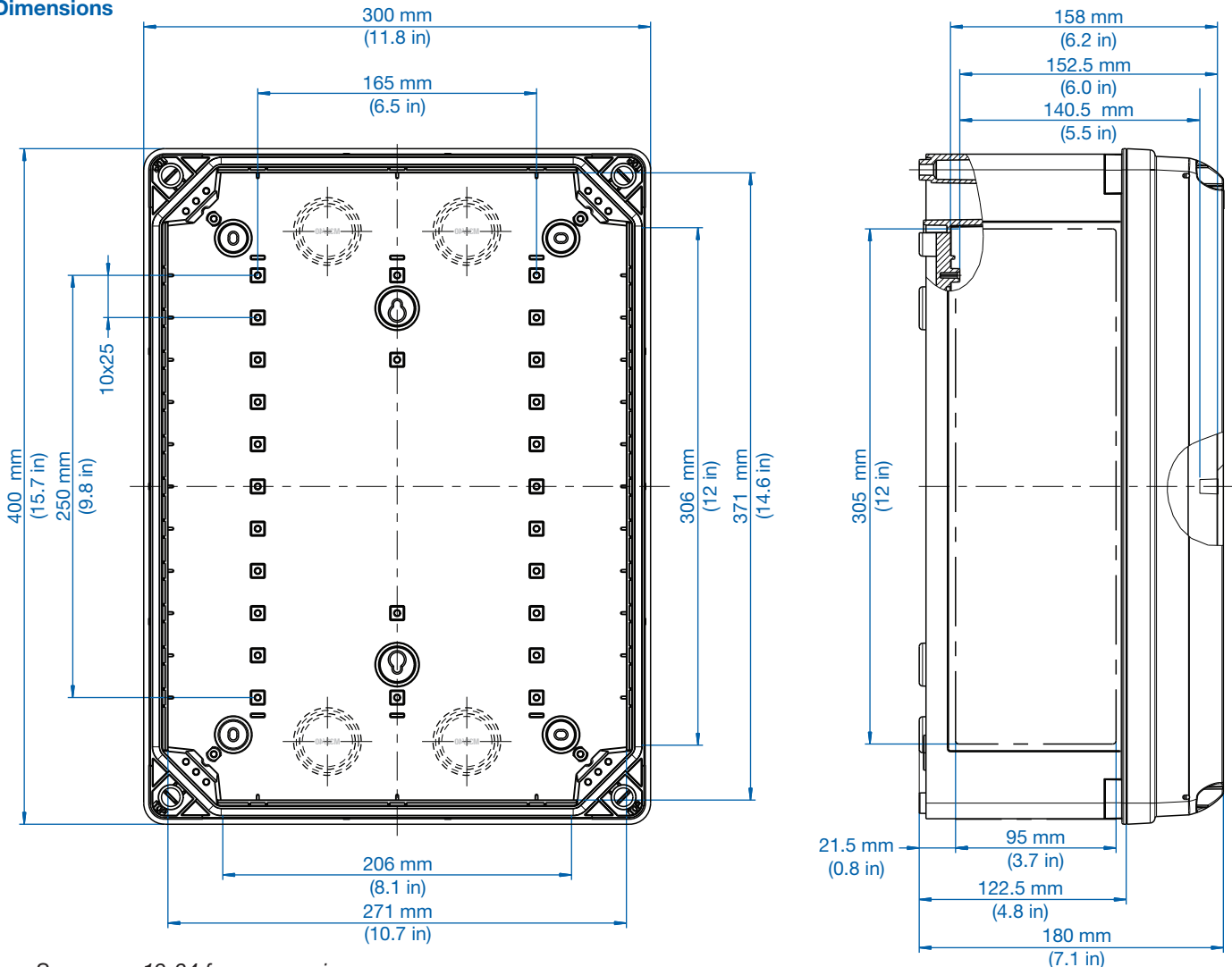

See pages 19-24 for accessories.



Cat No. 700-734
GEOS-L 3040-22-o
with grey cover

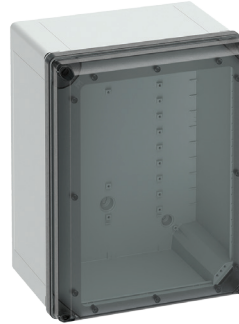

Cat No. 701-734
GEOS-L 3040-22-to
with transparent cover

Description

Empty enclosure - Industrial Quality, suitable for installation in harsh environments and in unprotected outdoor areas.
Material: glass-fiber reinforced Polycarbonate, grey, similar to RAL 7035.

Size: 300 x 400 x 226 mm

11.8 x 15.7 x 8.9 in



Dimensions

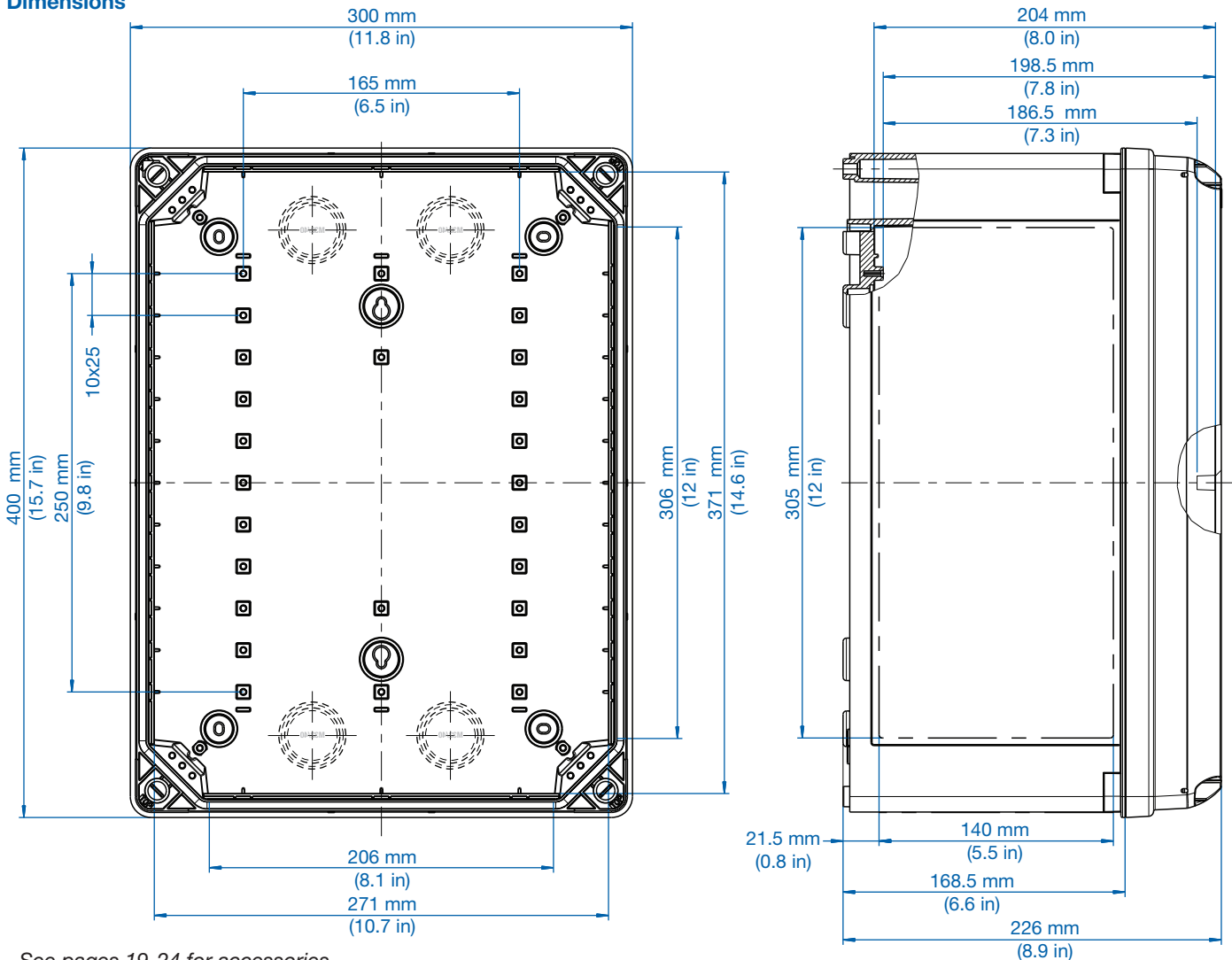

See pages 19-24 for accessories.



Cat No. 700-745
GEOS-L 4050-22-o
 with grey cover



Cat No. 701-745
GEOS-L 4050-22-to
 with transparent cover

Description

Empty enclosure - Industrial Quality, suitable for installation in harsh environments and in unprotected outdoor areas.
 Material: glass-fiber reinforced Polycarbonate, grey, similar to RAL 7035.

Size: 400 x 500 x 226 mm

15.7 x 19.7 x 8.9 in



Dimensions

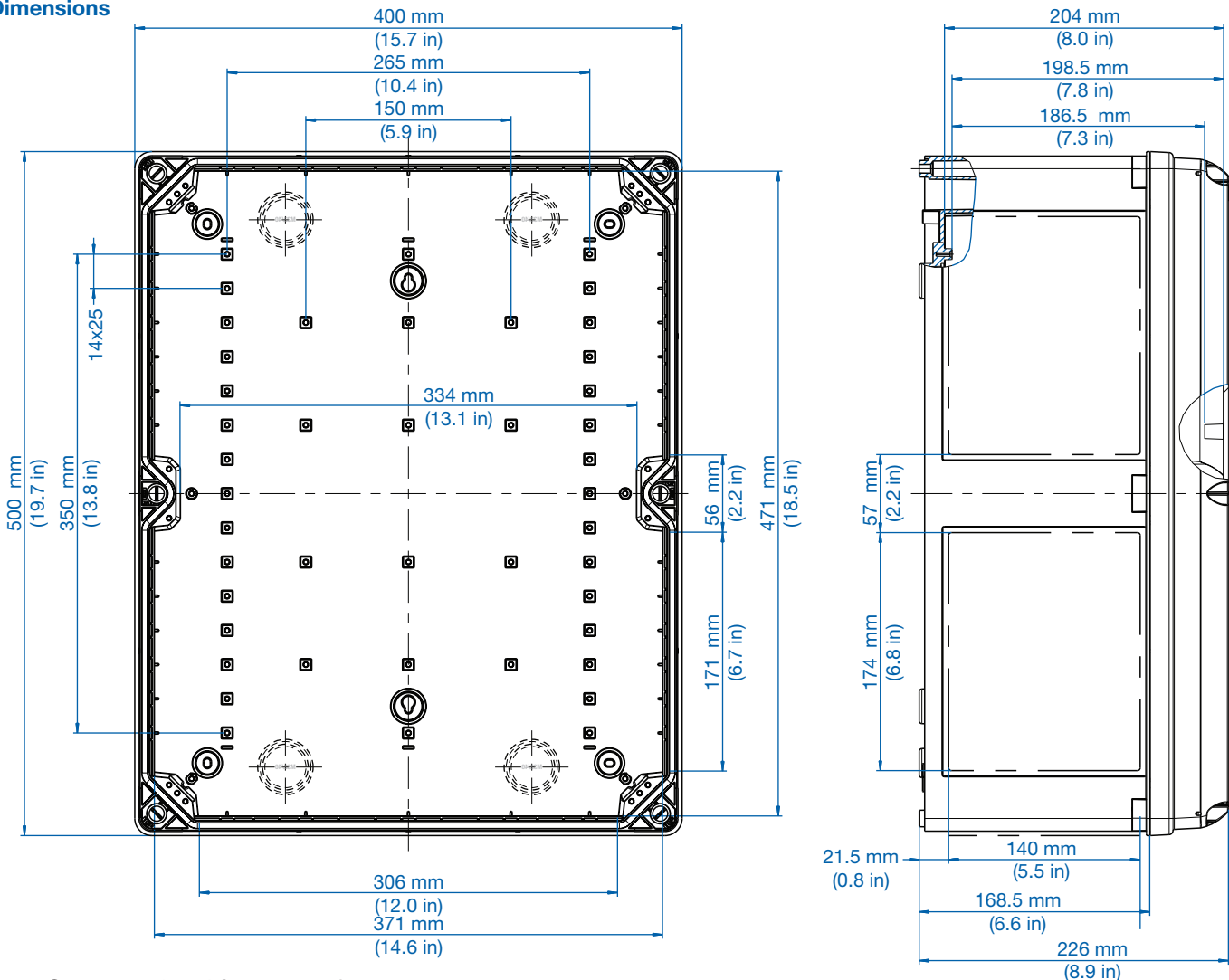

See pages 19-24 for accessories.

GEOS CABINET



Optimized for rough outdoor applications

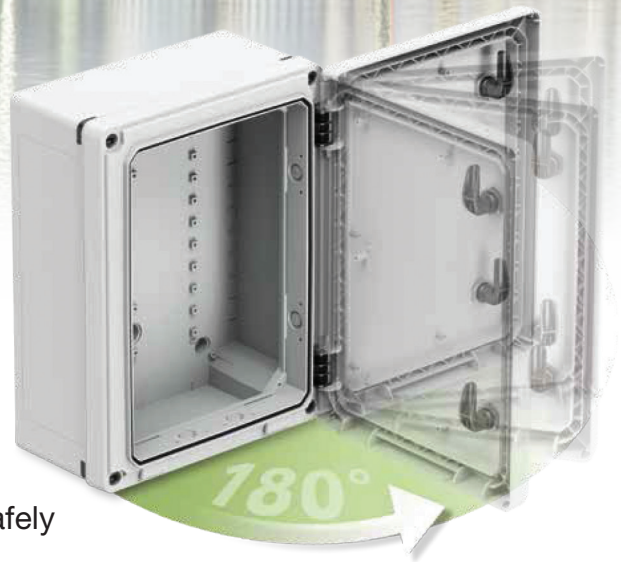
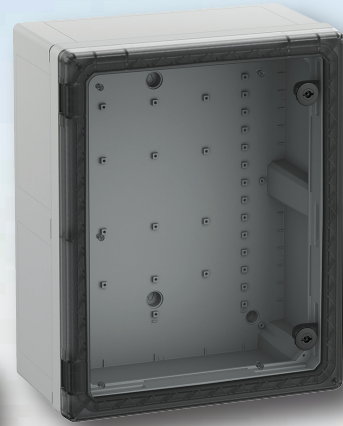

Features

- Cover frame with hinged door
- Horizontal or vertical hinge layout
- Locking system - cam lock (3mm - two bit key)
- Transparent and grey doors
- 3 base sizes
- Up to 2 enclosure heights
- Cabinets tested according to IEC 61439, IEC 62208, UL 50, UL 50E, CSA 22.2
- UL TYPE 4X rated

Advantages

- Can be opened quickly and easily and closed safely
- Good operability of components
- No restrictions for the assembly of internal fittings
- Doors with wide opening angle > 180°
- Access to the interior space with standard locking system (3 mm - two-bit key)
- Alternative locking inserts available as accessories
- Doors are guided by frames to be solid
- Doors easily removed or reversed
- Frame accepts accessories (front plates, internal swing doors, contact protection modules, door stops, wiring)



Cat No. 710-433
GEOS-S 3030-18-o
with grey cover



Cat No. 711-433
GEOS-S 3030-18-to
with transparent cover

Description

Cabinet - Industrial Quality, suitable for installation in harsh environments and in exposed outside areas, box and frame: glass-fiber reinforced Polycarbonate, grey, similar to RAL 7035, door: Polycarbonate. Door latch: cam lock with 3mm double-bit insert (interchangeable) in accordance to DIN 43668

Size: 300 x 300 x 180 mm
11.8 x 11.8 x 7.1 in



Dimensions

without door, with frame

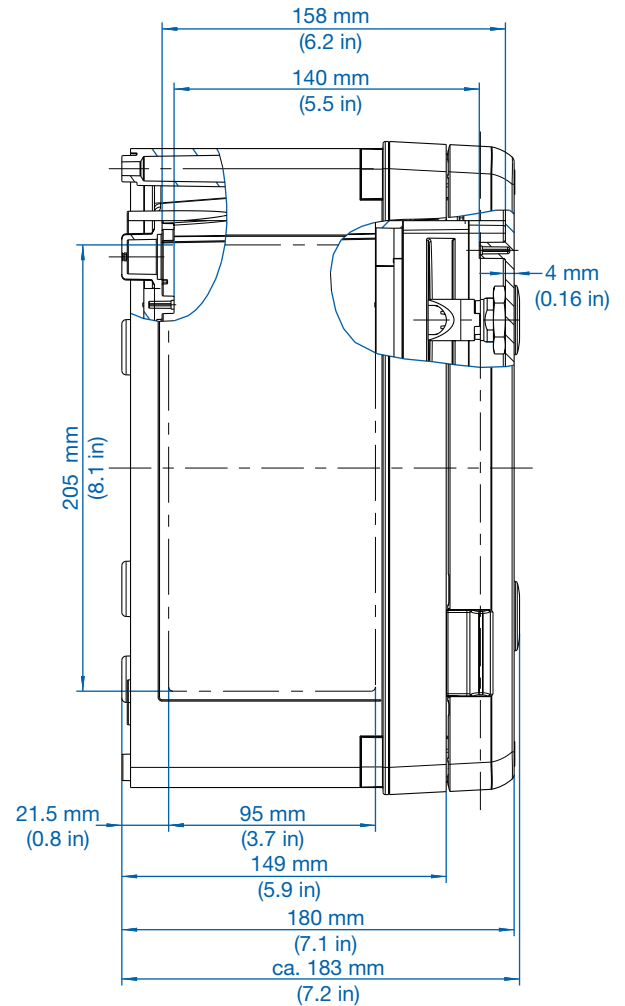
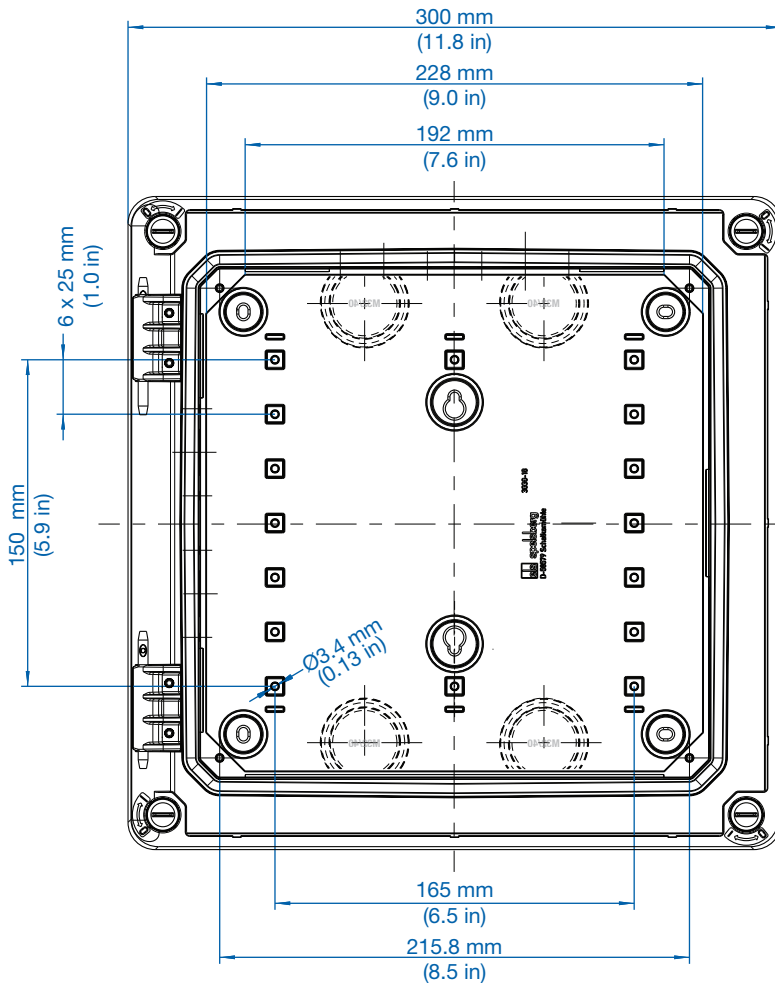

See pages 19-22 and 25-26 for accessories.



Cat No. 710-733
GEOS-S 3030-22-o
with grey cover

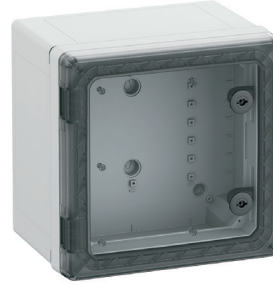

Cat No. 711-733
GEOS-S 3030-22-to
with transparent cover

Description

Cabinet - Industrial Quality, suitable for installation in harsh environments and in exposed outside areas, box and frame: glass-fiber reinforced Polycarbonate, grey, similar to RAL 7035, door: Polycarbonate. Door latch: cam lock with 3mm double-bit insert (interchangeable) in accordance to DIN 43668.

Size: 300 x 300 x 226 mm

11.8 x 11.8 x 8.9 in



Dimensions

without door, with frame

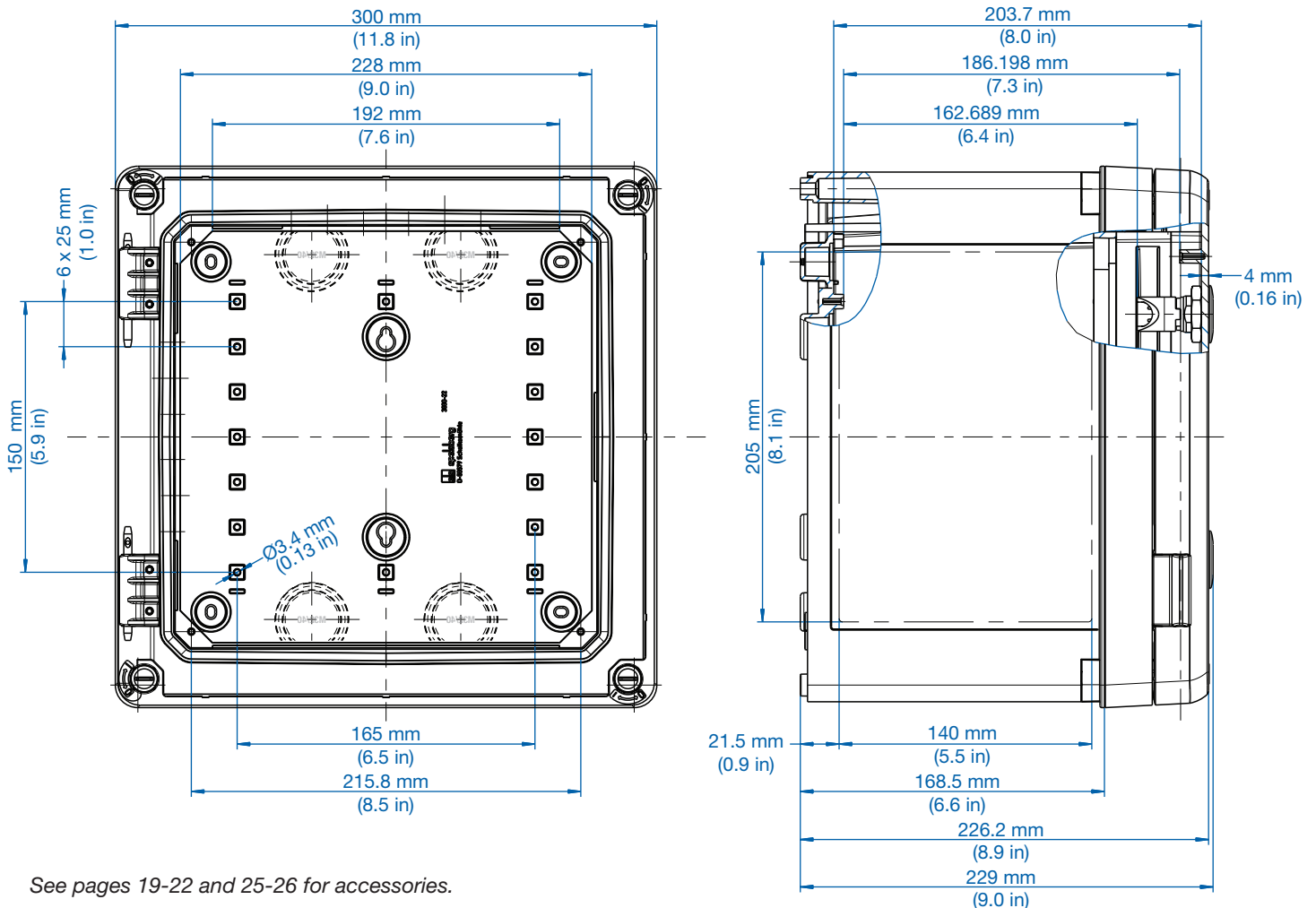

See pages 19-22 and 25-26 for accessories.



Cat No. 710-434
GEOS-S 3040-18-o
with grey cover



Cat No. 711-434
GEOS-S 3040-18-to
with transparent cover

Description

Cabinet - Industrial Quality, suitable for installation in harsh environments and in exposed outside areas, box and frame: glass-fiber reinforced Polycarbonate, grey, similar to RAL 7035, door: Polycarbonate. Door latch: cam lock with 3mm double-bit insert (interchangeable) in accordance to DIN 43668.

Size: 300 x 400 x 180 mm

11.8 x 15.7 x 7.1 in



without door, with frame

Dimensions

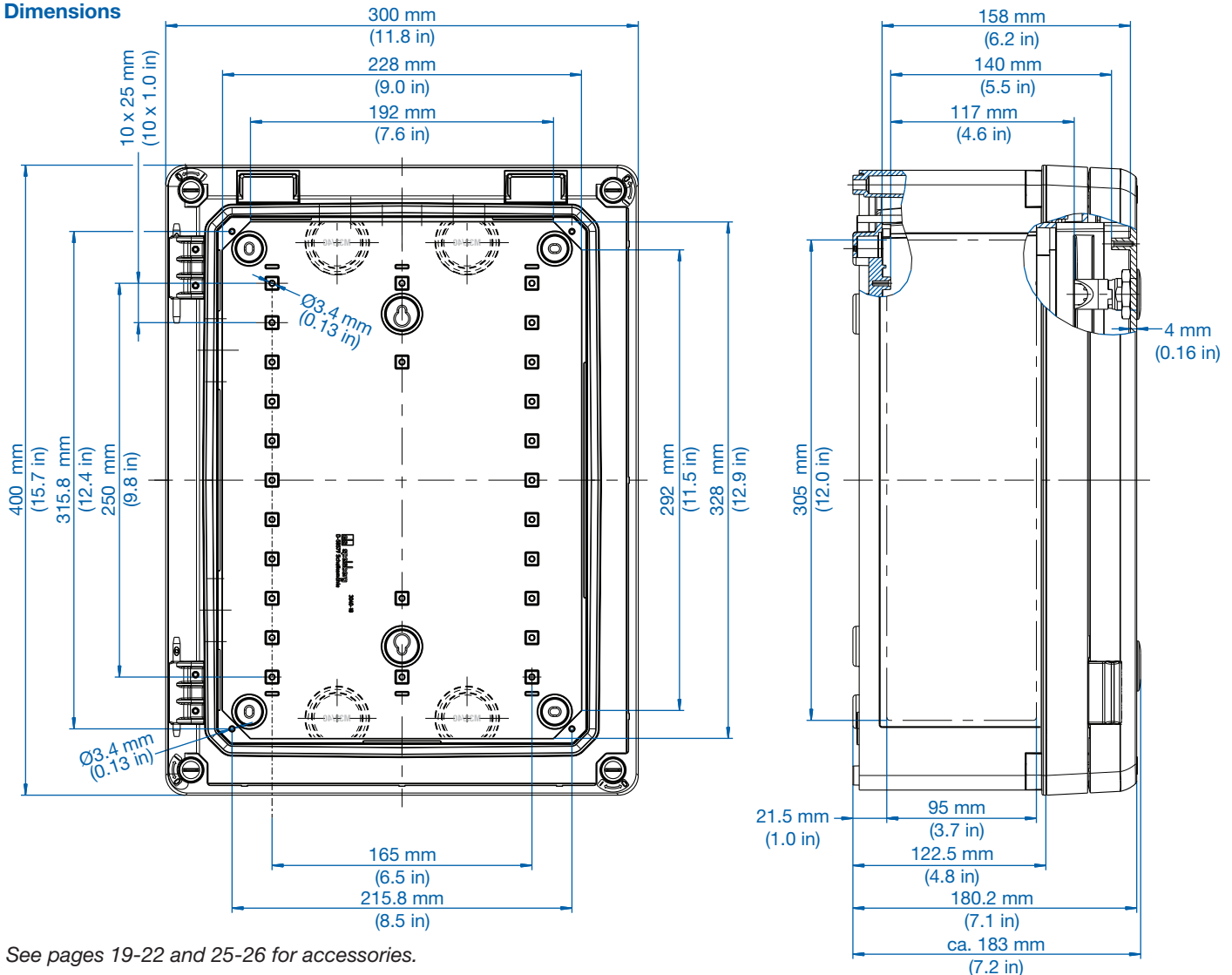

See pages 19-22 and 25-26 for accessories.



Cat No. 710-734
GEOS-S 3040-22-o
with grey cover



Cat No. 711-734
GEOS-S 3040-22-to
with transparent cover

Description

Cabinet - Industrial Quality, suitable for installation in harsh environments and in exposed outside areas, box and frame: glass-fiber reinforced Polycarbonate, grey, similar to RAL 7035, door: Polycarbonate. Door latch: cam lock with 3mm double-bit insert (interchangeable) in accordance to DIN 43668

Size: 300 x 400 x 226 mm

11.8 x 15.7 x 8.9 in



without door, with frame

Dimensions

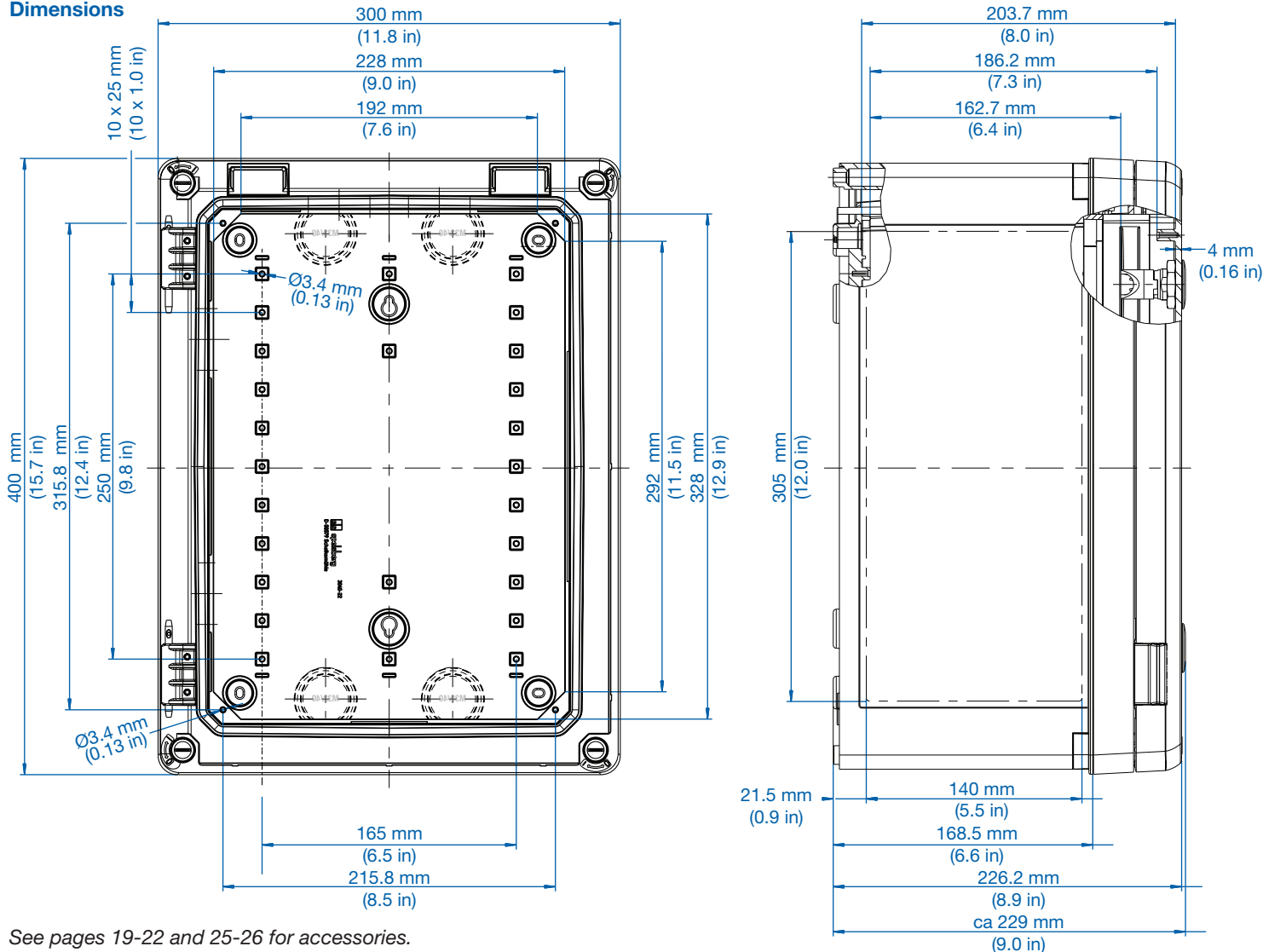

See pages 19-22 and 25-26 for accessories.



Cat No. 710-745
GEOS-S 4050-22-o
with grey cover

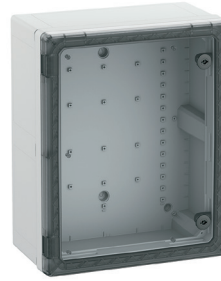

Cat No. 711-745
GEOS-S 4050-22-to
with transparent cover

Description

Cabinet - Industrial Quality, suitable for installation in harsh environments and in exposed outside areas, box and frame: glass-fiber reinforced Polycarbonate, grey, similar to RAL 7035, door: Polycarbonate. Door latch: cam lock with 3mm double-bit insert (interchangeable) in accordance to DIN 43668.



without door, with frame

Size: 400 x 500 x 226 mm

15.7 x 19.7 x 8.9 in

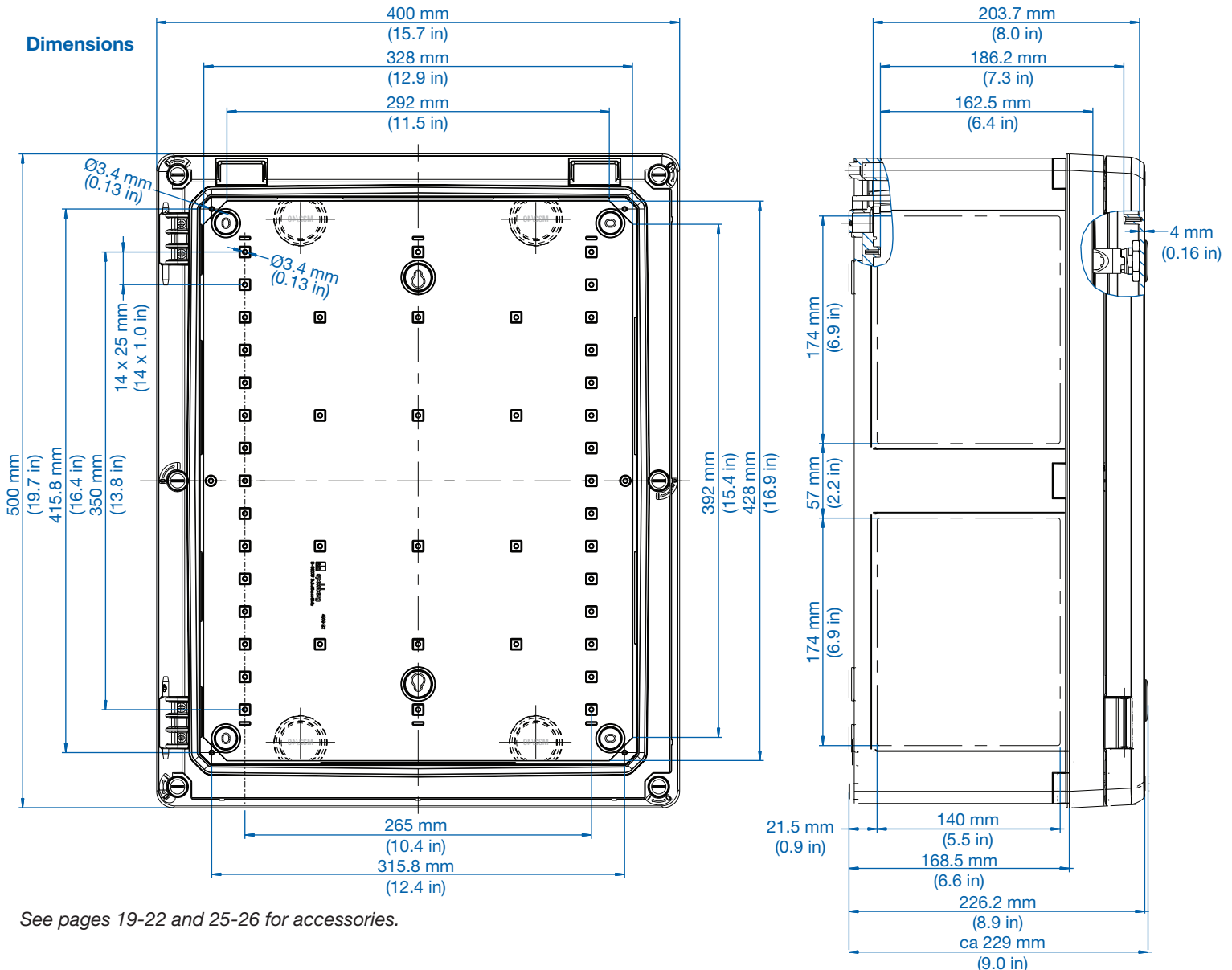

See pages 19-22 and 25-26 for accessories.

Mounting Bracket 35/7.5

Description

Mounting bracket set, for tool-free mounting of standard rails 35 x 7.5 mm and mounting plates at various heights, Set = 4 pieces.

	No. of Mounting Heights	Enclosure Type	Cat. No.
GEOS MH-18	3	GEOS-L/S 3030-18 GEOS-L/-S 3040-18 GEOS-S 4030-18	720-022
GEOS MH-22	6	GEOS-L/S 3030-22 GEOS-L/S 3040-22 GEOS-L/S 4050-22 GEOS-S 4030-22 GEOS-S 5040-22	720-023

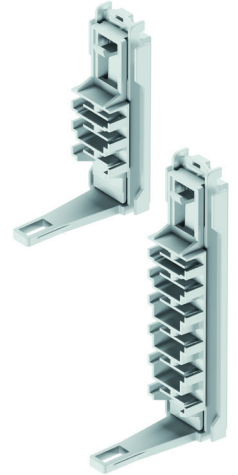

Mounting Bracket 35/15

Description

Mounting bracket set, for tool-free mounting of standard rails 35 x 15 mm and mounting plates at various heights, set = 4 pieces

	No. of Mounting Heights	Enclosure Type	Cat. No.
GEOS MH-18 NS35/15	3	GEOS-L/S 3030-18 GEOS-L/-S 3040-18 GEOS-S 4030-18	720-024
GEOS MH-22 NS35/15	6	GEOS-L/S 3030-22 GEOS-L/S 3040-22 GEOS-L/S 4050-22 GEOS-S 4030-22 GEOS-S 5040-22	720-025

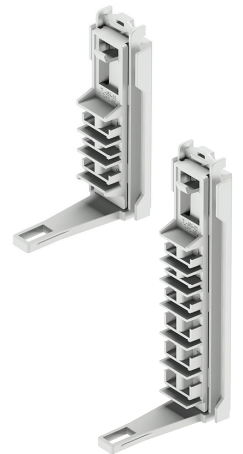

Universal Mounting Bracket

Description

Universal mounting holder set, for mounting of standard rail GEOS NS 35-200 to 400 or other items at various heights along the side of the enclosure, set = 4 pieces

	No. of Mounting Heights	Enclosure Type	Cat. No.
GEOS MHU-18	4	GEOS-L/S 3030-18 GEOS-L/S 3040-18 GEOS-S 4030-18	720-026
GEOS MHU-22	8	GEOS-L/S 3030-22 GEOS-L/S 3040-22 GEOS-L/S 4050-22 GEOS-S 4030-22 GEOS-S 5040-22	720-027



Standard Rails - 35 x 7.5 mm

Description

Standard rails according to DIN EN 60715, 35 x 7.5 mm, including fixing screws for floor mounting. Optional mounting at various heights by means of mounting bracket.



	Enclosure Side	Length	Enclosure Type	Cat. No.
GEOS NS35-250	300 mm	250 mm	GEOS-L/S 3030 GEOS-L/S 3040 GEOS-S 4030	720-031
GEOS NS35-350	400 mm	350 mm	GEOS-L/S 3040 GEOS-L/S 4050 GEOS-S 5040	720-032
GEOS NS35-450	500 mm	450 mm	GEOS-L/S 4050 GEOS-S 5040	720-033

Standard Rails - 35 x 15 mm

Description

Standard rail according to DIN EN 60715, 35 x 15 mm, including fixing screws, for floor mounting, optional mounting with mounting bracket at various heights possible



	Enclosure Side	Length	Enclosure Type	Cat. No.
GEOS NS35/15-250	300 mm	250 mm	GEOS-L/S 3030 GEOS-L/S 3040 GEOS-S 4030	720-036
GEOS NS35/15-350	400 mm	350 mm	GEOS-L/S 3040 GEOS-L/S 4050 GEOS-S 5040	720-037
GEOS NS35/15-450	500 mm	450 mm	GEOS-L/S 4050 GEOS-S 5040	720-038

Standard Rail - GEOS 4050 mid

Description

Standard rail according to DIN EN 60715, width 35 mm at heights 7.5 and 15 mm, including fastening screws, for floor-mounting in GEOS 4050 (middle position), mounting using mounting bracket in different heights not possible



	Description	Cat. No.
GEOS NS35-327	for GEOS-L/S 4050 middle position, floor mount only, length, 327mm, height, 7.5mm	720-034
GEOS NS35/15-327	for GEOS-L/S 4050 middle position, floor mount only, length, 327mm, height, 15mm	720-039

Universal Mounting Holder Standard Rail

Description

Standard rail according to DIN EN 60715, 35 x 7.5 mm, including fastening screws, for mounting on GEOS universal mounting holder MHU



	Enclosure Side	Length	Enclosure Type	Cat. No.
GEOS NS35-200	300 mm	200 mm	GEOS-L/S 3030 GEOS-L/S 3040	720-081
GEOS NS35-300	400 mm	300 mm	GEOS-L/S 3040 GEOS-L/S 4050	720-082
GEOS NS35-400	500 mm	400 mm	GEOS-L/S 4050	720-083

Carrying frame NS35

Description

Carrying frame with standard rails 35 mm, including fixing screws for floor mounting. Optional mounting by means of mounting brackets possible in various heights, non shock protection, use with contact protection covers or stand alone

	DIN Rails	Enclosure Type	Cat. No.
GEOS TGS 3040-2	2 rows 35x7.5, 12 CB units per row	GEOS-L 3040 vertical and GEOS-S 3040	720-062
GEOS TGS 4050-3	3 rows 35x7.5, 18 CB units per row	GEOS-L 4050 vertical and GEOS-S 4050	720-064
GEOS TGS 4050-2	2 rows 35x7.5 21 CB units per row	GEOS-L 4050 horizontal and GEOS-S 5040	720-065
GEOS TGS NS35/15 3040-2	2 rows 35x15 12 CB units per row	GEOS-L 3040 vertical and GEOS-S 3040	720-072
GEOS TGS NS35/15 4050-3	3 rows 35x15 18 CB units per row	GEOS-L 4050 vertical and GEOS-S 4050	720-074
GEOS TGS NS35/15 4050-2	2 rows 35x15 21 CB units per row	GEOS-L 4050 horizontal and GEOS-S 5040	720-073



Mounting Plate Insulating Material

Description

Mounting plate made from insulating material, including fixing screws for floor mounting. Optional mounting at various heights by means of mounting bracket.

	Dimensions	Enclosure Type	Cat. No.
GEOS MPI-3030	250 x 250 x 5 mm	GEOS-L/S 3030-18 and 22	720-003
GEOS MPI-3040	250 x 350 x 5 mm	GEOS-L/S 3040-18 and 22	720-004
GEOS MPI-4050	350 x 450 x 5 mm	GEOS-L/S 4050-22	720-005

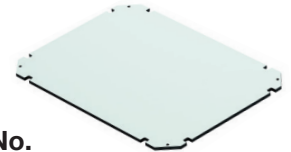

Mounting Plate Galvanized Steel

Description

Mounting plate made from galvanized steel, including fixing screws for floor mounting. Optional mounting at various heights by means of mounting bracket.

	Dimensions	Enclosure Type	Cat. No.
GEOS MPS-3030	250 x 250 x 2 mm	GEOS-L/S 3030-18 and 22	720-013
GEOS MPS-3040	250 x 350 x 2 mm	GEOS-L/S 3040-18 and 22	720-014
GEOS MPS-4050	350 x 450 x 2 mm	GEOS-L/S 4050-22	720-015

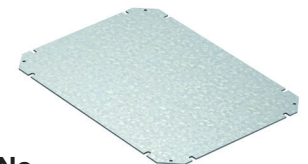

Ventilation Elements

Description

BEL Air ventilation elements set, for preventing condensate water formation in the enclosures, for vertical installation in the enclosure with appropriate knockout, at least two ventilation elements are required per enclosure. Air exchange rate: 30 l/day / Set. *UL Type 3R when using ventilation elements.*

	Cat. No.
BEL Air M40 Set = 2 pieces	263-440



External Mounting Tabs

Description

Set of external mounting tabs made of plastic, can be mounted at an angle of 0°, 45° or 90°, Color: black, Set = 4 pieces.

UL Type 12K when using external mounting tabs.



	Wall clearance	Cat. No.
GEOS ABL-10	10 mm	720-020
GEOS ABL-40	40 mm	720-021

External Mounting Bracket

Description

External mounting bracket set made of V4A stainless steel, mounting possible at an angle of 0° or 90°, set = 4 pieces

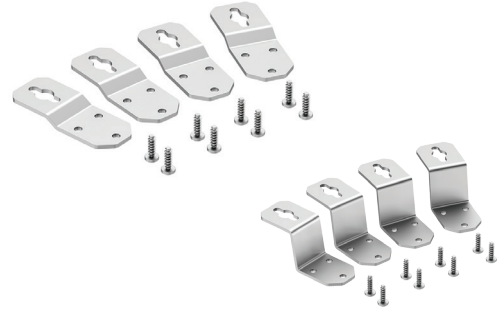

	Wall Clearance	Cat. No.
GEOS ABL-10/ES	10 mm	720-075
GEOS ABL-40/ES	40 mm	720-076

Pole Mount Kit

Description

Pole mount kit made of hot-dip galvanized steel, Set = 2 pieces.

Requires ring clamp set.

	Mounting Side	Dimensions	Cat. No.
GEOS MSS-30	300 mm	35 x 286 x 40 mm	720-050
GEOS MSS-40	400 mm	35 x 386 x 40 mm	720-051
GEOS MSS-50	500 mm	35 x 486 x 40 mm	720-052



example pole application



Ring Clamp Set

Description

Ring clamp set made of stainless steel V2A, used in conjunction with pole mount kit GEOS MSS, Set = 2 pieces.

	Pole Diameter	Cat. No.
SRS 60-90	60 to 90 mm	720-040
SRS 90-150	90 to 150 mm	720-041
SRS 150-210	150 to 210 mm	720-042



Back Cover Plate

Description

Optional plate made of V2A stainless steel to cover the back of the GEOS housing when using the GEOS MSS pole mount kit. Blocks access to rear knockouts and gives finished look to back of enclosure when mounted. Set = 1 piece.

	Enclosure Type	Dimensions	Cat. No.
GEOS DP-3030	GEOS-L/S 3030	293 x 293 x 2 mm	720-130
GEOS DP-3040	GEOS-L/S 3040	293 x 393 x 2 mm	720-131
GEOS DP-4050	GEOS-L/S 4050	393 x 493 x 2 mm	720-132



Standard Enclosure Front Mounting Plate

Description

Plate for mounting on top of enclosure base, made from insulating material, including fixing screws. Used for installing indicator and switching elements.



	Dimensions	Enclosure Type	Cat. No.
GEOS-L EP-3030	276 x 276 x 4 mm	GEOS-L 3030-18 and 22	721-013
GEOS-L EP-3040	276 x 376 x 4 mm	GEOS-L 3040-18 and 22	721-014
GEOS-L EP-4050	376 x 476 x 4 mm	GEOS-L 4050-22	721-015

Standard Enclosure Cover Plate

Description

Plate for mounting to inside of cover, made from insulating material, including fixing screws. Used for installing indicator and switching elements.



	Dimensions	Enclosure Type	Cat. No.
GEOS-L EPD-3030	276 x 276 x 4 mm	GEOS-L 3030-18 and 22	721-016
GEOS-L EPD-3040	276 x 376 x 4 mm	GEOS-L 3040-18 and 22	721-017
GEOS-L EPD-4050	376 x 476 x 4 mm	GEOS-L 4050-22	721-018

Standard Enclosure Partition Wall

Description

Partition wall made of insulating material, for dividing the enclosure, including support.

	Enclosure Side	Enclosure Type	Cat. No.
GEOS-L TW 30-18	300 mm	GEOS 3030-18	721-032
		GEOS 3040-18	
GEOS-L TW 30-22	300 mm	GEOS 3030-22	721-033
		GEOS 3040-22	
GEOS-L TW 40-18	400 mm	GEOS 3040-18	721-034
GEOS-L TW 40-22	400 mm	GEOS 3040-22	721-035
		GEOS 4050-22	
GEOS-L TW 50-22	500 mm	GEOS 4050-22	721-036



Standard Enclosure Contact Protection Cover

Description

Protective cover for rail-mounted devices, including fixing screws, for mounting in GEOS-L empty enclosure

	Description	Enclosure Type	Cat. No.
GEOS-L BSA 3030-1	1-row, 12 CB units	GEOS-L 3030-18 and 22	721-051
GEOS-L BSA 3040-1	1-row, 18 CB units	GEOS-L 3040-18 and 22	721-053
GEOS-L BSA 3040-2	2 row, 24 CB units	GEOS-L 3040-18 and 22	721-052
GEOS-L BSA 4050-2	2 row, 42 CB units	GEOS-L 4050-22	721-055
GEOS-L BSA 4050-3	3 row, 54 CB units	GEOS-L 4050-22	721-054

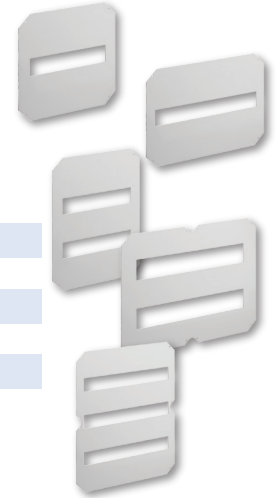

Standard Enclosure Cover Retainer

Description

Cover retainer made of stainless steel with fastening screws, mountable retroactively



	Description	Cat. No.
GEOS-L DVS	For GEOS empty enclosures, prevents cover from falling down unintentionally, set = 2 pieces	721-037

Standard Enclosure Conventional Lid Screws

Description

When conventional screws are preferred over the included 1/4 turn screws this kit can be used to replace the included set.

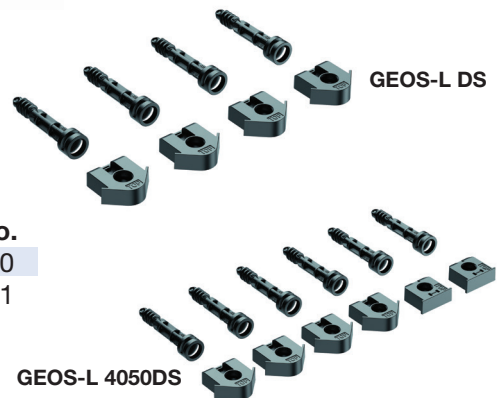

	Enclosure size	Screw Qty.	Cat. No.
GEOS-L DS	GEOS 3030/3040	4	721-040
GEOS-L 4050DS	GEOS 4050	6	721-041

Cabinet Front Plate

Description

Front plate made of insulating material for the frame of GEOS cabinets, including fixing screws, used for the installation of command and signaling devices



	Dimensions	Cabinet Type	Cat. No.
GEOS-S EPR 3030	231 x 231 x 4 mm	GEOS-S 3030-18 and 22	722-013
GEOS-S EPR 3040/4030	231 x 331 x 4 mm	GEOS-S 3040-18 and 22 GEOS-S 4030-18 and 22	722-014
GEOS-S EPR 4050/5040	231 x 431 x 4 mm	GEOS-S 4050-22 GEOS-S 5040-22	722-015

Transparent Cabinet Front Plate

Description

Front plate made of clear transparent polycarbonate for the frame of GEOS cabinets, including fixing screws, used to protect fixtures located in the cabinet while at the same time ensuring visibility



	Dimensions	Cabinet Type	Cat. No.
GEOS-S EPR-t 3030	231 x 231 x 4 mm	GEOS-S 3030-18 and 22	722-103
GEOS-S EPR-t 3040/4030	231 x 331 x 4 mm	GEOS-S 3040-18 and 22 GEOS-S 4030-18 and 22	722-104
GEOS-S EPR-t 4050/5040	231 x 431 x 4 mm	GEOS-S 4050-22 GEOS-S 5040-22	722-105

Cabinet Door Mounting Plate

Description

Mounting plate made of insulating material for the door of GEOS cabinets, including fixing screws, used for installation of indicating elements and displays



	Dimensions	Cabinet Type	Cat. No.
GEOS-S EPT 3030	150 x 225 x 4 mm	GEOS-S 3030-18 and 22	722-023
GEOS-S EPT 3040	150 x 325 x 4 mm	GEOS-S 3040-18 and 22	722-024
GEOS-S EPT 4030	250 x 225 x 4 mm	GEOS-S 4030-18 and 22	722-025
GEOS-S EPT 4050	250 x 425 x 4 mm	GEOS-S 4050-22	722-026
GEOS-S EPT 5040	175 x 325 x 4 mm	GEOS-S 5040-22	722-027

Cabinet Partition Wall

Description

Cabinet partition wall, made of insulating material, for dividing the enclosure, including support.

	Enclosure Side	Cabinet Type	Cat. No.
GEOS-S TW 30-18	300 mm	GEOS-S 3030-18, GEOS-S 3040-18, GEOS-S 4030-18	722-032
GEOS-S TW 30-22	300 mm	GEOS-S 3030-22, GEOS-S 3040-22, GEOS-S 4030-22	722-033
GEOS-S TW 40-18	400 mm	GEOS-S 3040-18, GEOS-S 4030-18	722-034
GEOS-S TW 40-22	400 mm	GEOS-S 3040-22, GEOS-S 4030-22, GEOS-S 4050-22, GEOS-S 5040-22	722-035
GEOS-S TW 50-22	500 mm	GEOS-S 4050-22, GEOS-S 5040-22	722-036

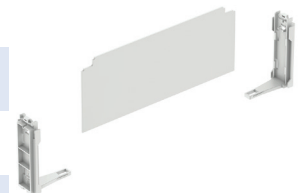

Cabinet Door Stop

Description

Door stop for securing the open cabinet door in two possible positions



	Cabinet Type	Cat. No.
GEOS-S TFS	all GEOS-S cabinets	722-070