

**Model 72950
SMA PLUG STRAIGHT CRIMP, REVERSE POLARITY,
RG174, 188, 316**

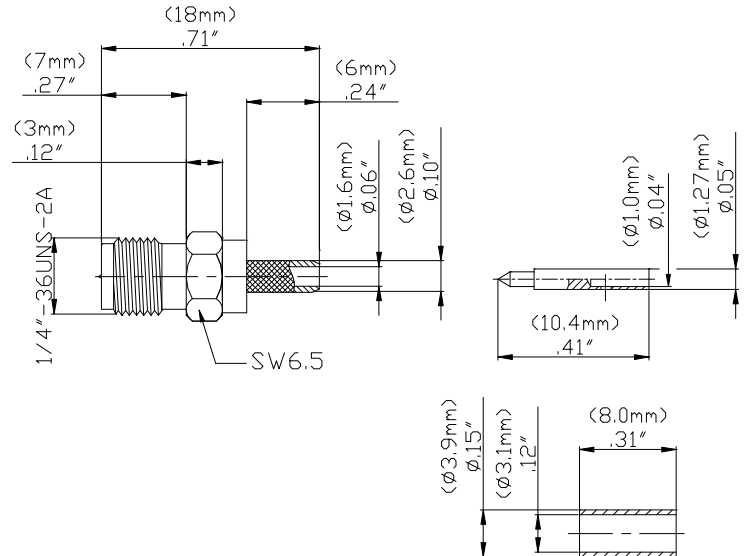
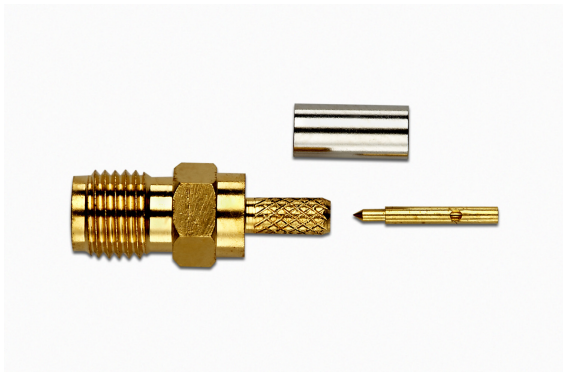

Model 72950 SMA PLUG STRAIGHT CRIMP, REVERSE POLARITY, RG174, 188, 316

High bandwidth, small size, and durability for confident connections

Features

- DC – 4 GHz bandwidth.
- Meets MIL-C-39012, IEC 169-15, CECC 22110.
- Small size and durability for mobile communications.
- Precision machined and gold-plated for low loss.

Materials

- Body is machined brass with gold plating.
- Center Contacts - Plug is gold plated brass and Jack is gold plated Beryllium copper.
- Insulators are high quality PTFE.
- Crimp Ferrules are copper with gold or nickel plating.
- Gaskets are silicone rubber.

Specifications

Impedance	50 Ω
Frequency Range	DC – 4 GHz
Working Voltage	< 375 V _{peak}
Dielectric Withstanding Voltage	1,000 V _{rms}
VSWR	1.35 max.
Center/Outer Contact Resistance	0.003/0.002 Ω max
Insulation resistance	> 5000 MΩ
Number of Insertions	500 cycles minimum
Temperature Range	-65° C to 165° C, -85° F to 329° F

Ordering Information

Model: 72950
Description: SMA PLUG STRAIGHT CRIMP, REVERSE POLARITY, RG174, 188, 316

USA: Sales: 800-490-2361
Technical Support: technicalsupport@pomonatest.com
Fax: 425-446-5844

Europe: 31-(0) 40 2675 150 International: 425-446-5500

Where to Buy: www.pomonaelectronics.com

All dimensions are in inches. Tolerances (except noted): .xx = ±.02" (.51 mm), .xxx = ± .005" (.127 mm). All specifications are to the latest revisions. Specifications are subject to change without notice. Registered trademarks are the property of their respective companies.
D2003388 REV 001

**Model 72950
SMA PLUG STRAIGHT CRIMP, REVERSE POLARITY,
RG174, 188, 316**

Cable Types and Crimp Die Information

Connector Model #	Cable Groups	Crimp Die Cavity Size for Outer Ferrule
72950	RG174, 188, 316	.128 (3.3)

Cable Assembly Instructions

1. CUT CABLE END EVENLY AND PERPENDICULAR



2. SLIDE OUTER FERRULE OVER CABLE END.

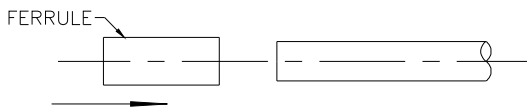

3. STRIP CABLE JACKET, BRAID, AND DIELECTRIC TO SPECIFICATION LENGTHS.

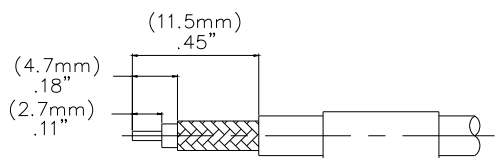

RECOMMENDED STRIP LENGTHS FOR MODEL 7035

4. INSERT CONTACT PIN ONTO CABLE'S CENTER CONDUCTOR SO THAT IT IS FLUSH TO DIELECTRIC, CRIMP OR SOLDER CONTACT FIRMLY.

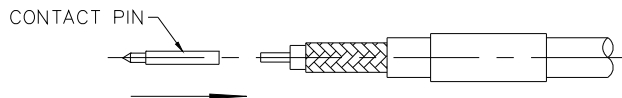

5. FLARE BRAID END SLIGHTLY.

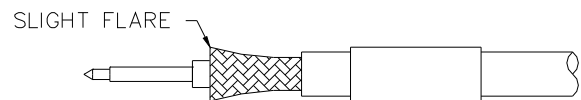

6. INSERT CENTER CONTACT OVER CABLE CENTER CONDUCTOR FLUSH UNTIL FLUSH WITH DIELECTRIC.

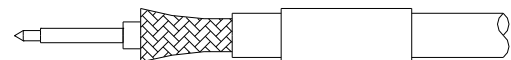

7. SLIDE CONNECTOR BODY OVER CENTER CONTACT AND SLIDE OUTER FERRULE OVER BRAID AND UP AGAINST BODY ASSEMBLY.

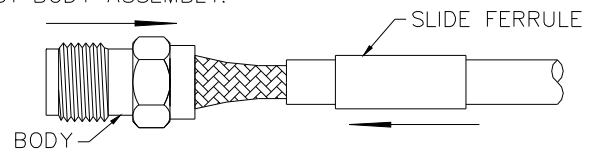

8. CRIMP OUTER FERRULE WITH APPROPRIATE CRIMP TOOL.

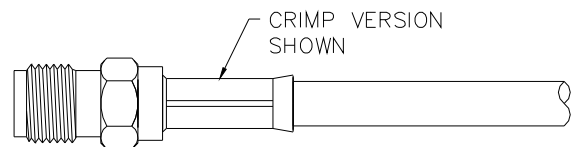

USA: Sales: 800-490-2361
 Technical Support: technicalsupport@pomonatest.com
 Fax: 425-446-5844
Europe: 31-(0) 40 2675 150 **International:** 425-446-5500
Where to Buy: www.pomonaelectronics.com

All dimensions are in inches. Tolerances (except noted): .xx = ±.02" (.51 mm), .xxx = ±.005" (.127 mm). All specifications are to the latest revisions. Specifications are subject to change without notice. Registered trademarks are the property of their respective companies.
 D2003388 REV 001