

MATERIALS AND FINISHES

BODY BRASS
PLATED GOLD

CENTER CONTACT BERYLLIUM COPPER
PLATED GOLD

INSULATOR TEFLON

O-RING SILICONE RUBBER

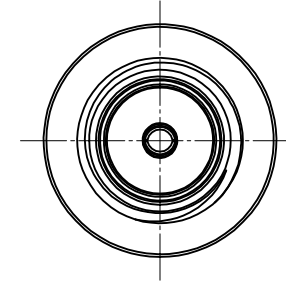
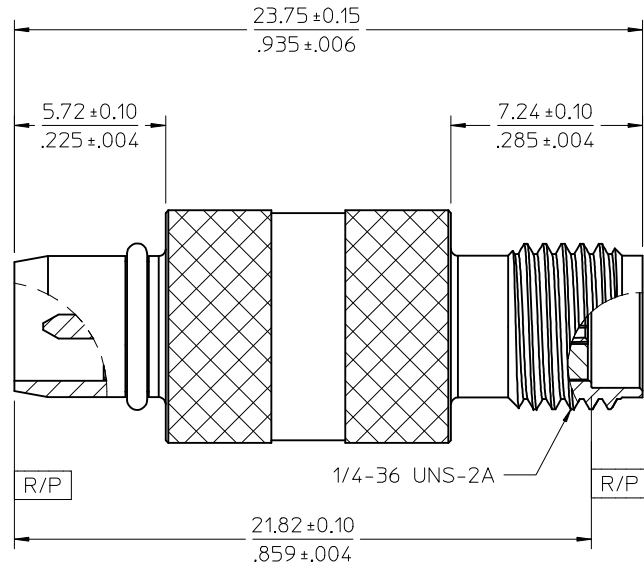
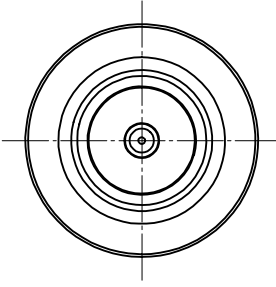
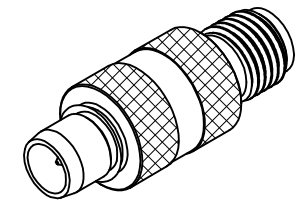

73386-5260	TRAY
PART NO.	PACKAGING

MIL-STD-348A, FIG. 321.1	INTERFACE BMA
MIL-STD-348A, FIG. 310.2	INTERFACE SMA
SPECIFICATION	DESCRIPTION

CHG:NEW RELEASE PER PDR1411784	EC NO: URF2015-0304	DRW:RYEH	CHKD: 2014/11/26	APPR:YCHENG	2014/12/24
REV	DESCRIPTION	QUALITY SYMBOLS			
A		▽=0			
		▽=0			
		▽=0			

GENERAL TOLERANCES (UNLESS SPECIFIED)	
mm	INCH
4 PLACES ± .005	± .0004
3 PLACES ± .004	± .0003
2 PLACES ± .003	± .0002
1 PLACE ± .002	± .0001
0 PLACE ± .001	± .0000
ANGULAR ± 2 °	
DRAFT WHERE APPLICABLE MUST REMAIN WITHIN DIMENSIONS	

DIMENSION STYLE	
MM/IN	
DRAWN BY	DATE
RYEH	2014/11/24
CHECKED BY	DATE
KERRIE	2014/11/24
APPROVED BY	DATE
YCHENG	2014/12/24
MATERIAL NO.	
SEE TABLE	
SIZE	C

SCALE	DESIGN UNITS	THIRD ANGLE PROJECTION
7:1	METRIC	☉
TITLE		
BSA BMA PLUG TO SMA JACK		
IN-LINE 50 OHMS		
BSA-BMAP/SMAJ		
molex		
DOCUMENT NO.	SHEET NO.	
SD-73386-526	1 OF 1	
THIS DRAWING CONTAINS INFORMATION THAT IS PROPRIETARY TO MOLEX INCORPORATED AND SHOULD NOT BE USED WITHOUT WRITTEN PERMISSION		