

# 74AHC1G04-Q100; 74AHCT1G04-Q100

## Inverter

Rev. 1 — 20 November 2013

Product data sheet

## 1. General description

74AHC1G04-Q100 and 74AHCT1G04-Q100 are high-speed Si-gate CMOS devices. They provide an inverting buffer.

The AHC device has CMOS input switching levels and supply voltage range 2 V to 5.5 V.

The AHCT device has TTL input switching levels and supply voltage range 4.5 V to 5.5 V.

This product has been qualified to the Automotive Electronics Council (AEC) standard Q100 (Grade 1) and is suitable for use in automotive applications.

## 2. Features and benefits

- Automotive product qualification in accordance with AEC-Q100 (Grade 1)
  - ◆ Specified from  $-40\text{ }^{\circ}\text{C}$  to  $+85\text{ }^{\circ}\text{C}$  and from  $-40\text{ }^{\circ}\text{C}$  to  $+125\text{ }^{\circ}\text{C}$
- Symmetrical output impedance
- High noise immunity
- Low power dissipation
- Balanced propagation delays
- SOT353-1 and SOT753 package options
- ESD protection:
  - ◆ MIL-STD-883, method 3015 exceeds 2000 V
  - ◆ HBM JESD22-A114F exceeds 2000 V
  - ◆ MM JESD22-A115-A exceeds 200 V (C = 200 pf, R = 0  $\Omega$ )

## 3. Ordering information

Table 1. Ordering information

| Type number                           | Package   |        |   |          |
|---------------------------------------|---|--------|---|----------|
|                                       | Temperature range   | Name   | Description   | Version  |
| 74AHC1G04GW-Q100<br>74AHCT1G04GW-Q100 | $-40\text{ }^{\circ}\text{C}$ to $+125\text{ }^{\circ}\text{C}$ | TSSOP5 | plastic thin shrink small outline package;<br>5 leads; body width 1.25 mm | SOT353-1 |
| 74AHC1G04GV-Q100<br>74AHCT1G04GV-Q100 | $-40\text{ }^{\circ}\text{C}$ to $+125\text{ }^{\circ}\text{C}$ | SC-74A | plastic surface-mounted package; 5 leads                                  | SOT753   |

## 4. Marking

Table 2. Marking codes

| Type number       | Marking <sup>[1]</sup> |
|-------------------|------------------------|
| 74AHC1G04GW-Q100  | AC                     |
| 74AHC1G04GV-Q100  | A04                    |
| 74AHCT1G04GW-Q100 | CC                     |
| 74AHCT1G04GV-Q100 | C04                    |

[1] The pin 1 indicator is located on the lower left corner of the device, below the marking code.

## 5. Functional diagram

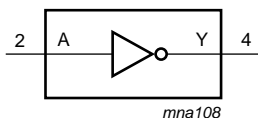

Fig 1. Logic symbol



Fig 2. IEC logic symbol

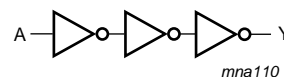

Fig 3. Logic diagram

## 6. Pinning information

### 6.1 Pinning

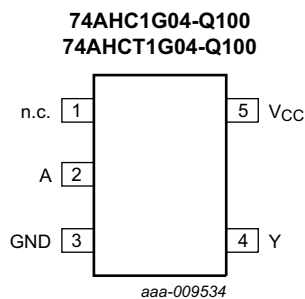

Fig 4. Pin configuration

### 6.2 Pin description

Table 3. Pin description

| Symbol          | Pin | Description    |
|-----------------|-----|----------------|
| n.c.            | 1   | not connected  |
| A               | 2   | data input     |
| GND             | 3   | ground (0 V)   |
| Y               | 4   | data output    |
| V <sub>CC</sub> | 5   | supply voltage |

## 7. Functional description

**Table 4. Function table**

*H = HIGH voltage level; L = LOW voltage level*

| Input | Output |
|-------|--------|
| A     | Y      |
| L     | H      |
| H     | L      |

## 8. Limiting values

**Table 5. Limiting values**

*In accordance with the Absolute Maximum Rating System (IEC 60134).*

| Symbol    | Parameter               | Conditions                               | Min   | Max  | Unit |
|-----------|-------------------------|--|-------|------|------|
| $V_{CC}$  | supply voltage          |  | -0.5  | +7.0 | V    |
| $V_I$     | input voltage           |  | -0.5  | +7.0 | V    |
| $I_{IK}$  | input clamping current  | $V_I < -0.5$ V                           | -20   | -    | mA   |
| $I_{OK}$  | output clamping current | $V_O < -0.5$ V or $V_O > V_{CC} + 0.5$ V | [1] - | ±20  | mA   |
| $I_O$     | output current          | $-0.5$ V < $V_O$ < $V_{CC} + 0.5$ V      | -     | ±25  | mA   |
| $I_{CC}$  | supply current          |  | -     | 75   | mA   |
| $I_{GND}$ | ground current          |  | -75   | -    | mA   |
| $T_{stg}$ | storage temperature     |  | -65   | +150 | °C   |
| $P_{tot}$ | total power dissipation | $T_{amb} = -40$ °C to +125 °C            | [2] - | 250  | mW   |

[1] The input and output voltage ratings may be exceeded if the input and output current ratings are observed.

[2] For both TSSOP5 and SC-74A packages: above 87.5 °C the value of  $P_{tot}$  derates linearly with 4.0 mW/K.

## 9. Recommended operating conditions

**Table 6. Recommended operating conditions**

*Voltages are referenced to GND (ground = 0 V).*

| Symbol              | Parameter                           | Conditions               | 74AHC1G04-Q100 |     |          | 74AHCT1G04-Q100 |     |          | Unit |
|---------------------|-------------------------------------|--------------------------|----------------|-----|----------|-----------------|-----|----------|------|
|                     |                                     |                          | Min            | Typ | Max      | Min             | Typ | Max      |      |
| $V_{CC}$            | supply voltage                      |                          | 2.0            | 5.0 | 5.5      | 4.5             | 5.0 | 5.5      | V    |
| $V_I$               | input voltage                       |                          | 0              | -   | 5.5      | 0               | -   | 5.5      | V    |
| $V_O$               | output voltage                      |                          | 0              | -   | $V_{CC}$ | 0               | -   | $V_{CC}$ | V    |
| $T_{amb}$           | ambient temperature                 |                          | -40            | +25 | +125     | -40             | +25 | +125     | °C   |
| $\Delta t/\Delta V$ | input transition rise and fall rate | $V_{CC} = 3.3$ V ± 0.3 V | -              | -   | 100      | -               | -   | -        | ns/V |
|                     |                                     | $V_{CC} = 5.0$ V ± 0.5 V | -              | -   | 20       | -               | -   | 20       | ns/V |

## 10. Static characteristics

**Table 7. Static characteristics**

Voltages are referenced to GND (ground = 0 V).

| Symbol  | Parameter                 | Conditions  | 25 °C |     |      | -40 °C to +85 °C |      | -40 °C to +125 °C |      | Unit |
|---|---------------------------|---|-------|-----|------|------------------|------|-------------------|------|------|
|   |                           |   | Min   | Typ | Max  | Min              | Max  | Min               | Max  |      |
| <b>For type 74AHC1G04-Q100</b>                    |                           |   |       |     |      |                  |      |                   |      |      |
| V <sub>IH</sub>                                   | HIGH-level input voltage  | V <sub>CC</sub> = 2.0 V   | 1.5   | -   | -    | 1.5              | -    | 1.5               | -    | V    |
|   |                           | V <sub>CC</sub> = 3.0 V   | 2.1   | -   | -    | 2.1              | -    | 2.1               | -    | V    |
|   |                           | V <sub>CC</sub> = 5.5 V   | 3.85  | -   | -    | 3.85             | -    | 3.85              | -    | V    |
| V <sub>IL</sub>                                   | LOW-level input voltage   | V <sub>CC</sub> = 2.0 V   | -     | -   | 0.5  | -                | 0.5  | -                 | 0.5  | V    |
|   |                           | V <sub>CC</sub> = 3.0 V   | -     | -   | 0.9  | -                | 0.9  | -                 | 0.9  | V    |
|   |                           | V <sub>CC</sub> = 5.5 V   | -     | -   | 1.65 | -                | 1.65 | -                 | 1.65 | V    |
| V <sub>OH</sub>                                   | HIGH-level output voltage | V <sub>I</sub> = V <sub>IH</sub> or V <sub>IL</sub>                                       |       |     |      |                  |      |                   |      |      |
|   |                           | I <sub>O</sub> = -50 μA; V <sub>CC</sub> = 2.0 V  | 1.9   | 2.0 | -    | 1.9              | -    | 1.9               | -    | V    |
|   |                           | I <sub>O</sub> = -50 μA; V <sub>CC</sub> = 3.0 V  | 2.9   | 3.0 | -    | 2.9              | -    | 2.9               | -    | V    |
|   |                           | I <sub>O</sub> = -50 μA; V <sub>CC</sub> = 4.5 V  | 4.4   | 4.5 | -    | 4.4              | -    | 4.4               | -    | V    |
|   |                           | I <sub>O</sub> = -4.0 mA; V <sub>CC</sub> = 3.0 V   | 2.58  | -   | -    | 2.48             | -    | 2.40              | -    | V    |
| I <sub>O</sub> = -8.0 mA; V <sub>CC</sub> = 4.5 V | 3.94                      | -   | -     | 3.8 | -    | 3.70             | -    | V                 |      |      |
| V <sub>OL</sub>                                   | LOW-level output voltage  | V <sub>I</sub> = V <sub>IH</sub> or V <sub>IL</sub>                                       |       |     |      |                  |      |                   |      |      |
|   |                           | I <sub>O</sub> = 50 μA; V <sub>CC</sub> = 2.0 V   | -     | 0   | 0.1  | -                | 0.1  | -                 | 0.1  | V    |
|   |                           | I <sub>O</sub> = 50 μA; V <sub>CC</sub> = 3.0 V   | -     | 0   | 0.1  | -                | 0.1  | -                 | 0.1  | V    |
|   |                           | I <sub>O</sub> = 50 μA; V <sub>CC</sub> = 4.5 V   | -     | 0   | 0.1  | -                | 0.1  | -                 | 0.1  | V    |
|   |                           | I <sub>O</sub> = 4.0 mA; V <sub>CC</sub> = 3.0 V  | -     | -   | 0.36 | -                | 0.44 | -                 | 0.55 | V    |
| I <sub>O</sub> = 8.0 mA; V <sub>CC</sub> = 4.5 V  | -                         | -   | 0.36  | -   | 0.44 | -                | 0.55 | V                 |      |      |
| I <sub>I</sub>                                    | input leakage current     | V <sub>I</sub> = 5.5 V or GND;<br>V <sub>CC</sub> = 0 V to 5.5 V                          | -     | -   | 0.1  | -                | 1.0  | -                 | 2.0  | μA   |
| I <sub>CC</sub>                                   | supply current            | V <sub>I</sub> = V <sub>CC</sub> or GND; I <sub>O</sub> = 0 A;<br>V <sub>CC</sub> = 5.5 V | -     | -   | 1.0  | -                | 10   | -                 | 40   | μA   |
| C <sub>I</sub>                                    | input capacitance         |   | -     | 1.5 | 10   | -                | 10   | -                 | 10   | pF   |
| <b>For type 74AHCT1G04-Q100</b>                   |                           |   |       |     |      |                  |      |                   |      |      |
| V <sub>IH</sub>                                   | HIGH-level input voltage  | V <sub>CC</sub> = 4.5 V to 5.5 V  | 2.0   | -   | -    | 2.0              | -    | 2.0               | -    | V    |
| V <sub>IL</sub>                                   | LOW-level input voltage   | V <sub>CC</sub> = 4.5 V to 5.5 V  | -     | -   | 0.8  | -                | 0.8  | -                 | 0.8  | V    |
| V <sub>OH</sub>                                   | HIGH-level output voltage | V <sub>I</sub> = V <sub>IH</sub> or V <sub>IL</sub> ; V <sub>CC</sub> = 4.5 V             |       |     |      |                  |      |                   |      |      |
|   |                           | I <sub>O</sub> = -50 μA   | 4.4   | 4.5 | -    | 4.4              | -    | 4.4               | -    | V    |
|   |                           | I <sub>O</sub> = -8.0 mA  | 3.94  | -   | -    | 3.8              | -    | 3.70              | -    | V    |
| V <sub>OL</sub>                                   | LOW-level output voltage  | V <sub>I</sub> = V <sub>IH</sub> or V <sub>IL</sub> ; V <sub>CC</sub> = 4.5 V             |       |     |      |                  |      |                   |      |      |
|   |                           | I <sub>O</sub> = 50 μA  | -     | 0   | 0.1  | -                | 0.1  | -                 | 0.1  | V    |
|   |                           | I <sub>O</sub> = 8.0 mA   | -     | -   | 0.36 | -                | 0.44 | -                 | 0.55 | V    |
| I <sub>I</sub>                                    | input leakage current     | V <sub>I</sub> = 5.5 V or GND;<br>V <sub>CC</sub> = 0 V to 5.5 V                          | -     | -   | 0.1  | -                | 1.0  | -                 | 2.0  | μA   |

**Table 7. Static characteristics ...continued**  
 Voltages are referenced to GND (ground = 0 V).

| Symbol          | Parameter                 | Conditions   | 25 °C |     |      | -40 °C to +85 °C |     | -40 °C to +125 °C |     | Unit    |
|-----------------|---------------------------|--|-------|-----|------|------------------|-----|-------------------|-----|---------|
|                 |                           |  | Min   | Typ | Max  | Min              | Max | Min               | Max |         |
| $I_{CC}$        | supply current            | $V_I = V_{CC}$ or GND; $I_O = 0$ A;<br>$V_{CC} = 5.5$ V  | -     | -   | 1.0  | -                | 10  | -                 | 40  | $\mu$ A |
| $\Delta I_{CC}$ | additional supply current | per input pin; $V_I = 3.4$ V;<br>other inputs at $V_{CC}$ or GND;<br>$I_O = 0$ A; $V_{CC} = 5.5$ V | -     | -   | 1.35 | -                | 1.5 | -                 | 1.5 | mA      |
| $C_I$           | input capacitance         |  | -     | 1.5 | 10   | -                | 10  | -                 | 10  | pF      |

## 11. Dynamic characteristics

**Table 8. Dynamic characteristics**  
 $GND = 0$  V;  $t_r = t_f = \leq 3.0$  ns; for test circuit, see [Figure 6](#).

| Symbol | Parameter | Conditions | 25 °C |     |     | -40 °C to +85 °C |     | -40 °C to +125 °C |     | Unit |
|--------|-----------|------------|-------|-----|-----|------------------|-----|-------------------|-----|------|
|        |           |            | Min   | Typ | Max | Min              | Max | Min               | Max |      |

### For type 74AHC1G04-Q100

|          |                               |  |   |     |      |     |     |     |      |    |
|----------|-------------------------------|--|---|-----|------|-----|-----|-----|------|----|
| $t_{pd}$ | propagation delay             | A to Y; see <a href="#">Figure 5</a> <a href="#">[1]</a>                   |   |     |      |     |     |     |      |    |
|          |                               | $V_{CC} = 3.0$ V to 3.6 V <a href="#">[2]</a>                              |   |     |      |     |     |     |      |    |
|          |                               | $C_L = 15$ pF  | - | 4.3 | 7.1  | 1.0 | 8.5 | 1.0 | 11.0 | ns |
|          |                               | $C_L = 50$ pF  | - | 6.1 | 10.6 | 1.0 | 12  | 1.0 | 14.5 | ns |
|          |                               | $V_{CC} = 4.5$ V to 5.5 V <a href="#">[3]</a>                              |   |     |      |     |     |     |      |    |
|          |                               | $C_L = 15$ pF  | - | 3.1 | 5.5  | 1.0 | 6.5 | 1.0 | 7.0  | ns |
| $C_{PD}$ | power dissipation capacitance | $C_L = 50$ pF; $f = 1$ MHz;<br>$V_I = GND$ to $V_{CC}$ <a href="#">[4]</a> | - | 15  | -    | -   | -   | -   | -    | pF |
|          |                               | $C_L = 50$ pF  | - | 4.5 | 7.5  | 1.0 | 8.5 | 1.0 | 9.5  | ns |

### For type 74AHCT1G04-Q100

|          |                               |  |   |     |     |     |     |     |      |    |
|----------|-------------------------------|--|---|-----|-----|-----|-----|-----|------|----|
| $t_{pd}$ | propagation delay             | A to Y; see <a href="#">Figure 5</a> <a href="#">[1]</a>                   |   |     |     |     |     |     |      |    |
|          |                               | $V_{CC} = 4.5$ V to 5.5 V <a href="#">[3]</a>                              |   |     |     |     |     |     |      |    |
|          |                               | $C_L = 15$ pF  | - | 3.4 | 6.7 | 1.0 | 7.5 | 1.0 | 8.5  | ns |
| $C_{PD}$ | power dissipation capacitance | $C_L = 50$ pF; $f = 1$ MHz;<br>$V_I = GND$ to $V_{CC}$ <a href="#">[4]</a> | - | 16  | -   | -   | -   | -   | -    | pF |
|          |                               | $C_L = 50$ pF  | - | 4.9 | 7.7 | 1.0 | 8.5 | 1.0 | 10.0 | ns |

[1]  $t_{pd}$  is the same as  $t_{PLH}$  and  $t_{PHL}$ .

[2] Typical values are measured at  $V_{CC} = 3.3$  V.

[3] Typical values are measured at  $V_{CC} = 5.0$  V.

[4]  $C_{PD}$  is used to determine the dynamic power dissipation  $P_D$  ( $\mu$ W).

$$P_D = C_{PD} \times V_{CC}^2 \times f_i + \sum (C_L \times V_{CC}^2 \times f_o) \text{ where:}$$

$f_i$  = input frequency in MHz;  $f_o$  = output frequency in MHz;

$C_L$  = output load capacitance in pF;

$V_{CC}$  = supply voltage in Volts;

$N$  = total load switching outputs;

$\sum(C_L \times V_{CC}^2 \times f_o)$  = sum of outputs.

## 12. Waveforms

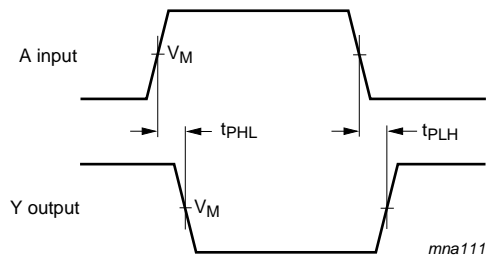

Measurement points are given in [Table 9](#).

**Fig 5. Input (A) to output (Y) propagation delays**

**Table 9. Measurement point**

| Type            | Input           | Input               | Output              |
|-----------------|-----------------|---------------------|---------------------|
|                 | $V_I$           | $V_M$               | $V_M$               |
| 74AHC1G04-Q100  | GND to $V_{CC}$ | $0.5 \times V_{CC}$ | $0.5 \times V_{CC}$ |
| 74AHCT1G04-Q100 | GND to 3.0 V    | 1.5 V               | $0.5 \times V_{CC}$ |

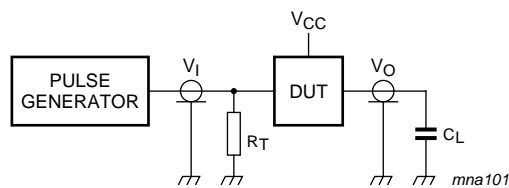

Test data is given in [Table 8](#). Definitions for test circuit:

$C_L$  = Load capacitance including jig and probe capacitance.

$R_T$  = Termination resistance should be equal to output impedance  $Z_o$  of the pulse generator.

**Fig 6. Load circuitry for switching times**

13. Package outline

TSSOP5: plastic thin shrink small outline package; 5 leads; body width 1.25 mm

SOT353-1

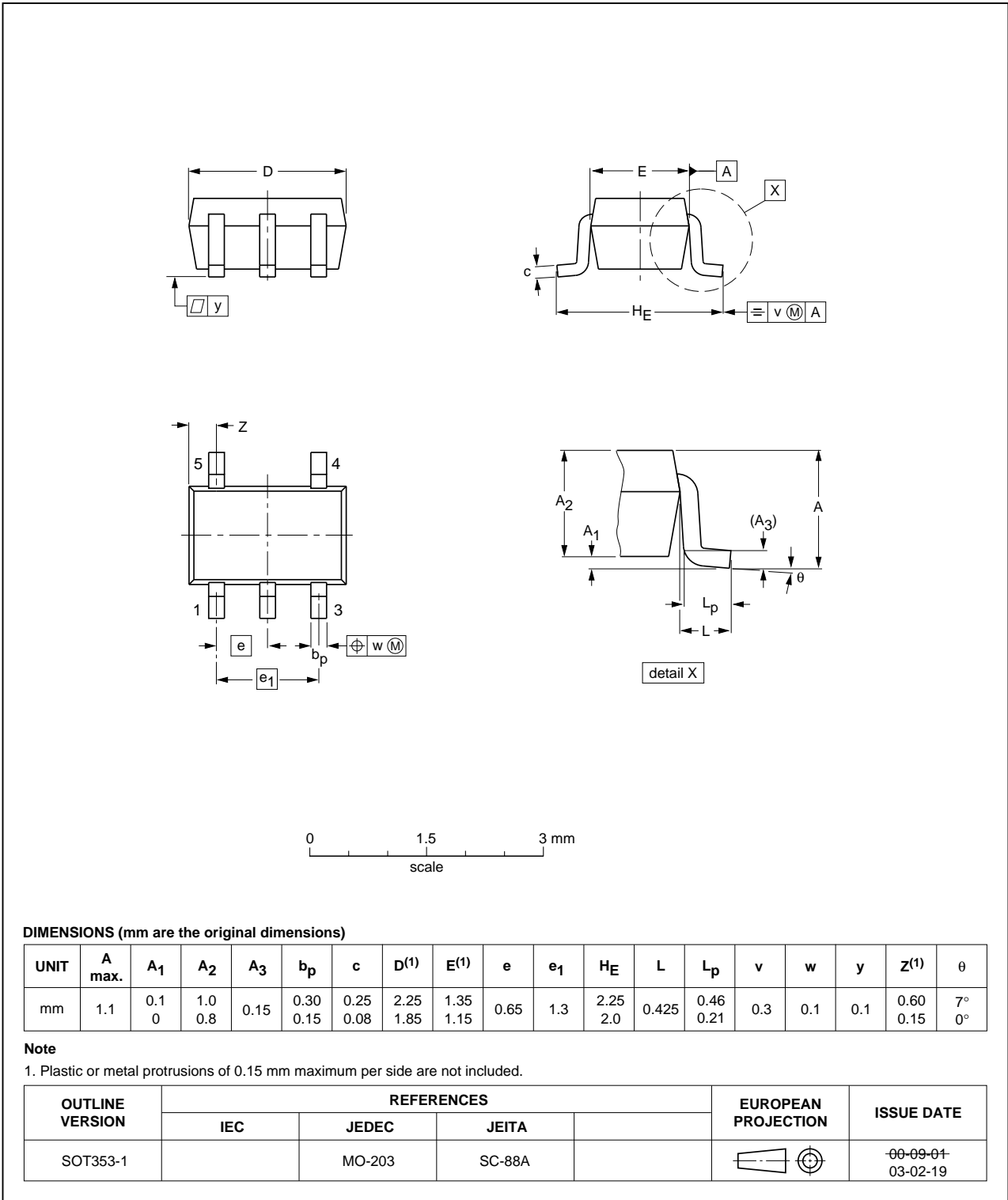

Fig 7. Package outline SOT353-1 (TSSOP5)

Plastic surface-mounted package; 5 leads

SOT753

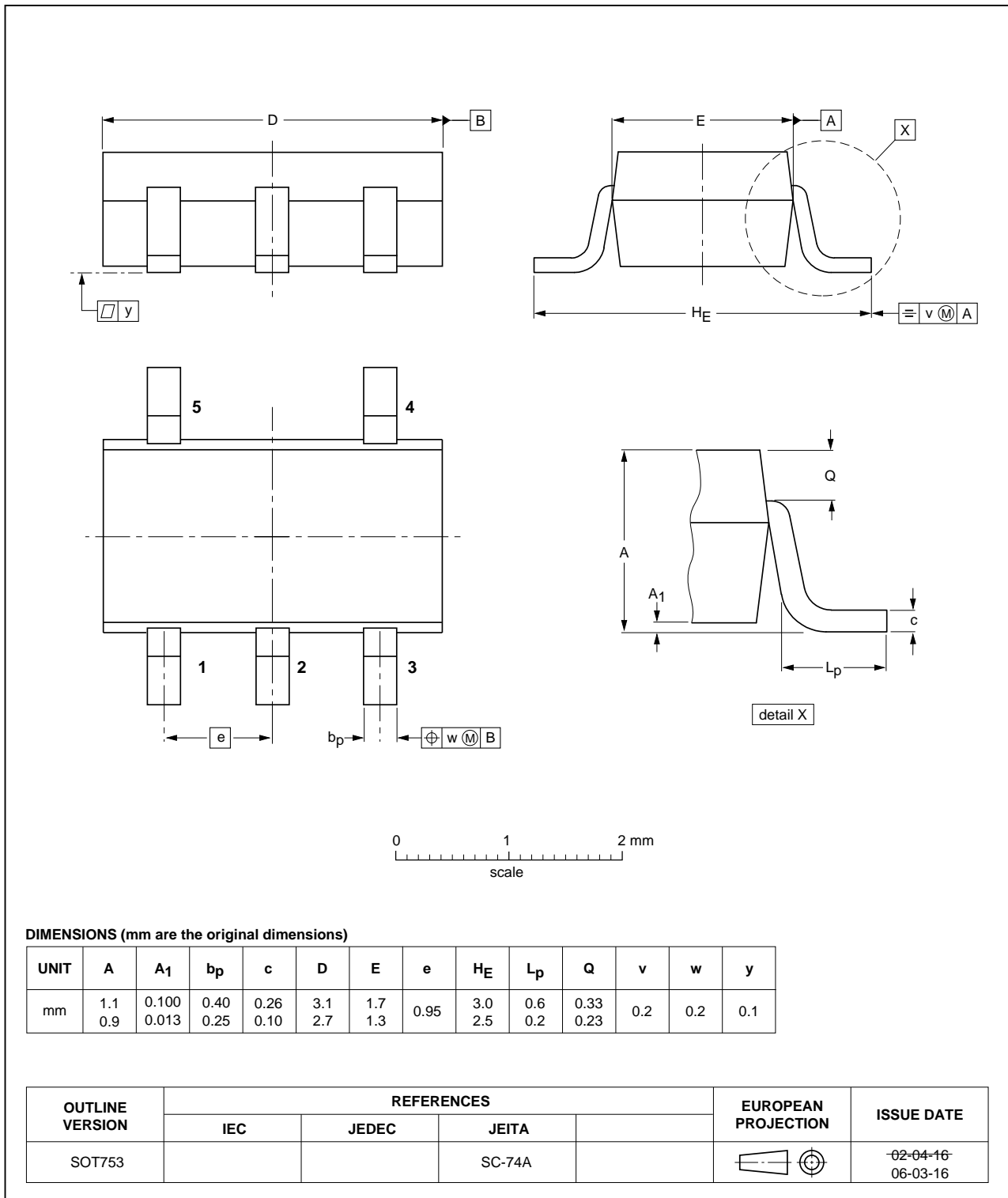

Fig 8. Package outline SOT753 (SC-74A)



## 14. Abbreviations

Table 10. Abbreviations

| Acronym | Description                 |
|---------|-----------------------------|
| CDM     | Charged Device Model        |
| DUT     | Device Under Test           |
| ESD     | ElectroStatic Discharge     |
| HBM     | Human Body Model            |
| MIL     | Military                    |
| MM      | Machine Model               |
| TTL     | Transistor-Transistor Logic |

## 15. Revision history

Table 11. Revision history

| Document ID             | Release date | Data sheet status  | Change notice | Supersedes |
|-------------------------|--------------|--------------------|---------------|------------|
| 74AHC_AHCT1G04_Q100 v.1 | 20131120     | Product data sheet | -             | -          |

## 16. Legal information

### 16.1 Data sheet status

| Document status <sup>[1][2]</sup> | Product status <sup>[3]</sup> | Definition  |
|-----------------------------------|-------------------------------|---|
| Objective [short] data sheet      | Development                   | This document contains data from the objective specification for product development. |
| Preliminary [short] data sheet    | Qualification                 | This document contains data from the preliminary specification.                       |
| Product [short] data sheet        | Production                    | This document contains the product specification.                                     |

[1] Please consult the most recently issued document before initiating or completing a design.

[2] The term 'short data sheet' is explained in section "Definitions".

[3] The product status of device(s) described in this document may have changed since this document was published and may differ in case of multiple devices. The latest product status information is available on the Internet at URL <http://www.nexperia.com>.

### 16.2 Definitions

**Draft** — The document is a draft version only. The content is still under internal review and subject to formal approval, which may result in modifications or additions. Nexperia does not give any representations or warranties as to the accuracy or completeness of information included herein and shall have no liability for the consequences of use of such information.

**Short data sheet** — A short data sheet is an extract from a full data sheet with the same product type number(s) and title. A short data sheet is intended for quick reference only and should not be relied upon to contain detailed and full information. For detailed and full information see the relevant full data sheet, which is available on request via the local Nexperia sales office. In case of any inconsistency or conflict with the short data sheet, the full data sheet shall prevail.

**Product specification** — The information and data provided in a Product data sheet shall define the specification of the product as agreed between Nexperia and its customer, unless Nexperia and customer have explicitly agreed otherwise in writing. In no event however, shall an agreement be valid in which the Nexperia product is deemed to offer functions and qualities beyond those described in the Product data sheet.

### 16.3 Disclaimers

**Limited warranty and liability** — Information in this document is believed to be accurate and reliable. However, Nexperia does not give any representations or warranties, expressed or implied, as to the accuracy or completeness of such information and shall have no liability for the consequences of use of such information. Nexperia takes no responsibility for the content in this document if provided by an information source outside of Nexperia.

In no event shall Nexperia be liable for any indirect, incidental, punitive, special or consequential damages (including - without limitation - lost profits, lost savings, business interruption, costs related to the removal or replacement of any products or rework charges) whether or not such damages are based on tort (including negligence), warranty, breach of contract or any other legal theory.

Notwithstanding any damages that customer might incur for any reason whatsoever, Nexperia's aggregate and cumulative liability towards customer for the products described herein shall be limited in accordance with the *Terms and conditions of commercial sale* of Nexperia.

**Right to make changes** — Nexperia reserves the right to make changes to information published in this document, including without limitation specifications and product descriptions, at any time and without notice. This document supersedes and replaces all information supplied prior to the publication hereof.

**Suitability for use in automotive applications** — This Nexperia product has been qualified for use in automotive applications. Unless otherwise agreed in writing, the product is not designed, authorized or warranted to be suitable for use in life support, life-critical or safety-critical systems or equipment, nor in applications where failure or malfunction of a Nexperia product can reasonably be expected to result in personal injury, death or severe property or environmental damage. Nexperia and its suppliers accept no liability for inclusion and/or use of Nexperia products in such equipment or applications and therefore such inclusion and/or use is at the customer's own risk.

**Applications** — Applications that are described herein for any of these products are for illustrative purposes only. Nexperia makes no representation or warranty that such applications will be suitable for the specified use without further testing or modification.

Customers are responsible for the design and operation of their applications and products using Nexperia products, and Nexperia accepts no liability for any assistance with applications or customer product design. It is customer's sole responsibility to determine whether the Nexperia product is suitable and fit for the customer's applications and products planned, as well as for the planned application and use of customer's third party customer(s). Customers should provide appropriate design and operating safeguards to minimize the risks associated with their applications and products.

Nexperia does not accept any liability related to any default, damage, costs or problem which is based on any weakness or default in the customer's applications or products, or the application or use by customer's third party customer(s). Customer is responsible for doing all necessary testing for the customer's applications and products using Nexperia products in order to avoid a default of the applications and the products or of the application or use by customer's third party customer(s). Nexperia does not accept any liability in this respect.

**Limiting values** — Stress above one or more limiting values (as defined in the Absolute Maximum Ratings System of IEC 60134) will cause permanent damage to the device. Limiting values are stress ratings only and (proper) operation of the device at these or any other conditions above those given in the Recommended operating conditions section (if present) or the Characteristics sections of this document is not warranted. Constant or repeated exposure to limiting values will permanently and irreversibly affect the quality and reliability of the device.

**Terms and conditions of commercial sale** — Nexperia products are sold subject to the general terms and conditions of commercial sale, as published at <http://www.nexperia.com/profile/terms>, unless otherwise agreed in a valid written individual agreement. In case an individual agreement is concluded only the terms and conditions of the respective agreement shall apply. Nexperia hereby expressly objects to applying the customer's general terms and conditions with regard to the purchase of Nexperia products by customer.

**No offer to sell or license** — Nothing in this document may be interpreted or construed as an offer to sell products that is open for acceptance or the grant, conveyance or implication of any license under any copyrights, patents or other industrial or intellectual property rights.

**Export control** — This document as well as the item(s) described herein may be subject to export control regulations. Export might require a prior authorization from competent authorities.

**Translations** — A non-English (translated) version of a document is for reference only. The English version shall prevail in case of any discrepancy between the translated and English versions.

## 16.4 Trademarks

Notice: All referenced brands, product names, service names and trademarks are the property of their respective owners.

## 17. Contact information

---

For more information, please visit: <http://www.nexperia.com>

For sales office addresses, please send an email to: [salesaddresses@nexperia.com](mailto:salesaddresses@nexperia.com)