

Description

The 74FCT3807S is a low skew, single input to ten output, clock buffer. The 74FCT3807S has best in class additive phase Jitter of sub 50 fsec.

IDT makes many non-PLL and PLL based low skew output devices as well as Zero Delay Buffers to synchronize clocks. Contact us for all of your clocking needs.

Features

- Low additive phase jitter RMS: 50fs
- Low skew outputs (50ps)
- Packaged in 20-pin TSSOP, SSOP, QSOP and VFQFPN packages, Pb (lead) free
- Operating voltages of 1.8V to 3.3V
- Input/Output clock frequency up to 200 MHz
- Advanced, low power CMOS process
- Extended temperature range (-40°C to +105°C)

Block Diagram

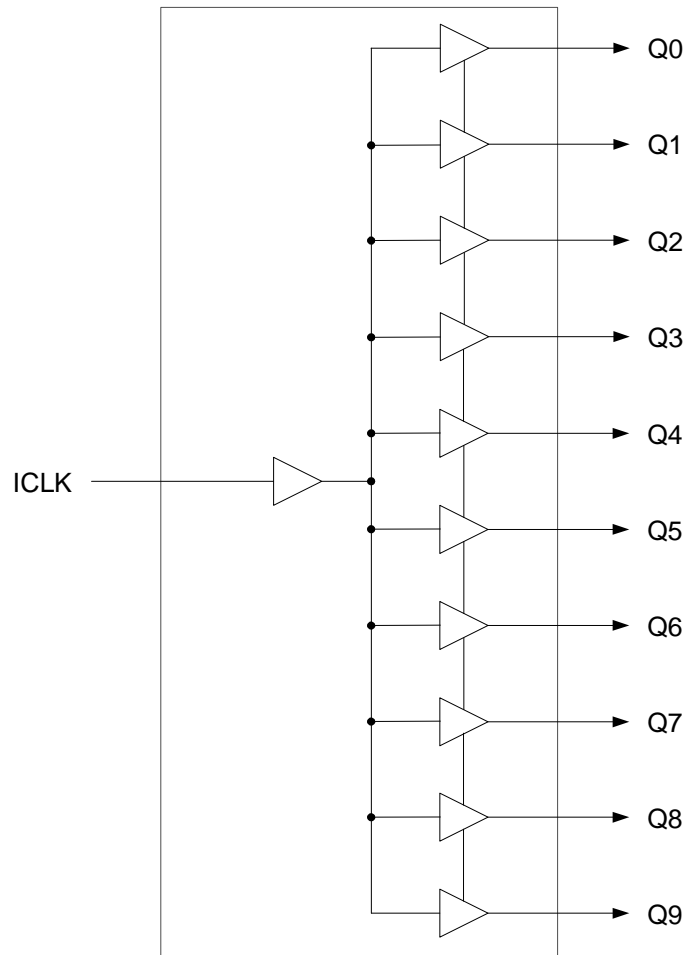

Pin Assignments

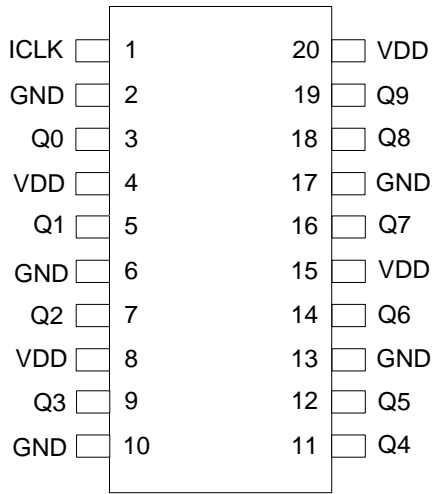

20-pin TSSOP/SSOP/QSOP

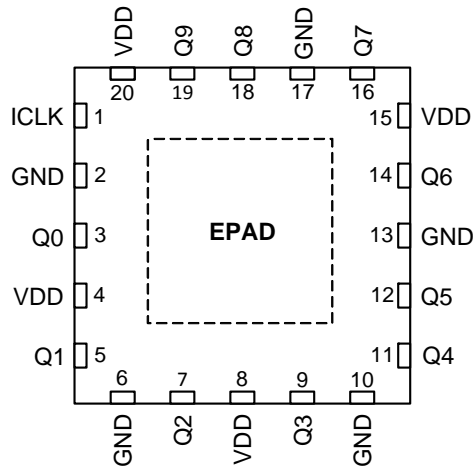

20-pin VFQFPN

Pin Descriptions

Pin Number	Pin Name	Pin Type	Pin Description
1	ICLK	Input	Clock input.
2	GND	Power	Connect to ground.
3	Q0	Output	Clock output 0.
4	VDD	Power	Connect to +1.8V, +2.5 V, or +3.3 V.
5	Q1	Output	Clock output 1.
6	GND	Power	Connect to ground.
7	Q2	Output	Clock Output 2.
8	VDD	Power	Connect to +1.8V, +2.5 V, or +3.3 V.
9	Q3	Output	Clock Output 3.
10	GND	Power	Connect to ground.
11	Q4	Output	Clock Output 4.
12	Q5	Output	Clock Output 5.
13	GND	Power	Connect to ground.
14	Q6	Output	Clock Output 6.
15	VDD	Power	Connect to +1.8V, +2.5 V, or +3.3 V.
16	Q7	Output	Clock Output 7.
17	GND	Power	Connect to ground.
18	Q8	Output	Clock Output 8.
19	Q9	Output	Clock Output 9.
20	VDD	Power	Connect to +1.8V, +2.5 V, or +3.3 V.

External Components

A minimum number of external components are required for proper operation. A decoupling capacitor of 0.01 μ F should be connected between VDD pins and GND pins, as close to the device as possible. A 33 Ω series terminating resistor may be used on each clock output if the trace is longer than 1 inch.

To achieve the low output skew that the 74FCT3807S is capable of, careful attention must be paid to board layout. Essentially, all ten outputs must have identical terminations, identical loads and identical trace geometries. If they do not, the output skew will be degraded. For example, using a 30 Ω series termination on one output (with 33 Ω on the others) will cause at least 15 ps of skew.

Absolute Maximum Ratings

Stresses above the ratings listed below can cause permanent damage to the 74FCT3807S. These ratings, which are standard values for IDT commercially rated parts, are stress ratings only. Functional operation of the device at these or any other conditions above those indicated in the operational sections of the specifications is not implied. Exposure to absolute maximum rating conditions for extended periods can affect product reliability. Electrical parameters are guaranteed only over the recommended operating temperature range.

Item	Rating
Supply Voltage, VDD	3.465V
Outputs	-0.5 V to VDD+0.5 V
ICLK	3.465V
Ambient Operating Temperature (extended)	-40° to +105°C
Storage Temperature	-65° to +150°C
Junction Temperature	125°C
Soldering Temperature	260°C

Recommended Operation Conditions

Parameter	Min.	Typ.	Max.	Units
Ambient Operating Temperature (extended)	-40		+105	°C
Power Supply Voltage (measured in respect to GND)	+1.71		+3.465	V

DC Electrical Characteristics

(VDD = 1.8V, 2.5V, 3.3V)

VDD=1.8V ±5% , Ambient temperature -40° to +105°C, unless stated otherwise

Parameter	Symbol	Conditions	Min.	Typ.	Max.	Units
Operating Voltage	VDD		1.71		1.89	V
Input High Voltage, ICLK	V _{IH}	Note 1	0.7xVDD		VDD	V
Input Low Voltage, ICLK	V _{IL}	Note 1			0.3xVDD	V
Output High Voltage	V _{OH}	I _{OH} = -10 mA	1.3			V
Output Low Voltage	V _{OL}	I _{OL} = 10 mA			0.35	V
Operating Supply Current	IDD	No load, 135 MHz		35		mA
Nominal Output Impedance	Z _O			17		Ω
Input Capacitance	C _{IN}	ICLK		5		pF

Notes: 1. Nominal switching threshold is VDD/2

VDD=2.5 V ±5%, Ambient temperature -40° to +105°C, unless stated otherwise

Parameter	Symbol	Conditions	Min.	Typ.	Max.	Units
Operating Voltage	VDD		2.375		2.625	V
Input High Voltage, ICLK	V _{IH}	Note 1	0.7xVDD		VDD	V
Input Low Voltage, ICLK	V _{IL}	Note 1			0.3xVDD	V
Output High Voltage	V _{OH}	I _{OH} = -16 mA	1.8			V
Output Low Voltage	V _{OL}	I _{OL} = 16 mA			0.5	V
Operating Supply Current	IDD	No load, 135 MHz		45		mA
Nominal Output Impedance	Z _O			17		Ω
Input Capacitance	C _{IN}	ICLK		5		pF

VDD=3.3 V ±5% , Ambient temperature -40° to +105°C, unless stated otherwise

Parameter	Symbol	Conditions	Min.	Typ.	Max.	Units
Operating Voltage	VDD		3.15		3.45	V
Input High Voltage, ICLK	V _{IH}	Note 1	0.7xVDD		VDD	V
Input Low Voltage, ICLK	V _{IL}	Note 1			0.3xVDD	V
Output High Voltage	V _{OH}	I _{OH} = -25 mA	2.2			V
Output Low Voltage	V _{OL}	I _{OL} = 25 mA			0.7	V
Operating Supply Current	IDD	No load, 135 MHz		55		mA
Nominal Output Impedance	Z _O			17		Ω
Input Capacitance	C _{IN}	ICLK		5		pF

AC Electrical Characteristics

(VDD = 1.8V, 2.5V, 3.3V)

VDD = 1.8V ±5%, Ambient Temperature -40° to +105°C, unless stated otherwise

Parameter	Symbol	Conditions	Min.	Typ.	Max.	Units
Input Frequency			0		200	MHz
Output Rise Time	t _{OR}	0.36 to 1.44 V, C _L =5 pF		1.4	1.9	ns
Output Fall Time	t _{OF}	1.44 to 0.36 V, C _L =5 pF		1.4	1.9	ns
Propagation Delay		Note 1	1.5	2.5	4	ns
Buffer Additive Phase Jitter, RMS		125MHz, Integration Range: 12kHz-20MHz			0.05	ps
Output to Output Skew		Rising edges at VDD/2, Note 2		50	65	ps
Device to Device Skew		Rising edges at VDD/2			200	ps
Start-up Time	t _{START-UP}	Part start-up time for valid outputs after VDD ramp-up			2	ms

VDD = 2.5 V ±5%, Ambient Temperature -40° to +105°C, unless stated otherwise

Parameter	Symbol	Conditions	Min.	Typ.	Max.	Units
Input Frequency			0		200	MHz
Output Rise Time	t _{OR}	0.5 to 2.0 V, C _L =5 pF		1.0	1.5	ns
Output Fall Time	t _{OF}	2.0 to 0.5 V, C _L =5 pF		1.0	1.5	ns
Propagation Delay		Note 1	1.8	2.5	4.5	ns
Buffer Additive Phase Jitter, RMS		125MHz, Integration Range: 12kHz-20MHz			0.05	ps
Output to Output Skew		Rising edges at VDD/2, Note 2		50	65	ps
Device to Device Skew		Rising edges at VDD/2			200	ps
Start-up Time	t _{START-UP}	Part start-up time for valid outputs after VDD ramp-up			2	ms

VDD = 3.3 V ±5%, Ambient Temperature -40° to +105°C, unless stated otherwise

Parameter	Symbol	Conditions	Min.	Typ.	Max.	Units
Input Frequency			0		200	MHz
Output Rise Time	t _{OR}	0.66 to 2.64 V, C _L =5 pF		0.6	1.0	ns
Output Fall Time	t _{OF}	2.64 to 0.66 V, C _L =5 pF		0.6	1.0	ns
Propagation Delay		Note 1	1.5	2.5	4	ns
Buffer Additive Phase Jitter, RMS		125MHz, Integration Range: 12kHz-20MHz			0.05	ps
Output to Output Skew		Rising edges at VDD/2, Note 2		50	65	ps
Device to Device Skew		Rising edges at VDD/2			200	ps
Start-up Time	t _{START-UP}	Part start-up time for valid outputs after VDD ramp-up			2	ms

Notes:

1. With rail to rail input clock
2. Between any 2 outputs with equal loading.
3. Duty cycle on outputs will match incoming clock duty cycle. Consult IDT for tight duty cycle clock generators.

Test Load and Circuit

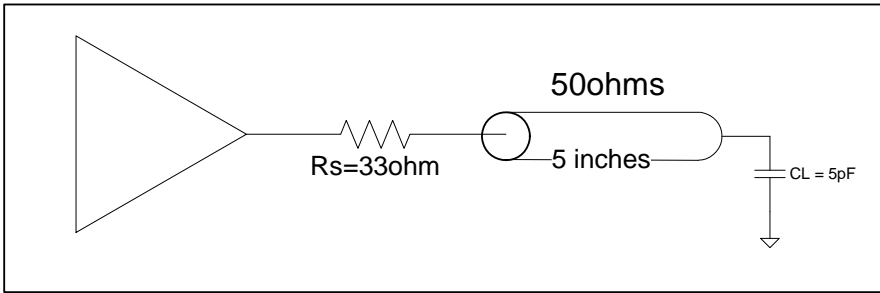

Marking Diagrams

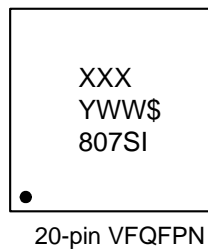
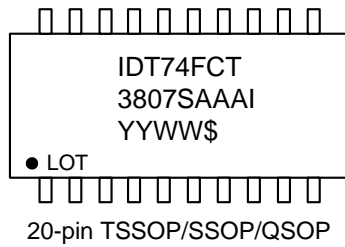

Notes:

1. "LOT" denotes the lot number.
2. "XXX" denotes the lot number.
3. "YYWW" or "YWW" are the last digits of the year and week that the part was assembled.
4. "\$" denotes mark code.
5. "I" denotes extended temperature range device.
6. "AAA" denotes package code.

Package Outline and Package Dimensions (20-pin VFQFPN)

- NOTE :
1. ALL DIMENSIONS ARE IN mm. ANGLES IN DEGREES.
 2. COPLANARITY APPLIES TO THE EXPOSED PAD AS WELL AS THE TERMINALS.
 3. WARRAGE SHALL NOT EXCEED 0.05 mm.
 4. PACKAGE LENGTH / PACKAGE WIDTH ARE CONSIDERED AS SPECIAL CHARACTERISTIC. (S)
 5. REFER JEDEC MO-220.

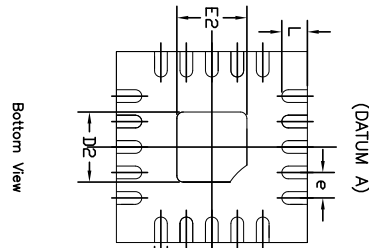
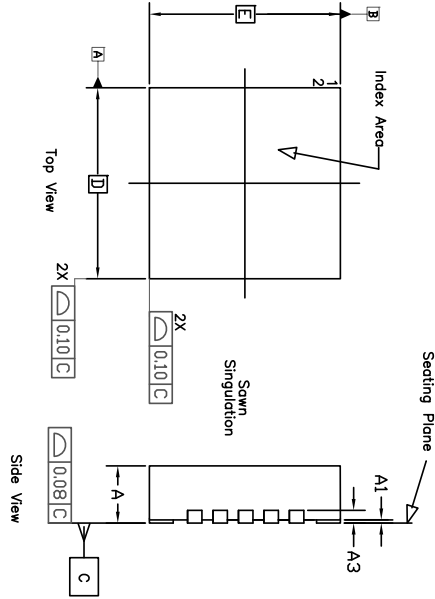

COMMON DIMENSION

Symbol	DIMENSION		
	Min	Nom	Max
A	0.80	0.90	1.00
A1	0	0.02	0.05
A3	0.20 Ref		
b	0.17	0.20	0.25
e	0.40 BASIC		
N	20		
ND	5		
NE	5		
D	3.00 BASIC		
E	3.00 BASIC		
D2	SEE EPAD OPTION		
E2	SEE EPAD OPTION		
L	0.30	0.40	0.50

REVISIONS			
REV	DESCRIPTION	DATE	APPROVED
00	INITIAL RELEASE	11/14/08	RC
01	ADD EPAD OPTION	11/28/12	RC
02	COMBINE PAD & LAND PATTERN	12/5/13	J.HUA
03	Change Dimension aaa	7/14/14	J.HUA

Symbol	P1			P2		
	MIN	NOM	MAX	MIN	NOM	MAX
E2	0.95	1.10	1.25	1.55	1.65	1.75
D2	0.95	1.10	1.25	1.55	1.65	1.75

TOLERANCES UNLESS SPECIFIED DECIMAL ANGULAR		<p>6024 Silver Creek Valley Road San Jose CA 95138 PHONE: (408) 284-8200 WWW.IDT.COM FAX: (408) 284-8991</p>
XXX+	E11	
APPROVALS	DATE	
DRAWN <i>RAJ</i>	11/14/08	
CHECKED		TITLE ND/NDG 20 PACKAGE OUTLINE 3.0 x 3.0 mm BODY, 0.40 PITCH OFN
SIZE	DRAWING No.	REV
C	PSC-4179	03
DO NOT SCALE DRAWING		SHEET 1 OF 2

Package Outline and Package Dimensions, cont. (20-pin VFQFPN)

REVISIONS			
REV	DESCRIPTION	DATE	APPROVED
00	INITIAL RELEASE	11/14/08	RC
01	ADD EPAD OPTION	11/28/12	RC
02	COMBINE POD & LAND PATTERN	12/5/13	J.HUA
03	Change dimension ooo	7/14/14	J.HUA

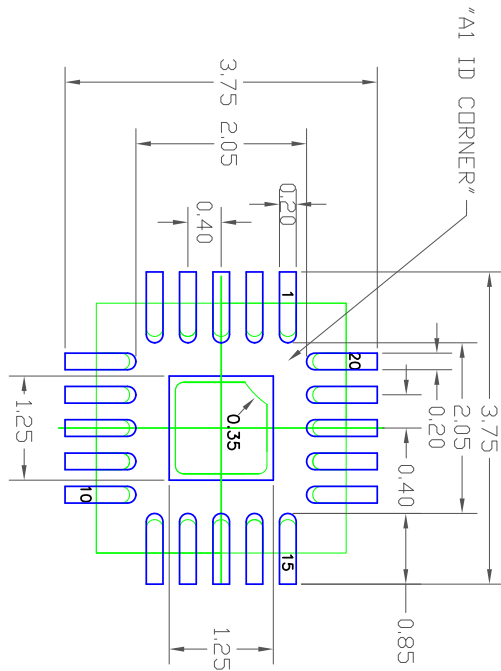

EPAD 1.1 mm SQ

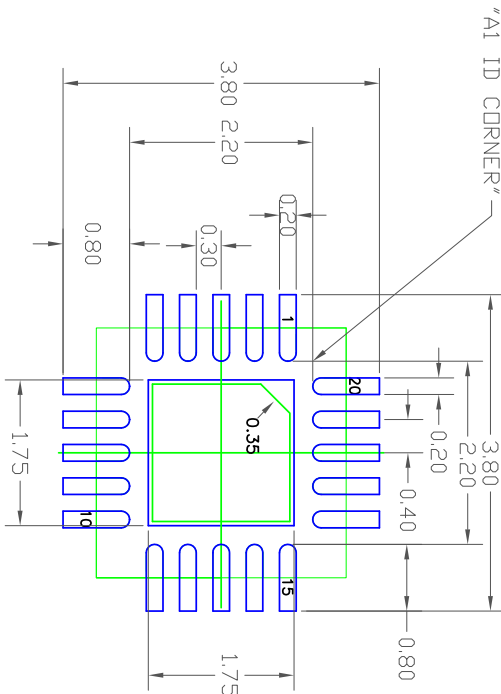

EPAD 1.65 mm SQ

RECOMMENDED LAND PATTERN DIMENSION

- NOTES:
1. ALL DIMENSION ARE IN mm, ANGLES IN DEGREES.
 2. TOP DOWN VIEW, AS VIEWED ON PCB.
 3. COMPONENT OUTLINE SHOW FOR REFERENCE IN GREEN.
 4. LAND PATTERN IN BLUE, NSMD PATTERN ASSUMED.
 5. LAND PATTERN RECOMMENDATION PER IPC-7351B GENERIC REQUIREMENT FOR SURFACE MOUNT DESIGN AND LAND PATTERN.

TOLERANCES UNLESS SPECIFIED		8024 Silver Creek Valley Road San Jose CA 95138	
DECIMAL	ANGULAR	PHONE: (408) 284-8200	
±0.1	±1°	FAX: (408) 294-8591	
XXX±		WWW.IDT.COM	
APPROVALS	DATE	TITLE ND/NDG 20 PACKAGE OUTLINE QFN	
DRAWN: RAG	11/14/08	3.0 x 3.0 mm BODY, 0.40 PITCH	
CHECKED		SIZE: DRAWING No. PSC-4179	
		C	
		DO NOT SCALE DRAWING	
		SHEET 2 OF 2	
		REV 03	

Package Outline and Package Dimensions (20-pin TSSOP)

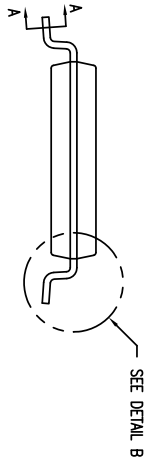
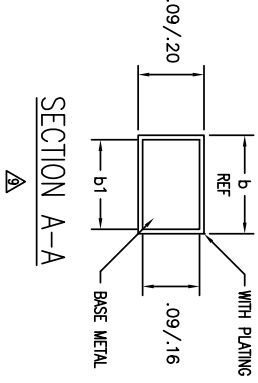
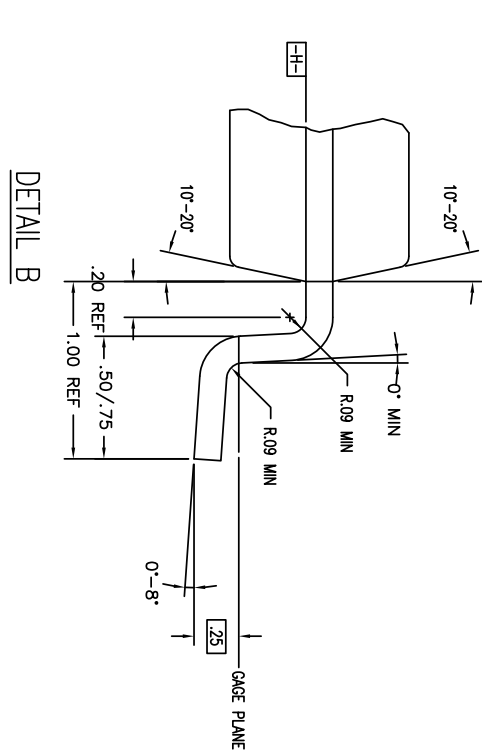
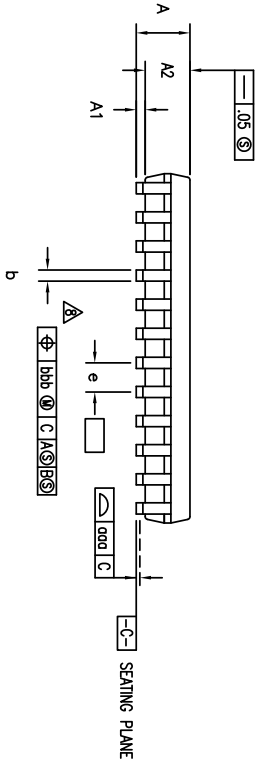
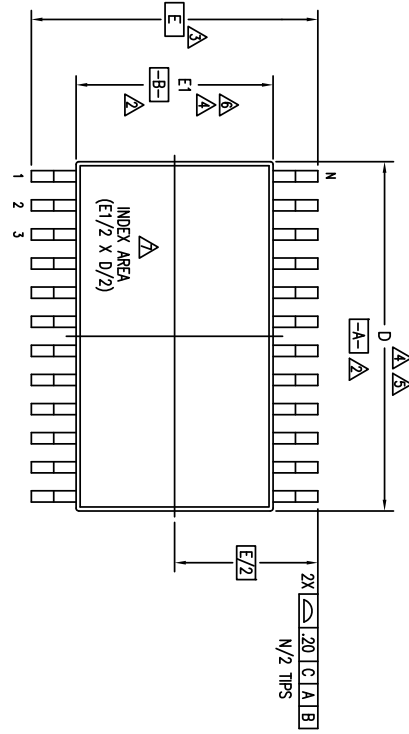

REVISIONS			
REV	DESCRIPTION	DATE	APPROVE
02	ADD 14 & 16 LD	08/29/98	T. YU
03	ADD 8 LD	07/10/99	T. YU
04	ADDED TOPMARK TO TITLE	5/23/01	TU YU
05	ADD "GREEN" PFG NOMENCLATURE	10/14/04	TU YU
06	ADDED PACKAGE CODE	3/8/13	RAC

TOLERANCES UNLESS SPECIFIED		IDT	
DECIMAL	ANGULAR	2975 Stender Way	Santa Clara, CA 95054
XXXXX	±	PHONE: (408) 727-6116	FAX: (408) 492-9874
APPROVALS	DATE	WWW.IDT.COM	
DRAWN 379	01/15/96	PG/PFG PACKAGE OUTLINE	
CHECKED		(PG OR PA TOPMARK CODE)	
		4.4 mm BODY WIDTH TSSOP .65 mm PITCH	
SIZE	DRAWING NO.	PSC-4056	
C		DO NOT SCALE DRAWING	
		SHEET 1 OF 01	

Package Outline and Package Dimensions, cont. (20-pin TSSOP)

NOTES:

- 1 ALL DIMENSIONING AND TOLERANCING CONFORM TO ASME Y14.5M-1994
- ▲ DATUMS **-A-** AND **-B-** TO BE DETERMINED AT DATUM PLANE **-H-**
- ▲ DIMENSION E TO BE DETERMINED AT SEATING PLANE **-C-**
- ▲ DIMENSIONS D AND E1 ARE TO BE DETERMINED AT DATUM PLANE **-H-**
- ▲ DIMENSION D DOES NOT INCLUDE MOLD FLASH, PROTRUSIONS OR GATE BURRS. MOLD FLASH, PROTRUSIONS OR GATE BURRS SHALL NOT EXCEED .15 mm PER SIDE
- ▲ DIMENSION E1 DOES NOT INCLUDE INTERLEAD FLASH OR PROTRUSIONS. INTERLEAD FLASH OR PROTRUSIONS SHALL NOT EXCEED .25 mm PER SIDE
- ▲ DETAIL OF PIN 1 IDENTIFIER IS OPTIONAL BUT MUST BE LOCATED WITHIN THE ZONE INDICATED
- ▲ LEAD WIDTH DIMENSION DOES NOT INCLUDE DAMBAR PROTRUSION. ALLOWABLE DAMBAR PROTRUSION IS .08 mm IN EXCESS OF THE LEAD WIDTH DIMENSION AT MAXIMUM MATERIAL CONDITION. DAMBAR CANNOT BE LOCATED ON THE LOWER RADIUS OR THE FOOT
- ▲ THESE DIMENSIONS APPLY TO THE FLAT SECTION OF THE LEAD BETWEEN .10 AND .25 mm FROM THE LEAD TIP
- 10 ALL DIMENSIONS ARE IN MILLIMETERS
- 11 THIS OUTLINE CONFORMS TO JEDEC PUBLICATION 95 REGISTRATION MO-153, VARIATION AA, AB-1, AB, AC, AD & AE

PG/PG620			
JEDEC VARIATION			
AC	NOM	MAX	N O T E
MIN	—	1.20	
—	—	.15	
.05	—	—	
.80	1.00	1.05	
6.40	6.50	6.60	4,5
6.40 BSC			3
4.30	4.40	4.50	4,6
.65 BSC			
.19	—	.30	
.19	.22	.25	
—	—	.10	
—	—	.10	
20			

REVISIONS			
REV	DESCRIPTION	DATE	APPROVED
02	ADD 14 & 16 LD	08/25/98	T. VU
03	ADD 8 LD	07/10/99	T. VU
04	ADDED TOPMARK TO TITLE	5/23/01	TU VU
05	ADD "GREEN" PGC NOMENCLATURE	10/14/04	TU VU
06	ADDED PACKAGE CODE	3/8/13	RAC

TOLERANCES UNLESS SPECIFIED		 2975 Stender Way Santa Clara, CA 95054 PHONE: (408) 727-6116 FAX: (408) 492-8674
DECIMAL	±	
ANGULAR	±	
XXX°	XXXX	
APPROVALS	DATE	TITLE
DRAWN 979	01/15/98	PG/PG6 PACKAGE OUTLINE (PG OR PA TOPMARK CODE)
CHECKED		4.4 mm BODY WIDTH TSSOP .65 mm PITCH
SIZE	DRAWING No.	REV
C	PSC-4056	06
DO NOT SCALE DRAWING		SHEET 2 OF 3

Package Outline and Package Dimensions, cont. (20-pin TSSOP)

LAND PATTERN DIMENSIONS

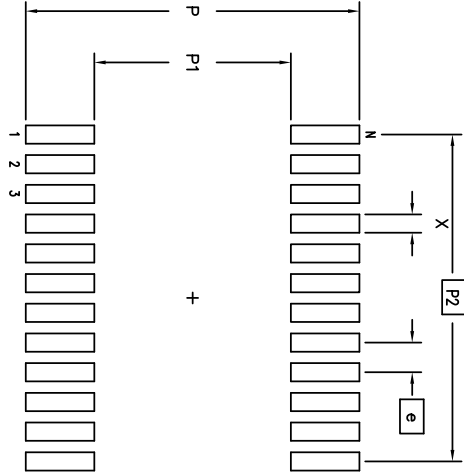

	MIN	MAX
	7.20	7.40
	4.20	4.40
	5.85 BSC	
	.30	.50
	.65 BSC	
	20	

REVISIONS			DATE	APPROVED
REV	DESCRIPTION			
02	ADD 14 & 16 LD		08/29/98	T. YU
03	ADD 8 LD		07/10/99	T. YU
04	ADDED TOPMARK TO TITLE		5/23/01	TU YU
05	ADD "GREEN" PGG NOMENCLATURE		10/14/04	TU YU
06	ADDED PACKAGE CODE		3/8/13	RAC

TOLERANCES UNLESS SPECIFIED			
DECIMAL	ANGULAR		
XXX±	±		
XXXX±			
APPROVALS		DATE	
DRAWN: JY		03/18/06	
CHECKED:			
TITLE		PG/PGG PACKAGE OUTLINE	
		(PG OR PA TOPMARK CODE)	
SIZE		4.4 mm BODY WIDTH TSSOP .65 mm PITCH	
DRAWING No.		PSC-4056	REV 06
DO NOT SCALE DRAWING			SHEET 3 OF 3

2975 Stender Way
Santa Clara, CA 95054
PHONE: (408) 727-6116
FAX: (408) 492-8674
WWW.IDT.COM

Package Outline and Package Dimensions (20-pin QSOP)

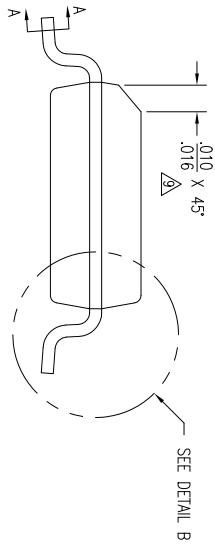
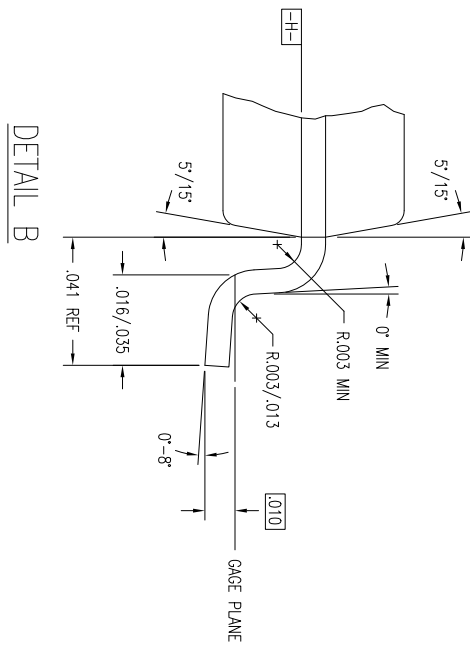
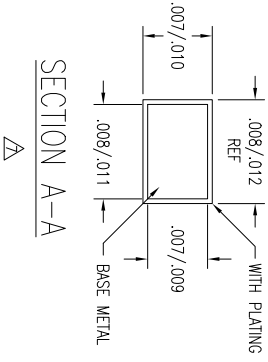
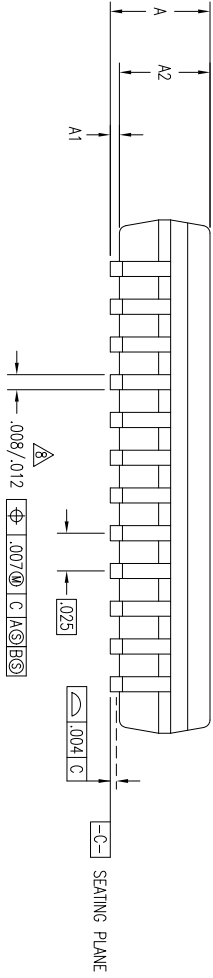
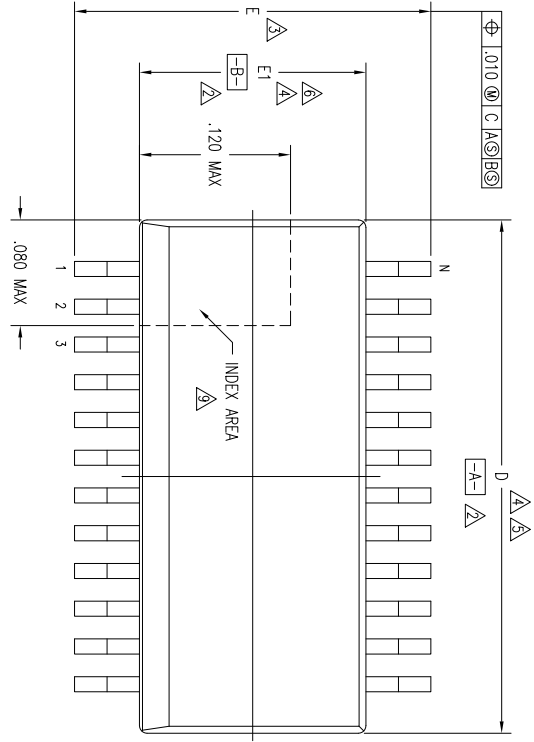

REVISIONS				
REV	DESCRIPTION	DATE	APPROV	
01	REDRAW TO JEDEC FORMAT	03/10/95	T. VU	
02	ADD 28 LD	08/15/95	T. VU	
03	CHANGE TO QSOP	12/15/99	S.SUE	
04	ADD "GREEN" POG NOMENCLATURE	10/08/04	TU VU	
05	CHANGE RADIUS DIM	11/15/11	OK LEE	

TOLERANCES UNLESS SPECIFIED			2975 Slender Way Santa Clara, CA 950 PHONE: (408) 727-61 FAX: (408) 492-8674
DECIMAL	±		
ANGULAR	±	www.IDT.com	
APPROVALS	DATE	TITLE	
DRAWN		PC/PCG PACKAGE OUTLINE	
CHECKED		.150" BODY WIDTH QSOP	
	SIZE	DRAWING No.	
	C	PSC-4040	
	R		
	C		
DO NOT SCALE DRAWING		SHEET	1 OF

Package Outline and Package Dimensions, cont. (20-pin QSOP)

REVISIONS				
DCN	REV	DESCRIPTION	DATE	APPROVED
28047	02	ADD 28 LD	08/15/95	T. VU
	03	CHANGE TO QSOP	12/15/99	S.SUE
	04	ADD "GREEN" PGC NOMENCLATURE	10/08/04	TU WU
	05	CHANGE RADIUS DIM	11/15/11	CK LEE

JEDEC VARIATION			
AD			N D T E
MIN	NOM	MAX	
.061	.064	.068	
.004	.006	.010	
.055	.058	.061	11
.337	.342	.344	4,5
.230	.236	.244	3
.150	.155	.157	4,6
			20

NOTES:

- ALL DIMENSIONING AND TOLERANCING CONFORM TO ANSI Y14.5M-1982
- DATUMS **-A-** AND **-B-** TO BE DETERMINED AT DATUM PLANE **-H-**
- DIMENSION E TO BE DETERMINED AT SEATING PLANE **-C-**
- DIMENSIONS D AND E1 ARE TO BE DETERMINED AT DATUM PLANE **-H-**
- DIMENSION D DOES NOT INCLUDE MOLD FLASH, PROTRUSIONS OR GATE BURRS; MOLD FLASH, PROTRUSIONS AND GATE BURRS SHALL NOT EXCEED .006 PER SIDE
- DIMENSION E1 DOES NOT INCLUDE INTERLEAD FLASH OR PROTRUSIONS; INTERLEAD FLASH OR PROTRUSIONS SHALL NOT EXCEED .010 PER SIDE
- THESE DIMENSIONS APPLY TO THE FLAT SECTION OF THE LEAD BETWEEN .005 AND .010 FROM LEAD TIP
- LEAD WIDTH DIMENSION DOES NOT INCLUDE DAMBAR PROTRUSION; ALLOWABLE DAMBAR PROTRUSION IS .004 IN EXCESS OF THE LEAD WIDTH DIMENSION AT MAXIMUM MATERIAL CONDITION. DAMBAR CANNOT BE LOCATED ON THE LOWER RADIUS OR THE FOOT
- THE CHAMFER ON THE PACKAGE BODY IS OPTIONAL. IF IT IS NOT PRESENT, A VISUAL INDEX FEATURE MUST BE LOCATED WITHIN THE ZONE INDICATED
- ALL DIMENSIONS ARE IN INCHES
- THIS OUTLINE CONFORMS TO JEDEC PUBLICATION 95 REGISTRATION MO-137, VARIATION AB, AD, AE & AF. EXCEPTIONS: JEDEC DIMENSION A2 MAX IS .059

LAND PATTERN DIMENSIONS

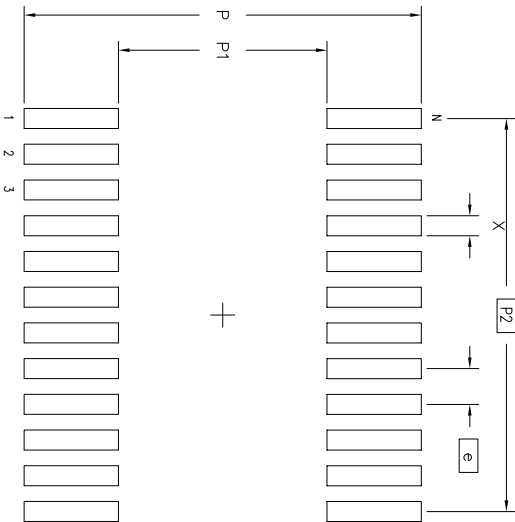

MIN	MAX
.274	.282
.142	.150
.225 BSC	
.010	.018
.025 BSC	
20	

TOLERANCES UNLESS SPECIFIED		 2975 Stender Way Santa Clara, CA 95054 PHONE: (408) 727-6116 FAX: (408) 492-8674
DECIMAL	ANGULAR	
± .005	± .005	
± .005	± .005	
APPROVALS	DATE	TITLE
DRAWN		PC/PGC PACKAGE OUTLINE
CHECKED		.150" BODY WIDTH QSOP
		.025" PITCH
		SIZE DRAWING No. PSC-4040
		DO NOT SCALE DRAWING
		SHEET 2 OF 2
		REV 05

Package Outline and Package Dimensions (20-pin SSOP)

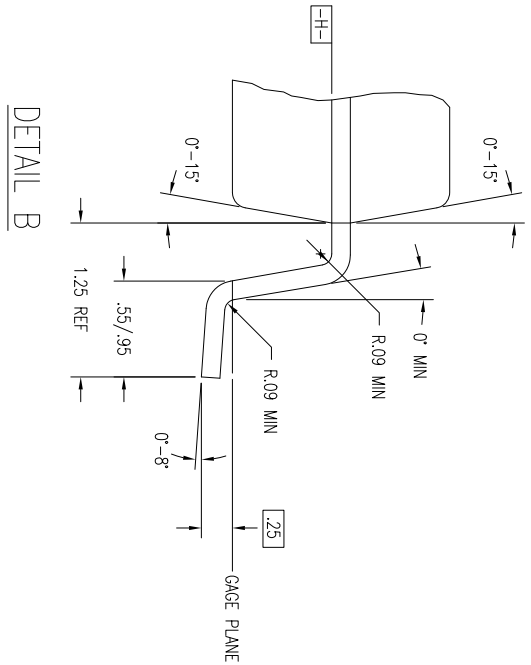
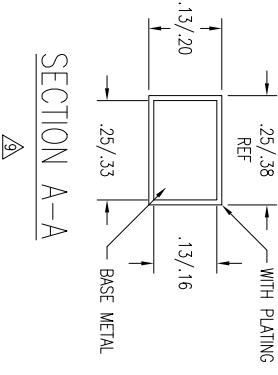
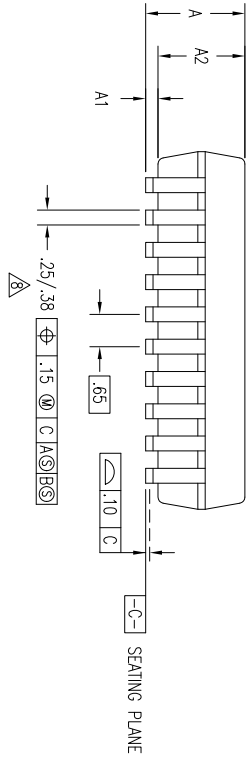
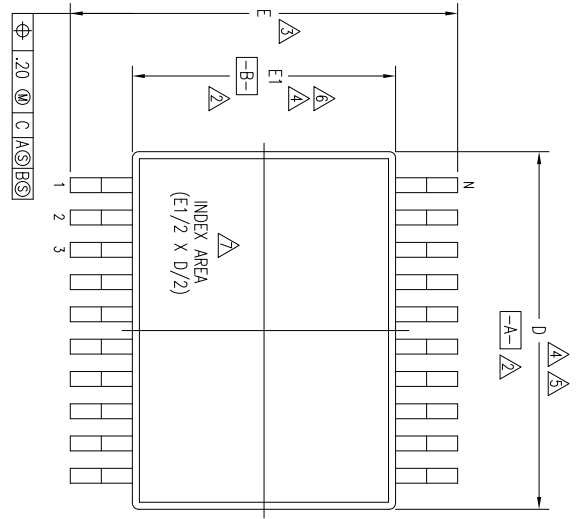

02	REDRAW TO JEDEC FORMAT	03/15/95	T. VU
03	ADD 14 & 16 LD	08/25/98	T. VU
04	ADDED TOPMARK TO TITLE	5/23/01	T. VU
05	ADD "GREEN" PYG NOMENCLATURE	10/12/04	TU VU
06	ADDED PACKAGE CODE	12/12/12	RC

TOLERANCES UNLESS SPECIFIED		DECIMAL		ANGULAR	
XXX±	±				
XXXX±					
APPROVALS	DATE	TITLE: PY/PYG PACKAGE OUTLINE (PY OR PV TOPMARK CODE)			
CHECKED		5.3 mm BODY WIDTH SSOP .65 mm PITCH			
SIZE	DRAWING No.	PSC-4032			
REV		06			

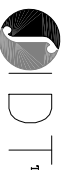
 6024 SILVERCREEK VALLEY F
 SAN JOSE CA 95138
 PHONE: (408) 284-8200
 FAX: (408) 294-8591
www.IDT.com

Package Outline and Package Dimensions, cont. (20-pin SSOP)

PY/PVCG20				N O T E
JEDEC VARIATION				
AE				
MIN	NOM	MAX		
1.73	1.86	1.99		
.05	.13	.21		
1.68	1.73	1.78		
7.07	7.20	7.33	4,5	
7.65	7.80	7.90	3	
5.20	5.30	5.38	4,6	
			20	

NOTES:

- 1 ALL DIMENSIONING AND TOLERANCING CONFORM TO ASME Y14.5M-1994
- 2 DATUMS **-A-** AND **-B-** TO BE DETERMINED AT DATUM PLANE **-H-**
- 3 DIMENSION E TO BE DETERMINED AT SEATING PLANE **-C-**
- 4 DIMENSIONS D AND E1 ARE TO BE DETERMINED AT DATUM PLANE **-H-**
- 5 DIMENSION D DOES NOT INCLUDE MOLD FLASH, PROTRUSIONS OR GATE BURRS. MOLD FLASH, PROTRUSIONS OR GATE BURRS SHALL NOT EXCEED .20 mm PER SIDE
- 6 DIMENSION E1 DOES NOT INCLUDE INTERLEAD FLASH OR PROTRUSIONS. INTERLEAD FLASH OR PROTRUSIONS SHALL NOT EXCEED .20 mm PER SIDE
- 7 DETAIL OF PIN 1 IDENTIFIER IS OPTIONAL BUT MUST BE LOCATED WITHIN THE ZONE INDICATED
- 8 LEAD WIDTH DIMENSION DOES NOT INCLUDE DAMBAR PROTRUSION. ALLOWABLE DAMBAR PROTRUSION IS .13 mm IN EXCESS OF THE LEAD WIDTH DIMENSION AT MAXIMUM MATERIAL CONDITION. DAMBAR CANNOT BE LOCATED ON THE LOWER RADII OR THE FOOT
- 9 THESE DIMENSIONS APPLY TO THE FLAT SECTION OF THE LEAD BETWEEN .10 AND .25 mm FROM THE LEAD TIP
- 10 ALL DIMENSIONS ARE IN MILLIMETERS
- 11 THIS OUTLINE CONFORMS TO JEDEC PUBLICATION 95 REGISTRATION MO-150, VARIATION AB, AC, AE, AG & AH

02	REDRAW TO JEDEC FORMAT	03/15
03	ADD 14 & 16 LD	08/25
04	ADDED TOPMARK TO TITLE	5/23
05	ADD "GREEN" PYG NOMENCLATURE	10/12
06	ADDED PACKAGE CODE	12/12

TOLERANCES UNLESS SPECIFIED		6024 SILV	
DECIMAL	ANGULAR	TM	SAN
xxx±	±	www.IDT.com	PHON
xxxx±			FAV:
xxxx±			
APPROVALS	DATE	TITLE PY/PVG PACKAGE OUTLINE (PY OR PV TOPMARK CODE 5.3 mm BODY WIDTH SSC)	
DRAWN		SIZE	DRAWING No.
CHECKED		C	PSC-402

Package Outline and Package Dimensions, cont. (20-pin SSOP)

LAND PATTERN DIMENSIONS

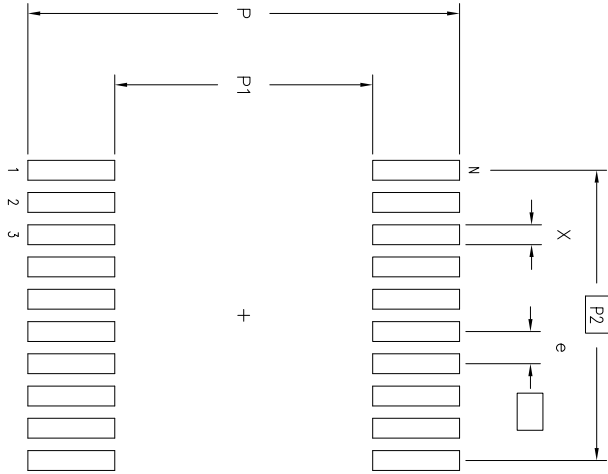

MIN	MAX
8.60	8.80
5.10	5.30
5.85 BSC	
.30	.40
.65 BSC	
20	

REV	DESCRIPTION	DATE	APPROVED
00	INITIAL RELEASE	04/15/91	T. VU
01	ADD 28 LD	07/27/93	T. VU
02	REDRAW TO JEDEC FORMAT	03/15/95	T. VU
03	ADD 14 & 16 LD	08/25/98	T. VU
04	ADDED TOPMARK TO TITLE	5/23/01	T. VU
05	ADD "GREEN" P'VG NOMENCLATURE	10/12/04	TU VU
06	ADDED PACKAGE CODE	12/12/12	RC

TOLERANCES UNLESS SPECIFIED	DECIMAL	ANGULAR
XXXX±	±	
XXXX±		
APPROVALS	DATE	
DRAWN		
CHECKED		

TITILE PY/PYVG PACKAGE OUTLINE
 (PY OR PV TOPMARK CODE)
 5.3 mm BODY WIDTH SSOP .65 mm PITCH
 SIZE | DRAWING No. | REV

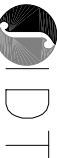
www.IDT.com

 6024 SILVERCREEK VALLEY RD
 SAN JOSE CA 95138
 PHONE: (408) 284-8200
 FAX: (408) 284-8591

Ordering Information

Part / Order Number	Marking	Shipping Packaging	Package	Temperature
74FCT3807SNDGI	see page 6	Tubes	20-pin VFQFPN	-40° to +105°C
74FCT3807SNDGI8		Tape and Reel	20-pin VFQFPN	-40° to +105°C
74FCT3807SPGGI		Tubes	20-pin TSSOP	-40° to +105°C
74FCT3807SPGGI8		Tape and Reel	20-pin TSSOP	-40° to +105°C
74FCT3807SQGI		Tubes	20-pin QSOP	-40° to +105°C
74FCT3807SQGI8		Tape and Reel	20-pin QSOP	-40° to +105°C
74FCT3807SPYGI		Tubes	20-pin SSOP	-40° to +105°C
74FCT3807SPYGI8		Tape and Reel	20-pin SSOP	-40° to +105°C

“G” after the two-letter package code denotes Pb-Free configuration, RoHS compliant.

Revision History

Rev.	Date	Originator	Description of Change
A	03/18/15	B. Chandhoke	Initial release.

