

74HC1G14; 74HCT1G14

Inverting Schmitt trigger

Rev. 6 — 27 December 2012

Product data sheet

1. General description

74HC1G14 and 74HCT1G14 are high-speed Si-gate CMOS devices. They provide an inverting buffer function with Schmitt trigger action. These devices are capable of transforming slowly changing input signals into sharply defined, jitter-free output signals.

The HC device has CMOS input switching levels and supply voltage range 2 V to 6 V.

The HCT device has TTL input switching levels and supply voltage range 4.5 V to 5.5 V.

The standard output currents are half of those of the 74HC14 and 74HCT14.

2. Features and benefits

- Symmetrical output impedance
- High noise immunity
- Low power dissipation
- Balanced propagation delays
- SOT353-1 and SOT753 package options
- Specified from $-40\text{ }^{\circ}\text{C}$ to $+125\text{ }^{\circ}\text{C}$

3. Applications

- Wave and pulse shapers
- Astable multivibrators
- Monostable multivibrators

4. Ordering information

Table 1. Ordering information

Type number	Package			
	Temperature range	Name	Description	Version
74HC1G14GW 74HCT1G14GW	$-40\text{ }^{\circ}\text{C}$ to $+125\text{ }^{\circ}\text{C}$	TSSOP5	plastic thin shrink small outline package; 5 leads; body width 1.25 mm	SOT353-1
74HC1G14GV 74HCT1G14GV	$-40\text{ }^{\circ}\text{C}$ to $+125\text{ }^{\circ}\text{C}$	SC-74A	plastic surface-mounted package; 5 leads	SOT753

5. Marking

Table 2. Marking codes

Type number	Marking code ^[1]
74HC1G14GW	HF
74HCT1G14GW	TF
74HC1G14GV	H14
74HCT1G14GV	T14

[1] The pin 1 indicator is located on the lower left corner of the device, below the marking code.

6. Functional diagram

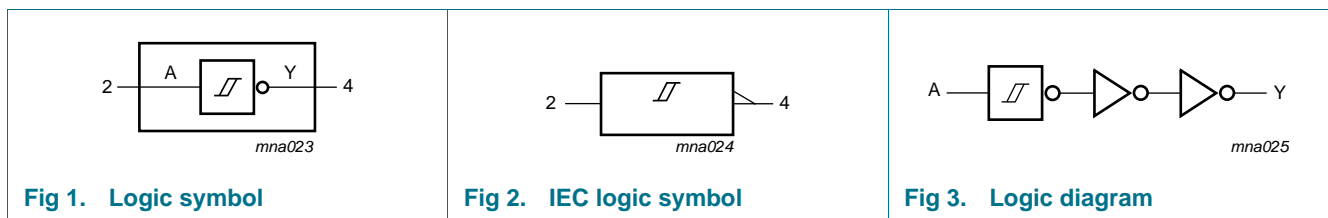

7. Pinning information

7.1 Pinning

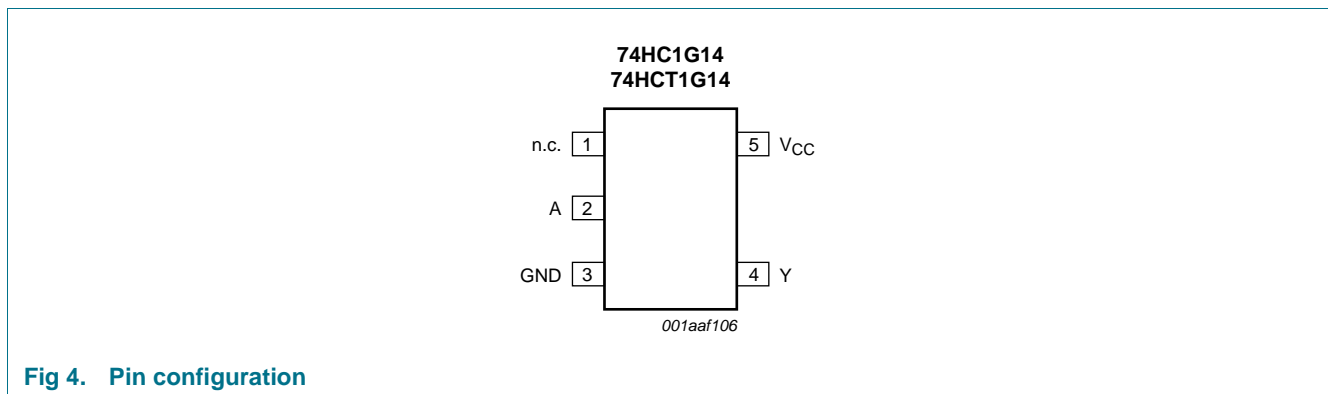

7.2 Pin description

Table 3. Pin description

Symbol	Pin	Description
n.c.	1	not connected
A	2	data input
GND	3	ground (0 V)
Y	4	data output
V _{CC}	5	supply voltage

8. Functional description

Table 4. Function table

H = HIGH voltage level; L = LOW voltage level

Input	Output
A	Y
L	H
H	L

9. Limiting values

Table 5. Limiting values

In accordance with the Absolute Maximum Rating System (IEC 60134). Voltages are referenced to GND (ground = 0 V). [\[1\]](#)

Symbol	Parameter	Conditions	Min	Max	Unit
V_{CC}	supply voltage		-0.5	+7.0	V
I_{IK}	input clamping current	$V_I < -0.5\text{ V}$ or $V_I > V_{CC} + 0.5\text{ V}$	-	± 20	mA
I_{OK}	output clamping current	$V_O < -0.5\text{ V}$ or $V_O > V_{CC} + 0.5\text{ V}$	-	± 20	mA
I_O	output current	$-0.5\text{ V} < V_O < V_{CC} + 0.5\text{ V}$	-	± 12.5	mA
I_{CC}	supply current		-	25	mA
I_{GND}	ground current		-25	-	mA
T_{stg}	storage temperature		-65	+150	°C
P_{tot}	total power dissipation	$T_{amb} = -40\text{ °C}$ to $+125\text{ °C}$	[2] -	200	mW

[1] The input and output voltage ratings may be exceeded if the input and output current ratings are observed.

[2] Above 55 °C, the value of P_{tot} derates linearly with 2.5 mW/K.

10. Recommended operating conditions

Table 6. Recommended operating conditions

Voltages are referenced to GND (ground = 0 V).

Symbol	Parameter	Conditions	74HC1G14			74HCT1G14			Unit
			Min	Typ	Max	Min	Typ	Max	
V_{CC}	supply voltage		2.0	5.0	6.0	4.5	5.0	5.5	V
V_I	input voltage		0	-	V_{CC}	0	-	V_{CC}	V
V_O	output voltage		0	-	V_{CC}	0	-	V_{CC}	V
T_{amb}	ambient temperature		-40	+25	+125	-40	+25	+125	°C

11. Static characteristics

Table 7. Static characteristics

Voltages are referenced to GND (ground = 0 V). All typical values are measured at $T_{amb} = 25\text{ °C}$.

Symbol	Parameter	Conditions	-40 °C to +85 °C			-40 °C to +125 °C		Unit
			Min	Typ	Max	Min	Max	
For type 74HC1G14								
V_{OH}	HIGH-level output voltage	$V_I = V_{T+}$ or V_{T-}						
		$I_O = -20\text{ }\mu\text{A}$; $V_{CC} = 2.0\text{ V}$	1.9	2.0	-	1.9	-	V
		$I_O = -20\text{ }\mu\text{A}$; $V_{CC} = 4.5\text{ V}$	4.4	4.5	-	4.4	-	V
		$I_O = -20\text{ }\mu\text{A}$; $V_{CC} = 6.0\text{ V}$	5.9	6.0	-	5.9	-	V
		$I_O = -2.0\text{ mA}$; $V_{CC} = 4.5\text{ V}$	4.13	4.32	-	3.7	-	V
		$I_O = -2.6\text{ mA}$; $V_{CC} = 6.0\text{ V}$	5.63	5.81	-	5.2	-	V
V_{OL}	LOW-level output voltage	$V_I = V_{T+}$ or V_{T-}						
		$I_O = 20\text{ }\mu\text{A}$; $V_{CC} = 2.0\text{ V}$	-	0	0.1	-	0.1	V
		$I_O = 20\text{ }\mu\text{A}$; $V_{CC} = 4.5\text{ V}$	-	0	0.1	-	0.1	V
		$I_O = 20\text{ }\mu\text{A}$; $V_{CC} = 6.0\text{ V}$	-	0	0.1	-	0.1	V
		$I_O = 2.0\text{ mA}$; $V_{CC} = 4.5\text{ V}$	-	0.15	0.33	-	0.4	V
		$I_O = 2.6\text{ mA}$; $V_{CC} = 6.0\text{ V}$	-	0.16	0.33	-	0.4	V
I_I	input leakage current	$V_I = V_{CC}$ or GND; $V_{CC} = 6.0\text{ V}$	-	-	1.0	-	1.0	μA
I_{CC}	supply current	$V_I = V_{CC}$ or GND; $I_O = 0\text{ A}$; $V_{CC} = 6.0\text{ V}$	-	-	10	-	20	μA
C_I	input capacitance		-	1.5	-	-	-	pF
V_{T+}	positive-going threshold voltage	see Figure 7 and Figure 8						
		$V_{CC} = 2.0\text{ V}$	0.7	1.09	1.5	0.7	1.5	V
		$V_{CC} = 4.5\text{ V}$	1.7	2.36	3.15	1.7	3.15	V
		$V_{CC} = 6.0\text{ V}$	2.1	3.12	4.2	2.1	4.2	V
V_{T-}	negative-going threshold voltage	see Figure 7 and Figure 8						
		$V_{CC} = 2.0\text{ V}$	0.3	0.60	0.9	0.3	0.9	V
		$V_{CC} = 4.5\text{ V}$	0.9	1.53	2.0	0.9	2.0	V
		$V_{CC} = 6.0\text{ V}$	1.2	2.08	2.6	1.2	2.6	V
V_H	hysteresis voltage	see Figure 7 and Figure 8						
		$V_{CC} = 2.0\text{ V}$	0.2	0.48	1.0	0.2	1.0	V
		$V_{CC} = 4.5\text{ V}$	0.4	0.83	1.4	0.4	1.4	V
		$V_{CC} = 6.0\text{ V}$	0.6	1.04	1.6	0.6	1.6	V
For type 74HCT1G14								
V_{OH}	HIGH-level output voltage	$V_I = V_{T+}$ or V_{T-}						
		$I_O = -20\text{ }\mu\text{A}$; $V_{CC} = 4.5\text{ V}$	4.4	4.5	-	4.4	-	V
		$I_O = -2.0\text{ mA}$; $V_{CC} = 4.5\text{ V}$	4.13	4.32	-	3.7	-	V
V_{OL}	LOW-level output voltage	$V_I = V_{T+}$ or V_{T-}						
		$I_O = 20\text{ }\mu\text{A}$; $V_{CC} = 4.5\text{ V}$	-	0	0.1	-	0.1	V
		$I_O = 2.0\text{ mA}$; $V_{CC} = 4.5\text{ V}$	-	0.15	0.33	-	0.4	V
I_I	input leakage current	$V_I = V_{CC}$ or GND; $V_{CC} = 5.5\text{ V}$	-	-	1.0	-	1.0	μA

Table 7. Static characteristics ...continued

Voltages are referenced to GND (ground = 0 V). All typical values are measured at $T_{amb} = 25\text{ °C}$.

Symbol	Parameter	Conditions	-40 °C to +85 °C			-40 °C to +125 °C		Unit
			Min	Typ	Max	Min	Max	
I_{CC}	supply current	$V_I = V_{CC}$ or GND; $I_O = 0\text{ A}$; $V_{CC} = 5.5\text{ V}$	-	-	10	-	20	μA
ΔI_{CC}	additional supply current	per input; $V_{CC} = 4.5\text{ V}$ to 5.5 V ; $V_I = V_{CC} - 2.1\text{ V}$; $I_O = 0\text{ A}$	-	-	500	-	850	μA
C_I	input capacitance		-	1.5	-	-	-	pF
V_{T+}	positive-going threshold voltage	see Figure 7 and Figure 8						
		$V_{CC} = 4.5\text{ V}$	1.2	1.55	1.9	1.2	1.9	V
		$V_{CC} = 5.5\text{ V}$	1.4	1.80	2.1	1.4	2.1	V
V_{T-}	negative-going threshold voltage	see Figure 7 and Figure 8						
		$V_{CC} = 4.5\text{ V}$	0.5	0.76	1.2	0.5	1.2	V
		$V_{CC} = 5.5\text{ V}$	0.6	0.90	1.4	0.6	1.4	V
V_H	hysteresis voltage	see Figure 7 and Figure 8						
		$V_{CC} = 4.5\text{ V}$	0.4	0.80	-	0.4	-	V
		$V_{CC} = 5.5\text{ V}$	0.4	0.90	-	0.4	-	V

12. Dynamic characteristics

Table 8. Dynamic characteristics

$GND = 0\text{ V}$; $t_r = t_f \leq 6.0\text{ ns}$; All typical values are measured at $T_{amb} = 25\text{ °C}$. For test circuit see [Figure 6](#)

Symbol	Parameter	Conditions	-40 °C to +85 °C			-40 °C to +125 °C		Unit
			Min	Typ	Max	Min	Max	
For type 74HC1G14								
t_{pd}	propagation delay	A to Y; see Figure 5	[1]					
		$V_{CC} = 2.0\text{ V}$; $C_L = 50\text{ pF}$	-	25	155	-	190	ns
		$V_{CC} = 4.5\text{ V}$; $C_L = 50\text{ pF}$	-	12	31	-	38	ns
		$V_{CC} = 5.0\text{ V}$; $C_L = 15\text{ pF}$	-	10	-	-	-	ns
		$V_{CC} = 6.0\text{ V}$; $C_L = 50\text{ pF}$	-	11	26	-	32	ns
C_{PD}	power dissipation capacitance	$V_I = GND$ to V_{CC}	[2]	20	-	-	-	pF
For type 74HCT1G14								
t_{pd}	propagation delay	A to Y; see Figure 5	[1]					
		$V_{CC} = 4.5\text{ V}$; $C_L = 50\text{ pF}$	-	17	43	-	51	ns
		$V_{CC} = 5.0\text{ V}$; $C_L = 15\text{ pF}$	-	15	-	-	-	ns
C_{PD}	power dissipation capacitance	$V_I = GND$ to $V_{CC} - 1.5\text{ V}$	[2]	22	-	-	-	pF

[1] t_{pd} is the same as t_{PLH} and t_{PHL} .

[2] C_{PD} is used to determine the dynamic power dissipation P_D (μW).

$$P_D = C_{PD} \times V_{CC}^2 \times f_i + \sum (C_L \times V_{CC}^2 \times f_o) \text{ where:}$$

f_i = input frequency in MHz; f_o = output frequency in MHz

C_L = output load capacitance in pF; V_{CC} = supply voltage in Volts

$\sum (C_L \times V_{CC}^2 \times f_o)$ = sum of outputs

13. Waveforms

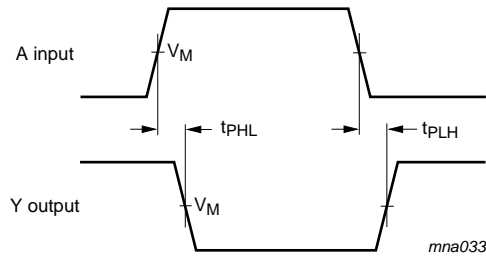

Measurement points are given in [Table 9](#).

Fig 5. The input (A) to output (Y) propagation delays

Table 9. Measurement points

Type number	Input		Output
	V_I	V_M	V_M
74HC1G14	GND to V_{CC}	$0.5 \times V_{CC}$	$0.5 \times V_{CC}$
74HCT1G14	GND to 3.0 V	1.5 V	$0.5 \times V_{CC}$

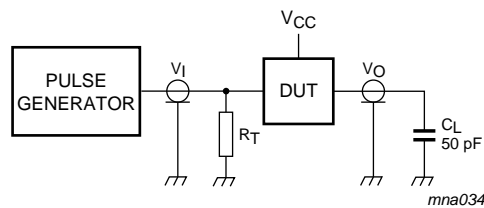

Test data is given in [Table 8](#). Definitions for test circuit:

C_L = Load capacitance including jig and probe capacitance.

R_T = Termination resistance should be equal to output impedance Z_o of the pulse generator.

Fig 6. Load circuitry for switching times

14. Transfer characteristics waveforms

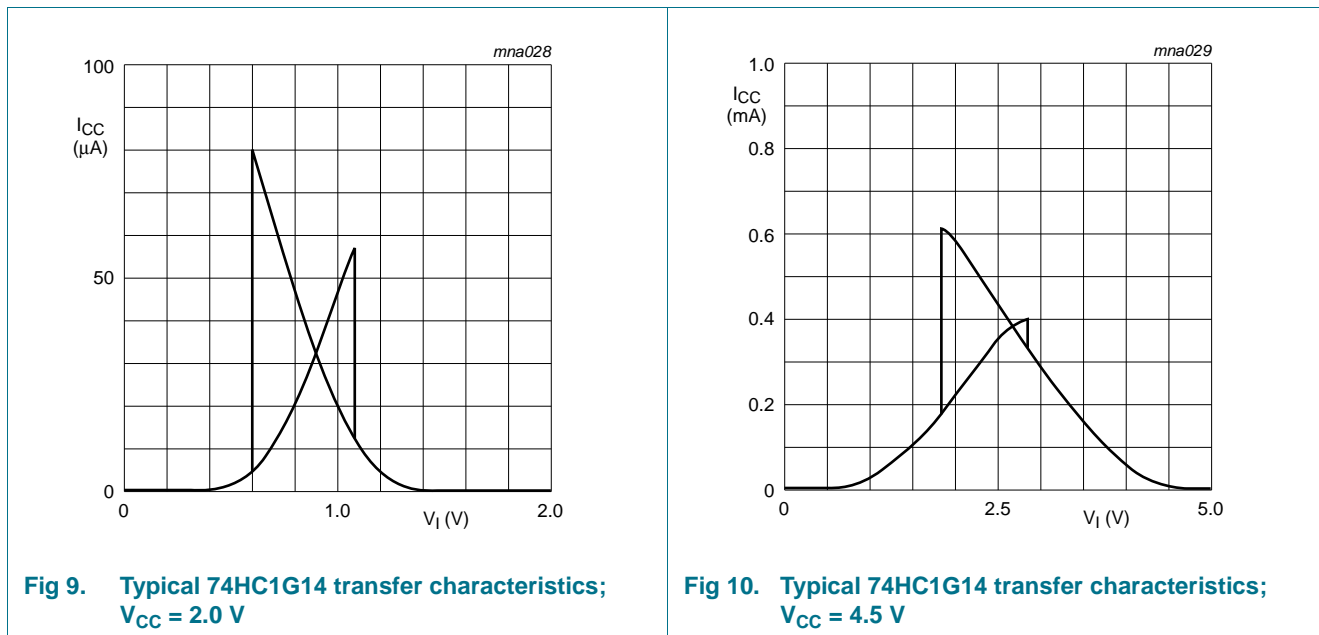
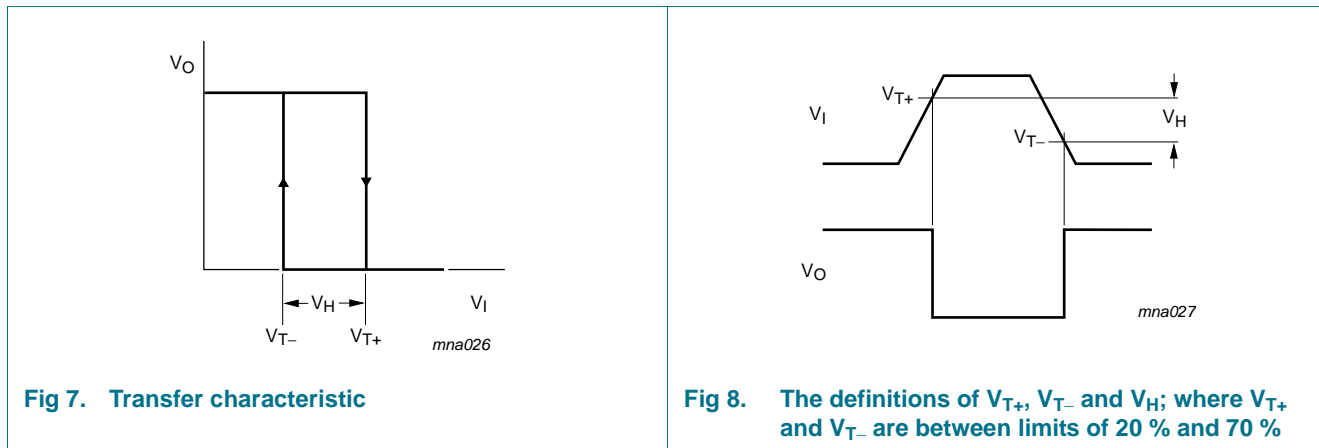

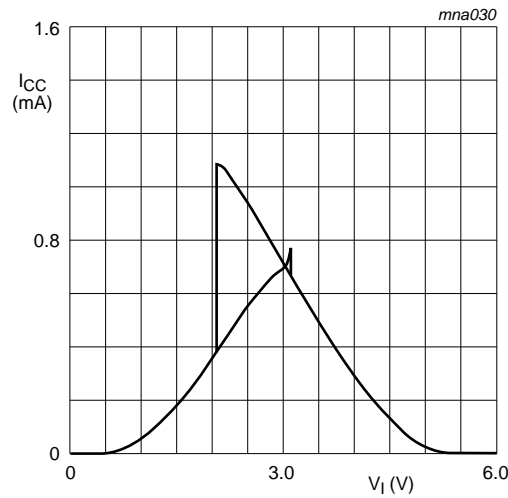

Fig 11. Typical 74HC1G14 transfer characteristics; $V_{CC} = 6.0\text{ V}$

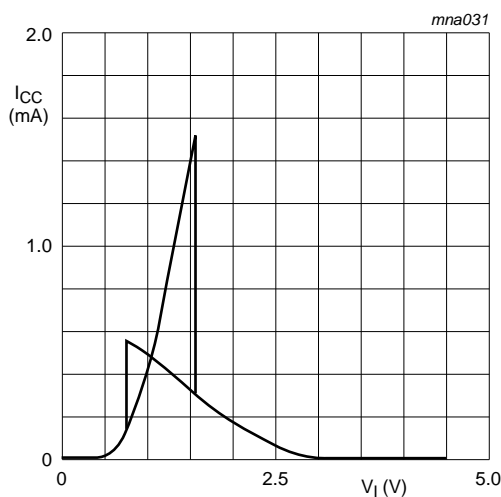

Fig 12. Typical 74HCT1G14 transfer characteristics; $V_{CC} = 4.5\text{ V}$

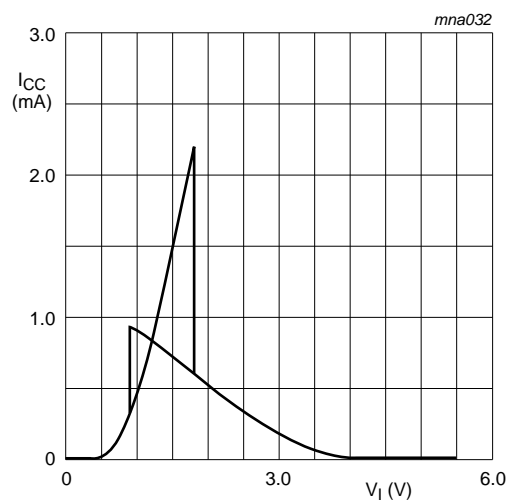

Fig 13. Typical 74HCT1G14 transfer characteristics; $V_{CC} = 5.5\text{ V}$

15. Application information

The slow input rise and fall times cause additional power dissipation, this can be calculated using the following formula:

$$P_{\text{add}} = f_i \times (t_r \times \Delta I_{CC(AV)} + t_f \times \Delta I_{CC(AV)}) \times V_{CC}$$

Where:

P_{add} = additional power dissipation (μW)

f_i = input frequency (MHz)

t_r = rise time (ns); 10 % to 90 %

t_f = fall time (ns); 90 % to 10 %

$\Delta I_{CC(AV)}$ = average additional supply current (μA)

$\Delta I_{CC(AV)}$ differs with positive or negative input transitions, as shown in [Figure 14](#) and [Figure 15](#).

74HC1G14 and 74HCT1G14 used in relaxation oscillator circuit, see [Figure 16](#).

Remark: All values given are typical unless otherwise specified.

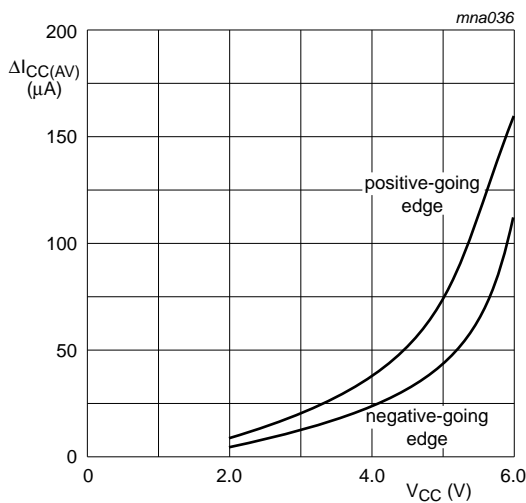

Fig 14. $\Delta I_{CC(AV)}$ for 74HC1G14 devices; linear change of V_I between $0.1 \times V_{CC}$ to $0.9 \times V_{CC}$

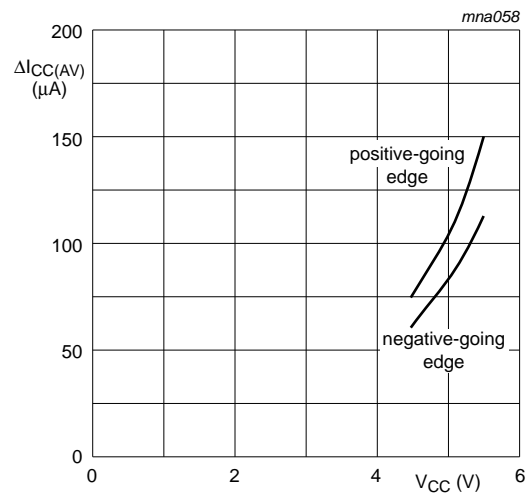
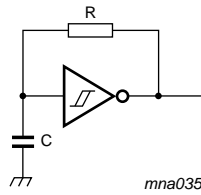

Fig 15. $\Delta I_{CC(AV)}$ for 74HCT1G14 devices; linear change of V_I between $0.1 \times V_{CC}$ to $0.9 \times V_{CC}$



For 74HC1G14 and 74HCT1G14: $f = \frac{1}{T} \approx \frac{1}{K \times RC}$

For K-factor, see [Figure 17](#)

Fig 16. Relaxation oscillator using 74HC1G14 and 74HCT1G14

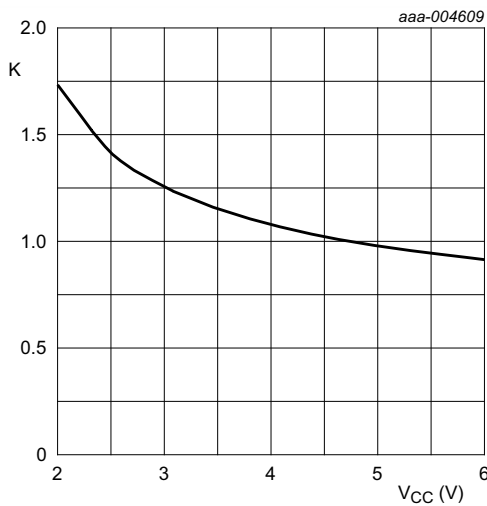

K-factor for 74HC1G14

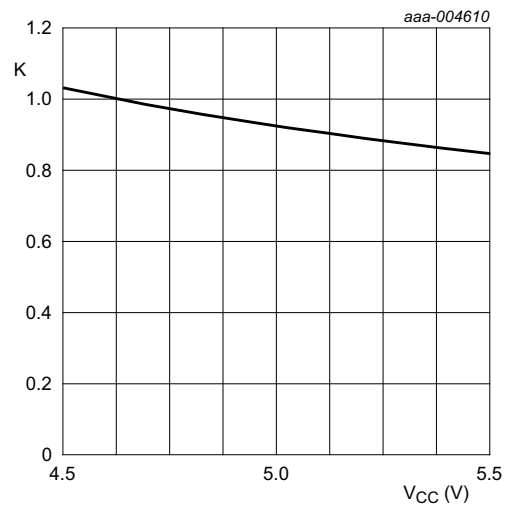

K-factor for 74HCT1G14

Fig 17. Typical K-factor for relaxation oscillator

16. Package outline

TSSOP5: plastic thin shrink small outline package; 5 leads; body width 1.25 mm

SOT353-1

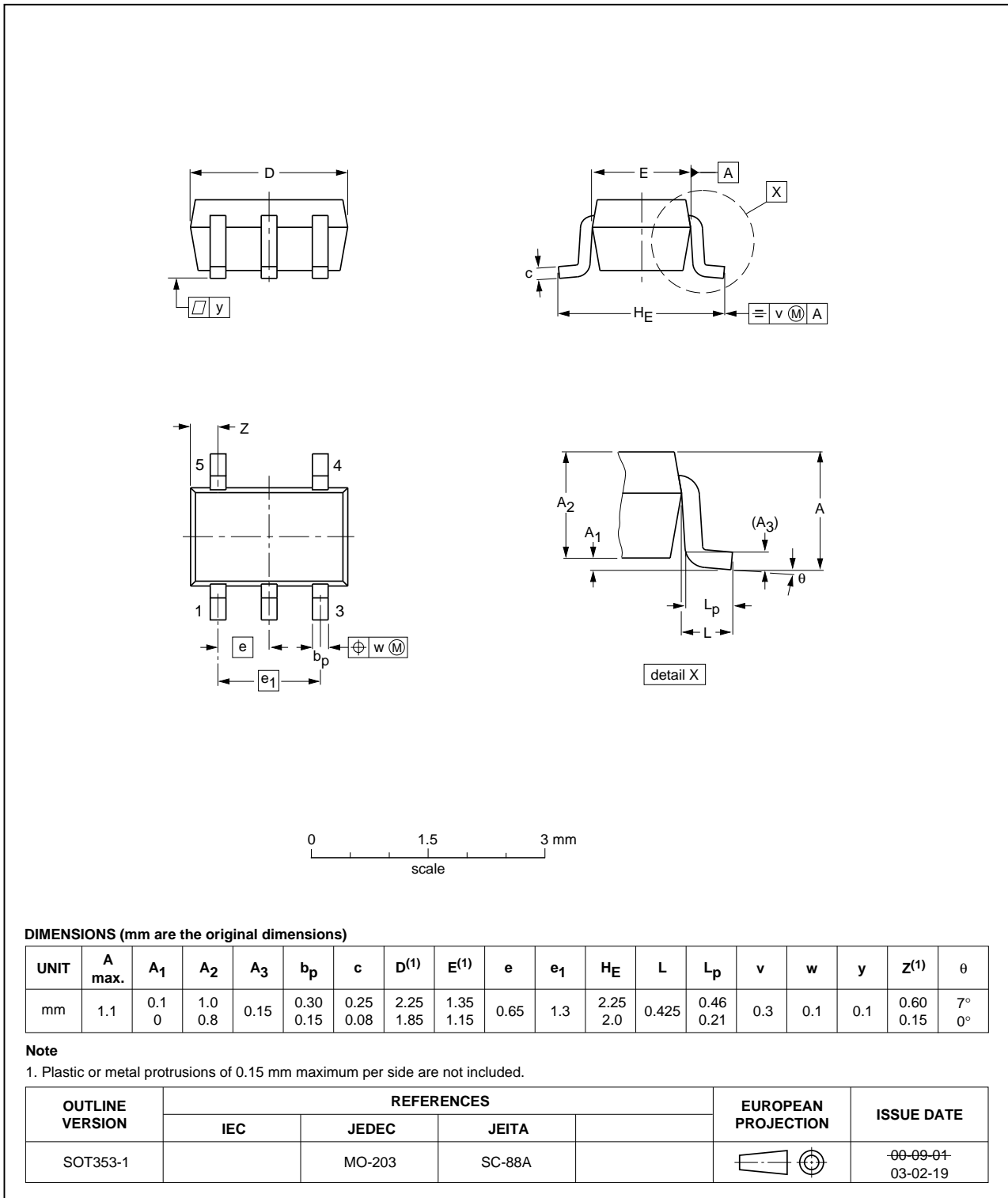

Fig 18. Package outline SOT353-1 (TSSOP5)

Plastic surface-mounted package; 5 leads

SOT753

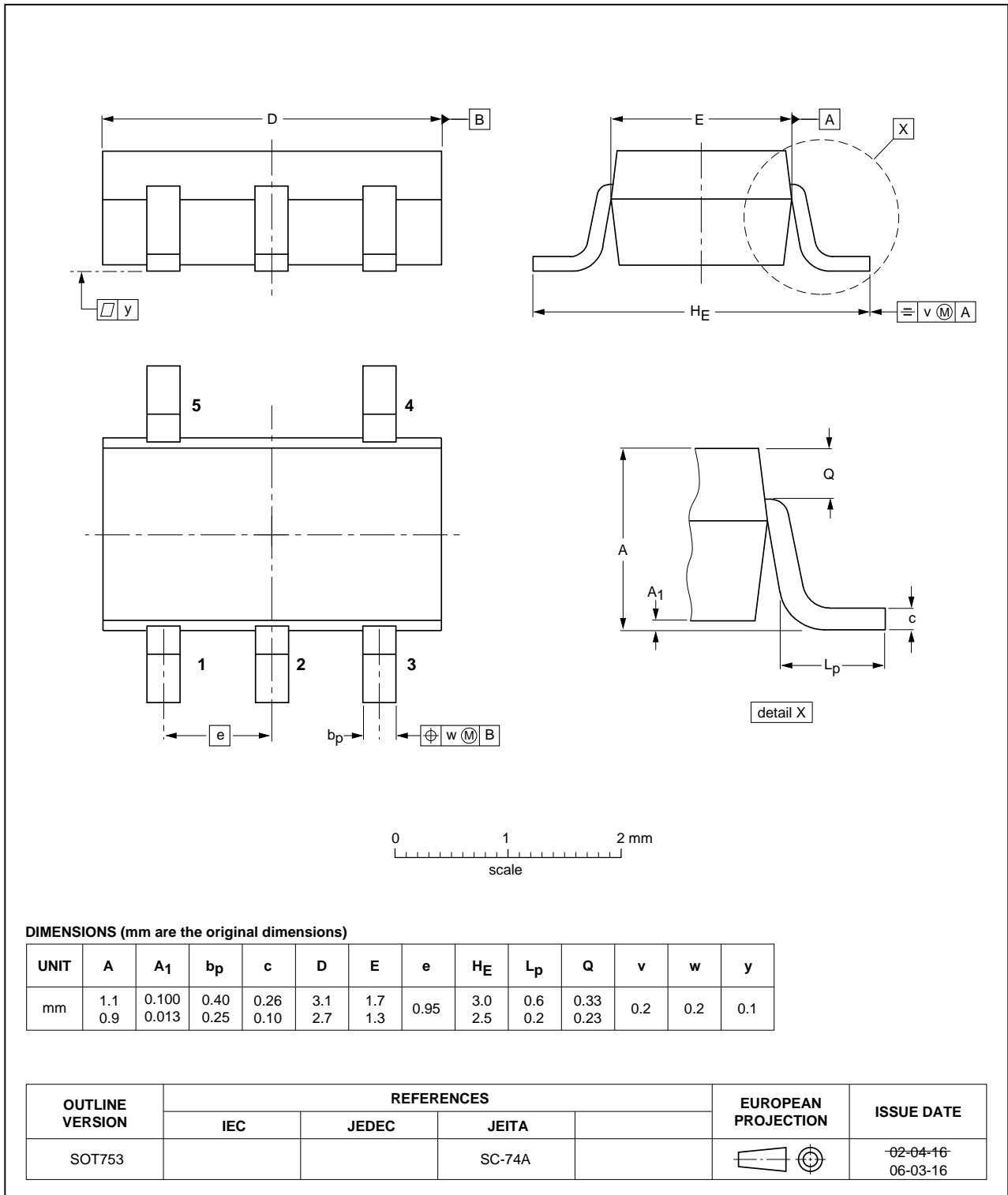

Fig 19. Package outline SOT753 (SC-74A)

17. Abbreviations

Table 10. Abbreviations

Acronym	Description
DUT	Device Under Test
TTL	Transistor-Transistor Logic

18. Revision history

Table 11. Revision history

Document ID	Release date	Data sheet status	Change notice	Supersedes
74HC_HCT1G14 v.6	20121227	Product data sheet	-	74HC_HCT1G14 v.5
Modifications:	<ul style="list-style-type: none"> • Table 3: Pin number Y output changed from 5 to 4 (errata). 			
74HC_HCT1G14 v.5	20120924	Product data sheet	-	74HC_HCT1G14 v.4
Modifications:	<ul style="list-style-type: none"> • Figure 17 added (typical K-factor for relaxation oscillator). • Legal page updated. 			
74HC_HCT1G14 v.4	20070717	Product data sheet	-	74HC_HCT1G14 v.3
74HC_HCT1G14 v.3	20020515	Product specification	-	74HC_HCT1G14 v.2
74HC_HCT1G14 v.2	20010302	Product specification	-	74HC_HCT1G14 v.1
74HC_HCT1G14 v.1	19980805	Product specification	-	-

19. Legal information

19.1 Data sheet status

Document status ^{[1][2]}	Product status ^[3]	Definition
Objective [short] data sheet	Development	This document contains data from the objective specification for product development.
Preliminary [short] data sheet	Qualification	This document contains data from the preliminary specification.
Product [short] data sheet	Production	This document contains the product specification.

[1] Please consult the most recently issued document before initiating or completing a design.

[2] The term 'short data sheet' is explained in section "Definitions".

[3] The product status of device(s) described in this document may have changed since this document was published and may differ in case of multiple devices. The latest product status information is available on the Internet at URL <http://www.nexperia.com>.

19.2 Definitions

Draft — The document is a draft version only. The content is still under internal review and subject to formal approval, which may result in modifications or additions. Nexperia does not give any representations or warranties as to the accuracy or completeness of information included herein and shall have no liability for the consequences of use of such information.

Short data sheet — A short data sheet is an extract from a full data sheet with the same product type number(s) and title. A short data sheet is intended for quick reference only and should not be relied upon to contain detailed and full information. For detailed and full information see the relevant full data sheet, which is available on request via the local Nexperia sales office. In case of any inconsistency or conflict with the short data sheet, the full data sheet shall prevail.

Product specification — The information and data provided in a Product data sheet shall define the specification of the product as agreed between Nexperia and its customer, unless Nexperia and customer have explicitly agreed otherwise in writing. In no event however, shall an agreement be valid in which the Nexperia product is deemed to offer functions and qualities beyond those described in the Product data sheet.

19.3 Disclaimers

Limited warranty and liability — Information in this document is believed to be accurate and reliable. However, Nexperia does not give any representations or warranties, expressed or implied, as to the accuracy or completeness of such information and shall have no liability for the consequences of use of such information. Nexperia takes no responsibility for the content in this document if provided by an information source outside of Nexperia.

In no event shall Nexperia be liable for any indirect, incidental, punitive, special or consequential damages (including - without limitation - lost profits, lost savings, business interruption, costs related to the removal or replacement of any products or rework charges) whether or not such damages are based on tort (including negligence), warranty, breach of contract or any other legal theory.

Notwithstanding any damages that customer might incur for any reason whatsoever, Nexperia's aggregate and cumulative liability towards customer for the products described herein shall be limited in accordance with the *Terms and conditions of commercial sale* of Nexperia.

Right to make changes — Nexperia reserves the right to make changes to information published in this document, including without limitation specifications and product descriptions, at any time and without notice. This document supersedes and replaces all information supplied prior to the publication hereof.

Suitability for use — Nexperia products are not designed, authorized or warranted to be suitable for use in life support, life-critical or safety-critical systems or equipment, nor in applications where failure or malfunction of a Nexperia product can reasonably be expected to result in personal injury, death or severe property or environmental damage. Nexperia and its suppliers accept no liability for inclusion and/or use of Nexperia products in such equipment or applications and therefore such inclusion and/or use is at the customer's own risk.

Applications — Applications that are described herein for any of these products are for illustrative purposes only. Nexperia makes no representation or warranty that such applications will be suitable for the specified use without further testing or modification.

Customers are responsible for the design and operation of their applications and products using Nexperia products, and Nexperia accepts no liability for any assistance with applications or customer product design. It is customer's sole responsibility to determine whether the Nexperia product is suitable and fit for the customer's applications and products planned, as well as for the planned application and use of customer's third party customer(s). Customers should provide appropriate design and operating safeguards to minimize the risks associated with their applications and products.

Nexperia does not accept any liability related to any default, damage, costs or problem which is based on any weakness or default in the customer's applications or products, or the application or use by customer's third party customer(s). Customer is responsible for doing all necessary testing for the customer's applications and products using Nexperia products in order to avoid a default of the applications and the products or of the application or use by customer's third party customer(s). Nexperia does not accept any liability in this respect.

Limiting values — Stress above one or more limiting values (as defined in the Absolute Maximum Ratings System of IEC 60134) will cause permanent damage to the device. Limiting values are stress ratings only and (proper) operation of the device at these or any other conditions above those given in the Recommended operating conditions section (if present) or the Characteristics sections of this document is not warranted. Constant or repeated exposure to limiting values will permanently and irreversibly affect the quality and reliability of the device.

Terms and conditions of commercial sale — Nexperia products are sold subject to the general terms and conditions of commercial sale, as published at <http://www.nexperia.com/profile/terms>, unless otherwise agreed in a valid written individual agreement. In case an individual agreement is concluded only the terms and conditions of the respective agreement shall apply. Nexperia hereby expressly objects to applying the customer's general terms and conditions with regard to the purchase of Nexperia products by customer.

No offer to sell or license — Nothing in this document may be interpreted or construed as an offer to sell products that is open for acceptance or the grant, conveyance or implication of any license under any copyrights, patents or other industrial or intellectual property rights.

Export control — This document as well as the item(s) described herein may be subject to export control regulations. Export might require a prior authorization from competent authorities.

Non-automotive qualified products — Unless this data sheet expressly states that this specific Nexperia product is automotive qualified, the product is not suitable for automotive use. It is neither qualified nor tested in accordance with automotive testing or application requirements. Nexperia accepts no liability for inclusion and/or use of non-automotive qualified products in automotive equipment or applications.

In the event that customer uses the product for design-in and use in automotive applications to automotive specifications and standards, customer (a) shall use the product without Nexperia's warranty of the product for such automotive applications, use and specifications, and (b) whenever customer uses the product for automotive applications beyond

Nexperia's specifications such use shall be solely at customer's own risk, and (c) customer fully indemnifies Nexperia for any liability, damages or failed product claims resulting from customer design and use of the product for automotive applications beyond Nexperia's standard warranty and Nexperia's product specifications.

Translations — A non-English (translated) version of a document is for reference only. The English version shall prevail in case of any discrepancy between the translated and English versions.

19.4 Trademarks

Notice: All referenced brands, product names, service names and trademarks are the property of their respective owners.

20. Contact information

For more information, please visit: <http://www.nexperia.com>

For sales office addresses, please send an email to: salesaddresses@nexperia.com