

# 74LV1T32

## 2-input single supply translating OR gate

Rev. 2 — 3 December 2019

Product data sheet

### 1. General description

---

The 74LV1T32 is a single, level translating 2-input OR gate. The low threshold inputs support 1.8 V input logic at  $V_{CC} = 3.3$  V and can be used in 1.8 V to 3.3 V level up translation. In addition, the 5 V tolerant input pins enable level down translation (3.3 V to 2.5 V output at  $V_{CC} = 2.5$  V). The output level is referenced to the supply voltage and supports 1.8 V, 2.5 V, 3.3 V and 5.0 V CMOS levels. The wide  $V_{CC}$  range permits the generation of output levels to connect to controllers or processors.

### 2. Features and benefits

---

- Single supply voltage translator at 1.8 V, 2.5 V, 3.3 V and 5.0 V
- Up translation
  - 1.2 V to 1.8 V at  $V_{CC} = 1.8$  V
  - 1.5 V to 2.5 V at  $V_{CC} = 2.5$  V
  - 1.8 V to 3.3 V at  $V_{CC} = 3.3$  V
  - 3.3 V to 5.0 V at  $V_{CC} = 5.0$  V
- Down translation
  - 3.3 V to 1.8 V at  $V_{CC} = 1.8$  V
  - 3.3 V to 2.5 V at  $V_{CC} = 2.5$  V
  - 5.0 V to 3.3 V at  $V_{CC} = 3.3$  V
- 5 V tolerant inputs
- Latch-up performance exceeds 250 mA per JESD 78 Class II
- ESD protection:
  - HBM ANSI/ESDA/JEDEC JS-001 Class 2 exceeds 2 kV
  - CDM JESD22-C101F exceeds 1 kV
- Specified from  $-40$  °C to  $+85$  °C and from  $-40$  °C to  $+125$  °C

### 3. Applications

---

- Portable applications
- PC and notebooks
- Industrial controller
- Telecom

## 4. Ordering information

Table 1. Ordering information

Type number	Package			Version
	Temperature range	Name	Description	
74LV1T32GW	-40 °C to +125 °C	TSSOP5	plastic thin shrink small outline package; 5 leads; body width 1.25 mm	SOT353-1
74LV1T32GV	-40 °C to +125 °C	SC-74A	plastic surface-mounted package; 5 leads	SOT753
74LV1T32GX	-40 °C to +125 °C	X2SON5	plastic thermal enhanced extremely thin small outline package; no leads; 5 terminals; body 0.8 x 0.8 x 0.35 mm	SOT1226

## 5. Marking

Table 2. Marking

Type number	Marking code[1]
74LV1T32GW	SB
74LV1T32GV	SB
74LV1T32GX	SB

[1] The pin 1 indicator is located on the lower left corner of the device, below the marking code.

## 6. Functional diagram

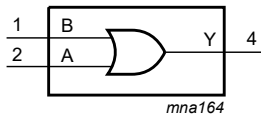

Fig. 1. Logic symbol

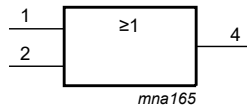

Fig. 2. IEC logic symbol

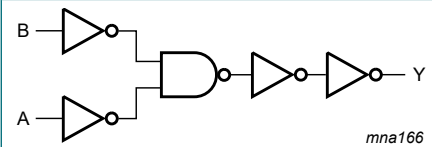

Fig. 3. Logic diagram

## 7. Pinning information

### 7.1. Pinning

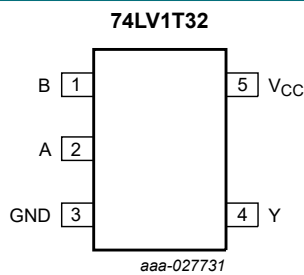

Fig. 4. Pin configuration SOT353-1 (TSSOP5) and SOT753 (SC-74A)

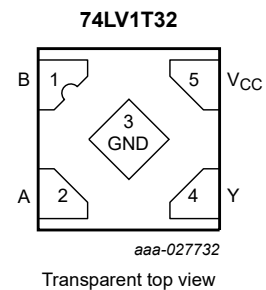

Fig. 5. Pin configuration SOT1226 (X2SON5)

### 7.2. Pin description

Table 3. Pin description

Symbol	Pin	Description
B	1	data input
A	2	data input
GND	3	ground (0 V)
Y	4	data output
V <sub>CC</sub>	5	supply voltage

## 8. Functional description

Table 4. Function table

*H = HIGH voltage level; L = LOW voltage level.*

Input		Output
A	B	Y
L	L	L
L	H	H
H	L	H
H	H	H

## 9. Limiting values

**Table 5. Limiting values**

In accordance with the Absolute Maximum Rating System (IEC 60134). Voltages are referenced to GND (ground = 0 V).

Symbol	Parameter	Conditions	Min	Max	Unit
$V_{CC}$	supply voltage		-0.5	+7.0	V
$V_I$	input voltage		-0.5	+7.0	V
$V_O$	output voltage	output HIGH or LOW state	-0.5	$V_{CC} + 0.5$	V
		output in power-off state	-0.5	4.6	V
$I_{IK}$	input clamping current	$V_I < 0$ V	-20	-	mA
$I_{OK}$	output clamping current	$V_O < 0$ V or $V_O > V_{CC}$	-	$\pm 20$	mA
$I_O$	output current	$V_O = 0$ V to $V_{CC}$	-	$\pm 25$	mA
$I_{CC}$	supply current		-	50	mA
$I_{GND}$	ground current		-50	-	mA
$T_{stg}$	storage temperature		-65	+150	°C
$P_{tot}$	total power dissipation	$T_{amb} = -40$ °C to +125 °C	-	250	mW

[1] If the input current ratings are observed, the minimum input voltage ratings may be exceeded.

[2] If the output current ratings are observed, the output voltage ratings may be exceeded.

[3] This value is limited to 7 V maximum.

[4] For SOT353-1 package: above 74 °C the value of  $P_{tot}$  derates linearly with 3.3 mW/K.

For SOT753 package: above 85 °C the value of  $P_{tot}$  derates linearly with 3.8 mW/K.

For SOT1226 package: above 67 °C the value of  $P_{tot}$  derates linearly with 3.0 mW/K.

## 10. Recommended operating conditions

**Table 6. Recommended operating conditions**

Voltages are referenced to GND (ground = 0 V).

Symbol	Parameter	Conditions	Min	Typ	Max	Unit
$V_{CC}$	supply voltage		1.6	5.0	5.5	V
$V_I$	input voltage		0	-	5.5	V
$V_O$	output voltage	output HIGH or LOW state	0	-	$V_{CC}$	V
$T_{amb}$	ambient temperature		-40	+25	+125	°C
$\Delta t/\Delta V$	input transition rise and fall rate	$V_{CC} = 1.8$ V to 5.0 V	-	-	20	ns/V

## 11. Static characteristics

**Table 7. Static characteristics**

Voltages are referenced to GND (ground = 0 V).

Symbol	Parameter	Conditions	25 °C		-40 °C to +85 °C		-40 °C to +125 °C		Unit
			Min	Max	Min	Max	Min	Max	
V <sub>IH</sub>	HIGH-level input voltage	V <sub>CC</sub> = 1.65 V to 1.8 V	0.94	-	1.0	-	1.0	-	V
		V <sub>CC</sub> = 2.0 V	0.99	-	1.03	-	1.03	-	V
		V <sub>CC</sub> = 2.25 V to 2.5 V	1.135	-	1.18	-	1.18	-	V
		V <sub>CC</sub> = 2.75 V	1.21	-	1.23	-	1.23	-	V
		V <sub>CC</sub> = 3.0 V to 3.3 V	1.35	-	1.37	-	1.37	-	V
		V <sub>CC</sub> = 3.6 V	1.47	-	1.48	-	1.48	-	V
		V <sub>CC</sub> = 4.5 V to 5.0 V	2.02	-	2.03	-	2.03	-	V
		V <sub>CC</sub> = 5.5 V	2.10	-	2.11	-	2.11	-	V
V <sub>IL</sub>	LOW-level input voltage	V <sub>CC</sub> = 1.65 V to 2.0 V	-	0.58	-	0.55	-	0.55	V
		V <sub>CC</sub> = 2.25 V to 2.75 V	-	0.75	-	0.71	-	0.71	V
		V <sub>CC</sub> = 3.0 V to 3.6 V	-	0.80	-	0.65	-	0.65	V
		V <sub>CC</sub> = 4.5 V to 5.5 V	-	0.80	-	0.80	-	0.80	V
V <sub>OH</sub>	HIGH-level output voltage	V <sub>I</sub> = V <sub>IH</sub> or V <sub>IL</sub> ;							
		V <sub>CC</sub> = 1.65 V to 5.5 V; I <sub>O</sub> = -20 µA	V <sub>CC</sub> -0.1	-	V <sub>CC</sub> -0.1	-	V <sub>CC</sub> -0.1	-	V
		V <sub>CC</sub> = 1.65 V; I <sub>O</sub> = -2 mA	1.28	-	1.21	-	1.21	-	V
		V <sub>CC</sub> = 1.8 V; I <sub>O</sub> = -2 mA	1.5	-	1.45	-	1.45	-	V
		V <sub>CC</sub> = 2.3 V; I <sub>O</sub> = -2.3 mA	2.0	-	2.0	-	2.0	-	V
		V <sub>CC</sub> = 2.3 V; I <sub>O</sub> = -3 mA	2.0	-	1.93	-	1.93	-	V
		V <sub>CC</sub> = 2.5 V; I <sub>O</sub> = -3 mA	2.25	-	2.15	-	2.15	-	V
		V <sub>CC</sub> = 3.0 V; I <sub>O</sub> = -3 mA	2.78	-	2.7	-	2.7	-	V
		V <sub>CC</sub> = 3.0 V; I <sub>O</sub> = -5.5 mA	2.6	-	2.49	-	2.49	-	V
		V <sub>CC</sub> = 3.3 V; I <sub>O</sub> = -5.5 mA	2.9	-	2.8	-	2.8	-	V
		V <sub>CC</sub> = 4.5 V; I <sub>O</sub> = -4 mA	4.2	-	4.1	-	4.1	-	V
V <sub>CC</sub> = 4.5 V; I <sub>O</sub> = -8 mA	4.1	-	3.95	-	3.95	-	V		
V <sub>CC</sub> = 5.0 V; I <sub>O</sub> = -8 mA	4.6	-	4.5	-	4.5	-	V		
V <sub>OL</sub>	LOW-level output voltage	V <sub>I</sub> = V <sub>IH</sub> or V <sub>IL</sub>							
		V <sub>CC</sub> = 1.65 V to 5.5 V; I <sub>O</sub> = 20 µA	-	0.1	-	0.1	-	0.1	V
		V <sub>CC</sub> = 1.65 V; I <sub>O</sub> = 2 mA	-	0.2	-	0.25	-	0.25	V
		V <sub>CC</sub> = 2.3 V; I <sub>O</sub> = 2.3 mA	-	0.1	-	0.15	-	0.15	V
		V <sub>CC</sub> = 2.3 V; I <sub>O</sub> = 3 mA	-	0.15	-	0.2	-	0.2	V
		V <sub>CC</sub> = 3.0 V; I <sub>O</sub> = 3 mA	-	0.1	-	0.15	-	0.15	V
		V <sub>CC</sub> = 3.0 V; I <sub>O</sub> = 5.5 mA	-	0.2	-	0.252	-	0.252	V
		V <sub>CC</sub> = 4.5 V; I <sub>O</sub> = 4 mA	-	0.15	-	0.2	-	0.2	V
V <sub>CC</sub> = 4.5 V; I <sub>O</sub> = 8 mA	-	0.3	-	0.35	-	0.35	V		
I <sub>I</sub>	input leakage current	V <sub>I</sub> = V <sub>CC</sub> or GND; V <sub>CC</sub> = 0 V to 5.5 V	-	±0.1	-	±1	-	±1	µA
I <sub>CC</sub>	supply current	V <sub>I</sub> = V <sub>CC</sub> or GND; I <sub>O</sub> = 0 A; V <sub>CC</sub> = 1.8 V, 2.5 V, 3.3 V, 5.0 V	-	1	-	10	-	10	µA

Symbol	Parameter	Conditions	25 °C		-40 °C to +85 °C		-40 °C to +125 °C		Unit
			Min	Max	Min	Max	Min	Max	
$\Delta I_{CC}$	additional supply current	per input pin; $V_{CC} = 1.8 \text{ V}$ ; $V_I = 0.3 \text{ V}$ or $1.1 \text{ V}$ ; $I_O = 0 \text{ A}$ ; other pins at $V_{CC}$ or GND	-	10	-	10	-	10	$\mu\text{A}$
		per input pin; $V_{CC} = 5.5 \text{ V}$ ; $V_I = 0.3 \text{ V}$ or $3.4 \text{ V}$ ; $I_O = 0 \text{ A}$ ; other pins at $V_{CC}$ or GND	-	1.35	-	1.5	-	1.5	mA

## 12. Dynamic characteristics

**Table 8. Dynamic characteristics**

$GND = 0 \text{ V}$ . For test circuit, see Fig. 7.

Symbol	Parameter	Conditions	25 °C			-40 °C to +85 °C		-40 °C to +125 °C		Unit
			Min	Typ	Max	Min	Max	Min	Max	
$t_{pd}$	propagation delay	A, B to Y; see Fig. 6 [1]	-							
		$V_{CC} = 1.8 \text{ V}$ ; $C_L = 15 \text{ pF}$	-	6.6	9.6	-	10.9	-	11.7	ns
		$V_{CC} = 1.8 \text{ V}$ ; $C_L = 30 \text{ pF}$	-	7.7	10.8	-	12.3	-	13.3	ns
		$V_{CC} = 2.5 \text{ V}$ ; $C_L = 15 \text{ pF}$	-	4.7	6.6	-	7.5	-	8.0	ns
		$V_{CC} = 2.5 \text{ V}$ ; $C_L = 30 \text{ pF}$	-	5.4	7.4	-	8.4	-	9.1	ns
		$V_{CC} = 3.3 \text{ V}$ ; $C_L = 15 \text{ pF}$	-	3.9	5.3	-	6.0	-	6.4	ns
		$V_{CC} = 3.3 \text{ V}$ ; $C_L = 30 \text{ pF}$	-	4.4	6.0	-	6.8	-	7.3	ns
		$V_{CC} = 5.0 \text{ V}$ ; $C_L = 15 \text{ pF}$	-	3.2	4.0	-	4.5	-	4.7	ns
		$V_{CC} = 5.0 \text{ V}$ ; $C_L = 30 \text{ pF}$	-	3.7	4.5	-	5.1	-	5.4	ns
$C_I$	input capacitance	$V_I = V_{CC}$ or GND; $V_{CC} = 3.3 \text{ V}$	-	1.5	10	-	10	-	10	pF
$C_O$	output capacitance	$V_O = V_{CC}$ or GND; $V_{CC} = 3.3 \text{ V}$	-	2.5	-	-	-	-	-	pF
$C_{PD}$	power dissipation capacitance	per buffer; $V_I = GND$ to $V_{CC}$ ; $C_L = 30 \text{ pF}$ ; $f = 10 \text{ MHz}$ [2]	-							
		$V_{CC} = 1.8 \text{ V}$	-	4.3	-	-	-	-	-	pF
		$V_{CC} = 2.5 \text{ V}$	-	5.7	-	-	-	-	-	pF
		$V_{CC} = 3.3 \text{ V}$	-	7.6	-	-	-	-	-	pF
		$V_{CC} = 5.0 \text{ V}$	-	11.9	-	-	-	-	-	pF

[1]  $t_{pd}$  is the same as  $t_{PLH}$  and  $t_{PHL}$ .

[2]  $C_{PD}$  is used to determine the dynamic power dissipation ( $P_D$  in  $\mu\text{W}$ ).

$$P_D = C_{PD} \times V_{CC}^2 \times f_i \times N + \sum(C_L \times V_{CC}^2 \times f_o) \text{ where:}$$

$f_i$  = input frequency in MHz;

$f_o$  = output frequency in MHz;

$C_L$  = output load capacitance in pF;

$V_{CC}$  = supply voltage in V;

$N$  = number of inputs switching;

$\sum(C_L \times V_{CC}^2 \times f_o)$  = sum of the outputs.

12.1. Waveforms and test circuit

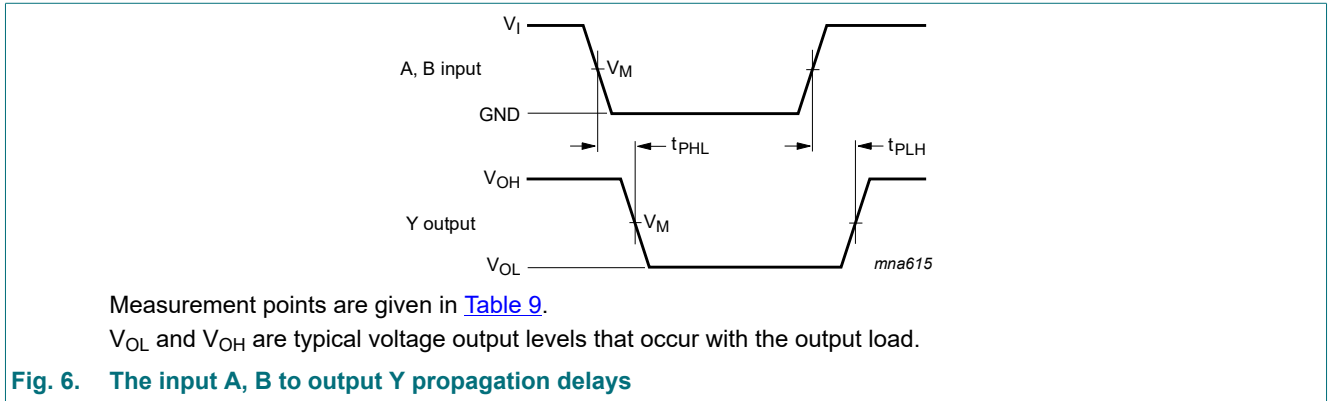

Table 9. Measurement points

Input	Output
$V_M$	$V_M$
$0.5V_I$	$0.5V_{CC}$

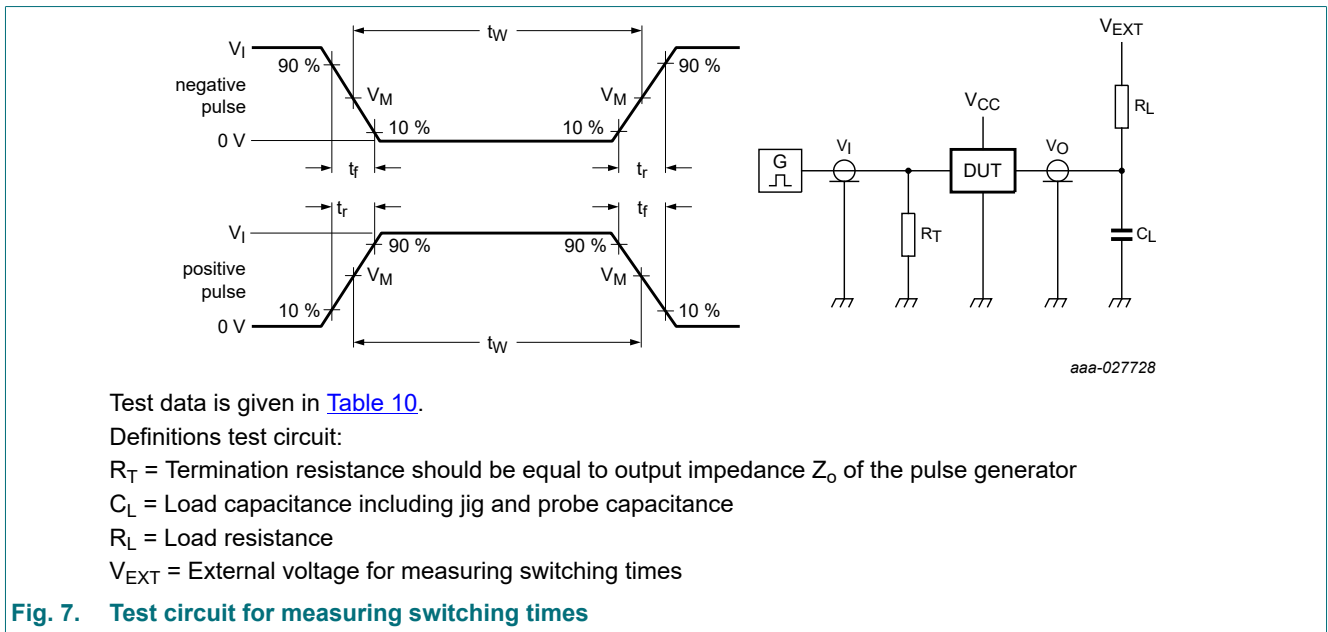

Table 10. Test data

Supply voltage	Input			Load		$V_{EXT}$		
	$V_I$	$\Delta t/\Delta V$ [1]	$f_{max}$	$C_L$	$R_L$	$t_{PLH}, t_{PHL}$	$t_{PZH}, t_{PHZ}$	$t_{PZL}, t_{PLZ}$
1.8 V	$V_{CC}$	$\leq 1.0 \text{ ns/V}$	15 MHz	15 pF, 30 pF	1M $\Omega$	GND	GND	$V_{CC}$
2.5 V	$V_{CC}$	$\leq 1.0 \text{ ns/V}$	25 MHz	15 pF, 30 pF	1M $\Omega$	GND	GND	$V_{CC}$
3.3 V	3 V	$\leq 1.0 \text{ ns/V}$	50 MHz	15 pF, 30 pF	1M $\Omega$	GND	GND	$V_{CC}$
5.0 V	3 V	$\leq 1.0 \text{ ns/V}$	50 MHz	15 pF, 30 pF	1M $\Omega$	GND	GND	$V_{CC}$

[1]  $dV/dt \geq 1.0 \text{ V/ns}$

13. Package outline

TSSOP5: plastic thin shrink small outline package; 5 leads; body width 1.25 mm

SOT353-1



DIMENSIONS (mm are the original dimensions)

UNIT	A max.	A <sub>1</sub>	A <sub>2</sub>	A <sub>3</sub>	b <sub>p</sub>	c	D <sup>(1)</sup>	E <sup>(1)</sup>	e	e <sub>1</sub>	H <sub>E</sub>	L	L <sub>p</sub>	v	w	y	Z <sup>(1)</sup>	θ
mm	1.1	0.1 0	1.0 0.8	0.15	0.30 0.15	0.25 0.08	2.25 1.85	1.35 1.15	0.65	1.3	2.25 2.0	0.425	0.46 0.21	0.3	0.1	0.1	0.60 0.15	7° 0°

Note

1. Plastic or metal protrusions of 0.15 mm maximum per side are not included.

OUTLINE VERSION	REFERENCES				EUROPEAN PROJECTION	ISSUE DATE
	IEC	JEDEC	JEITA			
SOT353-1		MO-203	SC-88A			00-09-01 03-02-19

Fig. 8. Package outline SOT353-1 (TSSOP5)



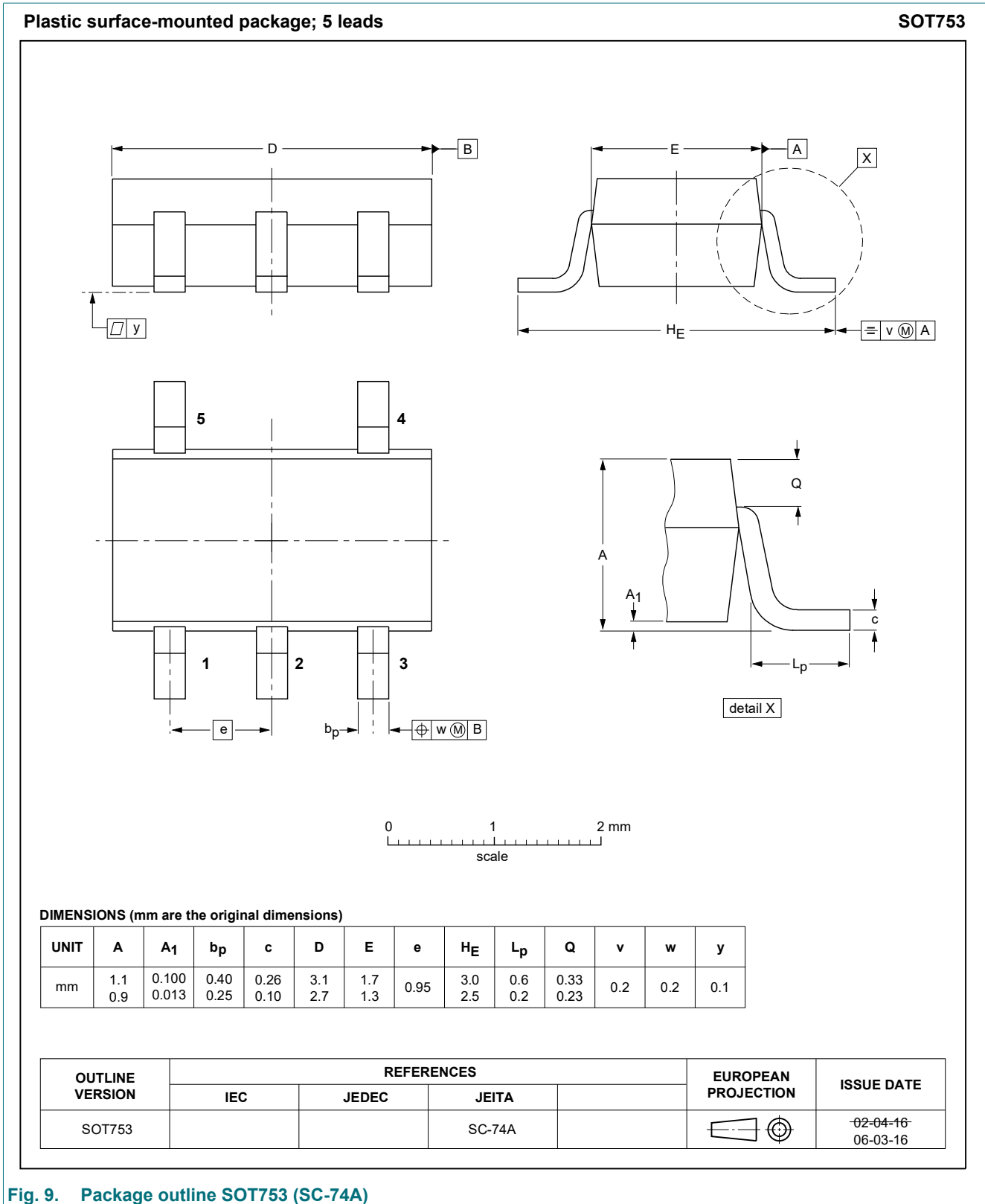
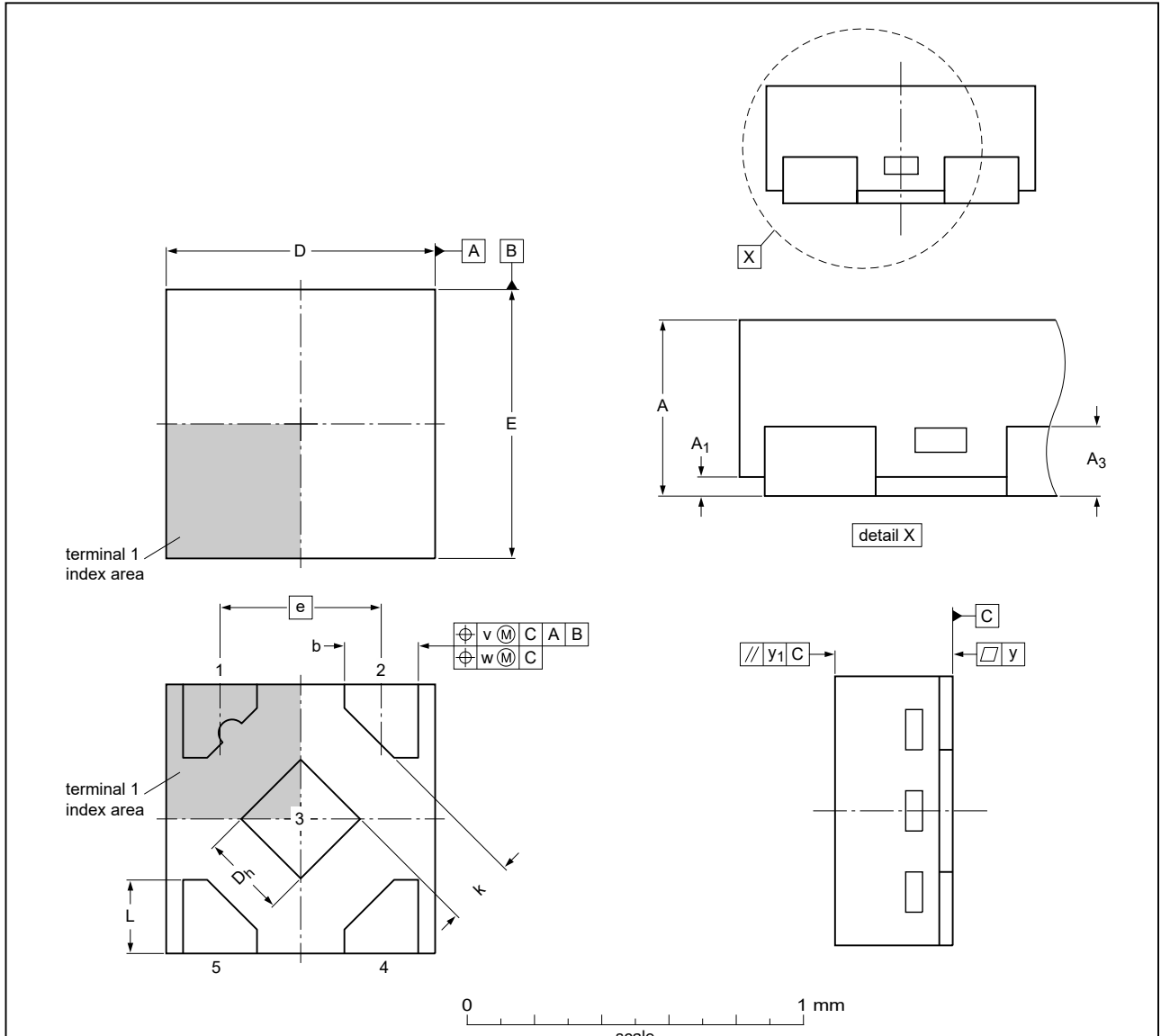

Fig. 9. Package outline SOT753 (SC-74A)

**X2SON5: plastic thermal enhanced extremely thin small outline package; no leads; 5 terminals; body 0.8 x 0.8 x 0.35 mm**

SOT1226



Dimensions

Unit	A <sup>(1)</sup>	A <sub>1</sub>	A <sub>3</sub>	D	D <sub>h</sub>	E	b	e	k	L	v	w	y	y <sub>1</sub>
max	0.35	0.04	0.128	0.85	0.30	0.85	0.27			0.27				
mm nom				0.80	0.25	0.80	0.22	0.48		0.22	0.1	0.05	0.05	0.05
min			0.040	0.75	0.20	0.75	0.17		0.20	0.17				

Note

1. Dimension A is including plating thickness.
2. Plastic or metal protrusions of 0.075 mm maximum per side are not included.

sot1226\_po

Outline version	References			European projection	Issue date
	IEC	JEDEC	EIAJ		
SOT1226					<del>12-04-10</del> 12-04-25

Fig. 10. Package outline SOT1226 (X2SON5)

## 14. Abbreviations

Table 11. Abbreviations

Acronym	Description
CDM	Charge Device Model
CMOS	Complementary Metal Oxide Semiconductor
DUT	Device Under Test
ESD	ElectroStatic Discharge
HBM	Human Body Model

## 15. Revision history

Table 12. Revision history

Document ID	Release date	Data sheet status	Change notice	Supersedes
74LV1T32 v.2	20191203	Product data sheet	-	74LV1T32 v.1
Modifications:	<ul style="list-style-type: none"> <li>Type number 74LV1T32GV (SOT753/SC-74A) added.</li> <li><a href="#">Table 5</a>: Derating values for <math>P_{tot}</math> total power dissipation updated.</li> </ul>			
74LV1T32 v.1	20171128	Product data sheet	-	-

## 16. Legal information

### Data sheet status

Document status [1][2]	Product status [3]	Definition
Objective [short] data sheet	Development	This document contains data from the objective specification for product development.
Preliminary [short] data sheet	Qualification	This document contains data from the preliminary specification.
Product [short] data sheet	Production	This document contains the product specification.

- [1] Please consult the most recently issued document before initiating or completing a design.
- [2] The term 'short data sheet' is explained in section "Definitions".
- [3] The product status of device(s) described in this document may have changed since this document was published and may differ in case of multiple devices. The latest product status information is available on the internet at <https://www.nexperia.com>.

### Definitions

**Draft** — The document is a draft version only. The content is still under internal review and subject to formal approval, which may result in modifications or additions. Nexperia does not give any representations or warranties as to the accuracy or completeness of information included herein and shall have no liability for the consequences of use of such information.

**Short data sheet** — A short data sheet is an extract from a full data sheet with the same product type number(s) and title. A short data sheet is intended for quick reference only and should not be relied upon to contain detailed and full information. For detailed and full information see the relevant full data sheet, which is available on request via the local Nexperia sales office. In case of any inconsistency or conflict with the short data sheet, the full data sheet shall prevail.

**Product specification** — The information and data provided in a Product data sheet shall define the specification of the product as agreed between Nexperia and its customer, unless Nexperia and customer have explicitly agreed otherwise in writing. In no event however, shall an agreement be valid in which the Nexperia product is deemed to offer functions and qualities beyond those described in the Product data sheet.

### Disclaimers

**Limited warranty and liability** — Information in this document is believed to be accurate and reliable. However, Nexperia does not give any representations or warranties, expressed or implied, as to the accuracy or completeness of such information and shall have no liability for the consequences of use of such information. Nexperia takes no responsibility for the content in this document if provided by an information source outside of Nexperia.

In no event shall Nexperia be liable for any indirect, incidental, punitive, special or consequential damages (including - without limitation - lost profits, lost savings, business interruption, costs related to the removal or replacement of any products or rework charges) whether or not such damages are based on tort (including negligence), warranty, breach of contract or any other legal theory.

Notwithstanding any damages that customer might incur for any reason whatsoever, Nexperia's aggregate and cumulative liability towards customer for the products described herein shall be limited in accordance with the Terms and conditions of commercial sale of Nexperia.

**Right to make changes** — Nexperia reserves the right to make changes to information published in this document, including without limitation specifications and product descriptions, at any time and without notice. This document supersedes and replaces all information supplied prior to the publication hereof.

**Suitability for use** — Nexperia products are not designed, authorized or warranted to be suitable for use in life support, life-critical or safety-critical systems or equipment, nor in applications where failure or malfunction of an Nexperia product can reasonably be expected to result in personal

injury, death or severe property or environmental damage. Nexperia and its suppliers accept no liability for inclusion and/or use of Nexperia products in such equipment or applications and therefore such inclusion and/or use is at the customer's own risk.

**Quick reference data** — The Quick reference data is an extract of the product data given in the Limiting values and Characteristics sections of this document, and as such is not complete, exhaustive or legally binding.

**Applications** — Applications that are described herein for any of these products are for illustrative purposes only. Nexperia makes no representation or warranty that such applications will be suitable for the specified use without further testing or modification.

Customers are responsible for the design and operation of their applications and products using Nexperia products, and Nexperia accepts no liability for any assistance with applications or customer product design. It is customer's sole responsibility to determine whether the Nexperia product is suitable and fit for the customer's applications and products planned, as well as for the planned application and use of customer's third party customer(s). Customers should provide appropriate design and operating safeguards to minimize the risks associated with their applications and products.

Nexperia does not accept any liability related to any default, damage, costs or problem which is based on any weakness or default in the customer's applications or products, or the application or use by customer's third party customer(s). Customer is responsible for doing all necessary testing for the customer's applications and products using Nexperia products in order to avoid a default of the applications and the products or of the application or use by customer's third party customer(s). Nexperia does not accept any liability in this respect.

**Limiting values** — Stress above one or more limiting values (as defined in the Absolute Maximum Ratings System of IEC 60134) will cause permanent damage to the device. Limiting values are stress ratings only and (proper) operation of the device at these or any other conditions above those given in the Recommended operating conditions section (if present) or the Characteristics sections of this document is not warranted. Constant or repeated exposure to limiting values will permanently and irreversibly affect the quality and reliability of the device.

**Terms and conditions of commercial sale** — Nexperia products are sold subject to the general terms and conditions of commercial sale, as published at <http://www.nexperia.com/profile/terms>, unless otherwise agreed in a valid written individual agreement. In case an individual agreement is concluded only the terms and conditions of the respective agreement shall apply. Nexperia hereby expressly objects to applying the customer's general terms and conditions with regard to the purchase of Nexperia products by customer.

**No offer to sell or license** — Nothing in this document may be interpreted or construed as an offer to sell products that is open for acceptance or the grant, conveyance or implication of any license under any copyrights, patents or other industrial or intellectual property rights.

**Export control** — This document as well as the item(s) described herein may be subject to export control regulations. Export might require a prior authorization from competent authorities.

**Non-automotive qualified products** — Unless this data sheet expressly states that this specific Nexperia product is automotive qualified, the product is not suitable for automotive use. It is neither qualified nor tested in accordance with automotive testing or application requirements. Nexperia accepts no liability for inclusion and/or use of non-automotive qualified products in automotive equipment or applications.

In the event that customer uses the product for design-in and use in automotive applications to automotive specifications and standards, customer (a) shall use the product without Nexperia's warranty of the product for such automotive applications, use and specifications, and (b) whenever customer uses the product for automotive applications beyond Nexperia's specifications such use shall be solely at customer's own risk, and (c) customer fully indemnifies Nexperia for any liability, damages or failed product claims resulting from customer design and use of the product for automotive applications beyond Nexperia's standard warranty and Nexperia's product specifications.

**Translations** — A non-English (translated) version of a document is for reference only. The English version shall prevail in case of any discrepancy between the translated and English versions.

### Trademarks

Notice: All referenced brands, product names, service names and trademarks are the property of their respective owners.