

Description

The 74LVC1G06Q is an automotive-compliant, single inverter with an open-drain output. The device is designed for operation with a power supply range of 1.65V to 5.5V. The inputs are tolerant to 5.5V allowing this device to be used in a mixed-voltage environment. The device is fully specified for partial power down applications using I_{OFF}. The I_{OFF} circuitry disables the output preventing damaging current backflow when the device is powered down. The open-drain output can be connected to other open drain outputs to implement active-low wired-OR or active-high wired-AND functions. The maximum sink current is 32mA at 5V.

Features

- Grade 1 Ambient Temperature Operation: -40°C to +125°C
- Wide Supply Voltage Range from 1.65V to 5.5V
- 24mA Sink Current at 3.3V
- CMOS Low Power Consumption
- I_{OFF} Supports Partial-Power-Down Mode Operation
- Inputs Accept up to 5.5V Regardless of V_{CC} Level
- ESD Protection Tested per AEC-Q100
- Exceeds 2000V Human Body Model (AEC-Q100-002)
- Exceeds 1000V Charged Device Model (AEC-Q100-011)
- Latch-Up Exceeds 100mA (AEC-Q100-004)
- **Totally Lead-Free & Fully RoHS Compliant (Notes 1 & 2)**
- **Halogen and Antimony Free. "Green" Device (Note 3)**
- **The 74LVC1G06Q is suitable for automotive applications requiring specific change control; this part is AEC-Q100 qualified, PPAP capable, and manufactured in IATF 16949 certified facilities.**

<https://www.diodes.com/quality/product-definitions/>

- Notes:
1. No purposely added lead. Fully EU Directive 2002/95/EC (RoHS), 2011/65/EU (RoHS 2) & 2015/863/EU (RoHS 3) compliant.
 2. See <https://www.diodes.com/quality/lead-free/> for more information about Diodes Incorporated's definitions of Halogen- and Antimony-free, "Green" and Lead-free.
 3. Halogen- and Antimony-free "Green" products are defined as those which contain <900ppm bromine, <900ppm chlorine (<1500ppm total Br + Cl) and <1000ppm antimony compounds.

Pin Assignments

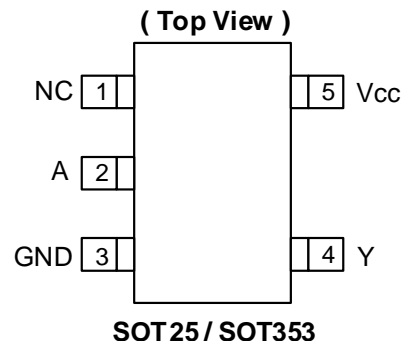

Applications

- Voltage Level Shifting
- General Purpose Logic
- Power Down Signal Isolation
- Wide Array of Products such as:
 - Automotive Applications within Grade 1 Temperature Range
 - Industrial Computing/Controls/Automation
 - High Reliability Networking/Communications
 - Industrial/Agricultural Equipment

Pin Descriptions

Pin Name	Description
NC	No Connection
A	Data Input
GND	Ground
Y	Data Output
V _{CC}	Supply Voltage

Logic Diagram

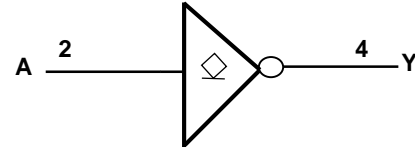

Function Table

Input	Output
A	Y
H	L
L	Z

Absolute Maximum Ratings (Notes 4 & 5)

Symbol	Description	Rating	Unit
ESD HBM	Human Body Model ESD Protection	2	kV
ESD CDM	Charged Device Model ESD Protection	1	kV
V _{CC}	Supply Voltage Range	-0.5 to 6.5	V
V _I	Input Voltage Range	-0.5 to 6.5	V
V _O	Voltage Applied to Output in High Impedance or I _{OFF} State	-0.5 to 6.5	V
V _O	Voltage Applied to Output in High or Low State	-0.5 to 6.5	V
I _{IK}	Input Clamp Current V _I < 0	-50	mA
I _{OK}	Output Clamp Current	-50	mA
I _O	Continuous Output Current	50	mA
I _{CC} , I _{GND}	Continuous Current Through V _{CC} or GND	±100	mA
T _J	Operating Junction Temperature	-40 to +150	°C
T _{STG}	Storage Temperature	-65 to +150	°C

- Notes:
- Stresses beyond the absolute maximum can result in immediate failure or reduced reliability. These are stress values and device operation should be within recommend values.
 - Forcing the maximum allowed voltage could cause a condition exceeding the maximum current or conversely forcing the maximum current could cause a condition exceeding the maximum voltage. The ratings of both current and voltage must be maintained within the controlled range.

Recommended Operating Conditions (Note 6)

Symbol	Parameter	Min	Max	Unit	
V _{CC}	Operating Voltage	Operating	1.65	5.5	V
		Data Retention Only	1.5	—	V
V _{IH}	High-Level Input Voltage	V _{CC} = 1.65V to 1.95V	0.65 × V _{CC}	—	V
		V _{CC} = 2.3V to 2.7V	1.7	—	
		V _{CC} = 3V to 3.6V	2	—	
		V _{CC} = 4.5V to 5.5V	0.7 × V _{CC}	—	
V _{IL}	Low-Level Input Voltage	V _{CC} = 1.65V to 1.95V	—	0.35 × V _{CC}	V
		V _{CC} = 2.3V to 2.7V	—	0.7	
		V _{CC} = 3V to 3.6V	—	0.8	
		V _{CC} = 4.5V to 5.5V	—	0.3 × V _{CC}	
V _I	Input Voltage	0	5.5	V	
V _O	Output Voltage	0	5.5	V	
I _{OL}	Low-Level Output Current	V _{CC} = 1.65V	—	4	mA
		V _{CC} = 2.3V	—	8	
		V _{CC} = 2.7V	—	12	
		V _{CC} = 3V	—	16	
		V _{CC} = 4.5V	—	24	
Δt/ΔV	Input Transition Rise or Fall Rate	V _{CC} = 1.8V ± 0.15V, 2.5V ± 0.2V	—	20	ns/V
		V _{CC} = 3.3V ± 0.3V	—	10	
		V _{CC} = 5V ± 0.5V	—	5	
T _A	Operating Free-Air Temperature	—	-40	+125	°C

Note: 6. Unused inputs should be held at V_{CC} or Ground.

Electrical Characteristics (All typical values are at $V_{CC} = 3.3V$, $T_A = +25^\circ C$.)

Symbol	Parameter	Test Conditions	Vcc	-40°C to +125°C			Unit	
				Min	Typ	Max		
V _{OL}	Low Level Output Voltage	V _I = V _{IH}	I _{OL} = 100µA	1.65V to 5.5V	—	—	0.1	V
			I _{OL} = 4mA	1.65V	—	—	0.45	
			I _{OL} = 8mA	2.3V	—	—	0.3	
			I _{OL} = 12mA	2.7V	—	—	0.4	
			I _{OL} = 24mA	3V	—	—	0.55	
			I _{OL} = 32mA	4.5V	—	—	0.55	
I _I	Input Current	V _I = 5.5V or GND	0 to 5.5V	—	±0.1	±1	µA	
I _{OFF}	Power Down Leakage Current	V _I or V _O = 5.5V	0V	—	—	±2	µA	
I _{oz}	Z-State Leakage Current	V _I = V _{IL} , V _O = 5.5V	1.65V or 5.5V	—	±0.1	±2	µA	
I _{CC}	Supply Current	V _I = 5.5V or GND, I _O = 0	5.5V	—	0.1	4	µA	
ΔI _{CC}	Additional Supply Current	Input at V _{CC} – 0.6V	3V to 5.5V	—	—	500	µA	
C _I	Input Capacitance	V _I = V _{CC} to GND	3.3V	—	5.0	—	pF	

Package Characteristics

Symbol	Parameter	Package	Test Conditions	Min	Typ	Max	Unit
θ _{JA}	Thermal Resistance Junction-to-Ambient	SOT25	Note 7	—	184	—	°C/W
		SOT353		—	385	—	
θ _{JC}	Thermal Resistance Junction-to-Case	SOT25	Note 7	—	62	—	°C/W
		SOT353		—	164	—	

Note: 7. Device mounted on FR-4 substrate PC board, 2oz copper, with minimum recommended pad layout.

Switching Characteristics

Figure 1 Typical Values at $T_A = +25^\circ C$ and nominal voltages 1.8V, 2.5V, 2.7V, 3.3V, and 5.0V.

Parameter	From Input	To Output	Vcc	T _A = -40°C to +125°C			Unit
				Min	Typ	Max	
t _{PD}	A	Y	1.8V ± 0.15V	1.0	3.0	8.5	ns
			2.5V ± 0.2V	0.5	1.9	5.5	
			2.7V	0.5	2.5	6.0	
			3.3V ± 0.3V	0.5	2.3	5.5	
			5.0V ± 0.5V	0.5	1.7	4.0	

Operating Characteristics

T_A = +25°C

Parameter	Test Conditions	Vcc = 1.8V	Vcc = 2.5V	Vcc = 3.3V	Vcc = 5V	Unit
		Typ	Typ	Typ	Typ	
C _{PD}	f = 10MHz	3	3	4	6	pF

Measurement Information

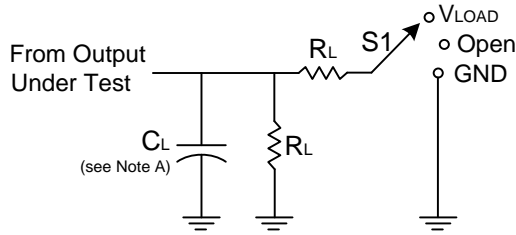

TEST	S1	CLRL
t_{PLZ}/t_{PZL}	V_{LOAD}	Per Table

V_{CC}	Inputs		V_M	V_{LOAD}	C_L	R_L	V_{Δ}
	V_I	t_R/t_F					
$1.8V \pm 0.15V$	V_{CC}	$\leq 2ns$	$V_{CC}/2$	$2 \times V_{CC}$	30pF	1k Ω	0.15V
$2.5V \pm 0.2V$	V_{CC}	$\leq 2ns$	$V_{CC}/2$	$2 \times V_{CC}$	30pF	500 Ω	0.15V
2.7V	2.7V	$\leq 2.5ns$	1.5V	6V	50pF	500 Ω	0.3V
$3.3V \pm 0.3V$	3V	$\leq 2.5ns$	1.5V	6V	50pF	500 Ω	0.3V
$5V \pm 0.5V$	V_{CC}	$\leq 2.5ns$	$V_{CC}/2$	$2 \times V_{CC}$	50pF	500 Ω	0.3V

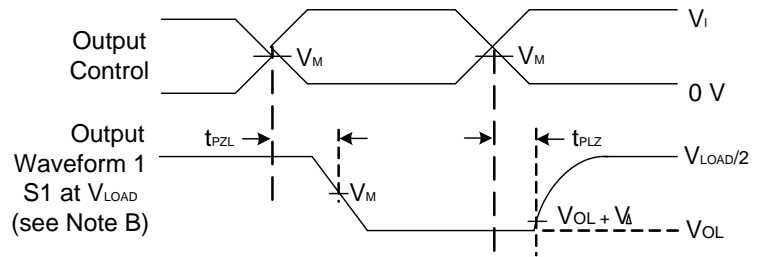
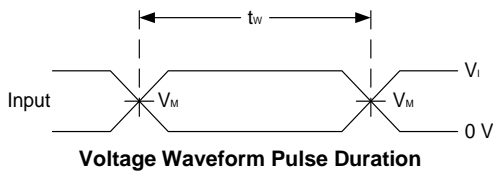

**Voltage Waveform Enable and Disable Times
Low and High Level Enabling**

Figure 1. Load Circuit and Voltage Waveforms

- Notes:
- A. Includes test lead and test apparatus capacitance.
 - B. All pulses are supplied at pulse repetition rate $\leq 10MHz$.
 - C. The input is one transition per measurement.
 - D. For the open drain device t_{PLZ} and t_{PZL} are the same as t_{PD} .
 - E. t_{PZL} is measured at V_M .
 - F. t_{PLZ} is measured at $V_{OL} + V_{\Delta}$.

Ordering Information (Note 8)

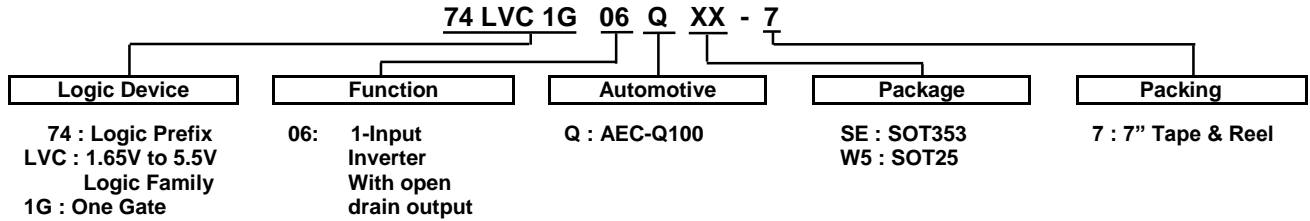

Part Number	Package Code	Package (Notes 9 & 10)	Package Size	7" Tape and Reel	
				Quantity	Part Number Suffix
74LVC1G06QSE-7	SE	SOT353	2.15mm × 2.1mm × 1.1mm 0.65mm lead pitch	3000/Tape & Reel	-7
74LVC1G06QW5-7	W5	SOT25	3.0mm × 2.8mm × 1.2mm 0.95mm lead pitch	3000/Tape & Reel	-7

Notes: 8. For packaging details, go to our website at <https://www.diodes.com/design/support/packaging/diodes-packaging/>.
 9. Pad layout as shown in Diodes Incorporated's package outline PDFs, which can be found on our website at <http://www.diodes.com/package-outlines.html>.
 10. The taping orientation is located on our website at <https://www.diodes.com/assets/Packaging-Support-Docs/ap02007.pdf>.

Marking Information

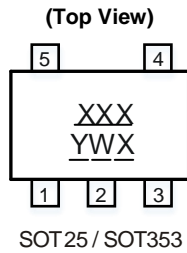

XXX : Identification Code
Y : Year 0~9
W : Week: A~Z 1~26 week
 a~z 27~52 week
 z represents week 52 and 53
X : A~ Z: Internal Code

Part Number	Package	Identification Code
74LVC1G06QW5-7	SOT25	UMQ
74LVC1G06QSE-7	SOT353	UMQ

Package Outline Dimensions

Please see <http://www.diodes.com/package-outlines.html> for the latest version.

(1) Package Type: SOT25



SOT25			
Dim	Min	Max	Typ
A	0.35	0.50	0.38
B	1.50	1.70	1.60
C	2.70	3.00	2.80
D	-	-	0.95
H	2.90	3.10	3.00
J	0.013	0.10	0.05
K	1.00	1.30	1.10
L	0.35	0.55	0.40
M	0.10	0.20	0.15
N	0.70	0.80	0.75
α	0°	8°	-
All Dimensions in mm			

(2) Package Type: SOT353

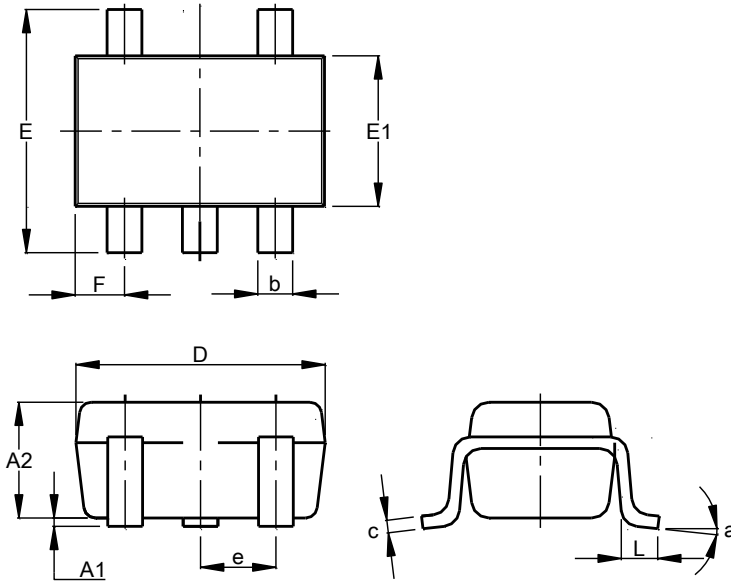

SOT353			
Dim	Min	Max	Typ
A1	0.00	0.10	0.05
A2	0.90	1.00	0.95
b	0.10	0.30	0.25
c	0.10	0.22	0.11
D	1.80	2.20	2.15
E	2.00	2.20	2.10
E1	1.15	1.35	1.30
e	0.650 BSC		
F	0.40	0.45	0.425
L	0.25	0.40	0.30
a	0°	8°	--
All Dimensions in mm			

Suggested Pad Layout

Please see <http://www.diodes.com/package-outlines.html> for the latest version.

(1) Package Type: SOT25

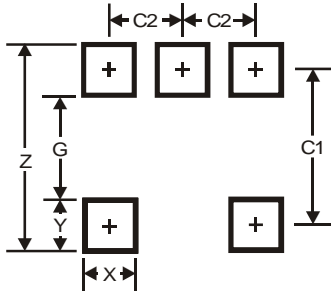

Dimensions	Value
Z	3.20
G	1.60
X	0.55
Y	0.80
C1	2.40
C2	0.95

(2) Package Type: SOT353



Dimensions	Value (in mm)
C	0.650
C1	1.900
G	1.300
X	0.420
X1	1.720
Y	0.600
Y1	2.500

Mechanical Data

SOT25

- Moisture Sensitivity: Level 1 per J-STD-020
- Terminals: Finish – Matte Tin Plated Leads, Solderable per MIL-STD-202, Method 208@3
- Weight: 0.0158 grams (Approximate)

SOT353

- Moisture Sensitivity: Level 1 per J-STD-020
- Terminals: Finish – Matte Tin Plated Leads, Solderable per MIL-STD-202, Method 208@3
- Weight: 0.0064 grams (Approximate)