

74VHC14; 74VHCT14

Hex inverting Schmitt trigger

Rev. 01 — 17 August 2009

Product data sheet

1. General description

The 74VHC14; 74VHCT14 are a high-speed Si-gate CMOS devices and are pin compatible with Low-power Schottky TTL (LSTTL). They are specified in compliance with JEDEC standard No. 7A.

The 74VHC14; 74VHCT14 provide six inverting buffers with Schmitt-trigger action. They are capable of transforming slowly changing input signals into sharply defined, jitter-free output signals.

2. Features

- Balanced propagation delays
- All inputs have Schmitt-trigger action
- Inputs accept voltages higher than V_{CC}
- Input levels:
 - ◆ The 74VHC14 operates with CMOS input level
 - ◆ The 74VHCT14 operates with TTL input level
- ESD protection:
 - ◆ HBM EIA/JESD22-A114E exceeds 2000 V
 - ◆ MM EIA/JESD22-A115-A exceeds 200 V
 - ◆ CDM EIA/JESD22-C101C exceeds 1000 V
- Multiple package options
- Specified from $-40\text{ }^{\circ}\text{C}$ to $+85\text{ }^{\circ}\text{C}$ and from $-40\text{ }^{\circ}\text{C}$ to $+125\text{ }^{\circ}\text{C}$

3. Ordering information

Table 1. Ordering information

Type number	Package			Version
	Temperature range	Name	Description	
74VHC14D 74VHCT14D	-40 °C to +125 °C	SO14	plastic small outline package; 14 leads; body width 3.9 mm	SOT108-1
74VHC14PW 74VHCT14PW	-40 °C to +125 °C	TSSOP14	plastic thin shrink small outline package; 14 leads; body width 4.4 mm	SOT402-1
74VHC14BQ 74VHCT14BQ	-40 °C to +125 °C	DHVQFN14	plastic dual in-line compatible thermal enhanced very thin quad flat package; no leads; 14 terminals; body 2.5 × 3 × 0.85 mm	SOT762-1

4. Functional diagram

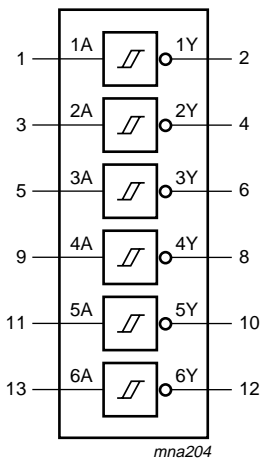

Fig 1. Logic symbol

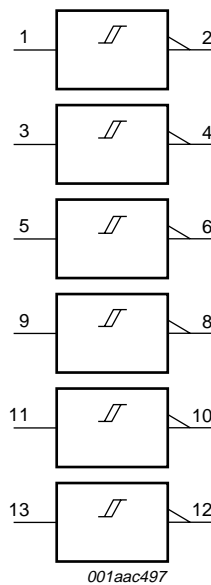

Fig 2. IEC logic symbol

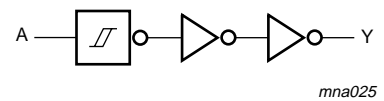
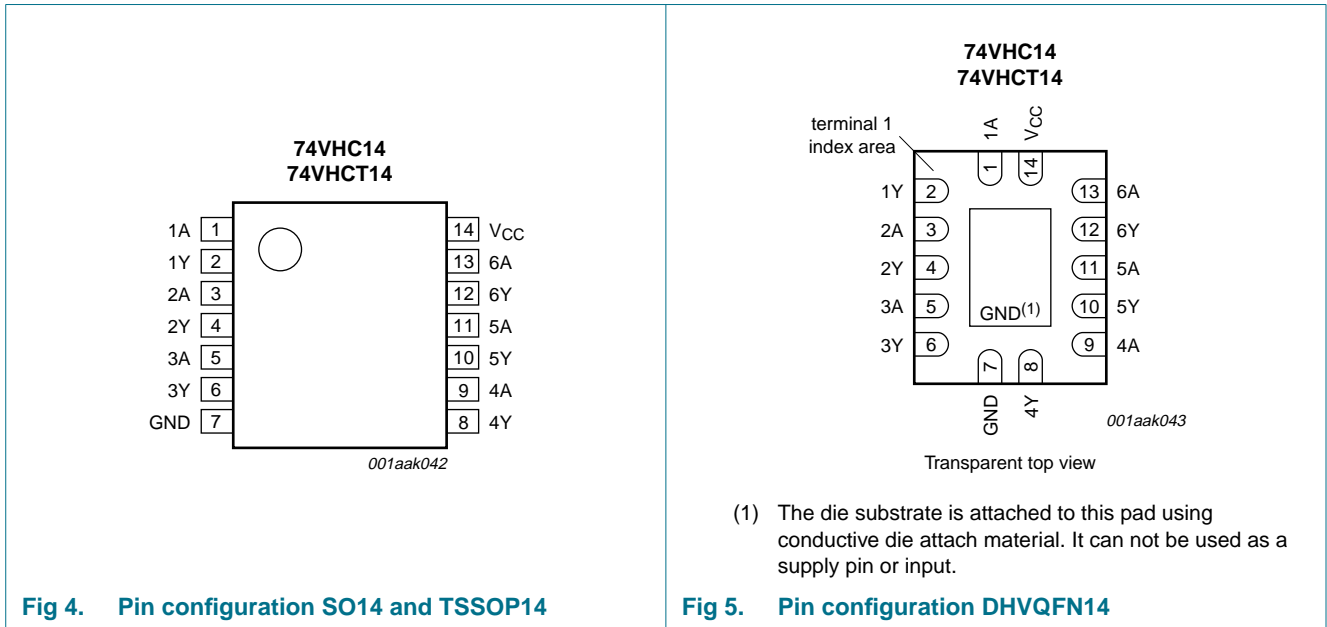

Fig 3. Logic diagram (one Schmitt-trigger)

5. Pinning information

5.1 Pinning



5.2 Pin description

Table 2. Pin description

Symbol	Pin	Description
1A	1	data input 1
1Y	2	data output 1
2A	3	data input 2
2Y	4	data output 2
3A	5	data input 3
3Y	6	data output 3
GND	7	ground (0 V)
4Y	8	data output 4
4A	9	data input 4
5Y	10	data output 5
5A	11	data input 5
6Y	12	data output 6
6A	13	data input 6
V _{CC}	14	supply voltage

6. Functional description

Table 3. Function table^[1]

Input	Output
nA	nY
L	H
H	L

- [1] H = HIGH voltage level;
L = LOW voltage level.

7. Limiting values

Table 4. Limiting values

In accordance with the Absolute Maximum Rating System (IEC 60134). Voltages are referenced to GND (ground = 0 V).

Symbol	Parameter	Conditions	Min	Max	Unit
V_{CC}	supply voltage		-0.5	+7.0	V
V_I	input voltage		-0.5	+7.0	V
I_{IK}	input clamping current	$V_I < -0.5$ V	^[1] -20	-	mA
I_{OK}	output clamping current	$V_O < -0.5$ V or $V_O > V_{CC} + 0.5$ V	^[1] -20	+20	mA
I_O	output current	$V_O = -0.5$ V to $(V_{CC} + 0.5)$ V	-25	+25	mA
I_{CC}	supply current		-	+75	mA
I_{GND}	ground current		-75	-	mA
T_{stg}	storage temperature		-65	+150	°C
P_{tot}	total power dissipation	$T_{amb} = -40$ °C to +125 °C	^[2] -	500	mW

- [1] The input and output voltage ratings may be exceeded if the input and output current ratings are observed.

- [2] For SO14 packages: above 70 °C the value of P_{tot} derates linearly at 8 mW/K.
For TSSOP14 packages: above 60 °C the value of P_{tot} derates linearly at 5.5 mW/K.
For DHVQFN14 packages: above 60 °C the value of P_{tot} derates linearly at 4.5 mW/K.

8. Recommended operating conditions

Table 5. Operating conditions

Symbol	Parameter	Conditions	Min	Typ	Max	Unit
74VHC14						
V_{CC}	supply voltage		2.0	5.0	5.5	V
V_I	input voltage		0	-	5.5	V
V_O	output voltage		0	-	V_{CC}	V
T_{amb}	ambient temperature		-40	+25	+125	°C
74VHCT14						
V_{CC}	supply voltage		4.5	5.0	5.5	V
V_I	input voltage		0	-	5.5	V
V_O	output voltage		0	-	V_{CC}	V
T_{amb}	ambient temperature		-40	+25	+125	°C

9. Static characteristics

Table 6. Static characteristics
At recommended operating conditions; voltages are referenced to GND (ground = 0 V).

Symbol	Parameter	Conditions	25 °C			-40 °C to +85 °C		-40 °C to +125 °C		Unit
			Min	Typ	Max	Min	Max	Min	Max	
74VHC14										
V _{OH}	HIGH-level output voltage	V _I = V _{T+} or V _{T-}								
		I _O = -50 μA; V _{CC} = 2.0 V	1.9	2.0	-	1.9	-	1.9	-	V
		I _O = -50 μA; V _{CC} = 3.0 V	2.9	3.0	-	2.9	-	2.9	-	V
		I _O = -50 μA; V _{CC} = 4.5 V	4.4	4.5	-	4.4	-	4.4	-	V
		I _O = -4.0 mA; V _{CC} = 3.0 V	2.58	-	-	2.48	-	2.40	-	V
		I _O = -8.0 mA; V _{CC} = 4.5 V	3.94	-	-	3.80	-	3.70	-	V
V _{OL}	LOW-level output voltage	V _I = V _{T+} or V _{T-}								
		I _O = 50 μA; V _{CC} = 2.0 V	-	0	0.1	-	0.1	-	0.1	V
		I _O = 50 μA; V _{CC} = 3.0 V	-	0	0.1	-	0.1	-	0.1	V
		I _O = 50 μA; V _{CC} = 4.5 V	-	0	0.1	-	0.1	-	0.1	V
		I _O = 4.0 mA; V _{CC} = 3.0 V	-	-	0.36	-	0.44	-	0.55	V
		I _O = 8.0 mA; V _{CC} = 4.5 V	-	-	0.36	-	0.44	-	0.55	V
I _I	input leakage current	V _I = 5.5 V or GND; V _{CC} = 0 V to 5.5 V	-	-	0.1	-	1.0	-	2.0	μA
I _{CC}	supply current	V _I = V _{CC} or GND; I _O = 0 A; V _{CC} = 5.5 V	-	-	2.0	-	20	-	40	μA
C _I	input capacitance		-	3	10	-	10	-	10	pF
C _O	output capacitance		-	4	-	-	-	-	-	pF
74VHCT14										
V _{OH}	HIGH-level output voltage	V _I = V _{T+} or V _{T-}								
		I _O = -50 μA; V _{CC} = 4.5 V	4.4	4.5	-	4.4	-	4.4	-	V
		I _O = -8.0 mA; V _{CC} = 4.5 V	3.94	-	-	3.80	-	3.70	-	V
V _{OL}	LOW-level output voltage	V _I = V _{T+} or V _{T-}								
		I _O = 50 μA; V _{CC} = 4.5 V	-	0	0.1	-	0.1	-	0.1	V
		I _O = 8.0 mA; V _{CC} = 4.5 V	-	-	0.36	-	0.44	-	0.55	V
I _I	input leakage current	V _I = 5.5 V or GND; V _{CC} = 0 V to 5.5 V	-	-	0.1	-	1.0	-	2.0	μA
I _{CC}	supply current	V _I = V _{CC} or GND; I _O = 0 A; V _{CC} = 5.5 V	-	-	2.0	-	20	-	40	μA
ΔI _{CC}	additional supply current	per input pin; V _I = V _{CC} - 2.1 V; other pins at V _{CC} or GND; I _O = 0 A; V _{CC} = 4.5 V to 5.5 V	-	-	1.35	-	1.5	-	1.5	mA
C _I	input capacitance		-	3	10	-	10	-	10	pF
C _O	output capacitance		-	4	-	-	-	-	-	pF

10. Dynamic characteristics

Table 7. Dynamic characteristics

Voltages are referenced to GND (ground = 0 V); for test circuit see [Figure 7](#).

Symbol	Parameter	Conditions	25 °C			-40 °C to +85 °C		-40 °C to +125 °C		Unit
			Min	Typ ^[1]	Max	Min	Max	Min	Max	
74VHC14										
t_{pd}	propagation delay	nA to nY; see Figure 6 [2]								
		$V_{CC} = 3.0\text{ V to }3.6\text{ V}$								
		$C_L = 15\text{ pF}$	-	4.3	12.8	1.0	15.0	1.0	16.0	ns
		$C_L = 50\text{ pF}$	-	5.8	16.3	1.0	18.0	1.0	20.5	ns
		$V_{CC} = 4.5\text{ V to }5.5\text{ V}$								
		$C_L = 15\text{ pF}$	-	3.2	8.6	1.0	10.0	1.0	11.0	ns
		$C_L = 50\text{ pF}$	-	4.2	10.6	1.0	12.0	1.0	13.5	ns
C_{PD}	power dissipation capacitance	$f_i = 1\text{ MHz}; V_I = \text{GND to }V_{CC}$ [3]	-	10	-	-	-	-	-	pF
74VHCT14										
t_{pd}	propagation delay	nA to nY; see Figure 6 [2]								
		$V_{CC} = 4.5\text{ V to }5.5\text{ V}$								
		$C_L = 15\text{ pF}$	-	4.0	7.0	1.0	8.0	1.0	9.0	ns
		$C_L = 50\text{ pF}$	-	5.4	8.0	1.0	9.0	1.0	10.0	ns
C_{PD}	power dissipation capacitance	$f_i = 1\text{ MHz}; V_I = \text{GND to }V_{CC}$ [3]	-	12	-	-	-	-	-	pF

[1] Typical values are measured at nominal supply voltage ($V_{CC} = 3.3\text{ V}$ and $V_{CC} = 5.0\text{ V}$).

[2] t_{pd} is the same as t_{PLH} and t_{PHL} .

[3] C_{PD} is used to determine the dynamic power dissipation (P_D in μW).

$$P_D = C_{PD} \times V_{CC}^2 \times f_i \times N + \Sigma(C_L \times V_{CC}^2 \times f_o) \text{ where:}$$

f_i = input frequency in MHz;

f_o = output frequency in MHz;

C_L = output load capacitance in pF;

V_{CC} = supply voltage in V;

N = number of inputs switching;

$\Sigma(C_L \times V_{CC}^2 \times f_o)$ = sum of the outputs.

11. Waveforms

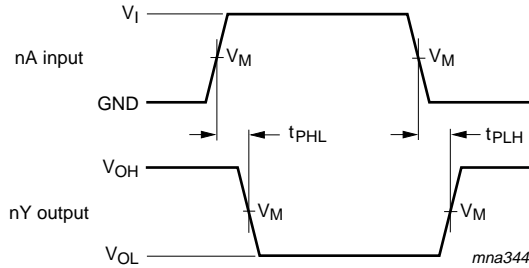

Measurement points are given in [Table 8](#).
 V_{OL} and V_{OH} are typical voltage output levels that occur with the output load.

Fig 6. Input to output propagation delays

Table 8. Measurement points

Type	Input	Output
	V_M	V_M
74VHC14	$0.5V_{CC}$	$0.5V_{CC}$
74VHCT14	1.5 V	$0.5V_{CC}$

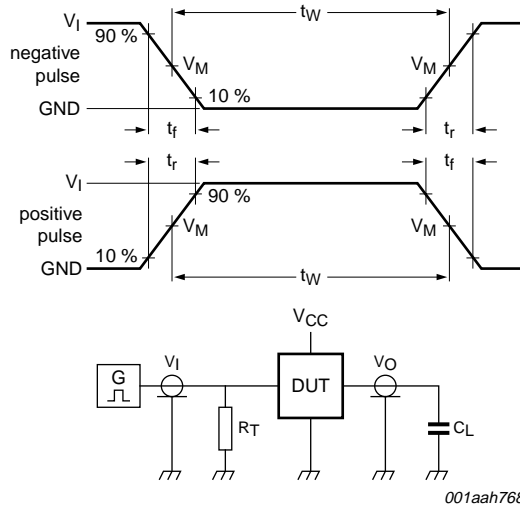

Test data is given in [Table 9](#).
 Definitions test circuit:
 R_T = Termination resistance should be equal to output impedance Z_o of the pulse generator
 C_L = Load capacitance including jig and probe capacitance

Fig 7. Load circuitry for measuring switching times

Table 9. Test data

Type	Input		Load	Test
	V_I	t_r, t_f	C_L	
74VHC14	V_{CC}	≤ 3.0 ns	50 pF, 15 pF	t_{PLH}, t_{PHL}
74VHCT14	3.0 V	≤ 3.0 ns	50 pF, 15 pF	t_{PLH}, t_{PHL}

12. Transfer characteristics

Table 10. Transfer characteristics

At recommended operating conditions; voltages are referenced to GND (ground = 0 V); see Figure 8 and Figure 9.

Symbol	Parameter	Conditions	25 °C			-40 °C to +85 °C		-40 °C to +125 °C		Unit
			Min	Typ	Max	Min	Max	Min	Max	
74VHC14										
V_{T+}	positive-going threshold voltage	$V_{CC} = 3.0$ V	-	-	2.2	-	2.2	-	2.2	V
		$V_{CC} = 4.5$ V	-	-	3.15	-	3.15	-	3.15	V
		$V_{CC} = 5.5$ V	-	-	3.85	-	3.85	-	3.85	V
V_{T-}	negative-going threshold voltage	$V_{CC} = 3.0$ V	0.9	-	-	0.9	-	0.9	-	V
		$V_{CC} = 4.5$ V	1.35	-	-	1.35	-	1.35	-	V
		$V_{CC} = 5.5$ V	1.65	-	-	1.65	-	1.65	-	V
V_H	hysteresis voltage	$V_{CC} = 3.0$ V	0.3	-	1.2	0.3	1.2	0.25	1.2	V
		$V_{CC} = 4.5$ V	0.4	-	1.4	0.4	1.4	0.35	1.4	V
		$V_{CC} = 5.5$ V	0.5	-	1.6	0.5	1.6	0.45	1.6	V
74VHCT14										
V_{T+}	positive-going threshold voltage	$V_{CC} = 4.5$ V	-	-	1.9	-	1.9	-	1.9	V
		$V_{CC} = 5.5$ V	-	-	2.1	-	2.1	-	2.1	V
V_{T-}	negative-going threshold voltage	$V_{CC} = 4.5$ V	0.5	-	-	0.5	-	0.5	-	V
		$V_{CC} = 5.5$ V	0.6	-	-	0.6	-	0.6	-	V
V_H	hysteresis voltage	$V_{CC} = 4.5$ V	0.4	-	1.4	0.4	1.4	0.35	1.4	V
		$V_{CC} = 5.5$ V	0.4	-	1.5	0.4	1.5	0.35	1.5	V

13. Transfer characteristics waveforms

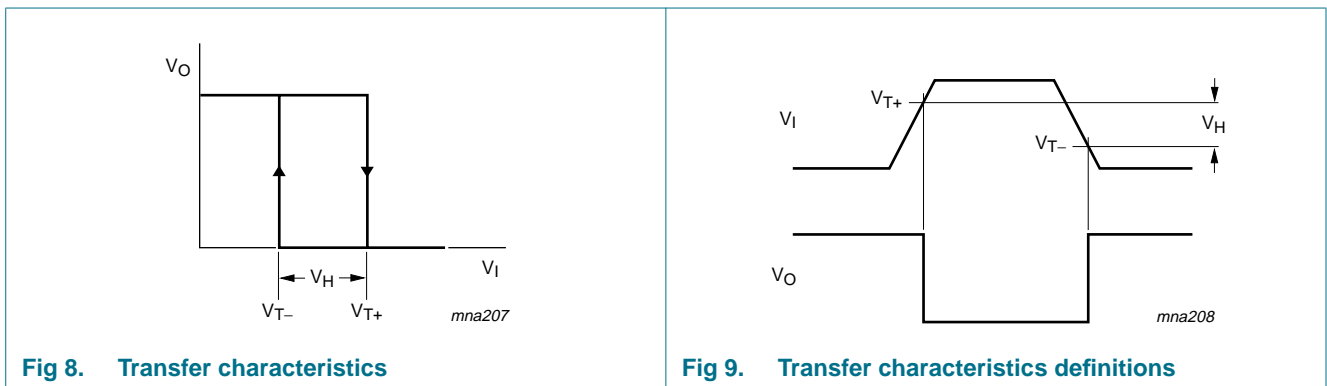

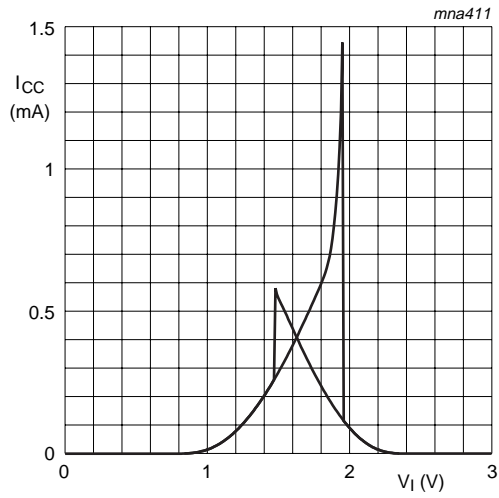

a. $V_{CC} = 3.0\text{ V}$

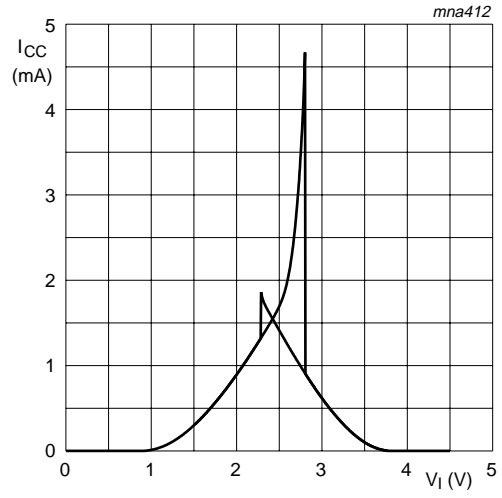

b. $V_{CC} = 4.5\text{ V}$

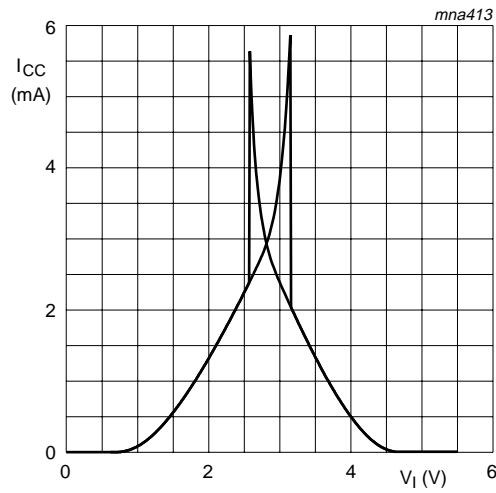

c. $V_{CC} = 5.5\text{ V}$

Fig 10. Typical 74VHC transfer characteristics

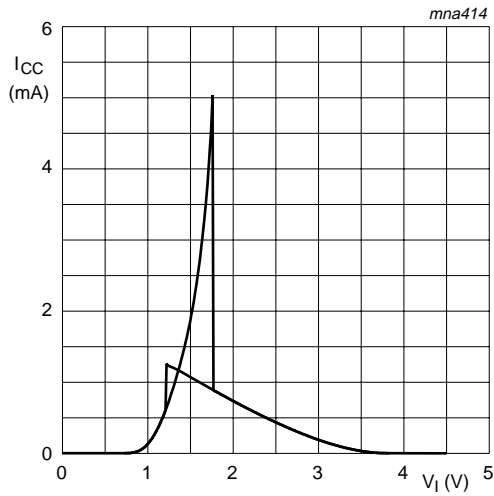

a. $V_{CC} = 4.5 \text{ V}$

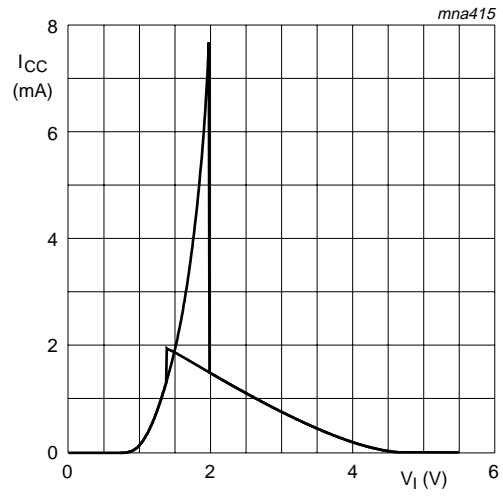

b. $V_{CC} = 5.5 \text{ V}$

Fig 11. Typical 74VHCT transfer characteristics

14. Application information

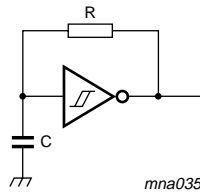

For 74VHC14: $f = \frac{1}{T} \approx \frac{1}{0.55 \times RC}$

For 74VHCT14: $f = \frac{1}{T} \approx \frac{1}{0.60 \times RC}$

Fig 12. Relaxation oscillator

15. Package outline

SO14: plastic small outline package; 14 leads; body width 3.9 mm

SOT108-1

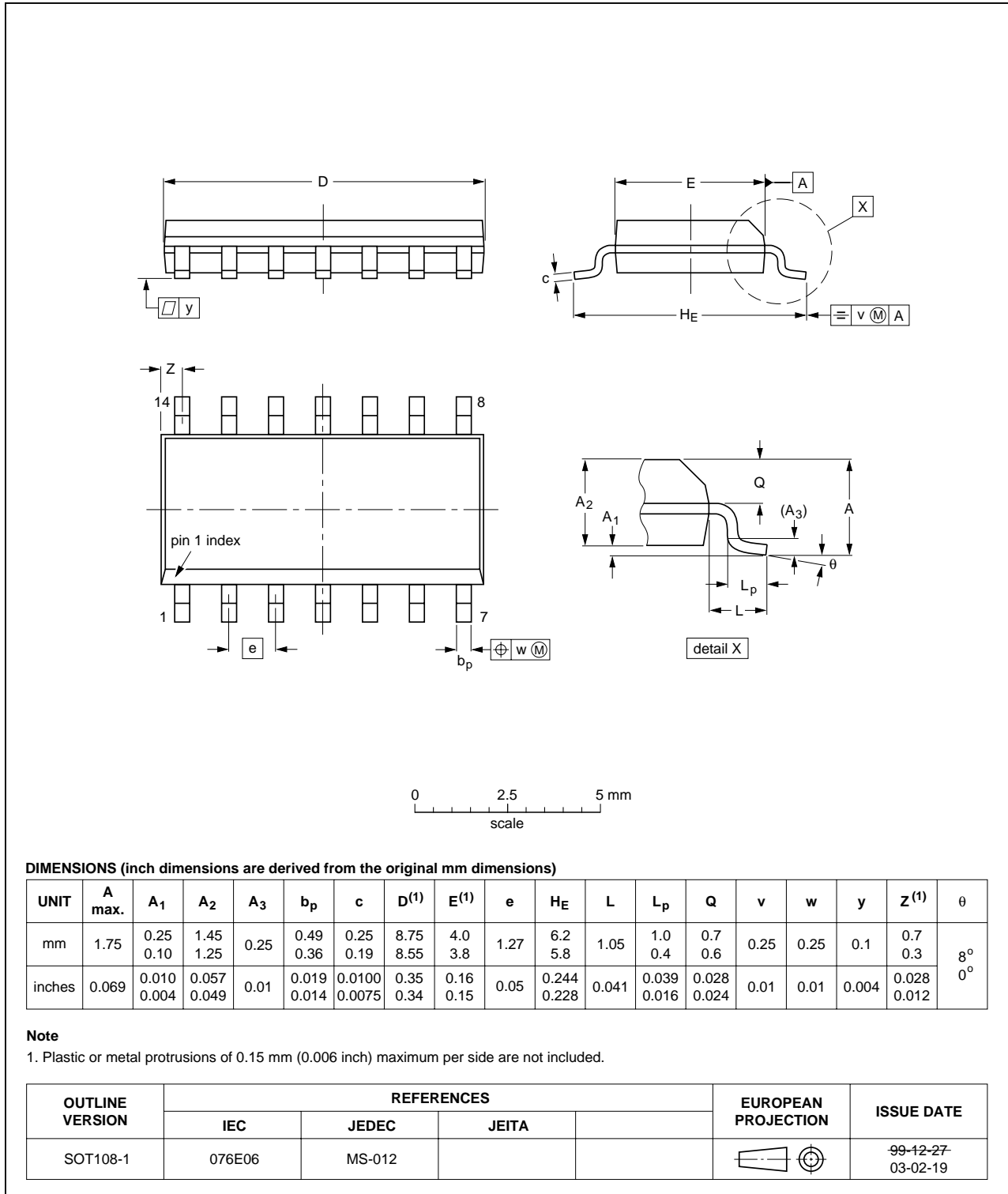

Fig 13. Package outline SOT108-1 (SO14)

TSSOP14: plastic thin shrink small outline package; 14 leads; body width 4.4 mm

SOT402-1

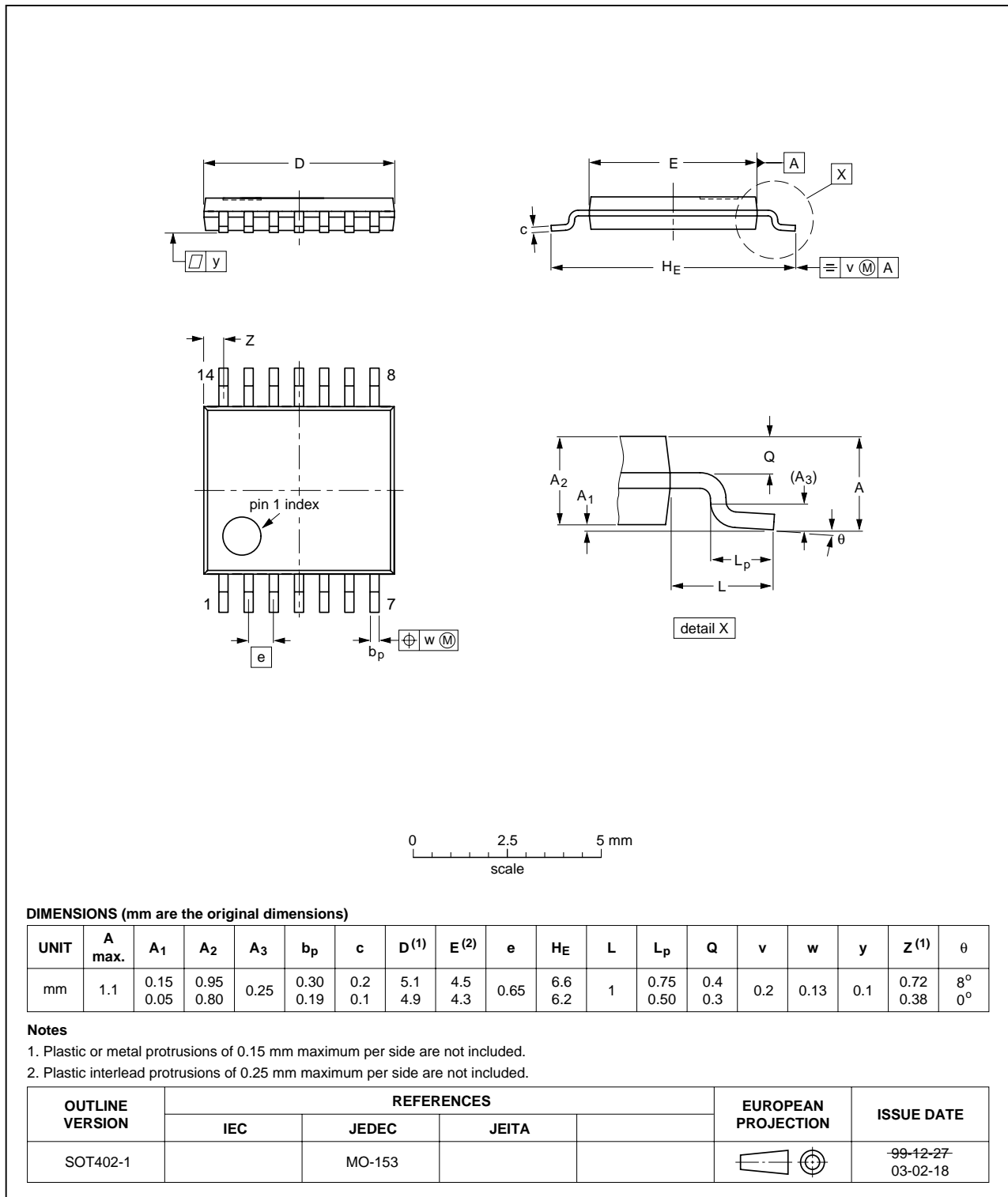

Fig 14. Package outline SOT402-1 (TSSOP14)

DHVQFN14: plastic dual in-line compatible thermal enhanced very thin quad flat package; no leads; 14 terminals; body 2.5 x 3 x 0.85 mm

SOT762-1

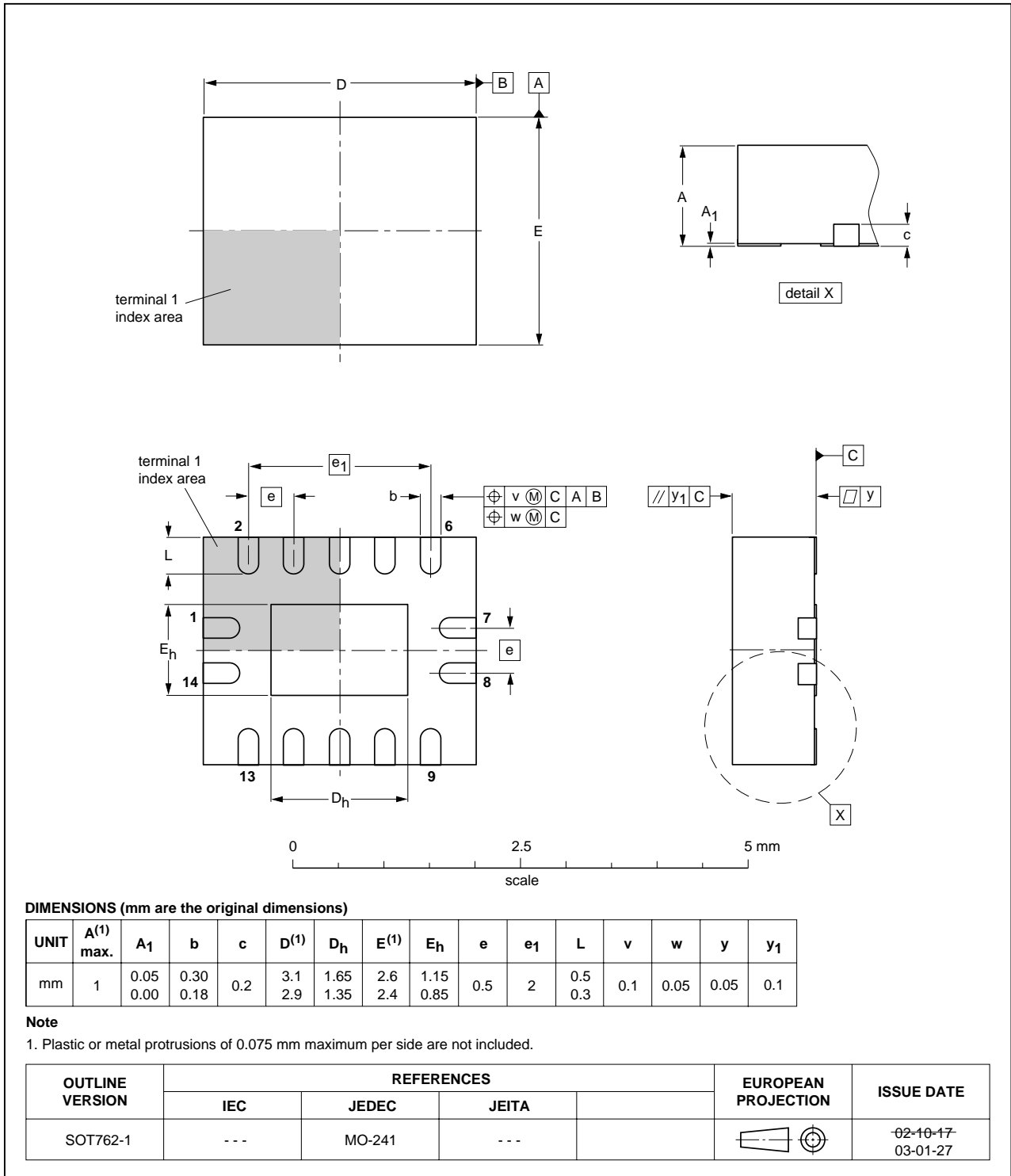

Fig 15. Package outline SOT762-1 (DHVQFN14)

16. Abbreviations

Table 11. Abbreviations

Acronym	Description
CDM	Charged Device Model
CMOS	Complementary Metal-Oxide Semiconductor
DUT	Device Under Test
ESD	ElectroStatic Discharge
HBM	Human Body Model
LSTTL	Low-power Schottky Transistor-Transistor Logic
MM	Machine Model

17. Revision history

Table 12. Revision history

Document ID	Release date	Data sheet status	Change notice	Supersedes
74VHC_VHCT14_1	20090817	Product data sheet	-	-

18. Legal information

18.1 Data sheet status

Document status ^{[1][2]}	Product status ^[3]	Definition
Objective [short] data sheet	Development	This document contains data from the objective specification for product development.
Preliminary [short] data sheet	Qualification	This document contains data from the preliminary specification.
Product [short] data sheet	Production	This document contains the product specification.

[1] Please consult the most recently issued document before initiating or completing a design.

[2] The term 'short data sheet' is explained in section "Definitions".

[3] The product status of device(s) described in this document may have changed since this document was published and may differ in case of multiple devices. The latest product status information is available on the Internet at URL <http://www.nexperia.com>.

18.2 Definitions

Draft — The document is a draft version only. The content is still under internal review and subject to formal approval, which may result in modifications or additions. Nexperia does not give any representations or warranties as to the accuracy or completeness of information included herein and shall have no liability for the consequences of use of such information.

Short data sheet — A short data sheet is an extract from a full data sheet with the same product type number(s) and title. A short data sheet is intended for quick reference only and should not be relied upon to contain detailed and full information. For detailed and full information see the relevant full data sheet, which is available on request via the local Nexperia sales office. In case of any inconsistency or conflict with the short data sheet, the full data sheet shall prevail.

18.3 Disclaimers

General — Information in this document is believed to be accurate and reliable. However, Nexperia does not give any representations or warranties, expressed or implied, as to the accuracy or completeness of such information and shall have no liability for the consequences of use of such information.

Right to make changes — Nexperia reserves the right to make changes to information published in this document, including without limitation specifications and product descriptions, at any time and without notice. This document supersedes and replaces all information supplied prior to the publication hereof.

Suitability for use — Nexperia products are not designed, authorized or warranted to be suitable for use in medical, military, aircraft, space or life support equipment, nor in applications where failure or malfunction of a Nexperia product can reasonably be expected to result in personal injury, death or severe property or environmental

damage. Nexperia accepts no liability for inclusion and/or use of Nexperia products in such equipment or applications and therefore such inclusion and/or use is at the customer's own risk.

Applications — Applications that are described herein for any of these products are for illustrative purposes only. Nexperia makes no representation or warranty that such applications will be suitable for the specified use without further testing or modification.

Limiting values — Stress above one or more limiting values (as defined in the Absolute Maximum Ratings System of IEC 60134) may cause permanent damage to the device. Limiting values are stress ratings only and operation of the device at these or any other conditions above those given in the Characteristics sections of this document is not implied. Exposure to limiting values for extended periods may affect device reliability.

Terms and conditions of sale — Nexperia products are sold subject to the general terms and conditions of commercial sale, as published at <http://www.nexperia.com/profile/terms>, including those pertaining to warranty, intellectual property rights infringement and limitation of liability, unless explicitly otherwise agreed to in writing by Nexperia. In case of any inconsistency or conflict between information in this document and such terms and conditions, the latter will prevail.

No offer to sell or license — Nothing in this document may be interpreted or construed as an offer to sell products that is open for acceptance or the grant, conveyance or implication of any license under any copyrights, patents or other industrial or intellectual property rights.

Export control — This document as well as the item(s) described herein may be subject to export control regulations. Export might require a prior authorization from national authorities.

18.4 Trademarks

Notice: All referenced brands, product names, service names and trademarks are the property of their respective owners.

19. Contact information

For more information, please visit: <http://www.nexperia.com>

For sales office addresses, please send an email to: salesaddresses@nexperia.com