

# PRESSURE SWITCHES

50094081

Issue 6

HP, HE, MH, ME, LP, LE, 5000, and 1000 Series



## DESCRIPTION

The Honeywell Pressure Switch portfolio consists of:

- High Pressure (HE/HP Series)
- Medium Pressure (ME/MH Series)
- Low Pressure (LE/LP Series)
- 5000 Series, 1000 Series

These pressure switches are durable, reliable electromechanical gauge pressure on/off switches that are available with either single pole single throw (SPST) normally open or normally closed circuitry, or single pole double throw (SPDT) circuitry. Their high proof pressure and burst pressure ratings can allow for use in many rugged applications that require the making or breaking of an electrical connection in response to a pressure change of the system media.

## DIFFERENTIATION

- **Through optional smart diagnostic technology, Honeywell pressure switches are able to detect failures such as open circuits, cut wires, worn insulation, and more<sup>6</sup>**
- Optional smart diagnostic technology allows up to four segregated signal amplitudes to perform diagnostics and status<sup>6</sup>
- Pressure port snubber suppresses pressure spikes<sup>2</sup>
- IP67 sealing provides enhanced durability in harsh environmental and washing applications<sup>1</sup>

## VALUE TO CUSTOMERS

- Designed to provide resistance to corrosion and enhances equipment life with available two million life cycle rating and IP67 rating<sup>1</sup>
- Can expedite design and product cycle due to ability to receive samples in two weeks and production units in four weeks
- Can reduce tooling, service, and manufacturing labor costs due to standard connections, extended product life, and expedited design and production cycle

## FEATURES

- Pressure switching set point range: 3.5 psi to 4500 psi
- Proof pressure: from 500 psi up to 10,000 psi
- Burst pressure: from 1250 psi up to 20,000 psi
- Life cycle rating up to 2 million
- IP67 sealing rating<sup>4</sup>
- Operating temperature: -40°C to 120°C [-40°F to 248°F]
- Hysteresis option<sup>5</sup>
- More than 15 pressure port options and over 30 electrical terminations
- Plated steel, brass or stainless steel options<sup>3</sup>
- Switching point accuracy up to  $\pm 2\%$

## POTENTIAL APPLICATIONS



- Agricultural machinery
- Heavy duty construction machinery and trucks
- Lawn & garden machinery
- Marine vessels
- Material handling machinery
- Railway
- CNC machines
- Compressors/boilers
- Fracking equipment
- Food & beverage equipment
- Generators
- HVAC/R equipment
- Mud pumps
- Pneumatic equipment
- Presses/punches
- Pressure washers
- Trash compactors
- Water pumps & jet cutting machines

## PORTFOLIO

Honeywell also offers the [PBN1 Series](#) and [PBN3 Series](#) Pressure Sensor.

<sup>1</sup> HP, HE, MH, ME, LP, LE Series

<sup>2</sup> HP, HE Series

<sup>3</sup> ME, LP, LE Series

<sup>4</sup> HP, HE, LP, LE, ME Series

<sup>5</sup> HP, HE, LP Series

<sup>6</sup> HP, HE, ME, LP, LE Series

**Honeywell**

# PRESSURE SWITCHES, HP, HE, MH, ME, LP, LE, 5000, 1000 SERIES

**TABLE 1. SPECIFICATIONS**

Characteristic	HP Series	HE Series	ME Series	MH Series	LP Series	LE Series	5000 Series	1000 Series
Product length (various terminations)	see pages 5 and 6	see page 5	see page 8	see page 7	see page 9	see page 9	see page 10	-
Product length (blade)	see pages 5 and 6	see page 5	see page 8	see page 7	see page 9	see page 9	58,42 mm [2.3 in]	65,6 mm [2.583 in]
Product length (#8-32 screws)	see pages 5 and 6	see page 5	see page 8	see page 7	see page 9	see page 9	60,96 mm [2.4 in]	-
Product length (Metripack)	see pages 5 and 6	see page 5	see page 8	see page 7	see page 9	see page 9	73,66 mm [2.9 in]	-
Hex size	27 mm	27 mm	27 mm	27 mm	27 mm	27 mm	0.50 in (steel) 0.437 in (brass)	M10 x 1.25 banjo fitting
Ease of installation	box spanner	box spanner	box spanner	box spanner	box spanner	box spanner	1/2 in open spanner	18 mm open spanner
Snap-action switch	yes	yes	no	no	yes	no	no	no
Set point <sup>1</sup> range	100 psi to 4500 psi	150 psi to 4500 psi	25 psi to 350 psi	40 psi to 500 psi	3.5 psi to 150 psi	3.5 psi to 150 psi	75 psi to 150 psi	10 psi to 60 psi [0,69 bar to 2,7 bar]
Set point ranges	6 (Base Style A) 7 (Base Style B)	6	4	4	4	4	8	-
Set point accuracy @ 25°C (before test)	100 psi to 150 psi (±10 %); 150 psi to 500 psi (±6 %); 501 psi to 4000 psi (±3.5 %); 4000 psi to 4500 psi (±2 %)	150 psi to 1000 psi (±14 %); 1000 psi to 2000 psi (±12 %); 2000 psi to 4000 psi (±11 %); >4000 psi (±10 %)	25 psi to 50 psi (±3 psi); >50 psi to 100 psi (±7 psi); >100 psi to 150 psi (±10 psi); >150 psi to 250 psi (±13 psi); >250 psi to 350 psi (±16 psi)	40 psi to 70 psi (±7 psi); >70 psi to 130 psi (±10 psi); >130 psi to 200 psi (±15 psi); >200 psi to 280 psi (±20 psi); >280 psi to 350 psi (±30 psi); >350 psi to 500 psi (±40 psi)		3.5 psi to 10 psi (±1 psi); >10 psi to 50 psi (±3 psi); >50 psi to 100 psi (±7 psi); >100 psi to 150 psi (±10 psi)	0.5 psi to 1 psi (±0.3 psi); 1.1 psi to 3 psi (±0.5 psi); 3.1 psi to 7 psi (±1 psi); 8 psi to 13 psi (±3 psi); 14 psi to 24 psi (±3 psi); 25 psi to 50 psi (±5 psi); 51 psi to 90 psi (±7 psi); 91 psi to 150 psi (±10 psi)	20 psi ±10 psi; 58 psi ±20 psi
Average dead-band max.	n/a	n/a	25 psi to 50 psi (20 psi); >50 psi to 100 psi (30 psi); >100 psi to 150 psi (40 psi); >150 psi to 250 psi (50 psi); >250 psi to 350 psi (60 psi)	40 psi to 70 psi (±6 psi); >70 psi to 130 psi (±10 psi); >130 psi to 200 psi (±15 psi); >200 psi to 280 psi (±20 psi); >280 psi to 350 psi (±30 psi); >350 psi to 500 psi (±40 psi)	n/a	3.5 psi to 10 psi (±2.8 psi); >10 psi to 50 psi (±14 psi); >50 psi to 100 psi (±38 psi); >100 psi to 150 psi (±40 psi)	0.5 psi to 3 psi (±1.5 psi); 4 psi to 7 psi (±2.5 psi); 8 psi to 13 psi (±3.5 psi); 14 psi to 24 psi (±8 psi); 25 psi to 50 psi (±15 psi); 51 psi to 90 psi (±23 psi); 91 psi to 150 psi (±40 psi)	n/a
Operating pressure <sup>2</sup>	5,000 psi max.	5,000 psi max.	500 psi max.	600 psi max.	250 psi max.	250 psi max.	150 psi, 250 psi	1400 psi [96,5 bar] max.
Proof pressure <sup>3</sup>	10,000 psi (Base Style A) 6,500 psi (Base Style B)	10,000 psi	4,000 psi	6,000 psi	500 psi	500 psi	500 psi	2973 psi [205 bar]
Hysteresis	5 % to 55 % (based on set point range)	3 % to 65 % (based on set point range)	n/a	n/a	5 % to 55 % (based on set point range)	n/a	n/a	n/a
Burst pressure <sup>4</sup>	20,000 psi (Base Style A); 9,000 psi (Base Style B)	20,000 psi	8,000 psi	9,000 psi	1250 psi	1250 psi	4000 psi	3500 psi [241 bar]
Current rating (resistive)	5 A at 250 Vac 5 A at 24 Vdc	3 A at 250 Vac 3 A at 24 Vdc	7.5 mA to 3 A, 24 Vdc and 250 Vac	100 mA to 3 A max.	7.5 mA to 5 A, 24 Vdc and 250 Vac	7.5 mA to 3 A, 24 Vdc and 250 Vac	15 A, 6 Vdc; 8 A, 12 Vdc; 4 A, 24 Vdc	12 Vdc with two-1157 bulbs (4.4 A)
Current rating (inductive)	5 A at 115 Vac (SX rating); 3 A at 28 Vdc	n/a	n/a	n/a	1 A at 28 Vdc	n/a	1 A, 120 Vac 0.5 A, 240 Vac	n/a

<sup>1</sup>Port Style C: Switches less than 975 psi will use Base Style B; switches greater than 975 psi will use Base Style A.

Port Styles F and G: Switches less than 350 psi will use Base Style B; switches greater than 350 psi will use Base Style A.

Port Styles A, B, E, M, P, T, and Y will use Base Style B.

Switches less than 150 psi will only use Base Style B.

# PRESSURE SWITCHES, HP, HE, MH, ME, LP, LE, 5000, 1000 SERIES

**TABLE 1. SPECIFICATIONS**

Characteristic	HP Series	HE Series	ME Series	MH Series	LP Series	LE Series	5000 Series	1000 Series
Rated thermal current	5 A	3 A	3 A	n/a	5 A	3 A	n/a	n/a
Rated insulation voltage	28 V	28 V	28 V	n/a	28 V	28 V	n/a	n/a
Short-circuit protective device c-type max. rating	Class J fuse (10 A, 600 V)			n/a	Class J fuse (10 A, 600 V)		n/a	n/a
Conditional short circuit current	1000 A			n/a	1000 A	1000 A	n/a	n/a
Pollution degree	3 (macro environment)			n/a	3 (macro environment)		n/a	n/a
Temperature rating	-40°C to 120°C [-40°F to 248°F]	-40°C to 85°C [-40°F to 185°F]	-40°C to 120°C [-40°F to 248°F]				-40°C to 121°C [-40°F to 250°F]	-20°C to 74°C [-4°F to 165°F]
Media connection	multiple ports available	multiple ports available	multiple ports available				1/8-27 NPT male thread	multiple ports available
Pressure ports	Refer to product nomenclature for pressure port types.	C = 1/2-20 UNF F = M14 × 1.5 G = 9/16-18 UNF H = 3/4-16 UNF K = M18 × 1.5 N = 7/8-14 UNF	A = 1/4-18 NPT B = 1/8-27 NPT C = 1/2-20 UNF D = 1/8-27 PTF E = M12 × 1.5 F = M14 × 1.5 G = 9/16-18 UNF H = 3/4-16 UNF J = G1/8 BSPP M = 7/16-20 UNF R = R1/8 BSPT T = M10 × 1.0 V = R1/2 BSPT Y = G1/4 BSPP Z = R1/4 BSPT	A = 1/4-18 NPT B = 1/8-27 NPT C = 1/2-20 UNF D = 1/8-27 PTF E = M12 × 1.5 F = M14 × 1.5 G = 9/16-18 UNF H = 3/4-16 UNF J = G1/8 BSPP L = 3/8-24 UNF M = 7/16-20 UNF P = 1/2-14 NPT R = R1/8 BSPT T = M10 × 1.0 V = R1/2 BSPT Y = G1/4 BSPP Z = R1/4 BSPT	A = 1/4-18 NPT B = 1/8-27 NPT C = 1/2-20 UNF D = 1/8-27 PTF E = M12 × 1.5 F = M14 × 1.5 G = 9/16-18 UNF H = 3/4-16 UNF J = G1/8 BSPP M = 7/16-20 UNF R = R1/8 BSPT T = M10 × 1.0 V = R1/2 BSPT Y = G1/4 BSPP Z = R1/4 BSPT	A = 1/4-18 NPT B = 1/8-27 NPT C = 1/2-20 UNF D = 1/8-27 PTF E = M12 × 1.5 F = M14 × 1.5 G = 9/16-18 UNF H = 3/4-16 UNF J = G1/8 BSPP M = 7/16-20 UNF R = R1/8 BSPT T = M10 × 1.0 V = R1/2 BSPT Y = G1/4 BSPP Z = R1/4 BSPT	1/8-27 NPT	M10 x 1.25 double banjo; M10 x 1; 1/8-27 NPT
Circuit forms <sup>5</sup>	SPDT, SPST - NO/NC		SPDT, SPST - NO/NC	SPST - NO/NC	SPDT, SPST - NO/NC	SPDT, SPST - NO/NC	SPST-NO; SPST-NC	SPNO
Smart pressure	single- or dual-resistor topology available			-	single- or dual-resistor topology available		-	-
Life	2 million (Base A) 1 million (Base B)	1 million	1 million	1 million	2 million	1 million	100,000 cycles	100,000 cycles
Agency approvals (special use switches)	-	-	-	-	-	-	UL Custom (select models)	-
Agency approvals (other)	CE	CE	CE	CE	CE	CE	-	-
Field adjustability <sup>6</sup>	no	no	yes	yes	yes	yes	yes	no
Spike dampening	yes	yes	no	no	no	no	no	no
Ingress protection <sup>7</sup>	IP67 (connectors) IP67 (wire/Base A) IP69K (wire/Base B) IP00 (blade/screw)	IP67 (connectors) IP00 (blade/screw)	IP67 (connectors) IP67 (wire out) IP00 (blade/screw)	IP67 (connectors) IP00 (blade/screw)	IP67 (connectors) IP67 (wire out) IP00 (blade/screw)	IP67 (connectors) IP67 (wire out) IP00 (blade/screw)	IP00	IP65
Vibration resistance	swept sine: 10 Hz to 2000 Hz at 15 g, 20 min/sweep; 8 hours in each axis random: 5 Hz to 2000 Hz, 8 hours/axis; 14.88 g-RMS, each axis						-	-
Shock resistance	500 m/sec <sup>2</sup> , 11 mSEC, 100 shocks / axis			500 m/sec <sup>2</sup> , 11 mSEC			-	15 G @ 5 mSEC
Wetted part (diaphragm)	n/a		Kapton <sup>®</sup> (Teflon <sup>®</sup> coated)	Nitrile/EPDM/LTNB	Kapton <sup>®</sup> (Teflon <sup>®</sup> coated)	Tefzel <sup>®</sup>	Polymide film	EPDM
Wetted part (piston)	nitrile o-ring, steel piston		nitrile or EPDM o-ring	nitrile or EPDM o-ring	nitrile or EPDM o-ring	nitrile or EPDM o-ring	nitrile or EPDM o-ring	EPDM
Weight	133 g [4.7 oz] (Base Style A) 178 g [6.28 oz] (Base Style B)		53 g [1.9 oz]	53 g [1.9 oz]	58 g [2.0 oz]	53 g [1.9 oz]	65 g [2.3 oz]	40 g [1.4 oz]
Contacts	silver / gold inlay	silver	gold plated	gold plated	gold plated	gold plated	silver-plated copper	silver-plated copper
Product finish	zinc plating	zinc plating	zinc plating	zinc plating	zinc plating	zinc plating	glass reinforced polyester (housing); plated steel (base)	Rynite 545 glass filled (housing); Trivalent plated steel (base)

<sup>1</sup>Set point: Point at which switch actuates or de-actuates

<sup>2</sup>Operating pressure: Maximum normal system operating pressure

<sup>3</sup>Proof pressure: Maximum pressure that the switch can handle while it maintains set point accuracy. Intermittent spikes to this level are acceptable.

<sup>4</sup>Burst pressure: Point of complete switch failure

<sup>5</sup>SPST: Single pole, single throw. SPDT: Single pole, double throw. NO: Normally open. NC: Normally closed.

<sup>6</sup>Field adjustability only available with AA, BA, CA, and DA (SPST only) terminations.

<sup>7</sup>IP00 for AA and BA terminations.

# PRESSURE SWITCHES, HP, HE, MH, ME, LP, LE, 5000, 1000 SERIES

**TABLE 2. TERMINATIONS**

Series	Available Terminations
HP, HE, ME, LP, LE	AA = Spade Terminals BA = Screw Terminals CA = Deutsch DT04-3P-E005 (3-Pin Connector) DA = Amp Super Seal 1.5 - 282105-1 (3-Pin Connector) EA = 10-inch Cable, 18 AWG (Wire Out, No Connector) FA = 10-inch Cable w/Deutsch DT04-3P-E005 (3-Pin Connector) (16 AWG)* GA = 10-inch Cable w/Amp Super Seal 1.5 - 282105-1 (3-Pin Connector) (18 AWG)* HA = 10-inch Cable w/Metripack 280 Delphi 15300002 (2-Pin Connector) (18 AWG)* JA = 10-inch Cable w/Din43650-C (3-Pin Connector) (18 AWG)* KA = 10-inch Cable w/M12x1 (Brad Harrison Micro) - 21032121306 Harting P/N (3-Pin Connector) (18 AWG)* LA = 10-inch Cable w/Packard Weatherpack Male Terminal - 12020827 (3-Pin Connector) (18 AWG)* MA = 10-inch Cable w/Deutsch DT04-2P-E005 (2-Pin Connector) (18 AWG) NA = 3-inch Cable w/Packard 2P Tower Connector - 12015792 (2-Pin Connector) (18 AWG) PA = 2.75-inch Cable w/Packard 2P Shroud Connector - 12010973 (2-Pin Connector) (18 AWG) RA = 4-inch Cable w/Packard 2P Shroud Connector - 12010973 (2-Pin Connector) (16 AWG) SA = 5.5-inch Cable w/ITT Cannon 2P Sure-Seal Circular Connector - SS2R-120-1804-000 (2-Pin Connector) (18 AWG) TA = 8.5-inch Cable w/ITT Cannon 3P Sure-Seal Circular Connector - SS3R-120-8551-001 (3-Pin Connector) (16 AWG)* UA = 10-inch Cable - Vacuum Impregnated w/Deutsch DT06-3S-EP06 (3-Socket Connector) (16 AWG)* VA = 10-inch Cable - Vacuum Impregnated w/Deutsch DT04-3P-E005 (3-Pin Connector) (16 AWG)* WA = 4.5-inch Cable w/Blade Terminals 6,3 mm x 0,8 mm (16 AWG)* XA = 10-inch Cable w/ Metripack 2-Pin Shroud Connector 153000027 (18 AWG) YA = 6-inch Cable w/Amp Super Seal 1.5 - 282104-1 (2-Pin Connector) (18 AWG)* ZA = 10-inch Cable w/Deutsch DT06-2S-CE06 (2-Socket Connector) (18 AWG) AB = Deutsch DT04-2P-E005 (2-Pin Connector) BB = 10-inch Cable w/Metripack 150 Delphi 12129615 (3-Pin Connector) (18 AWG)* CB = 6-inch Cable w/ AMP Super Seal 1.5 - 282080-1 (2-Pin Connector) (18 AWG) DB = 10-inch Cable w/AMP 2,5 mm System Series Connector 1-967402-1 (18 AWG)* EB = 4.5-inch Cable w/Packard Shroud Connector 12015792 (2-Pin Connector) (18 AWG) FB = 10-inch Cable w/Metripack 150 Delphi 12052641 (2-Pin Connector) (18 AWG) GB = 8.5-inch Cable w/Deutsch Plug HD 16-3 96S (3-Pin Connector) (16 AWG)
MH	AA = Spade Terminals BA = Screw Terminals DA = Amp Super Seal 1.5 - 282105-1 (3-Pin Connector) EA = 10-inch Cable, 18 AWG (Wire Out, No Connector) HA = 10-inch Cable w/Metripack 280 Delphi 15300002 (2-Pin Connector) (18 AWG)* MA = 10-inch Cable w/Deutsch DT04-2P-E005 (2-Pin Connector) (18 AWG) NA = 3-inch Cable w/Packard 2P Tower Connector - 12015792 (2-Pin Connector) (18 AWG) PA = 2.75-inch Cable w/Packard 2P Shroud Connector - 12010973 (2-Pin Connector) (18 AWG) RA = 4-inch Cable w/Packard 2P Shroud Connector - 12010973 (2-Pin Connector) (16 AWG) SA = 5.5-inch Cable w/ITT Cannon 2P Sure-Seal Circular Connector - SS2R-120-1804-000 (2-Pin Connector) (18 AWG) WA = 4.5-inch Cable w/Blade Terminals 6,3 mm x 0,8 mm (16 AWG)* XA = 10-inch Cable w/ Metripack 2-Pin Shroud Connector 153000027 (18 AWG) YA = 6-inch Cable w/Amp Super Seal 1.5 - 282104-1 (2-Pin Connector) (18 AWG)* ZA = 10-inch Cable w/Deutsch DT06-2S-CE06 (2-Socket Connector) (18 AWG) AB = Deutsch DT04-2P-E005 (2-Pin Connector) CB = 6-inch Cable w/ AMP Super Seal 1.5 - 282080-1 (2-Pin Connector) (18 AWG) DB = 10-inch Cable w/AMP 2,5 mm System Series Connector 1-967402-1 (18 AWG)* EB = 4.5-inch Cable w/Packard Shroud Connector 12015792 (2-Pin Connector) (18 AWG) FB = 10-inch Cable w/Metripack 150 Delphi 12052641 (2-Pin Connector) (18 AWG)

\*These connectors are designed for dual circuit (SPDT) by default. They can be used for single-circuit applications (SPNC/SPNO) by making suitable connections. Refer to wiring diagram.

# PRESSURE SWITCHES, HP, HE, MH, ME, LP, LE, 5000, 1000 SERIES

## DIMENSIONS - HIGH PRESSURE: HP SERIES (BASE STYLE A), HE SERIES

Base Style A key specifications • Life: 2 million (HP), 1 million (HE); Burst pressure: 20,000 psi

Figure 1. AMP Superseal 1.5

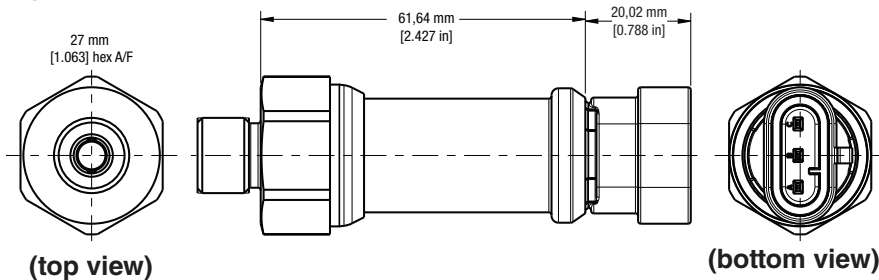

**Female Connector Part Number (included):** C-282105  
**Male Mating Connector (customer provided):** C-282087  
**IP Rating:** IP67

Figure 2. Deutsch

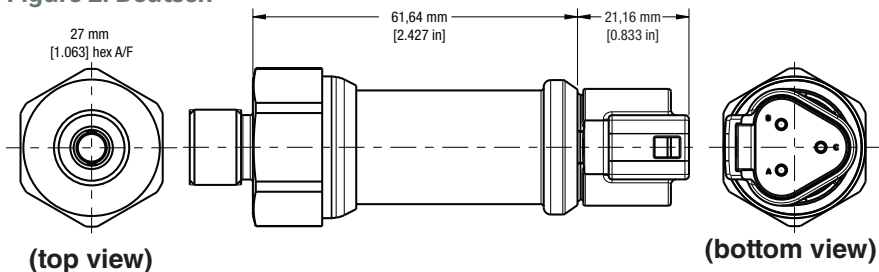

**Female Connector Part Number (included):** DT04-3P  
**Male Mating Connector (customer provided):** DT06-3S  
**IP Rating:** IP67

Figure 3. Spade Terminal

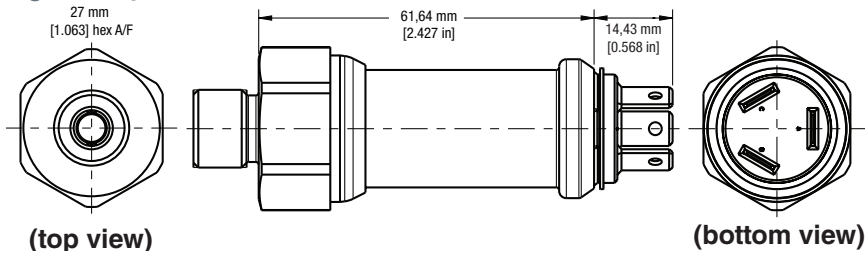

Figure 4. Screw Terminal

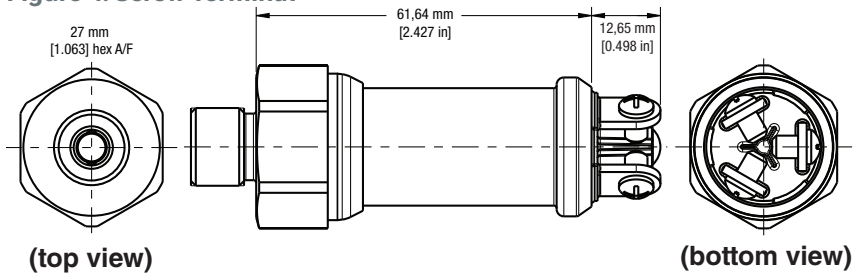
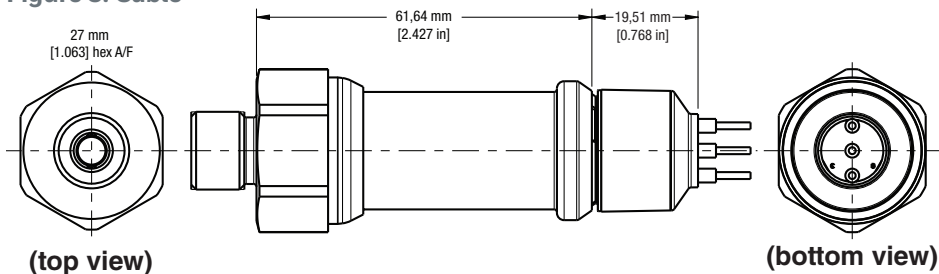

Figure 5. Cable



**IP Rating:** IP67

# PRESSURE SWITCHES, HP, HE, MH, ME, LP, LE, 5000, 1000 SERIES

## DIMENSIONS - HIGH PRESSURE: HP SERIES (BASE STYLE B)

Base Style B key specifications • Life: 1 million; Burst pressure: 9,000 psi

Figure 6. HP Series Base Style B

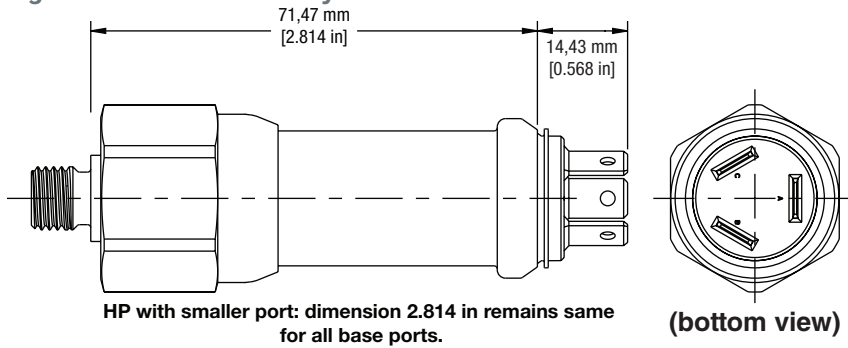

Figure 7. HP Series Pressure Port Dimensions

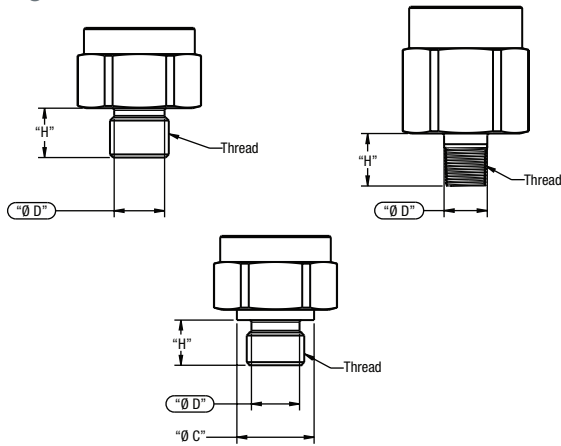

TABLE 3. HP/HE SERIES PRESSURE PORT DIAMETERS AND HEIGHTS

Nomenclature Code	Thread	Height "A"	Diameter "ØD"	Diameter "ØC"	Height "H"
M	7/16-20 UNF	–	9,25 mm [0.364 in]	–	11 mm [0.433 in]
C <sup>1</sup>	1/2-20 UNF	–	10,85 mm [0.427 in]	–	11 mm [0.433 in]
G <sup>2</sup>	9/16-18 UNF	–	12,24 mm [0.482 in]	–	12 mm [0.472 in]
H	3/4-16 UNF	–	16,74 mm [0.66 in]	–	14 mm [0.551 in]
N	7/8-14 UNF	–	19,6 mm [0.773 in]	–	16 mm [0.630 in]
T	M10 x 1.0	1,60 mm [0.063 in]	9,25 mm [0.364 in]	13,79 mm [0.543 in]	11 mm [0.433 in]
E	M12 x 1.5	2,48 mm [0.098 in]	10,85 mm [0.427 in]	16,79 mm [0.661 in]	11 mm [0.433 in]
F <sup>2</sup>	M14 x 1.5	2,48 mm [0.098 in]	12,24 mm [0.482 in]	18,8 mm [0.74 in]	12 mm [0.472 in]
K	M18 x 1.5	2,48 mm [0.098 in]	16,74 mm [0.66 in]	23,8 mm [0.937 in]	14 mm [0.551 in]
B	1/8-27 NPT	–	10,29 mm [0.405 in]	–	12,497 mm [0.492 in]
A	1/4-18 NPT	–	13,72 mm [0.540 in]	–	17,63 mm [0.694 in]

<sup>1</sup>Port Style C: Switches less than 975 psi will use Base Style B; switches greater than 975 psi will use Base Style A.

<sup>2</sup>Port Styles F and G: Switches less than 350 psi will use Base Style B; switches greater than 350 psi will use Base Style A. Switches less than 150 psi will use only Base Style B.

# PRESSURE SWITCHES, HP, HE, MH, ME, LP, LE, 5000, 1000 SERIES

## DIMENSIONS - MEDIUM PRESSURE: MH SERIES

Figure 8. AMP Superseal 1.5

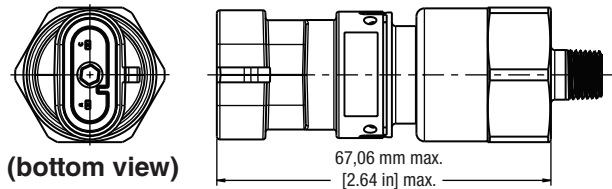

Figure 9. Deutsch 2-pin

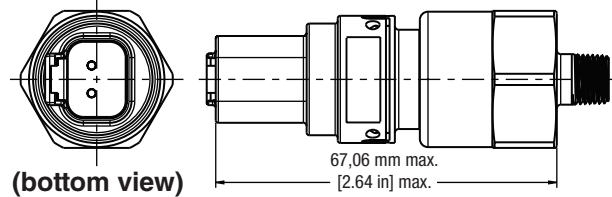

Figure 10. Wire out

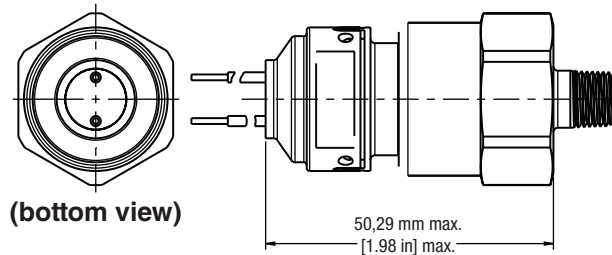

Figure 11. Blade terminal

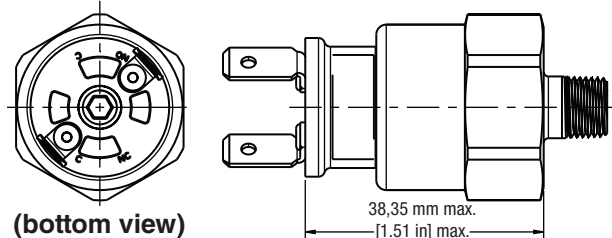

Figure 12. Screw terminal

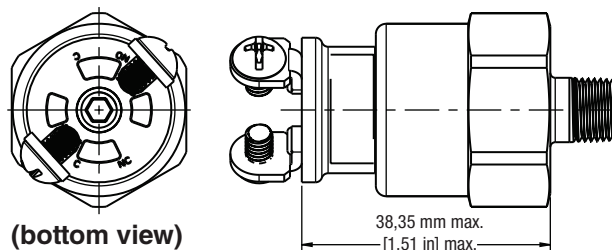

Figure 13. MH Series Pressure Port Dimensions

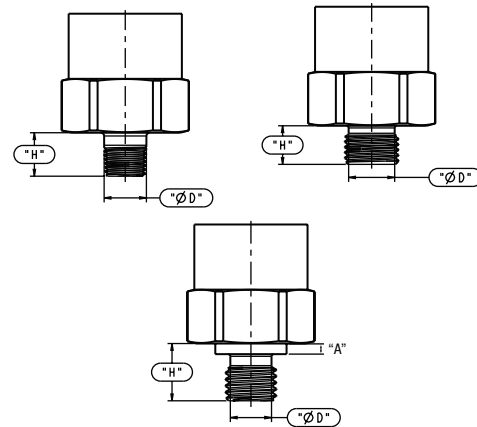

TABLE 4. MH SERIES PRESSURE PORT DIAMETERS AND HEIGHTS

Port	Diameter "ØD"	Height "H"
R 1/2 BSPT	21,34 mm [0.840 in]	17,09 mm [0.673 in]
R 1/4 BSPT	13,46 mm [0.530 in]	13,74 mm [0.541 in]
R 1/8 BSPT	9,96 mm [0.392 in]	10,24 mm [0.403 in]
1/8-27 PTF	10,34 mm [0.407 in]	9,24 mm [0.364 in]
1/4-18 NPT	13,72 mm [0.540 in]	17,63 mm [0.694 in]
1/8-27 NPT	10,29 mm [0.405 in]	12,497 mm [0.492 in]
G 1/4 BSPP	11,1 mm [0.437 in]	11,20 mm [0.441 in]
G 1/8 BSPP	8,28 mm [0.326 in]	7,59 mm [0.299 in]
3/4-16 UNF	16,74 mm [0.659 in]	11,1 mm [0.437 in]
7/16-20 UNF	9,25 mm [0.364 in]	9,09 mm [0.358 in]
9/16-18 UNF	12,24 mm [0.482 in]	10,00 mm [0.394 in]
1/2-20 UNF	10,85 mm [0.427 in]	9,09 mm [0.358 in]

Port	Height "A"	Diameter "ØC"	Diameter "ØD"	Height "H"
M14 × 1.5	2,49 mm [0.098 in]	18,8 mm [0.74 in]	11,71 mm [0.461 in]	10,998 mm [0.433 in]
M12 × 1.5	2,49 mm [0.098 in]	16,79 mm [0.661 in]	9,70 mm [0.382 in]	10,998 mm [0.433 in]
M10 × 1.0	1,6 mm [0.063 in]	13,79 mm [0.543 in]	8,41 mm [0.331 in]	8,51 mm [0.335 in]

# PRESSURE SWITCHES, HP, HE, MH, ME, LP, LE, 5000, 1000 SERIES

## DIMENSIONS - MEDIUM PRESSURE: ME SERIES

Figure 14. AMP Superseal 1.5



Figure 15. Deutsch 3-pin

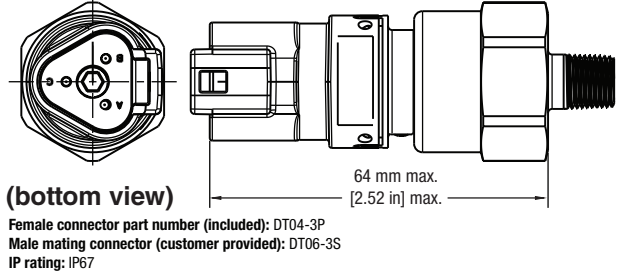

Figure 16. Deutsch 2-pin

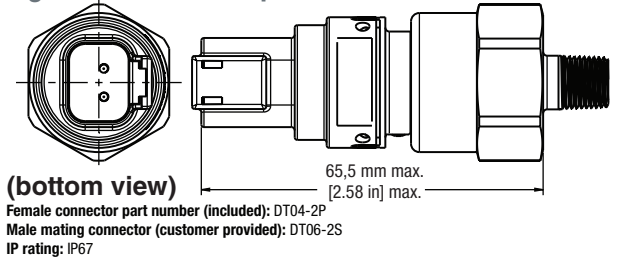

Figure 17. Wire out

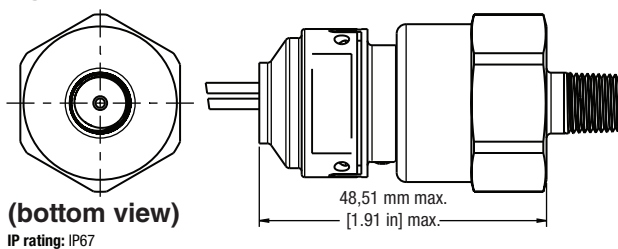

Figure 18. Blade terminal

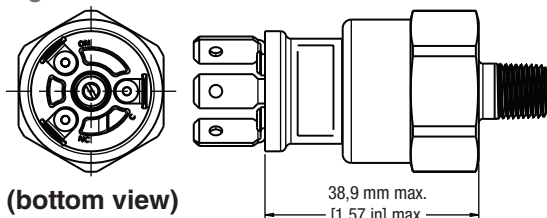

Figure 19. Screw terminal

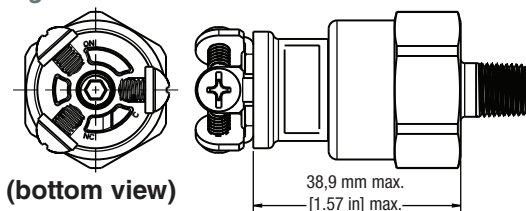

Figure 20. ME Series Pressure Port Dimensions

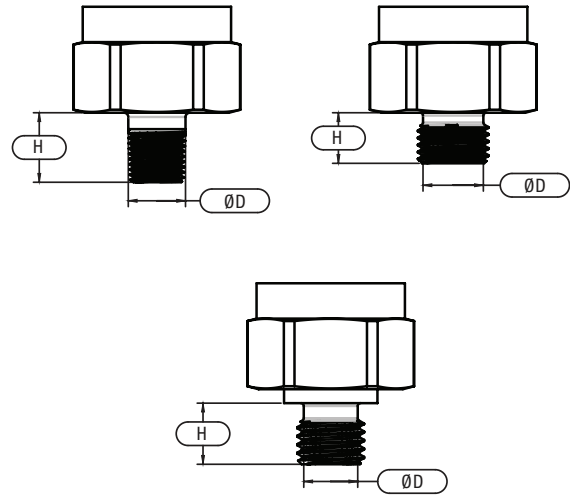

TABLE 5. ME SERIES PRESSURE PORT DIAMETERS AND HEIGHTS

Port	Diameter "ØD"	Height "H"
R 1/2 BSPT	21,34 mm [0.840 in]	17,09 mm [0.673 in]
R 1/4 BSPT	13,46 mm [0.530 in]	13,74 mm [0.541 in]
R 1/8 BSPT	9,96 mm [0.392 in]	10,24 mm [0.403 in]
1/8-27 PTF	10,34 mm [0.407 in]	9,24 mm [0.364 in]
1/4-18 NPT	13,72 mm [0.540 in]	17,63 mm [0.694 in]
1/8-27 NPT	10,29 mm [0.405 in]	12,497 mm [0.492 in]
G 1/4 BSPP	11,1 mm [0.437 in]	11,20 mm [0.441 in]
G 1/8 BSPP	8,28 mm [0.326 in]	7,59 mm [0.299 in]
3/4-16 UNF	16,74 mm [0.659 in]	11,1 mm [0.437 in]
7/16-20 UNF	9,25 mm [0.364 in]	9,09 mm [0.358 in]
9/16-18 UNF	12,24 mm [0.482 in]	10,00 mm [0.394 in]
1/2-20 UNF	10,85 mm [0.427 in]	9,09 mm [0.358 in]

Port	Height "A"	Diameter "ØC"	Diameter "ØD"	Height "H"
M14 × 1.5	2,49 mm [0.098 in]	18,8 mm [0.74 in]	11,71 mm [0.461 in]	10,998 mm [0.433 in]
M12 × 1.5	2,49 mm [0.098 in]	16,79 mm [0.661 in]	9,70 mm [0.382 in]	10,998 mm [0.433 in]
M10 × 1.0	1,6 mm [0.063 in]	13,79 mm [0.543 in]	8,41 mm [0.331 in]	8,51 mm [0.335 in]



# PRESSURE SWITCHES, HP, HE, MH, ME, LP, LE, 5000, 1000 SERIES

## DIMENSIONS - LOW PRESSURE: LP SERIES, LE SERIES

Figure 21. AMP Superseal 1.5

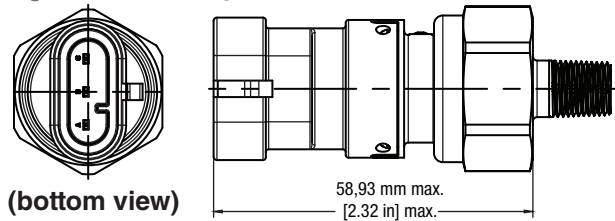

Figure 22. Deutsch 3-pin

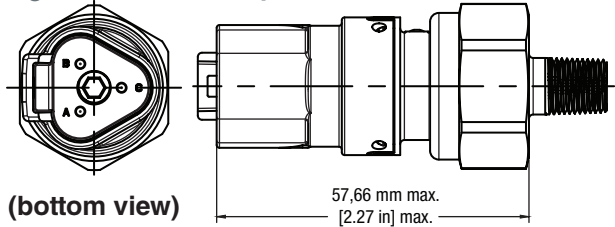

Figure 23. Deutsch 2-pin

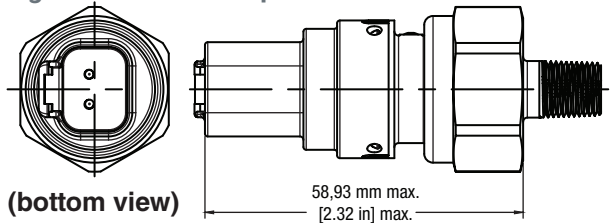

Figure 24. Wire out

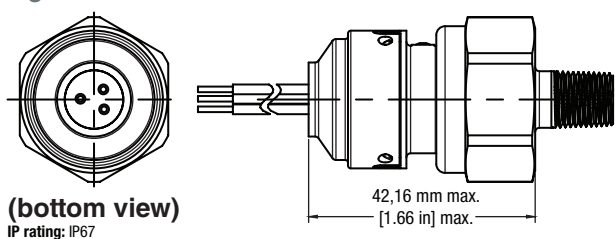

Figure 25. Spade terminal

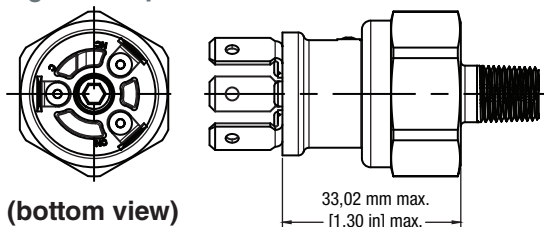

Figure 26. Screw terminal

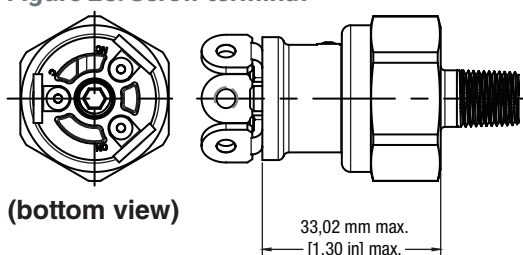

Figure 27. LP/LE Series Pressure Port Dimensions

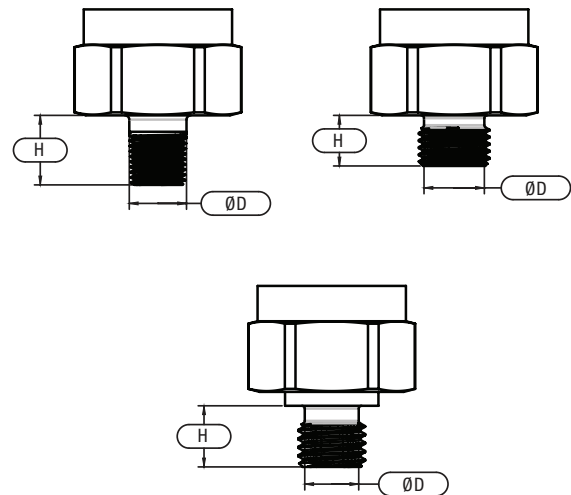

TABLE 6. LP/LE SERIES PRESSURE PORT DIAMETERS AND HEIGHTS

Port	Diameter "ØD"	Height "H"
R 1/2 BSPT	21,34 mm [0.840 in]	17,09 mm [0.673 in]
R 1/4 BSPT	13,46 mm [0.530 in]	13,74 mm [0.541 in]
R 1/8 BSPT	9,96 mm [0.392 in]	10,24 mm [0.403 in]
1/8-27 PTF	10,34 mm [0.407 in]	9,24 mm [0.364 in]
1/4-18 NPT	13,72 mm [0.540 in]	17,63 mm [0.694 in]
1/8-27 NPT	10,29 mm [0.405 in]	12,497 mm [0.492 in]
G 1/4 BSPP	11,1 mm [0.437 in]	11,20 mm [0.441 in]
G 1/8 BSPP	8,28 mm [0.326 in]	7,59 mm [0.299 in]
3/4-16 UNF	16,74 mm [0.659 in]	11,1 mm [0.437 in]
7/16-20 UNF	9,25 mm [0.364 in]	9,09 mm [0.358 in]
9/16-18 UNF	12,24 mm [0.482 in]	10,00 mm [0.394 in]
1/2-20 UNF	10,85 mm [0.427 in]	9,09 mm [0.358 in]

Port	Height "A"	Diameter "ØC"	Diameter "ØD"	Height "H"
M14 × 1.5	2,49 mm [0.098 in]	18,8 mm [0.74 in]	11,71 mm [0.461 in]	10,998 mm [0.433 in]
M12 × 1.5	2,49 mm [0.098 in]	16,79 mm [0.661 in]	9,70 mm [0.382 in]	10,998 mm [0.433 in]
M10 × 1.0	1,6 mm [0.063 in]	13,79 mm [0.543 in]	8,41 mm [0.331 in]	8,51 mm [0.335 in]

# PRESSURE SWITCHES, HP, HE, MH, ME, LP, LE, 5000, 1000 SERIES

## DIMENSIONS - 1000 SERIES, 5000 SERIES

Figure 28. 1000 Series Dimensions

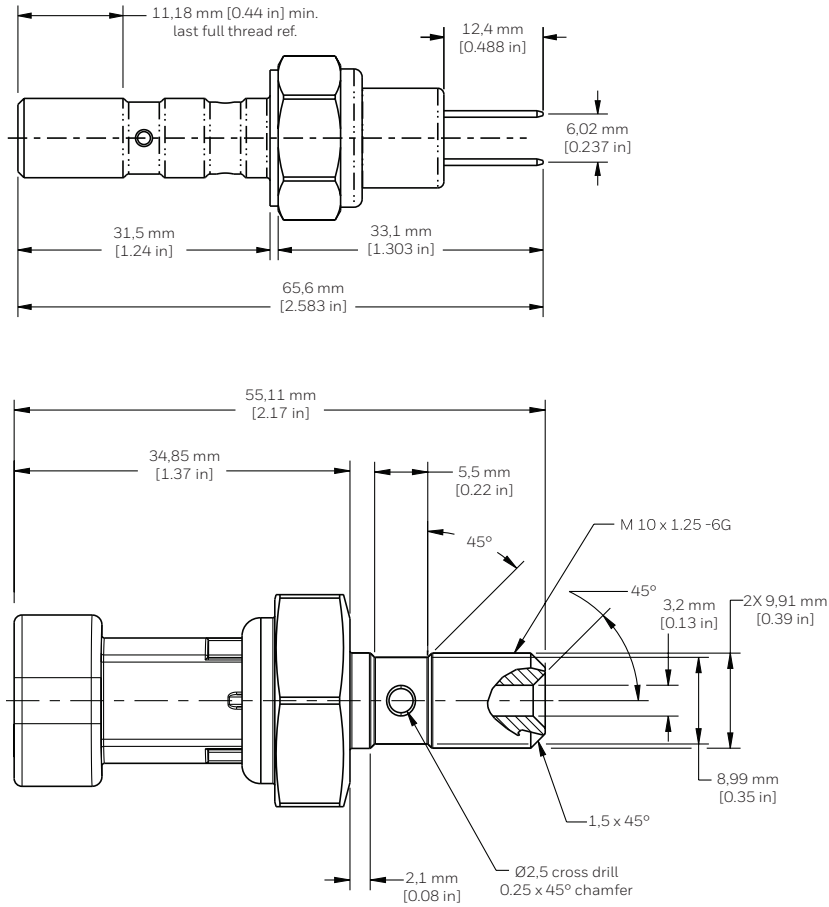
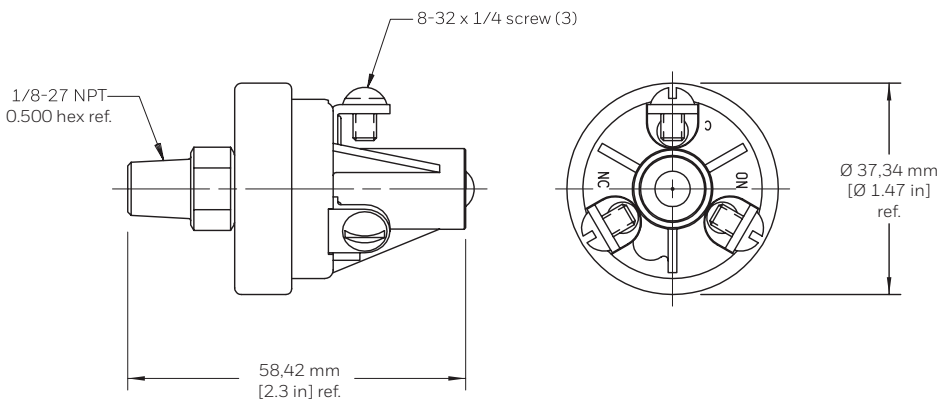

Figure 29. 5000 Series Dimensions



# PRESSURE SWITCHES, HP, HE, MH, ME, LP, LE, 5000, 1000 SERIES

## NOMENCLATURE: HIGH PRESSURE

For example, **HPR05500PFNSPAAA01** defines a high pressure switch, rising factory set, non-adjustable set point, 550 psi set point, psig, sealed gage pressure unit, M14 x 1.5 port type, SPST-NO silver contacts output, cold-rolled steel base, glycol-based fluid (EPDM) actuation/application, spade terminal connectors, standard switch, individually boxed units.

HP	R	05500	P	F	N	S	P	AA	A	01
Series	Set Point	Pressure Set Point	Pressure Unit	Port Type	Output	Base	Actuation/ Application	Connector Type	Options	Packaging Options
<b>HP Series</b> <b>HE Series</b> (100 psi to 4500 psi), High Pressure Switch	<b>R</b> Rising factory set, non-adjustable <b>F</b> Falling factory set, non-adjustable <b>NOTE:</b> Set point below 100 psi is available only with HP Series (Body Style B).	6.89 bar to 310.26 bar (100 psi to 4500 psi) <b>NOTE:</b> Pressure set point is always five digits. For bar, the set point value will be multiplied by 100 and entered in the listing. For example, 15,45 Bar is noted as 01545. This allows for 2 decimal places. For psi, the set point value will be multiplied by 10 and entered in the listing. For example, 245.5 psi is noted as 02455. This allows for 1 decimal place.	<b>P</b> psig, sealed gage <b>B</b> bar, sealed gage	<b>A</b> 1/4-18 NPT <b>B</b> 1/8-27 NPT <b>C</b> 1/2-20 UNF <b>E</b> M12 x 1.5 <b>F</b> M14 x 1.5 <b>G</b> 9/16-18 UNF <b>H</b> 3/4-16 UNF <b>K</b> M18 x 1.5 <b>M</b> 7/16-20 UNF <b>N</b> 7/8-14 UNF <b>T</b> M10 x 1.0	<b>N</b> SPST-NO, silver contacts <b>C</b> SPST-NC, silver contacts <b>D</b> SPDT-NO/NC, silver contacts <b>H</b> NO, gold inlay contacts <b>J</b> NC, gold inlay contacts <b>K</b> SPDT(NO/NC), gold inlay contacts <b>E</b> NO, with 510 Ω/ 0.5 W & 160 Ω/ 0.5 W resistors <b>F</b> NC, with 3000 Ω/ 0.125 W resistor	<b>S</b> Cold-rolled steel	<b>N</b> Petroleum-based hydraulic fluid (Nitrile) <b>P</b> Glycol-based fluid (EPDM) EPDM O-ring option only available from 100 psi to 250 psi.	<b>AA</b> 1/4 in Spade Terminals* <b>BA</b> Screw Terminals* <b>CA</b> Deutsch DT04-3P-ED05 (3-Pin Connector)* <b>DA</b> Amp Super Seal 1.5 - 282105-1 (3-Pin Connector)* <b>EA</b> 10-inch Cable, 18 AWG (Wire Out, No Connector) <b>FA</b> 10-inch Cable w/Deutsch DT04-3P-ED05 (3-Pin Connector) (16 AWG)* <b>GA</b> 10-inch Cable w/Amp Super Seal 1.5 - 282105-1 (3-Pin Connector) (18 AWG)* <b>HA</b> 10-inch Cable w/Metripack 250 Delphi 15300027 (2-Pin Connector) (18 AWG) <b>JA</b> 10-inch Cable w/ Din43650-C (3-Pin Connector) (18 AWG)* <b>KA</b> 10-inch Cable w/M12x1 (Brad Harrison Micro) - 21032121306 Harting P/N (3-Pin Connector) (18 AWG)* <b>LA</b> 10-inch Cable w/Packard Weatherpack Male Terminal-12020827 (3-Pin Connector) (18 AWG)* <b>MA</b> 10-inch Cable w/Deutsch DT04-2P-ED05 (2-Pin Connector) (18 AWG) <b>NA</b> 3-inch Cable w/Packard 2P Tower Connector - 12015792 (2-Pin Connector) (18 AWG) <b>PA</b> 2.75-inch Cable w/Packard 2P Shroud Connector - 12010973 (2-Pin Connector) (18 AWG) <b>RA</b> 4-inch Cable w/Packard 2P Shroud Connector - 12010973 (2-Pin Connector) (16 AWG) <b>SA</b> 5.5-inch Cable w/ITT Cannon 2P Sure-Seal Circular Connector - SS2R-120-1804-000 (2-Pin Connector) (18 AWG) <b>TA</b> 8.5-inch Cable w/ITT Cannon 3P Sure-Seal Circular Connector - SS3R-120-8551-001 (3-Pin Connector) (16 AWG)* <b>UA</b> 10-inch Cable - Vacuum Impregnated w/Deutsch DT06-3S-EPO6 (3-Socket Connector) (16 AWG)* <b>VA</b> 10-inch Cable - Vacuum Impregnated w/Deutsch DT04-3P-ED05 (3-Pin Connector) (16 AWG)* <b>WA</b> 4.5-inch Cable w/ 1/4 in Spade Terminals 6.3 mm x 0.8 mm (16 AWG) <b>XA</b> 10-inch Cable w/ Metripack 2-Pin Shroud Connector 15300027 (16 AWG) <b>YA</b> 6-inch Cable w/Amp Super Seal 1.5 - 282104-1 (2-Pin Connector) (18 AWG) <b>ZA</b> 10-inch Cable w/Deutsch DT06-2S-CE06 (2-Socket Connector) (18 AWG) <b>BB</b> 10-inch Cable w/Metripack 150 Delphi 12129615 (3-Pin Connector) (18 AWG) <b>CB</b> 6-inch Cable w/AMP Super Seal 1.5 - 282080-1 (2-Pin Connector) (18 AWG) <b>DB</b> 10-inch Cable w/AMP 2.5 mm System Series Connector 1-967402-1 (18 AWG)* <b>EB</b> 4.5-inch Cable w/Packard Shroud Connector 12015792 (2-Pin Connector) (18 AWG) <b>FB</b> 10-inch Cable w/Metripack 150 Delphi 12052841 (2-Pin Connector) (18 AWG) <b>GB</b> 8.5-inch Cable w/Deutsch Plug HD 18-3-36S (3-Pin Connector) (16 AWG)*	<b>A</b> Standard switch <b>B</b> With 3 shrink sleeve <b>C</b> With shrink sleeve (plastic coating) <b>D</b> With shrink sleeve (acrylic coating) <b>F</b> 304.8 mm (12 in) total wire length <b>G</b> With conduit sleeve <b>H</b> With Vibra seal for port threads <b>J</b> #8-32 screw with external tooth lockwasher*** <b>K</b> 914.4 mm (36 in) total wire length <b>L</b> 304.8 mm (12 in) total wire length with acrylic sleeve <b>M</b> 914.4 mm (36 in) total wire length with acrylic sleeve *** For screw terminal option only	<b>01</b> Individually boxed units* <b>02</b> Individually boxed units** <b>15</b> 25 individual boxes packed in bulk packaging* <b>16</b> 25 individual boxes packed in bulk packaging** <b>20</b> 50 individual boxes packed in bulk packaging* <b>21</b> 50 individual boxes packed in bulk packaging** <b>25</b> 25 units in bulk packaging* <b>26</b> 25 units in bulk packaging** <b>50</b> 50 individual parts in bulk packaging*

### HP Series Port Types

Thread Type	Base Style A	Base Style B
A = 1/4-18 NPT	n/a	100 psi to 4500 psi
B = 1/8-27 NPT	n/a	100 psi to 4500 psi
C = 1/2-20 UNF	>975 psi	n/a
E = M12 x 1.5	n/a	100 psi to 4500 psi
F = M14 x 1.5	>350 psi	n/a
G = 9/16-18 UNF	>350 psi	<350 psi
H = 3/4-16 UNF	>150 psi	<150 psi
K = M18 x 1.5	150 psi to 4500 psi	n/a
M = 7/16-20 UNF	n/a	100 psi to 4500 psi
N = 7/8-14 UNF	150 psi to 4500 psi	n/a
T = M10 x 1.0	n/a	100 psi to 4500 psi

Port Type A, B, E, M, and T will be available only with HP Series. Base Style B will be available only with HP Series

\*These connectors are designed for dual circuit (SPDT) by default. They can be used for single-circuit applications (SPNC/SPNO) by making suitable connections. Refer to wiring diagram.

# PRESSURE SWITCHES, HP, HE, MH, ME, LP, LE, 5000, 1000 SERIES

## NOMENCLATURE: MEDIUM PRESSURE, HIGH BURST

For example, **MHR01500PPFNMAAA01** defines a medium pressure, high burst switch, rising factory set, non-adjustable set point, 150 psi set point, psig, sealed gage pressure unit, 1/4-18 NPT port type, SPST-NO contacts output, plated steel base, LTNB diaphragm, and spade terminal connectors.

MH	R	01500	P	A	P	N	M	AA	A	01
Series	Set Point	Pressure Set Point	Pressure Unit	Port Type	Output	Base	Actuation/ Application	Connector Type	Options	Packaging Options
<b>MH Series Medium Pressure Switch</b>	<b>R</b> Rising factory set, non-adjustable	0.24 bar to 10.34 bar [3.5 psi to 150 psi]	<b>P</b> psig, sealed gage	<b>A</b> 1/4-18 NPT	<b>P</b> SPST-NO	<b>N</b> Cold-rolled steel	<b>M</b> LTNB diaphragm (Low-temp Buna N)	<b>AA</b> 1/4 in Spade Terminals	<b>A</b> Standard switch	<b>01</b> Individually boxed units
	<b>F</b> Falling factory set, non-adjustable	<b>NOTE: Pressure set point is always five digits.</b>	<b>B</b> bar, sealed gage	<b>B</b> 1/8-27 NPT	<b>M</b> SPST-NC		<b>N</b> HNBR diaphragm (Hydrogenated Nitrile Butadiene Rubber)	<b>BA</b> Screw Terminals	<b>C</b> With shrink sleeve (plastic coating)	<b>15</b> 25 individual boxes packed in bulk packaging
	<b>T</b> Rising, field adjustable*	For bar, the set point value will be multiplied by 100 and entered in the listing. For example, 15.45 Bar is noted as 01545. This allows for 2 decimal places.	<b>M</b> bar, true gage*	<b>C</b> 1/2-20 UNF			<b>E</b> EPDM diaphragm (Ethylene-Propylene-Diene Monomer)	<b>DA</b> Amp Super Seal 1.5 - 282105-1 (3-Pin Connector)	<b>D</b> With shrink sleeve (acrylic coating)	<b>20</b> 150 units in bulk packaging
	<b>C</b> Falling, field adjustable*	For psi, the set point value will be multiplied by 10 and entered in the listing. For example, 245.5 psi is noted as 02455. This allows for 1 decimal place.	<b>T</b> psig, true gage*	<b>D</b> 1/8-27 PTF				<b>EA</b> 10-inch Cable, 18 AWG (Wire Out, No Connector)	<b>F</b> 304.8 mm [12 in] total wire length	<b>25</b> 25 units in bulk packaging
	* Field adjustable option is only available for: 1. Blade and screw terminations (SPDT, SPNO, SPNC) 2. Deutsch DT04-2P (SPDT, SPNO, SPNC) 3. Amp Superseal 1.5 (3-pin) (SPNO & SPNC)		<b>G</b> psig, sealed gage with epoxy**	<b>E</b> M12 x 1.5				<b>HA</b> 10-inch Cable w/Metripack 280 Delphi 15300002 (2-Pin Connector) (18 AWG)*	<b>G</b> With conduit sleeve	<b>30</b> 150 individual boxes packed in bulk packaging
			<b>H</b> bar, sealed gage with epoxy**	<b>F</b> M14 x 1.5				<b>MA</b> 10-inch Cable w/Deutsch DT04-2P-E005 (2-Pin Connector) (18 AWG)	<b>H</b> With Vibra seal for threads	
			**Blade and screw electrical terminations are available with only the true gage option.	<b>G</b> 9/16-18 UNF				<b>NA</b> 3-inch Cable w/Packard 2P Tower Connector - 12015792 (2-Pin Connector) (18 AWG)	<b>J</b> #8-32 screw with external tooth lockwasher***	
			**Connector cavity and roll forming area filled with epoxy to meet dunk test sealing capability.	<b>H</b> 3/4-16 UNF				<b>PA</b> 2.75-inch Cable w/Packard 2P Shroud Connector - 12010973 (2-Pin Connector) (18 AWG)	<b>K</b> 914.4 mm [36 in] total wire length	
				<b>J</b> G1/8 BSPP				<b>RA</b> 4-inch Cable w/Packard 2P Shroud Connector - 12010973 (2-Pin Connector) (16 AWG)	<b>L</b> 304.8 mm [12 in] total wire length w/ shrink sleeve	
				<b>L</b> 3/8-24 UNF				<b>SA</b> 5.5-inch Cable w/ITT Cannon 2P Sure-Seal Circular Connector - SSCR-120-1804-000 (2-Pin Connector) (18 AWG)	<b>M</b> 914.4 mm [36 in] total wire length w/ shrink sleeve	
				<b>M</b> 7/16-20 UNF				<b>WA</b> 4.5-inch Cable w/ 1/4 in Spade Terminals 6.3 mm x 0.8 mm (16 AWG)*	***applicable only for screw terminal version.	
				<b>P</b> 1/2-14 NPT				<b>XA</b> 10-inch Cable w/ Metripack 2-Pin Shroud Connector 153000287 (18 AWG)		
				<b>R</b> R1/8 BSPT				<b>YA</b> 6-inch Cable w/Amp Super Seal 1.5 - 282104-1 (2-Pin Connector) (18 AWG)*		
				<b>T</b> M10 x 1.0				<b>ZA</b> 10-inch Cable w/Deutsch DT06-2S-CE06 (2-Socket Connector) (18 AWG)		
				<b>V</b> R1/2 BSPT				<b>AB</b> Deutsch DT04-2P-E005 (2-Pin Connector)		
				<b>Y</b> G1/4 BSPP				<b>CB</b> 6-inch Cable with Amp Super Seal 1.5 - 282080-1 (2-Pin Connector) (18 AWG)		
				<b>Z</b> R1/4 BSPT				<b>DB</b> 10-inch Cable w/AMP 2.5 mm System Series Connector 1-967402-1 (18 AWG)*		
								<b>EB</b> 4.5-inch Cable w/Packard Shroud Connector 12015792 (2-Pin Connector) (18 AWG)		
								<b>FB</b> 10-inch Cable w/Metripack 150 Delphi 12052841 (2-Pin Connector) (18 AWG)		

\*These connectors are designed for dual circuit (SPDT) by default. They can be used for single-circuit applications (SPNO/SPNC) by making suitable connections. Refer to wiring diagram.

# PRESSURE SWITCHES, HP, HE, MH, ME, LP, LE, 5000, 1000 SERIES

## NOMENCLATURE: MEDIUM PRESSURE

For example, **MER01500FPVKAA01** defines a medium pressure switch, rising factory set, non-adjustable set point, 55 psi set point, psig, sealed gage pressure unit, M14 x 1.5 port type, SPST-NO gold-plated contacts output, stainless steel base, Kapton® diaphragm (Teflon® coated), Nitrile O-ring actuation/application, spade terminal connectors, standard switch, individually boxed units.

ME Series	R	01500	P	F	P	V	K	AA	A	01																			
Medium Pressure Switch	Set Point	Pressure Set Point	Pressure Unit	Port Type	Output	Base	Actuation/ Application	Connector Type	Options	Packaging Options																			
<b>R</b> Rising factory set, non-adjustable	<b>F</b> Falling factory set, non-adjustable	<b>T</b> Rising, field adjustable*	<b>C</b> Falling, field adjustable*	<b>P</b> psig, sealed gage	<b>B</b> bar, sealed gage	<b>M</b> bar, true gage	<b>T</b> psig, true gage	<b>G</b> psig, sealed gage with epoxy	<b>H</b> bar, sealed gage with epoxy	<b>G</b> 9/16-18 UNF	<b>H</b> 3/4-16 UNF	<b>J</b> G1/8 BSPP	<b>M</b> 7/16-20 UNF	<b>R</b> R1/8 BSPT	<b>T</b> M10 x 1.0	<b>V</b> R1/2 BSPT	<b>Y</b> G1/4 BSPP	<b>Z</b> R1/4 BSPT											
<b>1,72 bar to 24,13 bar [25 psi to 350 psi]</b>	<b>NOTE: Pressure set point is always five digits.</b>	<b>For bar, the set point value will be multiplied by 100 and entered in the listing. For example, 15,45 Bar is noted as 01545. This allows for 2 decimal places.</b>	<b>For psi, the set point value will be multiplied by 10 and entered in the listing. For example, 245.5 psi is noted as 02455. This allows for 1 decimal place.</b>	<b>Blade and screw electrical terminations are available with only the true gage option.</b>																									
<b>SPST-NO, gold-plated contacts</b>	<b>SPST-NC, gold-plated contacts</b>	<b>SPDT-NO/NC, gold-plated contacts</b>	<b>NO, with 510 Ω/ 0.5 W &amp; 160 Ω/ 0.5 W resistors</b>	<b>NC, with 3000 Ω/ 0.125 W resistor</b>																									
<b>Cold-rolled steel with zinc plating</b>	<b>Stainless steel</b>																												
<b>Kapton® diaphragm (Teflon® coated), Nitrile O-ring*</b>	<b>Kapton® diaphragm (Teflon® coated), EPDM O-ring*</b>																												
<b>1/4 in Spade Terminals</b>	<b>Screw Terminals</b>	<b>Deutsch DT04-3P-E005 (3-Pin Connector)</b>	<b>Amp Super Seal 1.5 - 282105-1 (3-Pin Connector)</b>	<b>10-inch Cable, 18 AWG (Wire Out, No Connector)</b>	<b>10-inch Cable w/Deutsch DT04-3P-E005 (3-Pin Connector) (16 AWG)*</b>	<b>10-inch Cable w/Amp Super Seal 1.5 - 282105-1 (3-Pin Connector) (18 AWG)*</b>	<b>10-inch Cable w/Metripack 280 Delphi 15300002 (2-Pin Connector) (18 AWG)*</b>	<b>10-inch Cable w/Din43650-C (3-Pin Connector) (18 AWG)*</b>	<b>10-inch Cable w/M12x1 (Brad Harrison Micro) - 21032121306 Harting P/N (3-Pin Connector) (18 AWG)*</b>	<b>10-inch Cable w/Packard Weatherpack Male Terminal - 12020227 (3-Pin Connector) (18 AWG)*</b>	<b>10-inch Cable w/Deutsch DT04-2P-E005 (2-Pin Connector) (18 AWG)</b>	<b>3-inch Cable w/Packard 2P Tower Connector - 12015792 (2-Pin Connector) (18 AWG)</b>	<b>2.75-inch Cable w/Packard 2P Shroud Connector - 12010973 (2-Pin Connector) (18 AWG)</b>	<b>4-inch Cable w/Packard 2P Shroud Connector - 12010973 (2-Pin Connector) (16 AWG)</b>	<b>5.5-inch Cable w/ITT Cannon 2P Sure-Seal Circular Connector - SSR-120-1804-000 (2-Pin Connector) (18 AWG)</b>	<b>8.5-inch Cable w/ITT Cannon 3P Sure-Seal Circular Connector - SSR-120-8551-001 (3-Pin Connector) (16 AWG)*</b>	<b>10-inch Cable - Vacuum Impregnated w/Deutsch DT06-3S-EPO6 (3-Socket Connector) (16 AWG)*</b>	<b>10-inch Cable - Vacuum Impregnated w/Deutsch DT04-3P-E005 (3-Pin Connector) (16 AWG)*</b>	<b>4.5-inch Cable w/ 1/4 in Spade Terminals 6,3 mm x 0,8 mm (16 AWG)*</b>	<b>10-inch Cable w/ Metripack 2-Pin Shroud Connector 153000287 (18 AWG)</b>	<b>6-inch Cable w/Amp Super Seal 1.5 - 282104-1 (2-Pin Connector) (18 AWG)*</b>	<b>10-inch Cable w/Deutsch DT06-2S-CE06 (2-Socket Connector) (18 AWG)</b>	<b>Deutsch DT04-2P-E005 (2-Pin Connector)</b>	<b>10-inch Cable w/Metripack 150 Delphi 12129615 (3-Pin Connector) (18 AWG)*</b>	<b>6-inch Cable with Amp Super Seal 1.5 - 282180-1 (2-Pin Connector) (18 AWG)</b>	<b>10-inch Cable w/AMP 2.5 mm System Series Connector 1-967402-1 (18 AWG)*</b>	<b>4.5-inch Cable w/Packard Shroud Connector 12015792 (2-Pin Connector) (18 AWG)</b>	<b>10-inch Cable w/Metripack 150 Delphi 12052641 (2-Pin Connector) (18 AWG)</b>	<b>8.5-inch Cable w/Deutsch Plug HD 16-3 96S (3-Pin Connector) (16 AWG)</b>
<b>Standard switch</b>	<b>With 3 shrink sleeve</b>	<b>With shrink sleeve (plastic coating)</b>	<b>With shrink sleeve (acrylic coating)</b>	<b>With 1/8 W resistor between terminals</b>	<b>304.8 mm [12 in] total wire length</b>	<b>With conduit sleeve</b>	<b>With Vibra seal for port threads</b>	<b>#8-32 screw with external tooth lockwasher</b>	<b>914.4 mm [36 in] total wire length</b>	<b>With port neck O-ring for LPS</b>																			
<b>01</b> Individually boxed units	<b>15</b> 25 individual boxes packed in bulk packaging	<b>20</b> 150 units in bulk packaging	<b>25</b> 25 units in bulk packaging	<b>30</b> 150 individual boxes packed in bulk packaging																									

\*These connectors are designed for dual circuit (SPDT) by default. They can be used for single-circuit applications (SPNC/SPNO) by making suitable connections. Refer to wiring diagram.

# PRESSURE SWITCHES, HP, HE, MH, ME, LP, LE, 5000, 1000 SERIES

## NOMENCLATURE: LOW PRESSURE

For example, **LPR00550PPFVKA01** defines a low pressure switch, rising factory set, non-adjustable set point, 55 psi set point, psig, sealed gage pressure unit, M14 x 1.5 port type, SPST-NO gold-plated contacts output, stainless steel base, Kapton® diaphragm (Teflon® coated), Nitrile O-ring actuation/application, spade terminal connectors, standard switch, individually boxed units.

LP Series, LE Series Low Pressure Switch	R Set Point	00550 Pressure Set Point	P Pressure Unit	F Port Type	P Output	V Base	K Actuation/ Application	AA Connector Type	A Options	01 Packaging Options	
<b>R</b> Rising factory set, non-adjustable	<b>F</b> Falling factory set, non-adjustable	<b>T</b> Rising, field adjustable*	<b>C</b> Falling, field adjustable*	<b>P</b> psig, sealed gage	<b>A</b> 1/4-18 NPT	<b>M</b> SPST-NO, gold-plated contacts	<b>B</b> Brass	<b>K</b> Kapton® diaphragm (Teflon® coated), Nitrile O-ring <sup>1</sup>	<b>AA</b> 1/4 in Spade Terminals	<b>A</b> Standard switch	<b>01</b> Individually boxed units
<b>F</b> Falling factory set, non-adjustable	<b>T</b> Rising, field adjustable*	<b>C</b> Falling, field adjustable*	<b>P</b> bar, sealed gage	<b>B</b> 1/8-27 NPT	<b>M</b> SPST-NC, gold-plated contacts	<b>N</b> Cold-rolled steel with zinc plating	<b>H</b> Kapton® diaphragm (Teflon® coated), EPDM O-ring <sup>2</sup>	<b>BA</b> Screw Terminals	<b>B</b> With 3 shrink sleeve	<b>15</b> 25 individual boxes packed in bulk packaging	
<b>T</b> Rising, field adjustable*	<b>C</b> Falling, field adjustable*	<b>P</b> bar, true gage	<b>M</b> bar, true gage	<b>C</b> 1/2-20 UNF	<b>Y</b> SPDT-NO/NC, gold-plated contacts	<b>V</b> Stainless steel	<b>T</b> Tetzel® and Kapton® diaphragm, EPDM O-ring <sup>3</sup>	<b>CA</b> Deutsch DT04-3P-E005 (3-Pin Connector)	<b>C</b> With shrink sleeve (plastic coating)	<b>20</b> 150 units in bulk packaging	
<b>C</b> Falling, field adjustable*	<b>P</b> psig, true gage	<b>D</b> 1/8-27 PTF	<b>T</b> psig, true gage	<b>D</b> 1/8-27 PTF	<b>E</b> NO, with 510 Ω/1 W and 160 Ω/1 W resistors****	<b>E</b> NO, with 510 Ω/1 W and 160 Ω/1 W resistors****	<b>U</b> Tetzel® and Kapton® diaphragm, EPDM O-ring <sup>3</sup>	<b>DA</b> Amp Super Seal 1.5 - 282105-1 (3-Pin Connector)**	<b>D</b> With shrink sleeve (acrylic coating)	<b>25</b> 25 units in bulk packaging	
<b>C</b> Falling, field adjustable*	<b>G</b> psig, sealed gage with epoxy	<b>E</b> M12 x 1.5	<b>G</b> psig, sealed gage with epoxy	<b>E</b> M12 x 1.5	<b>F</b> NC, with 3000 Ω/0.125 W resistor	<b>F</b> NC, with 3000 Ω/0.125 W resistor	<b>Air</b> , Petroleum-based hydraulic fluid, engine oil <sup>2</sup> Glycol-based fluid <sup>3</sup> For high temperature fluid media ( <b>LE Series only</b> ) <sup>4</sup> For high temperature fluid media, glycol-based fluid ( <b>LE Series only</b> )	<b>EA</b> 10-inch Cable, 18 AWG (Wire Out, No Connector*)	<b>F</b> 304.8 mm [12 in] total wire length	<b>30</b> 150 individual boxes packed in bulk packaging	
<b>C</b> Falling, field adjustable*	<b>H</b> bar, sealed gage with epoxy	<b>F</b> M14 x 1.5	<b>H</b> bar, sealed gage with epoxy	<b>F</b> M14 x 1.5	<b>G</b> NC with 510 Ω/0.5 W and 160 Ω/0.5 W resistors****	<b>G</b> NC with 510 Ω/0.5 W and 160 Ω/0.5 W resistors****		<b>FA</b> 10-inch Cable w/Deutsch DT04-3P-E005 (3-Pin Connector) (16 AWG)*	<b>G</b> With conduit sleeve		
<b>C</b> Falling, field adjustable*	<b>J</b> bar, sealed gage with epoxy	<b>G</b> 9/16-18 UNF	<b>J</b> bar, sealed gage with epoxy	<b>G</b> 9/16-18 UNF	**** Available only on LP Series			<b>GA</b> 10-inch Cable w/Amp Super Seal 1.5 - 282105-1 (3-Pin Connector) (18 AWG)*	<b>H</b> With Vibra seal for port threads		
<b>C</b> Falling, field adjustable*	<b>M</b> bar, sealed gage with epoxy	<b>H</b> 3/4-16 UNF	<b>M</b> bar, sealed gage with epoxy	<b>H</b> 3/4-16 UNF				<b>HA</b> 10-inch Cable w/Metripack 280 Delphi 15300002 (2-Pin Connector) (18 AWG)*	<b>K</b> 914.4 mm [36 in] total wire length		
<b>C</b> Falling, field adjustable*	<b>N</b> bar, sealed gage with epoxy	<b>J</b> G1/8 BSPP	<b>N</b> bar, sealed gage with epoxy	<b>J</b> G1/8 BSPP				<b>JA</b> 10-inch Cable w/Din49650-C (3-Pin Connector) (18 AWG)*	<b>L</b> 304.8 mm [12 in] total wire length with acrylic sleeve		
<b>C</b> Falling, field adjustable*	<b>R</b> bar, sealed gage with epoxy	<b>M</b> 7/16-20 UNF	<b>R</b> bar, sealed gage with epoxy	<b>M</b> 7/16-20 UNF				<b>KA</b> 10-inch Cable w/M12x1 (Brad Harrison Micro) - 21032121306 Harting P/N (3-Pin Connector) (18 AWG)*	<b>M</b> 914.4 mm [36 in] total wire length with acrylic sleeve		
<b>C</b> Falling, field adjustable*	<b>T</b> psig, true gage	<b>R</b> R1/8 BSPT	<b>T</b> psig, true gage	<b>R</b> R1/8 BSPT				<b>LA</b> 10-inch Cable w/Packard Weatherpack Male Terminal - 12020827 (3-Pin Connector) (18 AWG)*	*** For screw terminal option only		
<b>C</b> Falling, field adjustable*	<b>V</b> bar, sealed gage with epoxy	<b>T</b> M10 x 1.0	<b>V</b> bar, sealed gage with epoxy	<b>T</b> M10 x 1.0				<b>MA</b> 10-inch Cable w/Deutsch DT04-2P-E005 (2-Pin Connector) (18 AWG)			
<b>C</b> Falling, field adjustable*	<b>Y</b> bar, sealed gage with epoxy	<b>V</b> R1/2 BSPT	<b>Y</b> bar, sealed gage with epoxy	<b>V</b> R1/2 BSPT				<b>NA</b> 3-inch Cable w/Packard 2P Tower Connector - 12015792 (2-Pin Connector) (18 AWG)			
<b>C</b> Falling, field adjustable*	<b>Z</b> bar, sealed gage with epoxy	<b>Y</b> G1/4 BSPP	<b>Z</b> bar, sealed gage with epoxy	<b>Y</b> G1/4 BSPP				<b>PA</b> 2.75-inch Cable w/Packard 2P Shroud Connector - 12010973 (2-Pin Connector) (18 AWG)			
<b>C</b> Falling, field adjustable*		<b>Z</b> R1/4 BSPT		<b>Z</b> R1/4 BSPT				<b>RA</b> 4-inch Cable w/Packard 2P Shroud Connector - 12010973 (2-Pin Connector) (16 AWG)			
<b>C</b> Falling, field adjustable*								<b>SA</b> 5.5-inch Cable w/ITT Cannon 2P Sure-Seal Circular Connector - SS2R-120-1804-000 (2-Pin Connector) (18 AWG)			
<b>C</b> Falling, field adjustable*								<b>TA</b> 8.5-inch Cable w/ITT Cannon 3P Sure-Seal Circular Connector - SS3R-120-8551-001 (3-Pin Connector) (16 AWG)			
<b>C</b> Falling, field adjustable*								<b>UA</b> 10-inch Cable - Vacuum Impregnated w/Deutsch DT06-3S-EPO6 (3-socket Connector) (16 AWG)*			
<b>C</b> Falling, field adjustable*								<b>VA</b> 10-inch Cable - Vacuum Impregnated w/Deutsch DT04-3P-E005 (3-Pin Connector) (16 AWG)*			
<b>C</b> Falling, field adjustable*								<b>WA</b> 4.5-inch Cable w/ 1/4 in Spade Terminals 6.3 mm x 0.8 mm (16 AWG)*			
<b>C</b> Falling, field adjustable*								<b>XA</b> 10-inch Cable w/ Metripack 2-Pin Shroud Connector 1530000287 (16 AWG)			
<b>C</b> Falling, field adjustable*								<b>YA</b> 6-inch Cable w/Amp Super Seal 1.5 - 282104-1 (2-Pin Connector) (18 AWG)*			
<b>C</b> Falling, field adjustable*								<b>ZA</b> 10-inch Cable w/Deutsch DT06-2S-CE06 (2-Socket Connector) (18 AWG)			
<b>C</b> Falling, field adjustable*								<b>AB</b> Deutsch DT04-2P-E005 (2-Pin Connector)			
<b>C</b> Falling, field adjustable*								<b>BB</b> 10-inch Cable w/Metripack 150 Delphi 12129615 (3-Pin Connector) (16 AWG)*			
<b>C</b> Falling, field adjustable*								<b>CB</b> 6-inch Cable with Amp Super Seal 1.5 - 282080-1 (2-Pin Connector) (18 AWG)			
<b>C</b> Falling, field adjustable*								<b>DB</b> 10-inch Cable w/AMP 2.5 mm System Series Connector 1-967402-1 (18 AWG)*			
<b>C</b> Falling, field adjustable*								<b>EB</b> 4.5-inch Cable w/Packard Shroud Connector 12015792 (2-Pin Connector) (18 AWG)			
<b>C</b> Falling, field adjustable*								<b>FB</b> 10-inch Cable w/Metripack 150 Delphi 12032641 (2-Pin Connector) (18 AWG)			
<b>C</b> Falling, field adjustable*								<b>GB</b> 8.5-inch Cable w/Deutsch Plug HD 16-3 96S (3-Pin Connector) (16 AWG)			

\*These connectors are designed for dual circuit (SPDT) by default. They can be used for single-circuit applications (SPNC/SPNO) by making suitable connections. Refer to wiring diagram.  
\*\*For electrical termination with SPST option, only SPNO configuration is available. SPNC configuration cannot be provided.