

Heavy Duty Fuse Clip, 10.3x38 mm, 1000 VDC/ 600 VAC - 15 A (UL)

new



M3 screw tin-plated



THT tin-plated



M3 screw nickel-plated



THT nickel-plated

1000 VDC/ 600 VAC · 15A (UL)

See below:
[Approvals and Compliances](#)

Description

- Solder, screw or rivet mounting
- Suitable gPV fuse link ASO 10.3x38
- Suitable E-Mobility fuse link AEO 10.3x38

Unique Selling Proposition

- Designed for high rated voltages
- Excellent price-performance ratio
- Low mounting height

Applications

- Photovoltaic applications
- Industrial Equipment
- Entertainment Equipment
- Direct current (DC) High voltage applications
- Chargers
- Power distribution

References

Fuseholder to [ASO 10.3x38](#)

Weblinks

[pdf data sheet](#), [html datasheet](#), [General Product Information](#), [Distributor-Stock-Check](#), [Detailed request for product](#), [Microsite](#)

Technical Data

| | | | |
|------------------------------|--------------------------------------|------------------------------|--|
| Fuse-Link | 10.3 x 38 / 10.3 x 85 mm | Soldering Methods | Wave Soldering Profile |
| Mounting | PCB | Solderability | 245 °C / 3 sec acc. to IEC 60068-2-20, Test Ta, method 1 |
| Terminal | Solder THT / screw / rivet | Resistance to Soldering Heat | 260 °C / 10 sec acc. to IEC 60068-2-20, Test Tb, method 1A |
| Rated Voltage | 1000 VDC/600 VAC | Contact Resistance | ≤ 20 mΩ at 100 mA |
| Rated current | 15A (UL) | | |
| Admissible Ambient Air Temp. | -40 °C to 125 °C | | |
| Material: Terminals | Brass, nickel-plated / tin-plated 1) | | |
| Storage Conditions | 0 °C to 50 °C, max. 70% r.h. | | |

¹⁾ Details see table of variants

Approvals and Compliances

Detailed information on product approvals, code requirements, usage instructions and detailed test conditions can be looked up in [Details about Approvals](#)

SCHURTER products are designed for use in industrial environments. They have approvals from independent testing bodies according to national and international standards. Products with specific characteristics and requirements such as required in the automotive sector according to IATF 16949, medical technology according to ISO 13485 or in the aerospace industry can be offered exclusively with customer-specific, individual agreements by SCHURTER.

Approvals

The approval mark is used by the testing authorities to certify compliance with the safety requirements placed on electronic products.

Approval Reference Type: CFO

| Approval Logo | Certificates | Certification Body | Description |
|---------------|------------------------------|--------------------|-------------------------|
| | UL Approvals | UL | UR File Number: E312155 |

Product standards

Product standards that are referenced

| Organization | Design | Standard | Description |
|--------------|-----------------------|----------------------|------------------------------|
| | Designed according to | UL 4248-1 | Industrial Control Equipment |
| | Designed according to | CSA C22.2 no. 4248.1 | Industrial Control Equipment |





Application standards

Application standards where the product can be used

| Organization | Design | Standard | Description |
|--|--------------------------------|----------------|---|
|  | Suitable for applications acc. | IEC/UL 62368-1 | Audio/video, information and communication technology equipment - Part 1: Safety requirements |

Compliances

The product complies with following Guide Lines

| Identification | Details | Initiator | Description |
|--|--|-------------|---|
|  | CE declaration of conformity | SCHURTER AG | The CE marking declares that the product complies with the applicable requirements laid down in the harmonisation of Community legislation on its affixing in accordance with EU Regulation 765/2008. |
|  | UKCA declaration of conformity | SCHURTER AG | The UKCA marking declares that the product complies with the applicable requirements laid down in the British Amendment of Regulation (EC) 765/2008. |
|  | RoHS | SCHURTER AG | Directive RoHS 2011/65/EU, Amendment (EU) 2015/863 |
|  | China RoHS | SCHURTER AG | The law SJ / T 11363-2006 (China RoHS) has been in force since 1 March 2007. It is similar to the EU directive RoHS. |
|  | REACH | SCHURTER AG | On 1 June 2007, Regulation (EC) No 1907/2006 on the Registration, Evaluation, Authorization and Restriction of Chemicals 1 (abbreviated as "REACH") entered into force. |

Dimension [mm]

Screw or rivet version M3

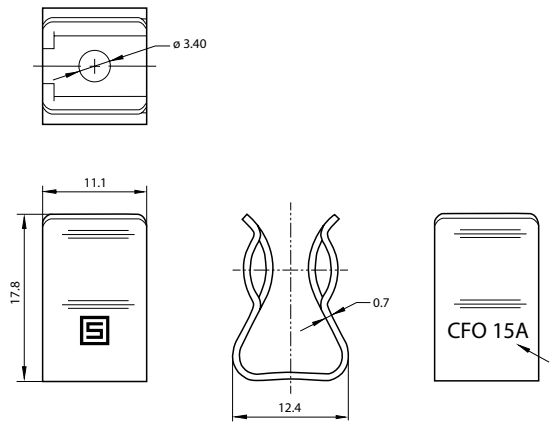
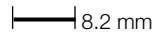

A= Current Rating