

# PNEUMATICS PRODUCTS



- › Logic elements
- › Position / Detectors
- › Electro-pneumatic valves





# CROUZET CONTROL



- For over 50 years, Crouzet Control, has established a reputation for providing micro-control products, micro-motors and position sensors. Read on to discover Crouzet Control's complete offer of Pneumatic products for industrial and explosive atmospheres.
- Always one step ahead of market trends and customer requirements, Crouzet Control is continually developing its range of both standard and customised automation components and solutions to cover all the latest commercial and industrial applications and meet the needs expressed by manufacturers of automated equipment and machinery.
- Throughout the world, Crouzet Control the adaptation specialist provides you with technical and industrial expertise to ensure seamless integration, whatever the equipment environment or operating requirements of the machine.

- **InnoVista Sensors™**: your trusted partner of choice to face industrial challenges of today and tomorrow.

*InnoVista Sensors™ is a worldwide industrial specialist of sensors, controllers and actuators for automated systems.*

*Through its brands, Crouzet Aerospace, Crouzet Automation, Crouzet Control, Crouzet Motors, Crouzet Switches and Systron Donner Inertial, InnoVista Sensors™ offers a wide range of reliable, efficient and customizable components dedicated to the Aerospace & Defence, Transportation and Industrial market and segments.*

*Thanks to the recognized expertise of its teams and a strong innovation policy, InnoVista Sensors™ brings performance enhancing solutions to its customers worldwide.*

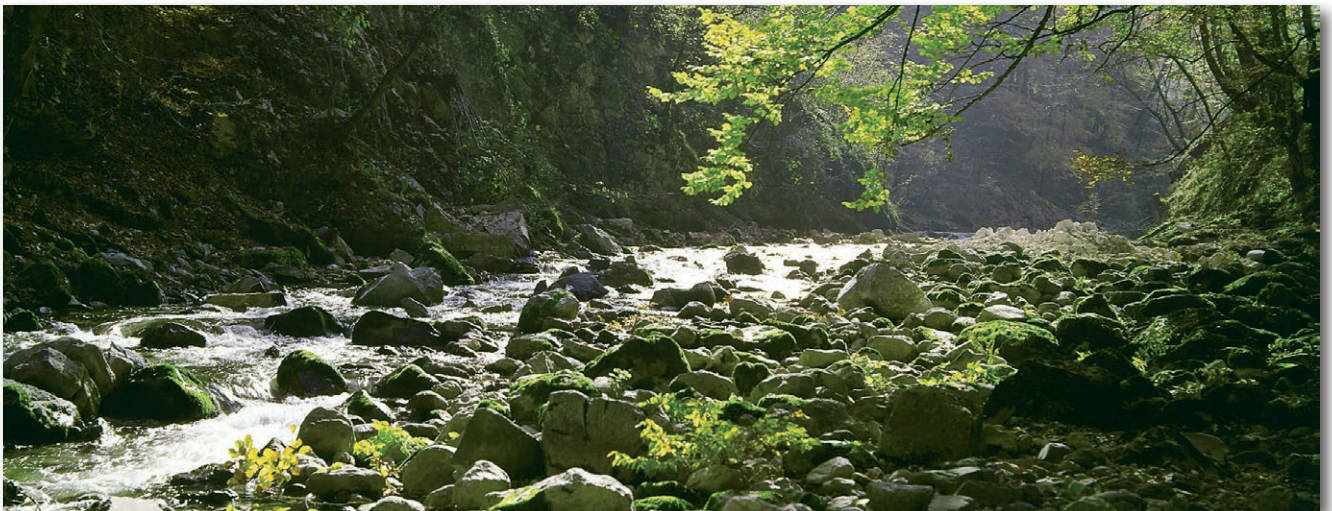

- *Eco-design is central to the company's "Offer Creation Process", the aim of which is to design products and services that correspond as closely as possible to customers' requirements and reduce their environmental impact throughout their life cycle.*
- Customer satisfaction will always be our prime objective.  
To this end, we rely on standards ISO 9001 and ISO14001 to ensure that our design, industrialisation, manufacturing and commercialisation processes correspond to our customers' requirements.

All Crouzet Control products are fully compliant with the RoHS directive



## ► Expertise - for all your applications

### ● **Crouzet Control's Pneumatic expertise**

provides you with an offer to meet all your automation system requirements, including systems for explosive atmospheres.

The quality of the Pneumatic components is based on a rigorous organisation which meets all current European and international directives, standards and approvals.

### ● **All our products are fully compliant** with the RoHS directive and embody an eco-design concept.

### ● The Pneumatic offer is the result of the implementation of Crouzet Control applications and expertise:

- **Listening to and analysing** your requirements
- **Expertise** in the associated applications: mechanical, electronic, sensors, etc.
- **Prototyping and industrialisation**
- **Tests**
- **Standardisation and certification** (IEC, EN, UL-CSA, ATEX, etc.)
- **Equipment** which is responsive and effective
- **International logistics** and after sales support.

### ● **Crouzet Control has developed broad expertise** in ensuring that your specific needs are taken into account.

Thanks to this expertise, we are continuously developing our standard products to create solutions tailored to your requirements.

### ► **Some relevant areas**

Water treatment, chemical factories, silos, gas storage, ports, refineries, paper industry, paint factories, vehicles (if used in ATEX conditions), etc.



## Pneumatic offer for use in industrial and explosive atmospheres

► This guide has been designed to help you quickly identify the appropriate products for your requirements. Most of our pneumatic components are available in a standard range and a range for use in explosive atmospheres (ATEX): this information is given in the right-hand column on each page.

### Industrial range

The standard range of pneumatic components is designed to meet requirements for industrial applications.

The operating characteristics (pressure, flow rate, service life, etc.) have been optimised to best meet these needs.



### Range for use in explosive atmospheres

The range for use in explosive atmospheres has been developed specifically for applications requiring compliance with European Directive 94/9/EC, the full details of which can be found on pages 30 and 31 of this guide.

The user is responsible for ensuring the compliance of his installations. All new installations must be compliant, and replacements in the event of breakdown or maintenance must comply with this directive.



### Characteristics of our ATEX components

- ATEX products are specifically marked in accordance with the latest versions of harmonised standards
- Every product is supplied with a guide specifying the usage restrictions in explosive atmospheres
- A copy of the approval certificate can be provided if requested at the time of order
- The order entry must state the usage conditions Crouzet Control states the usage restrictions on acknowledgements of receipt of order, delivery notes and invoices



### Crouzet Control has produced a separate catalogue for Pneumatic products for use in explosive atmospheres.

This catalogue gives details of the entire Crouzet Control range of ATEX pneumatic products along with associated standards, certifications, directives, markings and order conditions.



# ▶ ATEX Directive 94/9/EC: general information

## Principles of Directive 94/9/EC:

- The directive aims to harmonise the legislation of European Union member states in order to ensure free circulation of equipment intended for use in explosive atmospheres (gas and dust).
- Since 1 July 2003, this directive has applied to electrical, mechanical, hydraulic and pneumatic products.
- It concerns the assessment of protective devices and systems (manufacturers) as well as the design (design office), installation (installers, panel-builders) and maintenance (maintenance depts) of installations.

## Definition of an explosive atmosphere:

- An explosive atmosphere is defined as a mixture of flammable substances (in the form of gas, vapour, mist or dust) with air under atmospheric conditions in which, after ignition, combustion spreads throughout the entire unburned mixture.

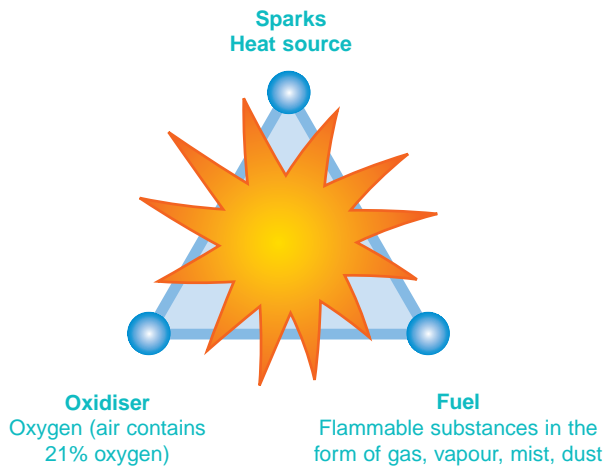

## Some relevant areas:



Water treatment



Chemical factories

Silos



Gas storage



Ports

- Refineries
- Paper industry
- Paint factories
- Vehicles (if used in ATEX conditions)

## Application since 30 June 2003:

- Manufacturers must offer products, which comply with Directive 94/9/EC and must have a Quality Control System that has been approved by a notified body.
- Users are responsible for using equipment correctly according to the zones they have defined within their installations based on the potential risks. Existing installations must be brought into conformity with the ATEX Directive before 30 June 2006. All new products commissioned must comply with Directive 94/9/EC. In the event of breakdown, installed equipment that cannot be repaired must be replaced with equipment complying with Directive 94/9/EC

## Classification:

- Potentially explosive environments are classified by zone in compliance with Directive 1999/92/EC. This directive is aimed at users. It details the minimum requirements for increasing protection of the health and safety of workers exposed to explosive atmospheres.
- ATEX Directive 94/9/EC defines categories of equipment and protection systems, which can be used in the corresponding zones.
  - ➔ Categories M1 and M2 relate to mines (group I)
  - ➔ Categories 1, 2 and 3 relate to other locations (group II) often referred to as "Surface industries"

## Documents and recommendations/products:

- ATEX-certified products must be supplied with an EC declaration of conformity and a user manual.
- At the time of sale, the sales representatives must check the zone in which the product is to be used. On the order, the customer must inform the manufacturer of the conditions of use.
- Manufacturers and distributors must ensure that their sales of ATEX products are traceable (so that customers who have been sold an ATEX product can be located in relation to the product's date of manufacture).
- In the case of an assembly, the product with the lowest certification level determines the level of the whole assembly.

### Equipment definition:

#### Equipment for surface industry - Group II

Zone	0	20	1	21	2	22
Type of atmosphere G = Gas, D = Dust	G	D	G	D	G	D
Presence of Explosive atmosphere	Continuous presence (or for long periods, i.e. more than 1000 hours per year)		Intermittent presence (or occasional, i.e. 10 to 1000 hours per year)		Fleeting presence (or rare, i.e. 1 to 10 hours per year)	
Category of equipment that can be used as per 94/9/EC dated 23/03/94	1		2		3	

### Marking example:

Certified products must incorporate marking specific to Directive 94/9/EC, such as:

Crouzet Automatismes SAS  
 2 rue du Docteur Abel, 26902 Valence, FRANCE  
 Type: 81513530  
 Serial no:  
 Year of construction  
**CE 0081** Ⓢ II 1 G  
**Ex ia II C T6**  
**LCIE 02 ATEX 6121 X**  
**Max. amb. T: +50°C**

### Explanation of the marking example:

- ➔ The CE marking along with the identification number of the notified body responsible for monitoring the QCS (0081 = LCIE).

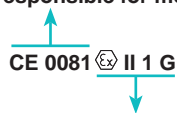

- ➔ The Ⓢ symbol indicating that this product can be used in an explosive atmosphere followed by the equipment group (II = Surface Industries), the category (1 = continuous presence; 2 = intermittent presence; 3 = fleeting presence), and the type of explosive atmosphere G = Gas, D = Dust.

In affixing this CE marking, the manufacturer declares that the product has been manufactured in complete conformity with the requirements of all the relevant directives.

- ➔ Next line of the marking specified by the harmonised standards:

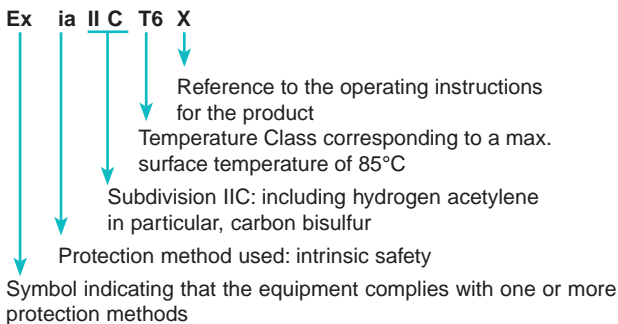

- ➔ The CE-Type Examination Certificate reference (if appropriate).

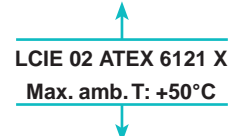

- ➔ The ambient operating temperature range.

In the event of use in an explosive atmosphere caused by dust, the following items are added to the marking:

- ➔ The surface limit temperature T° C for use in an explosive atmosphere caused by dust.
- ➔ The IP rating (only for dust)

## ▶ Examples of applications:

### ▶ Medical mattress

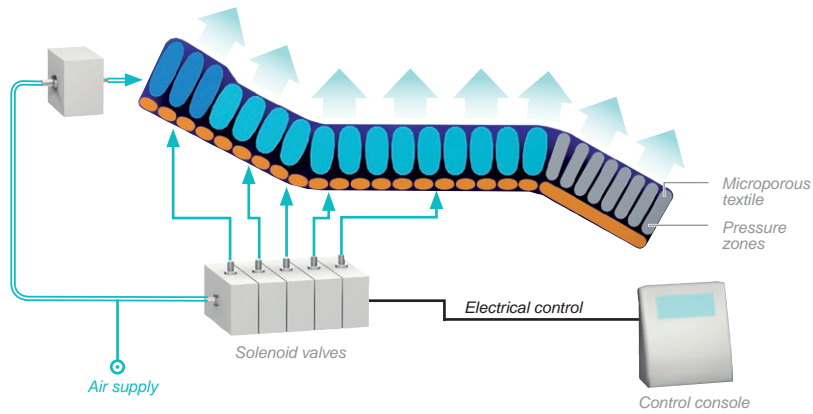

### ▶ Textile machine

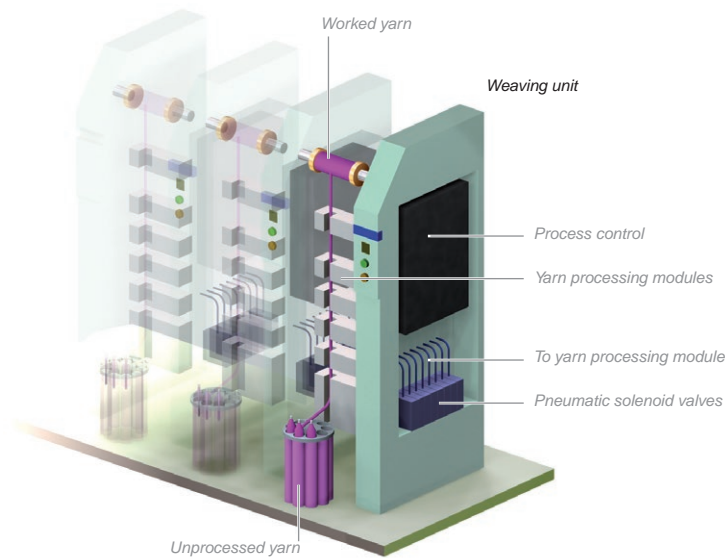

### ▶ Industrial valve

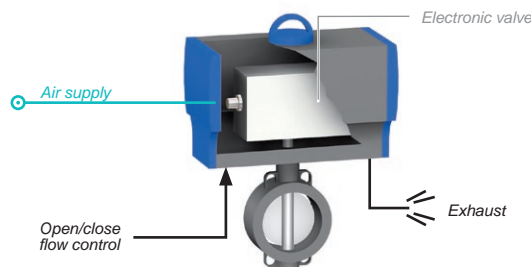

*Pneumatic actuators for quarter-turn or proportional taps and valves allow open/close commands and flow rate changes to be automated. The pneumatic actuating cylinder is operated by means of an air distributor valve built into the valve body and controlled by a solenoid valve.*

### ▶ Marking control system

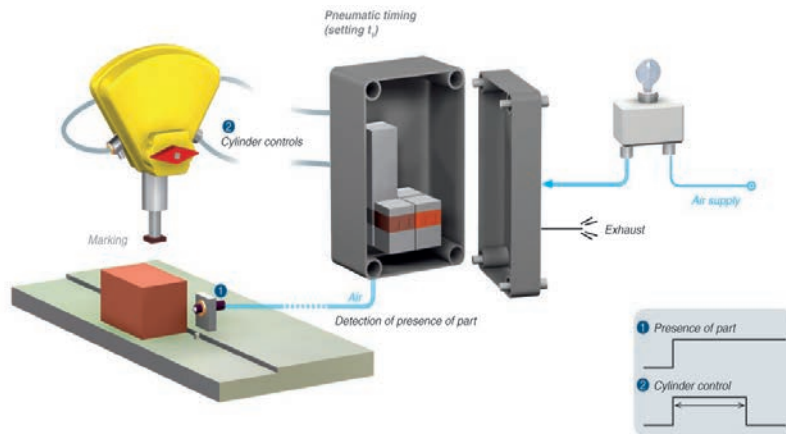

### ▶ Semi-automatic resin filling system, with anti-drip control

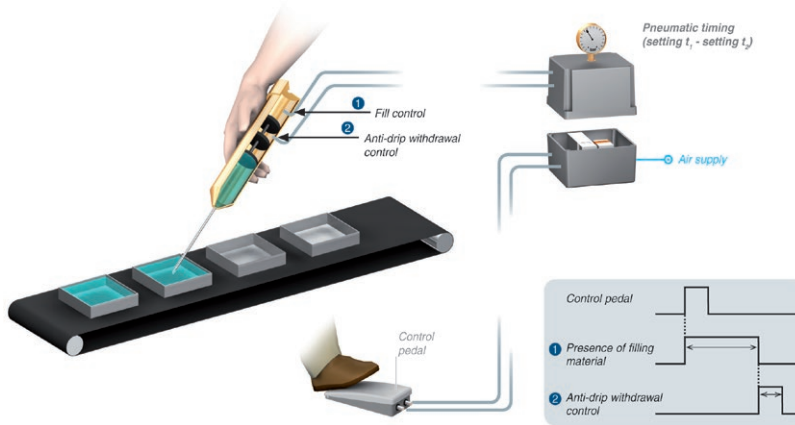

### ▶ Automatic assembly system

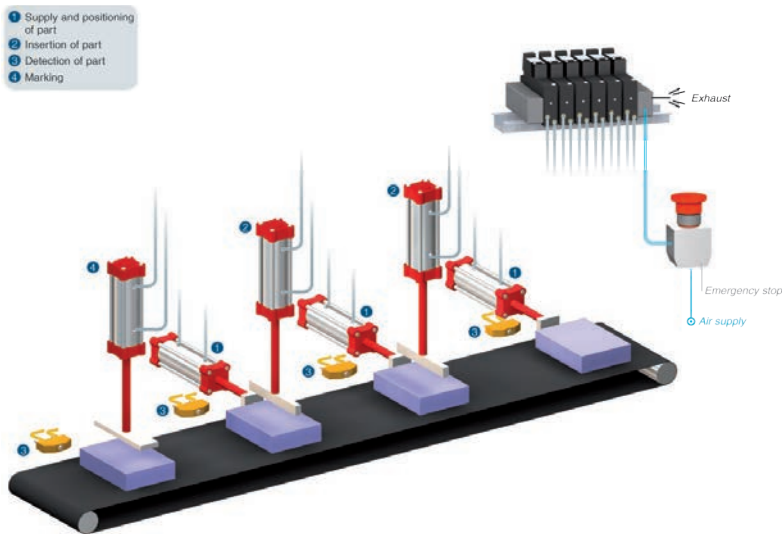



## ▶ Particular realizations

### ▶ Component on manifold mastered

---

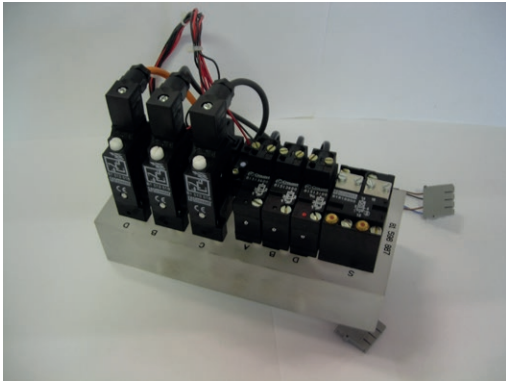

### ▶ Solenoid valves on manifold

### ▶ System for inflating

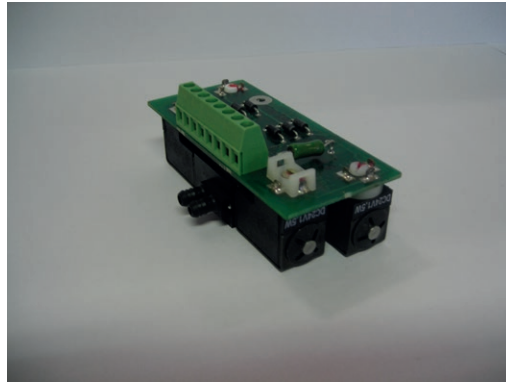
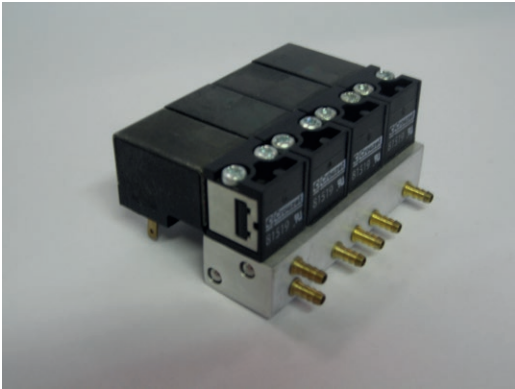

### ▶ Valves modules on manifold

---

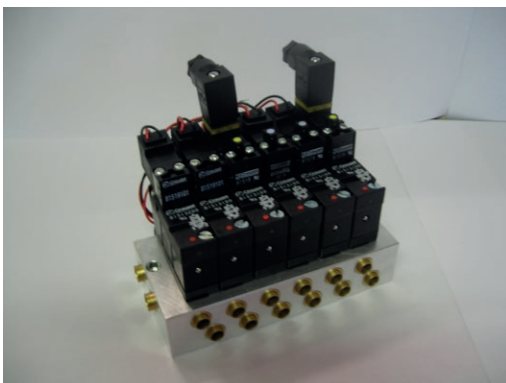

*For others configurations, consult us*

# General summary

Pages



***Manual actuated valves***

11



***Position detectors***

21



***Pressure switches - Vacuum***

35



***Pneumatic logic components***

41



***Electro-pneumatic control valves***

57



***Multi-fluid solenoid valves***

69



***Teaching materials***

72

# MANUAL ACTUATED VALVES

# Push buttons diameter 12 and actuators

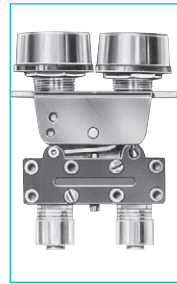
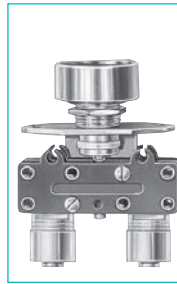

Features	Actuator color	Valve color	Push button round	Push button double round
Version	NC	black	81 735 511	—
		red	81 735 512	—
		black/red	—	81 733 511
	NO	black	81 735 011	—
		red	—	—
		black/red	—	—

## Symbol

NC

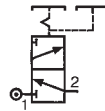
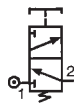

NO

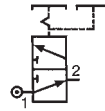
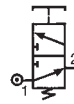

## Characteristics

Operating pressure	bar	2 → 8	2 → 8
Orifice diameter	mm	2.7	2.7
Flow at 6 bars	NI/mn.	200	200
Valves	NC : black NO : grey	● ●	●
Operating forces (depending on actuator)	N	8 → 18	8 → 18
Effective travel	mm	1	1
Fluid: dry or lubricated air		●	●
Push-in connectors for semi-rigid tubing (NFE 49100)	mm	Ø 4	Ø 4
Operating temperature	°C	-5 → +50	-5 → +50
Mechanical life	operations	1.5 x 10 <sup>6</sup>	1.5 x 10 <sup>6</sup>
Weight	g	35	40

## Dimensions

81 735

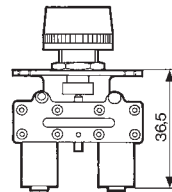

81 733

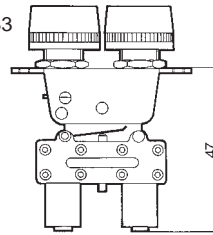

Threaded barrel

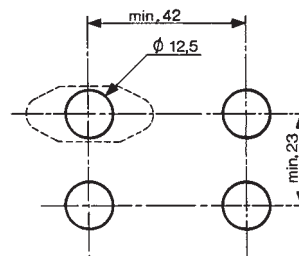

2 threaded barrels

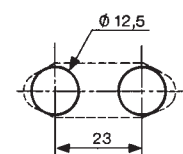

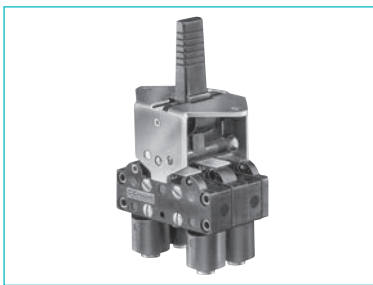

3-position lever  
manual return

81 716 511  
81 716 512

—	—
—	—
—	—
—	—

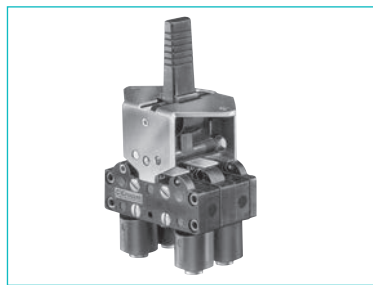

3-position lever  
spring return

81 715 511  
81 715 512

—	—
—	—
—	—
—	—

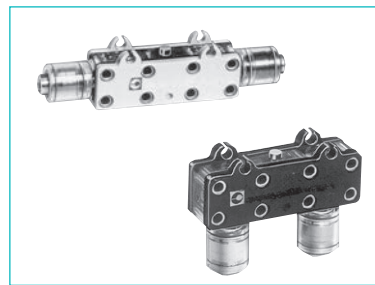

Horizontal outputs

Vertical outputs

81 280 510  
—

81 281 510  
—

81 280 010  
—

81 281 010  
—

—	—
—	—
—	—
—	—

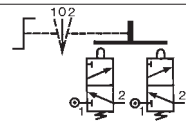
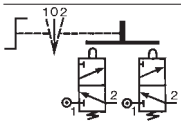

2 → 8  
2.7  
200

•	—
•	—
8 → 18	—
1	—
•	—

Ø 4  
-5 → +50  
1.5 x 10<sup>6</sup>  
65

2 → 8  
2.7  
200

•	—
•	—
8 → 18	—
1	—
•	—

Ø 4  
-5 → +50  
1.5 x 10<sup>6</sup>  
65

2 → 8  
2.7  
200

—	—
—	—
—	—
—	—
—	—

Ø 4  
-5 → +50  
1.5 x 10<sup>6</sup>  
14

2 → 8  
2.7  
200

—	—
—	—
—	—
—	—
—	—

Ø 4  
-5 → +50  
1.5 x 10<sup>6</sup>  
14

81 715 - 81 716

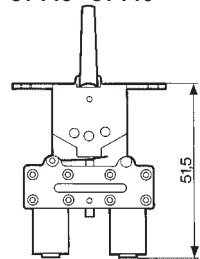

Square lever

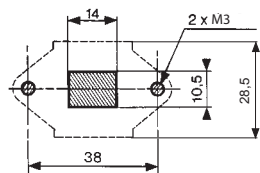

81 280 010 - 81 280 510

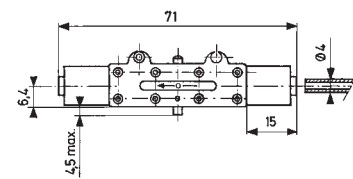

81 281 010 - 81 281 510

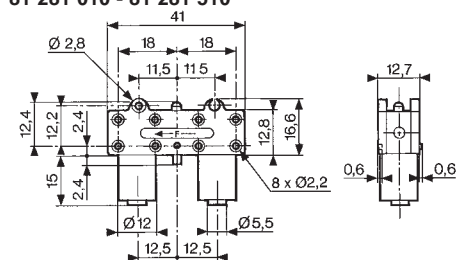

### 3/2 valves for manual actuators Ø 22 mm



3/2 valve supplied with screws for fixing the adaptator	Connection Ø4	89 543 501	89 543 101	—	—	—	—	—
	Gas 1/8	89 543 701	89 543 201	—	—	—	—	—
Valve(s) 3/2 fixed on adaptator (supplied with adaptator not assembled)	Connection Ø4	—	—	89 543 105	89 543 005	89 543 305	89 543 205	—
Adaptator for 3/2 valve on actuators Ø 22		—	—	—	—	—	—	24 679 702
Version		NC	NO	NC	NO	NC + NO	NC + NC	

**Symbol**

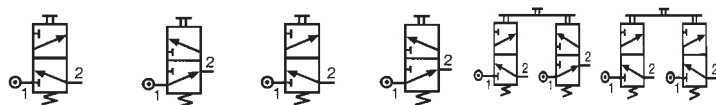

**Characteristics**

Operating pressure	bar	0 → 8	0 → 8	0 → 8	0 → 8	0 → 8	0 → 8	—
Orifice diameter	mm	2	2	2	2	2	2	—
Flow at 6 bars	NI/min	112	112	112	112	112	112	—
Control force	N	12.6	12.6	12.6	12.6	12.6	12.6	—
Operating temperature in dry air	°C	-5 → +60	-5 → +60	-5 → +60	-5 → +60	-5 → +60	-5 → +60	—
Life	operations	1.5 x 10 <sup>6</sup>	1.5 x 10 <sup>6</sup>	1.5 x 10 <sup>6</sup>	1.5 x 10 <sup>6</sup>	1.5 x 10 <sup>6</sup>	1.5 x 10 <sup>6</sup>	—
Non-connectable exhaust		●	●	●	●	●	●	—
Weight	g	50	50	60	60	110	110	40

**Principle of operation**

**NC version**

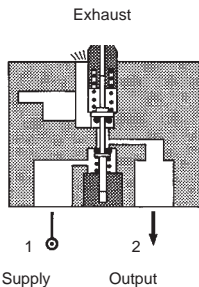

**Dimensions**

89 543 001 - 89 543 201  
89 543 501 - 89 543 701

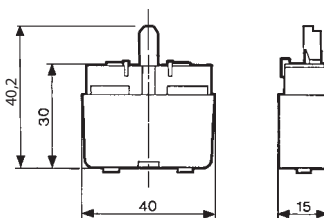

**Ø 22 series**

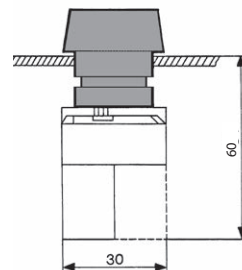

**Holes drilled in panel for actuators Ø 22**

**EN 50007**

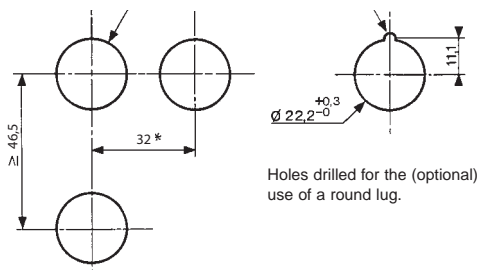



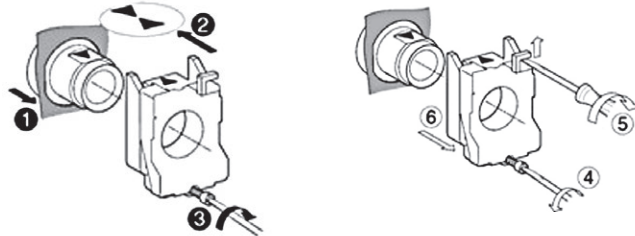

Holes drilled for the (optional) use of a round lug.

**Installation**



\* > 40 Ø 40 push-buttons  
\* > 45 for lever type rotary switches

## Actuators Ø 22 mm for manually operated valves

					
Push buttons	Red Green Black	24 678 129 24 678 128 24 678 127	24 678 173 — 24 678 172	24 678 171 — —	— — —
2-positions rotary switches		—	—	—	24 678 174
3-positions rotary switches		—	—	—	—
Function		Flush push contact	Emergency stop plastic Ø 40	Emergency stop Ø 40 mm push-turn	Black symmetrical actuator
					Long lever Black

### Symbol



### Position



Weight	g	30	45	45	45	45
--------	---	----	----	----	----	----

### Dimensions

24 678 127 - 24 678 128

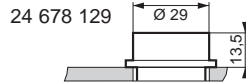

24 678 171 - 24 678 172

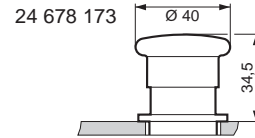

2-positions rotary switches	24 678 180	—	24 678 176	24 678 178	24 678 177	24 678 179	24 678 182	24 678 181
3-positions rotary switches	—							
Function	RONIS key 455 removable in position 0	Black symmetrical actuator	Black symmetrical actuator with return	Long lever Black	Black Long lever, spring to center	RONIS key 455 remov. in pos. 0 3 positions with spring to center	RONIS key 455 removable in position 0 3 fixed positions	

### Symbol

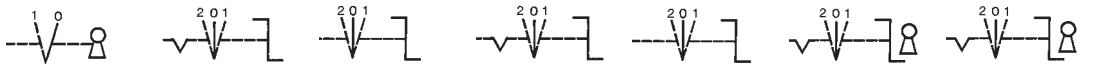

### Position

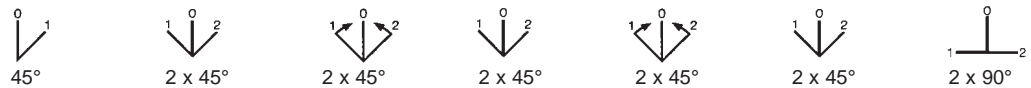

Weight	70	45	45	16	45	70	70
--------	----	----	----	----	----	----	----

### Dimensions

24 678 174 - 24 678 176

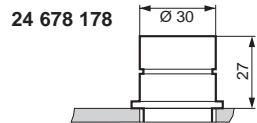

24 678 175 - 24 678 177

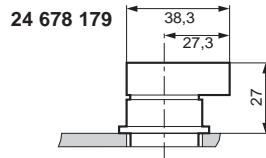

24 678 180 - 24 678 181

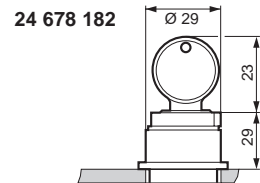

# Pneumatic 2-hand control

**Conforms to the Machinery Directive**



## Definition (conforming to EN 574 +A1)

A pneumatic 2-hand control device is used with dangerous machinery and requires the simultaneous use of both hands to trigger and maintain machine operation. Such a device must be located outside the dangerous zone, so that the operator cannot enter this zone before the machine has come to a complete standstill.

A pneumatic 2-hand control device is composed of 2 parts :

- 2 manual pushbuttons which require the simultaneous use of both hands.
- A pneumatic relay.

Types of 2-hand control devices

Requirements	Type				
	I	II	III		
			A	B	C
Use of both hands (simultaneous actuation)	●	●	●	●	●
Relationship between input signals and output signal	●	●	●	●	●
Cessation of the output signal	●	●	●	●	●
Prevention of accidental operation	●	●	●	●	●
Prevention of defeat	●	●	●	●	●
Reinitiation of the output signal		●	●	●	●
Synchronous actuation			●	●	●
Use of category 1 (EN 954-1)	●		●		
Use of category 3 (EN 954-1)		●		●	
Use of category 4 (EN 954-1)					●

- Category 1 (EN ISO 13849) :** the system should use well tried components and principles.
- Category 3 (EN ISO 13849) :** the system must be designed so that a single fault will not cause the loss of the safety function.
- Category 4 (EN ISO 13849):** the system must be designed so that an accumulation of faults must not lead to a loss of the safety function.

## Synchronous action

An output signal is only generated if both control actuating devices are actuated within 500 ms.

## Resetting the output signal

The release of a single control device interrupts the output signal, but a reset is only possible once both control devices have been released.



# Pneumatic relay for two-hand control

- › 100% pneumatic
- › Complies with Machinery Directive and the standard EN 574 +A1
- › CE Certification type-IIIA and IIIB

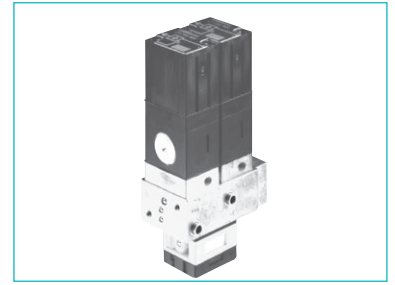

Pneumatic relay for two-hand control  
EN 574 +A1 classification

**81 580 101**  
III A

**81 580 202**  
III B

## Symbol

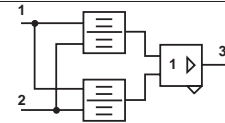

## Characteristics

Operating pressure	bar	2 → 8	2 → 8
Orifice diameter	mm	2.5	2.5
Max. delay between input signals	s	0.2 max.	0.2 max.
Connection		Sub-base 81 532 001	Semi-rigid tubing Ø 4 (NFE 49100)
Operating temperature	°C	-5 → +50	-5 → +50
Mechanical life	operations	10 <sup>7</sup>	10 <sup>7</sup>
Weight	g	90	320

## Principle of operation

**81 580 101**

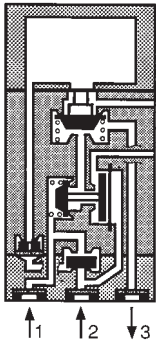

## Connections (Typical application with double-acting cylinder)

**81 580 101**

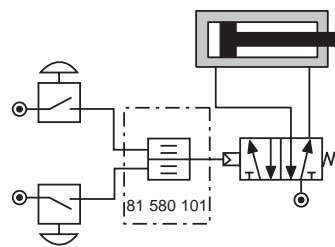

Components follow current standards

**81 580 202**

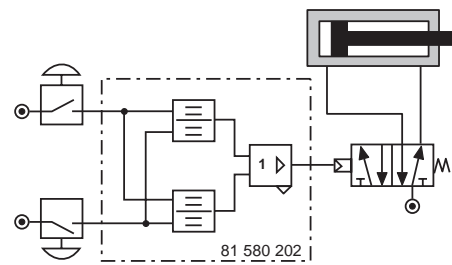

To obtain an output signal it is necessary to give simultaneous input signals 'a' and 'b' with a max. delay of 0.45. The output signal 's' is lost if one or both of the inputs are removed.

## Dimensions

**81 580 101**

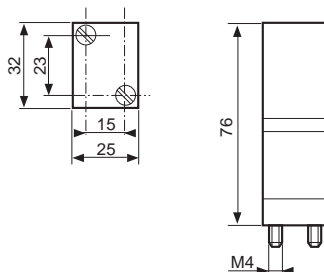

Mounted on sub-base 81 532 001  
(See page 55 of Pneumatic catalogue)

**81 580 202**

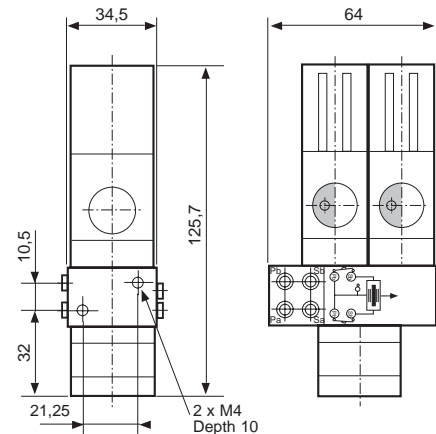

## Two-hand pneumatic safety start module

- › Conforms to the Machinery Directive and standard EN 574
- › Including pneumatic relay to classification IIIA or IIIB depending on version

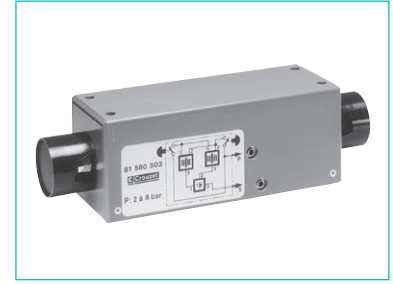
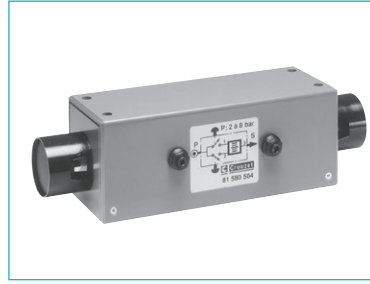

Two-hand pneumatic safety start module  
Pneumatic relay (to EN 574)

**81 580 504**  
Type III A

**81 580 503**  
Type III B

### Symbol

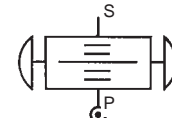
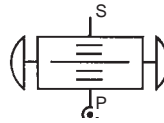

### Characteristics

Operating pressure	bar	2 → 8	2 → 8
Orifice diameter	mm	2.5	2.5
Max. delay between input signals	s	0.2 max.	0.2 max.
Connection		Semi-rigid tubing Ø 4 (NFE 49100)	Semi-rigid tubing Ø 4 (NFE 49100)
Operating temperature	°C	-5 → +50	-5 → +50
Mechanical life	operations	1.5 x 10 <sup>6</sup>	1.5 x 10 <sup>6</sup>
Weight	g	1000	1410

**Connections** (Typical application with double-acting cylinder)  
**81 580 504**

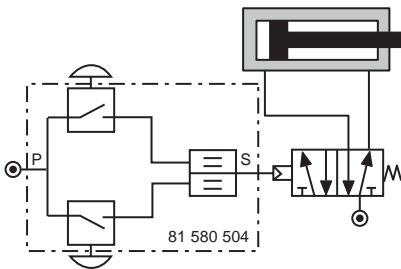

**81 580 503**

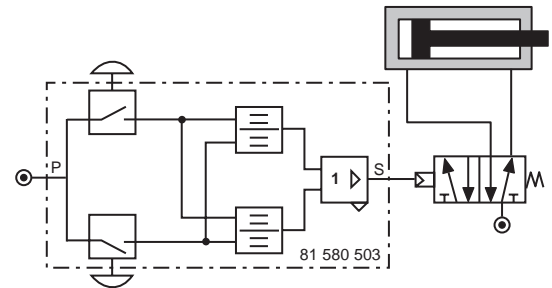

Components follow current standards

### Dimensions

**81 580 503 - 81 580 504**

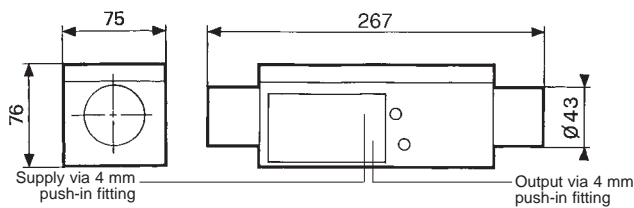

Fixing viewed from below

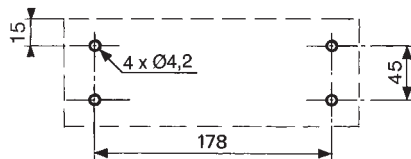

# Pneumatic impulse counters

- › 4, 5, 6 digits with or without reset
- › With or without pre-selection

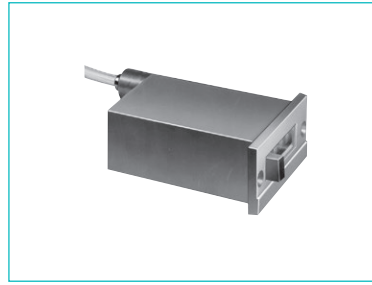

Totalizer	99 766 001	99 766 002	89 538 201
Preselection counter	—	—	—
Version	6 digits no reset to zero	4 digits with manual zero reset	5 digits with manual or pneumatic zero reset

## Symbol



## Characteristics

Supply pressure	bar	2 → 8	2 → 8	2 → 8
Pressure to break	bar	> 0.3	> 0.3	> 0.15
Pressure to make	bar	> 1.4	> 1.4	> 0.8
Reset :		—	—	2
Minimum pressure	bar	—	—	150
Reset time	ms	—	—	150
Circuit pressure	bar	—	—	2 → 8
Signal emitted when preset is reached		0 → +60	0 → +60	0 → +60
Operating temperature	°C	150	150	136
Weight	g	-	-	-

## Connection

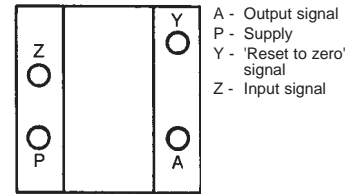

**Note :** the count pulse must be removed before the reset pulse is applied. The preset value can be changed during operation without the counter resetting to zero.

## Dimensions

Connectors for semi-rigid tubing Ø 4 (NFE 49100)

### 99 766 002

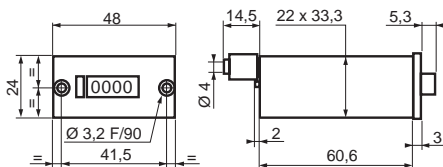

### 99 766 001

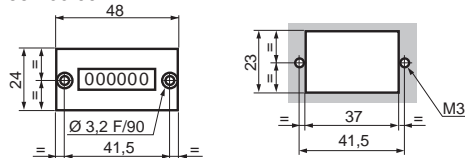

### 89 538 201

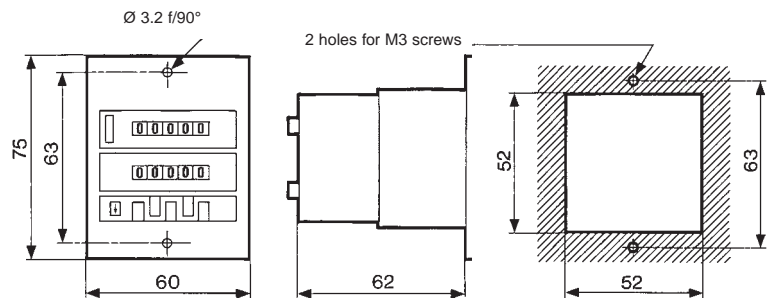

# Indicators and pedal valves

## Ergonomics



Also available in **ATEX** version for use in potentially explosive atmospheres in accordance with 94/9/EC Directive



Pneumatic indicators Ø 22	Red	84 150 201	—
	Green	84 150 202	—
	Yellow	84 150 203	—
	Blue	84 150 204	—
Pedal valve - Version NC		—	81 999 501

## Symbol

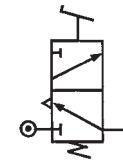

## Characteristics

Operating pressure	bar	2 → 8	—
Push-in connection for semi-rigid tubing (NFE 49100)	mm	Ø4	Ø4
Operating temperature	°C	-5 → +50	-5 → +50
Mechanical life	operations	10 <sup>7</sup>	1.5 x 10 <sup>6</sup>
Weight	g	34	290

## Dimensions

84 150 201 - 84 150 202  
84 150 203 - 84 150 204

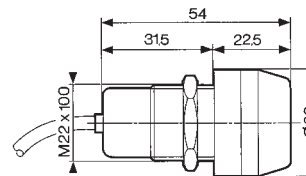

81 999 501

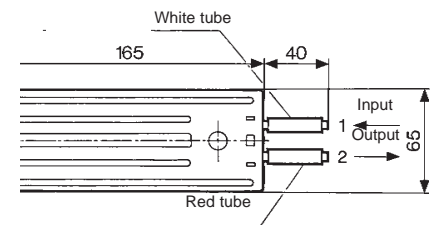

Holes drilled for indicators

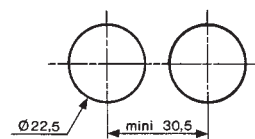

# POSITION DETECTORS

# Pressure decay sensor

› 100 % pneumatic

Also available in **ATEX** version for use in potentially explosive atmospheres in accordance with 94/9/EC Directive

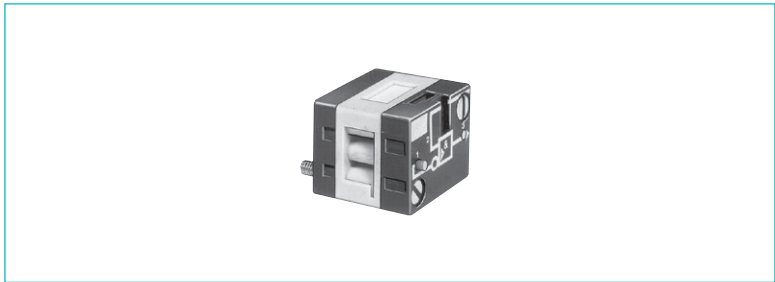

Pressure decay sensor

81 504 025

### Symbol



### Characteristics

Operating pressure	bar	2 → 8
Flow at 6 bars	NI/min	200
Tripping point with 6 bar supply	b	0.3
Connection		Sub-base page 54-55
Operating temperature	°C	-5 → +50
Mechanical life	operations	≥10 <sup>7</sup>
Weight	g	25

### Connections

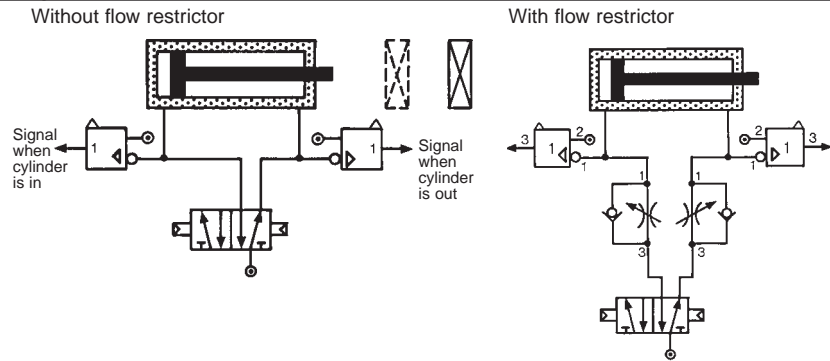

### Principle of operation

Fitted in-line between the cylinder and the control valve, the sensor will give an output when the pressure in this line is exhausted and the cylinder is at end of stroke.

For the correct usage of sensors on a falling pressure, it is recommended that the practical cylinder load is limited to 60% of the theoretical force.

Evolution of pressure within a double-acting cylinder

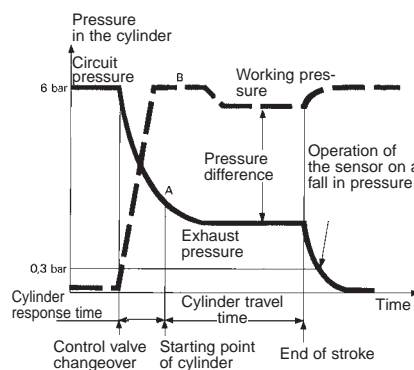

### Dimensions

81 504 025

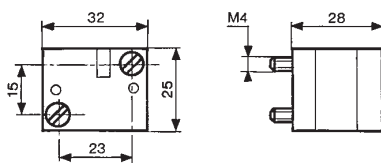

ATEX version products are available in the following catalogues: **Pneumatic products for explosive atmospheres** or on our website [www.crouzet-control.com](http://www.crouzet-control.com)

# Low force position detector

- › 100 % pneumatic
- › Conforme à la norme DIN 41365 Forme A
- › Faible effort d'actionnement < 50 g à 6 bars
- › Pas de consommation permanente d'air comprimé



Also available in **ATEX** version for use in potentially explosive atmospheres in accordance with 94/9/EC Directive

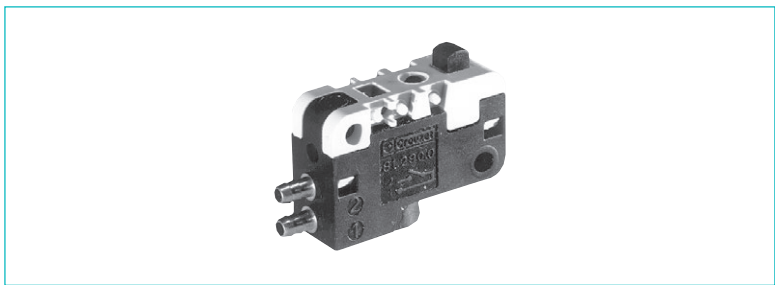

Function	NO
	NC

81 290 501	—
—	81 290 001

## Symbol

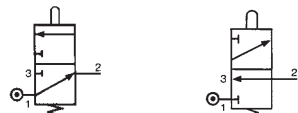

## Characteristics

Orifice diameter	mm	2	2
Operating pressure	bar	3 → 8	3 → 8
Flow at 4 bars	NI/min	100	100
Activation force at 6 bars	N	< 0,5	< 0,5
Permissible fluids (air / inert gas)		●	●
Max/min of fluid temperatures	°C	-10 → +50	-10 → +50
operating	°C	-10 → +60	-10 → +60
storage	°C	-40 → +70	-40 → +70
Mechanical life at 6 bars	operation	10 <sup>7</sup>	10 <sup>7</sup>
Response time	ms	≤ 15	≤ 15
on activation	ms	≤ 15	≤ 15
on release	ms	≤ 15	≤ 15
Barb connection for semi-rigid tubing		2.7 x 4	2.7 x 4
Weight	g	8.5	8.5

## Principle of operation NC

Desactivated

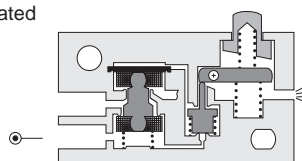

Activated

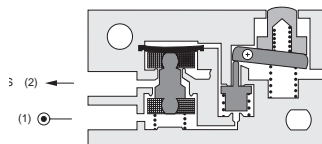

## Operation accessories

Unless otherwise requested, flat and roller-ended levers are supplied loose.

161 A  
flat R 25.4  
70 507 524

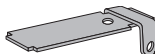

161 E  
with roller R 24.1  
70 507 529

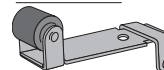

## Dimensions

DIN 41635 Form A

161 A  
R 25.4 ±0,2

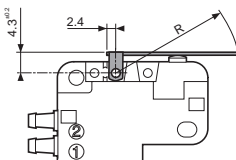

161 E  
R 24.1 ±0,2

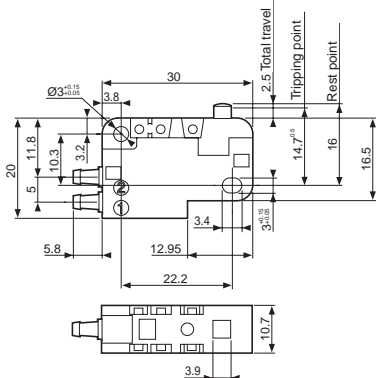
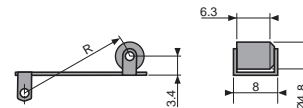

ATEX version products are available in the following catalogues: **Pneumatic products for explosive atmospheres** or on our website [www.crouzet-control.com](http://www.crouzet-control.com)

# “Microvalve” series position detectors

› 100 % pneumatic

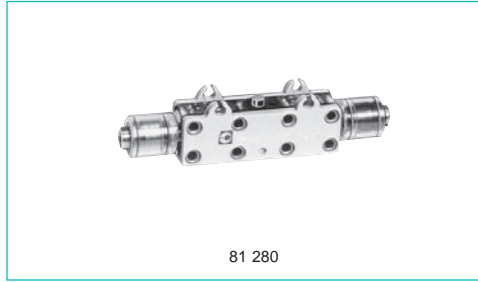

Version	NO	81 280 010	81 281 010	—
	NC	81 280 510	81 281 510	81 283 510
Features		Horizontal output	Vertical output	Rear connection by screw
Symbol				

NO



NC



## Characteristics

Operating pressure	bar	2 → 8	2 → 8	2 → 8
Orifice diameter	mm	2.7	2.7	
Flow at 6 bars	NI/min	200	200	138
Operating force at 6 bars	N	15	15	15
Effective travel	mm	1	1	1
Push-in connection for semi-rigid tubing (NFE 49100)	mm	Ø 4	Ø 4	Ø 4
Operating temperature	°C	-5 → +50	-5 → +50	-5 → +50
Mechanical life	operat.	5 x 10 <sup>6</sup>	5 x 10 <sup>6</sup>	5 x 10 <sup>6</sup>
Weight	g	14	14	20

## Principle of operation

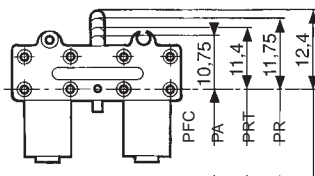

### Actuation positions :

- PFC : End of travel position
- PA : Operating position (max output kV)
- PRT : Release position (max. exhaust kV)
- PR : Rest position

NC

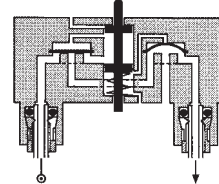

NO

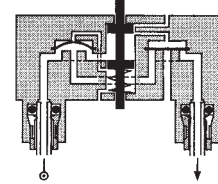

## Dimensions

81 281 010 - 81 281 510

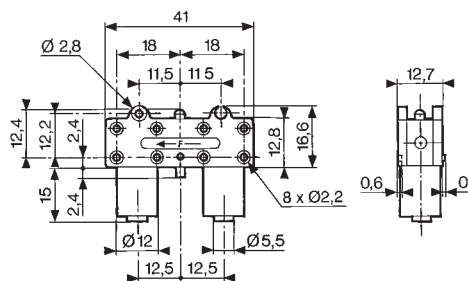

81 280 010 - 81 280 510

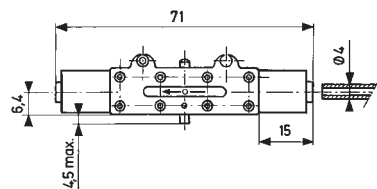

81 283 510

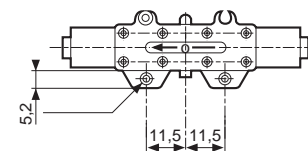



# “Microvalve” series position detectors

› 100 % pneumatic

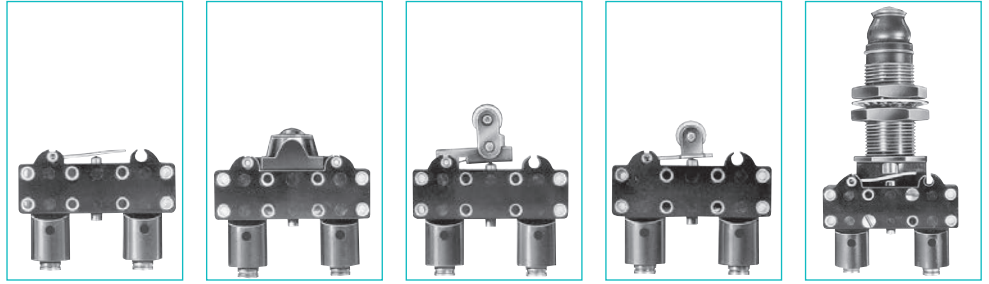

Features	Short lever	With ball	Roller trip	With roller	Threaded barrel Ø 16 Plunger
Version NC Vertical output	<b>81 281 502</b>	<b>81 281 504</b>	<b>81 281 508</b>	<b>81 281 509</b>	<b>81 737 501</b>

## Symbol

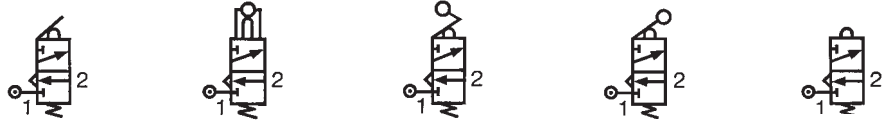

## Characteristics

Operating pressure	bar	2 → 8	2 → 8	2 → 8	2 → 8	2 → 8
Orifice diameter	mm	2.7	2.7	2.7	2.7	2.7
Flow at 6 bars	NI/min	200	200	200	200	200
Operating force at 6 bars	N	15	15	15	15	25
Effective travel	mm	1	1	1	1	1
Push-in connection for semi-rigid tubing (NFE 49100)	mm	Ø 4	Ø 4	Ø 4	Ø 4	Ø 4
Operating temperature	°C	-5 → +50	-5 → +50	-5 → +50	-5 → +50	-5 → +50
Mechanical life	operat.	5 x 10 <sup>6</sup>	5 x 10 <sup>6</sup>	5 x 10 <sup>6</sup>	5 x 10 <sup>6</sup>	5 x 10 <sup>6</sup>
Weight	g	16	18	18	18	90

## Dimensions

81 281 502

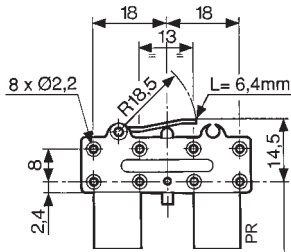

81 281 504

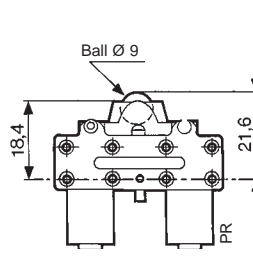

81 281 508

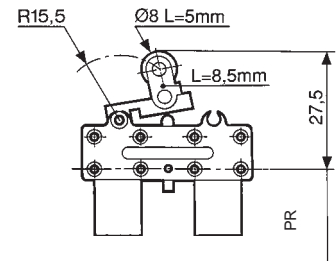

81 281 509

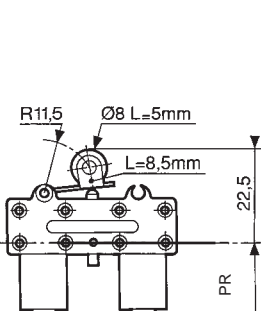

81 737 501

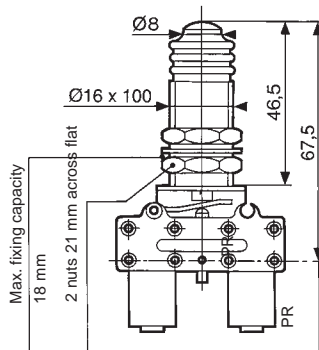

Actuation positions :  
PR : Rest position

# "Miniature" series position detectors

- › 100 % pneumatic
- › All metal

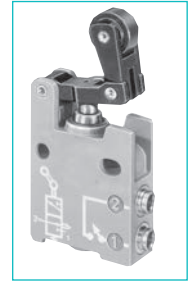
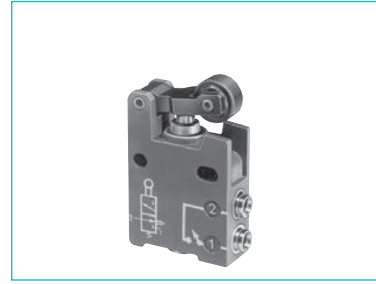
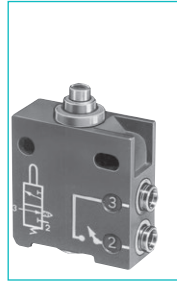

## Part numbers

Version	Push-in connection for semi-rigid tubing (NFE 49100)	81 921 501	81 921 701	81 921 702	81 921 707
NC	Ø 4 silenced exhaust	—	—	—	—
	M5 connectable exhaust	—	—	—	—
	Ø 4 connectable exhaust *	—	—	—	—
NO	Ø 6 connectable exhaust *	—	—	—	—
	Ø 4 silenced exhaust	—	—	—	—
Control	Ø 6 silenced exhaust	—	—	—	—
		Simple plunger	Lever with plastic roller	Lever with roller bearing	Lever with one-way trip plastic roller

## Symbol

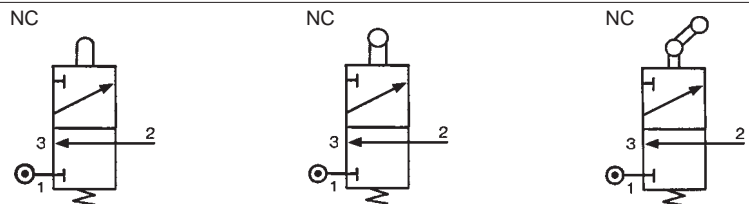

## Characteristics

Operating pressure	bar	0.1 → 8	0.1 → 8	0.1 → 8	0.1 → 8
Orifice diameter	mm	2.7	2.7	2.7	2.7
Flow at 6 bars	NI/min	200	200	200	200
Actuation force at 6 bars	N	18	18	18	18
Circuit function : NC		●	●	●	●
Circuit function: NO		—	—	—	—
Connectable exhaust		—	—	—	—
Operating temperature	°C	-5 → +50	-5 → +50	-5 → +50	-5 → +50
Mechanical life	operations	10 <sup>7</sup>	10 <sup>7</sup>	10 <sup>7</sup>	10 <sup>7</sup>
Weight	g	62	75	80	77

## Principle of operation

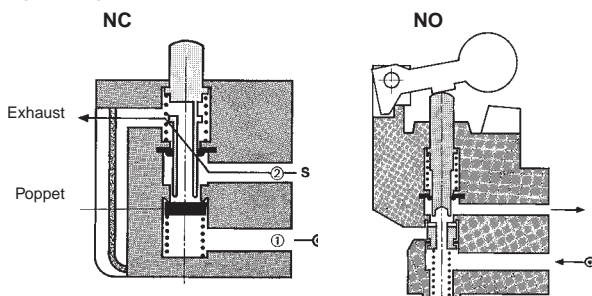

## Actuation travel Vertical attack Simple plunger

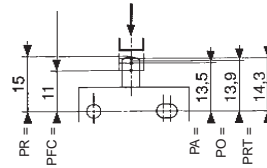

### Actuation positions :

- PA : Operating position (max output kV)
- PFC : End of travel position
- PO : Mid-position closed (no exhaust, no outlet)
- PRT : Release position (max exhaust kV)
- PR : Rest position

## Dimensions

### 81 921 501

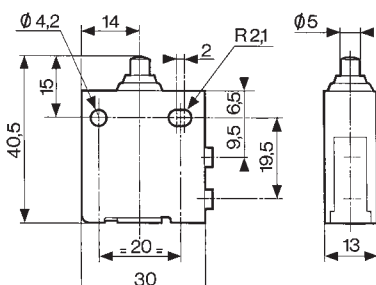

### 81 921 701 - 81 921 702

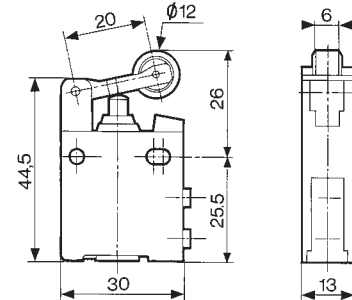

### 81 921 707

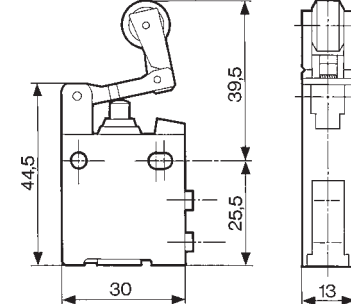

\* with barb for tube Ø 2.7 x 4

**Material: body zamak**

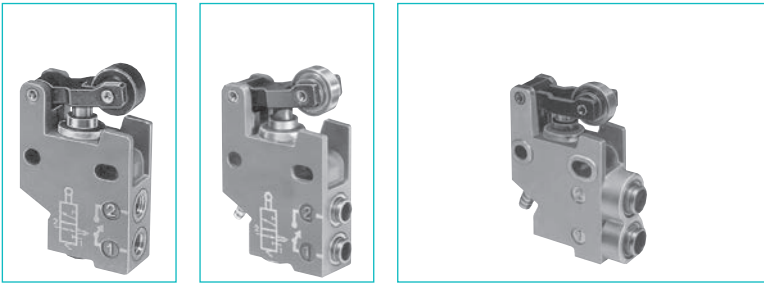

—	—	—	—
—	—	—	—
81 921 806	—	—	—
—	81 921 714	—	—
—	—	81 921 719	81 921 717
—	—	81 921 911	81 921 912
—	—	81 921 901	81 921 902
Lever with plastic roller	Lever with roller bearing	Lever with plastic roller	Lever with roller bearing

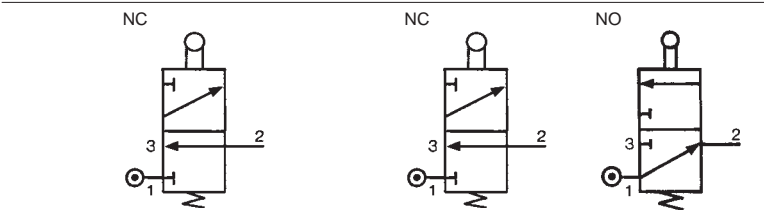

0.1 → 8	0.1 → 8	0.1 → 8	0.1 → 8
2.7	2.7	2.7	2.7
200	200	200	200
18	18	18	18
—	—	—	—
—	—	—	—
—	—	—	—
-5 → +50	-5 → +50	-5 → +50	-5 → +50
10 <sup>7</sup>	10 <sup>7</sup>	10 <sup>7</sup>	10 <sup>7</sup>
75	80	100	100

**Horizontal actuating 30° cam (other angles of attack are also possible, 45° even 90°).**

With lever

With lever

With lever

One-way trip lever

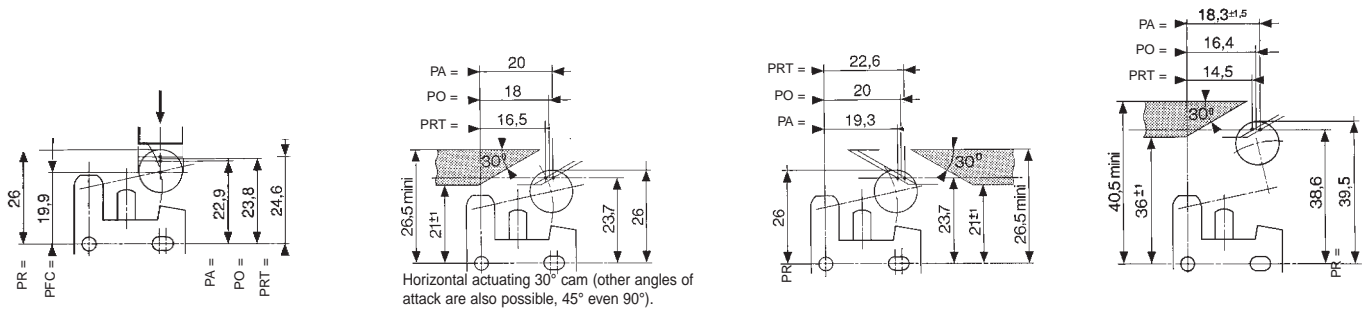

81 921 806

81 921 714

81 921 717 - 81 921 719  
81 921 901 - 81 921 902  
81 921 911 - 81 921 912

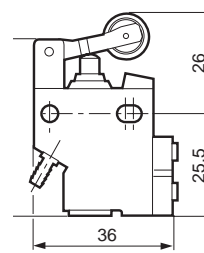
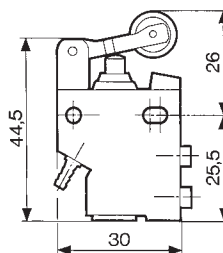
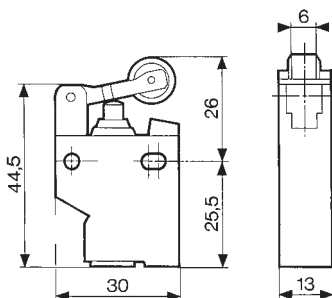

**Material: body zamak**  
**Other configuration on demand**

# "Compact" series position detectors

- › 100 % pneumatic
- › All metal

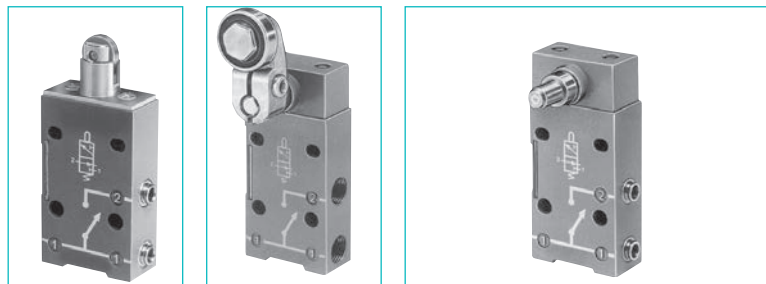

## Part numbers

Features	Direct acting 81 922 401	Rotary actuator 81 922 205	Rotary actuator 81 922 010	Rotary actuator 81 922 210
Version	Roller plunger with unthreaded barrel	Right-hand rotary head with roller lever (CNOMO)	Programmable rotary head without lever	Programmable rotary head without lever

## Symbol

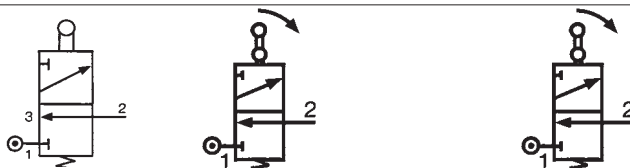

## Characteristics

Connection	BSP	mm	—	1/8	—	1/8
	push-in for semi-rigid tubing (NFE 49100)		Ø 4	—	Ø 4	—
Operating pressure	bar		0.1 → 8	0.1 → 8	0.1 → 8	0.1 → 8
Bore diameter	mm		3	3	3	3
Flow at 6 bars	Nm³/h		200	200	200	200
Activation force at 6 bars	daN		2.5	2.5	2.5	2.5
Circuit function:	NC		•	•	•	•
Mechanical life	operations		> 10 <sup>7</sup>	> 10 <sup>7</sup>	> 10 <sup>7</sup>	> 10 <sup>7</sup>
Silenced or connectable (1/8) exhaust			•	•	•	•
Operating temperature	°C		-5 → +50	-5 → +50	-5 → +50	-5 → +50
Weight	g		150	193	175	175

## Accessories

Accessories	Material	Part number	81 922 401	81 922 205	81 922 010	81 922 210
Lever with roller	plastic	79 452 103	—	•	•	•
	bearing	79 452 104	—	•	•	•
Lever with adjustable roller	plastic	79 452 123	—	•	•	•
	bearing	79 452 124	—	•	•	•
Adjustable steel rod lever		79 452 133	—	•	•	•

## Principle of operation

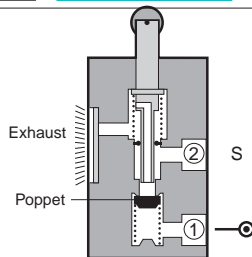

### Vertical attack

Detectors with roller plunger with unthreaded barrel.

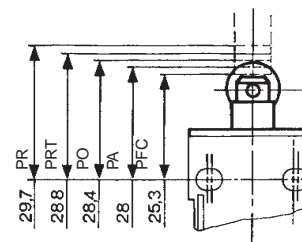

#### Actuation positions :

- PA : Operating position (max output kV)
- PFC : End of travel position
- PO : Mid-position closed (no exhaust, no outlet)
- PRT : Release position (max exhaust kV)
- PR : Rest position

The detectors 81 922 010 and 81 922 210 can operate to both left and right.

**Material: body zamak**

**Other configuration on demand**

### Horizontal attack

Detectors with roller plunger with unthreaded barrel.

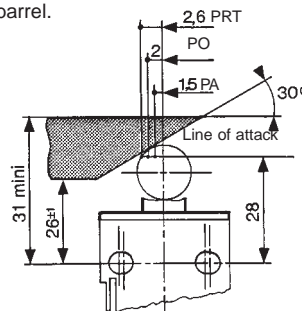

**Rotary actuator**

Detectors with levers

81 922 - 81 922 0 - 81 922 2

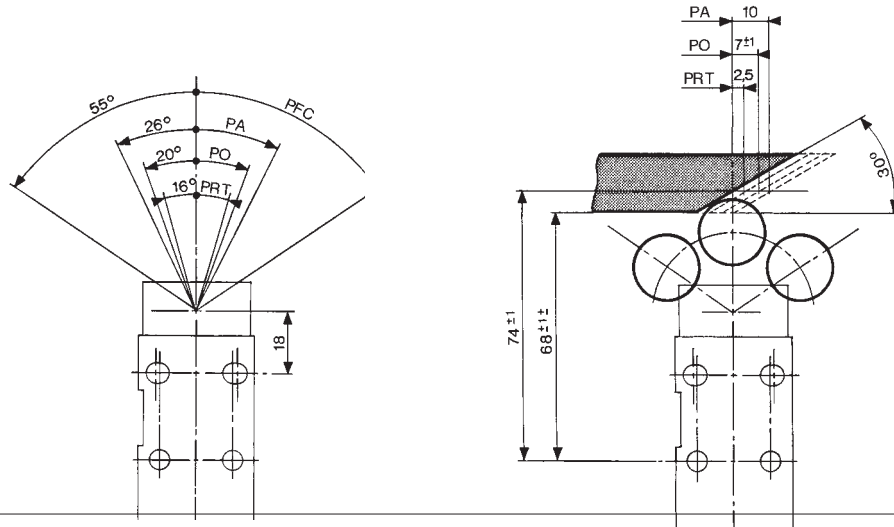

**Dimensions**

81 922 401

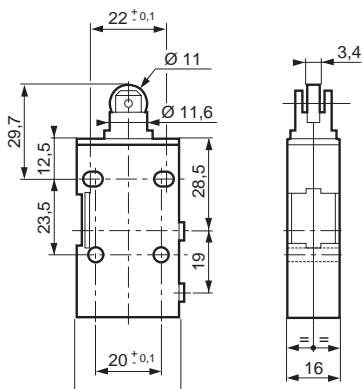

81 922 205 - 81 922 0 - 81 922 2  
79 452 103 - 79 452 104

79 452 123 - 79 452 124

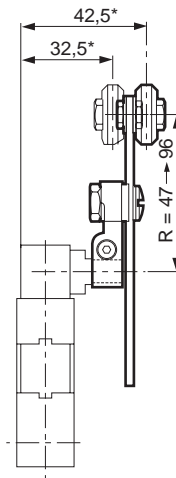

79 452 133

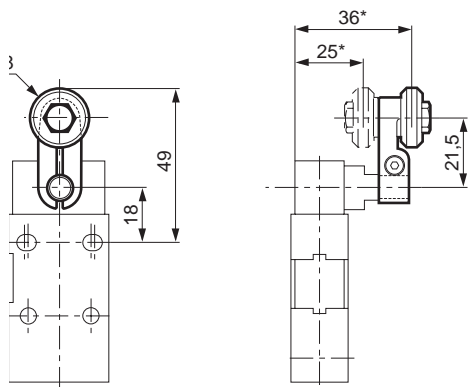
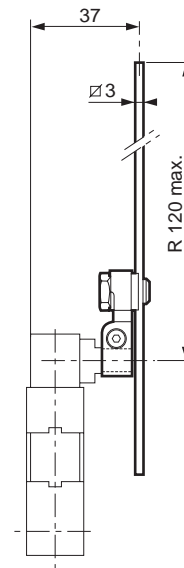

# "Adjustable stop" series position detectors

- › 100 % pneumatic
- › All metal

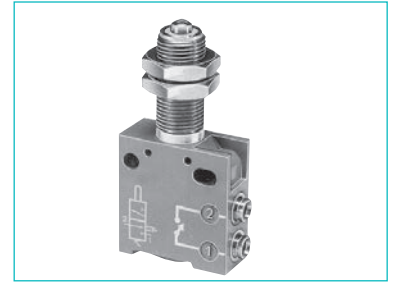
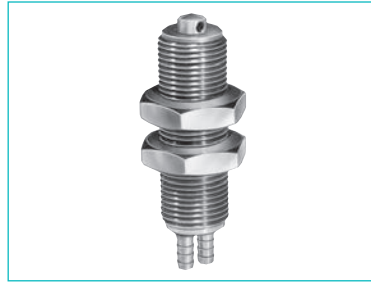

## Part numbers

Push-in connection for semi-rigid tubing (NFE 49100)

**81 923 001**

Barb for tube 2.7 x 4

**81 921 505**

Push-in connector for tube Ø 4

## Symbol

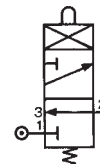
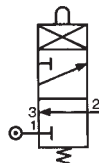

## Characteristics

Operating pressure	bar	0,1 → 8	0,1 → 8
Orifice diameter	mm	2	2,7
Flow at 6 bars	NI/min	130	200
Actuation force at 6 bars	N	16	21
Circuit function: NC		•	•
Max. load: without shock	daN	1000	1000
Will stop a 63 mm Ø cylinder : 6 bar supply		•	•
Operating temperature	°C	-5 → +50	-5 → +50
Mechanical life	operations	10 <sup>7</sup>	10 <sup>7</sup>
Weight	g	27	90
Actuation positions			
PA : Operating position (max output kV)	mm	0,4	0,7
PFC : End of travel position	mm	0	0
PO : Mid-point closed (no exhaust, no outlet)	mm	0,9	1
PRT : Release position (max. exhaust kV)	mm	1,5	1,5
PR : Rest position	mm	3	3

## Principle of operation

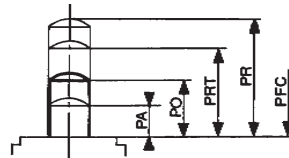
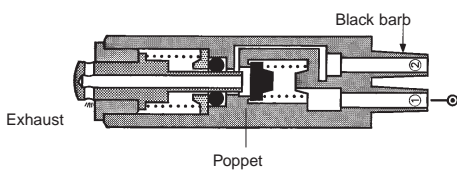

Versions	PO	PA	PFC	PRT	PR
With barb	0.9	0.4	0	1.5	3
Ø 4	1	0.7	0	1.5	3

Values in mm

### Actuation positions :

- PA : Operating position (max output kV)
- PFC : End of travel position
- PO : Mid-position closed (no exhaust, no outlet)
- PRT : Release position (max exhaust kV)
- PR : Rest position

## Dimensions

81 923 001

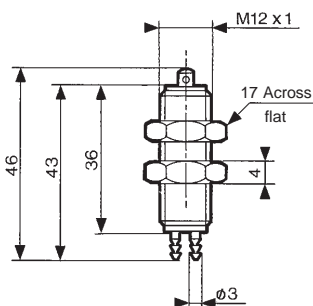

81 921 505

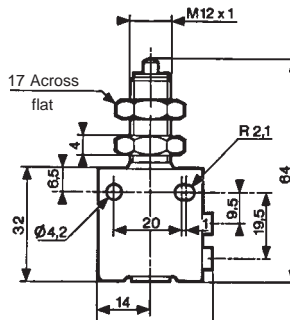

## Fixing

This should be as close as possible to the plunger

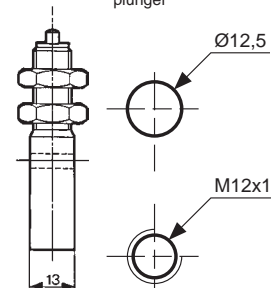

Material: body zamak

# Position detectors use with relay

- › 100 % pneumatic
- › All metal
- › Low force operation <N 1
- › Very low force Version 30 mN

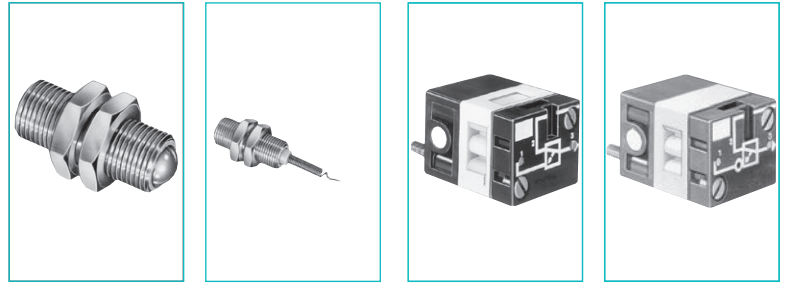

## References

Version	81 512 201 with ball	81 512 401 with wire	81 502 435 Positive	81 505 435 Negative
---------	-------------------------	-------------------------	------------------------	------------------------

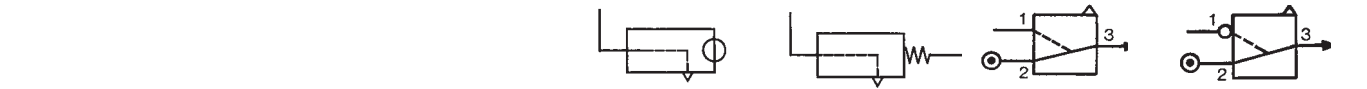

## Characteristics

Push-in connection for semi-rigid tubing (NFE 49100)	mm	Ø 4	Ø 4		
Life at 6 bars	operations	10 <sup>7</sup>	10 <sup>7</sup>		
Actuation force at 6 bars	N	0,8	0,025		
Fluid used: that delivered by the leak sensor relay..		•	•		
Operating temperature	°C	-5 → +50	-5 → +50	-5 → +50	-5 → +50
Weight	g	24,5	23,5	35	35
Operating pressure	bar			2 → 8	2 → 8
Sensor consumption for relay supply at 6 bar	NI/			5	5
The distance between relay and sensor must be less than 15 m for a tube Ø 2.7 x 4 mm				•	•
Connection - sub-base see pages 54/55				•	•
Mechanical life	operations			10 <sup>7</sup>	10 <sup>7</sup>

## Connection

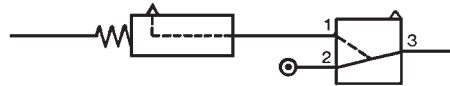

## Principle of operation

Supplied at industrial pressure, the relay produces a permanent bleed at its input port. A sensor shutting off this bleed causes the relay to switch.

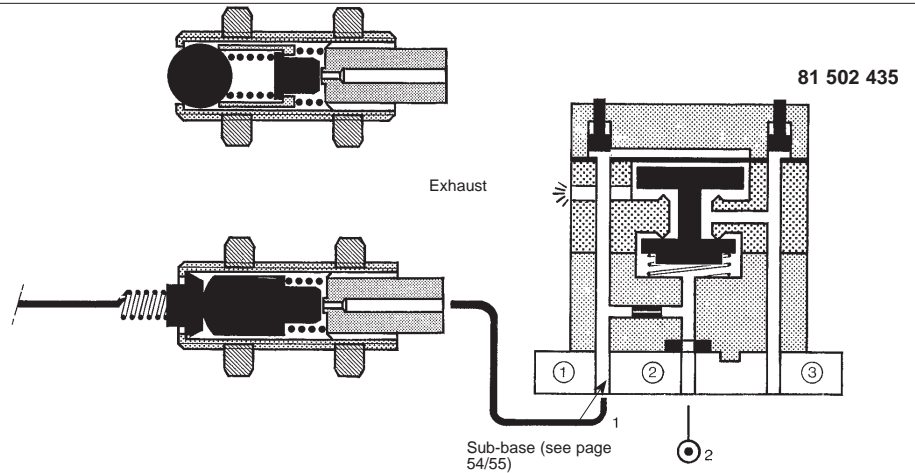

## Dimensions

81 512 201

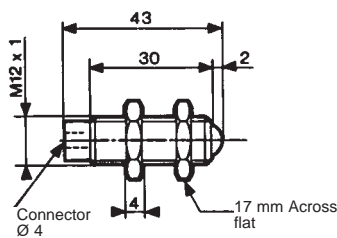

81 512 401

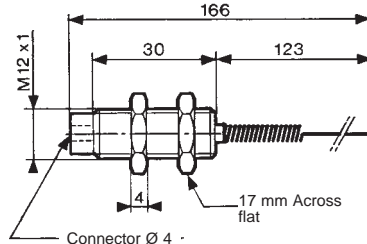

81 502 435 - 81 505 435

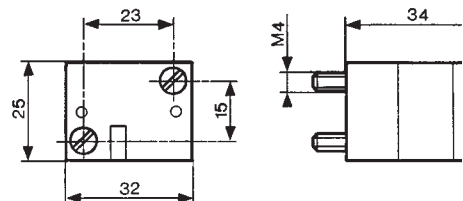

Material: brass

# Position detectors

- › 100 % pneumatic
- › All metal
- › Gap, proximity, paddle

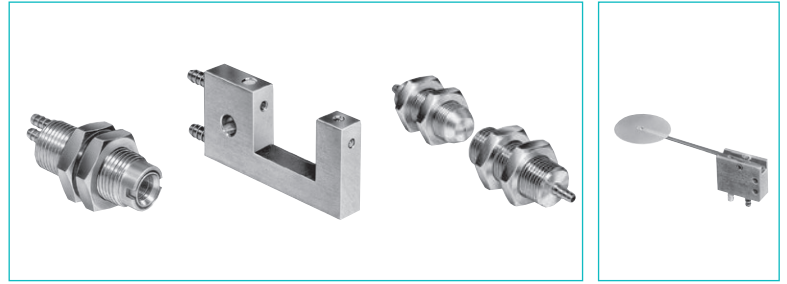

## Part numbers

	81 371 401	81 372 201	81 372 401	81 372 901
Detector	de proximité	gap	gap	with palette
Symbol				

## Characteristics

Detection distance	mm	6 → 10	18	100	—
18 mm gap sensor		—	—	—	—
Supply pressure	bar	0.5 → 2.5	0.5 → 2.5	0.5 → 2.5	—
Minimum output pressure	mbar	1	5	5	—
Unlimited life (static component)		●	●	●	—
Operating temperature	°C	- 20 → +70	- 20 → +70	- 20 → +70	—
Consumption at supply pressure of:	NI/h	800	70	100	—
2.5 b	NI/h	2500	2200	700	—
Barb connection for semi-rigid tubing (NFE 49100)	mm	Ø 2.7 x 4	Ø 2.7 x 4	Ø 2.7 x 4	Ø 2.7 x 4
Operating pressure	nozzle sensor	—	—	—	2 → 8
	d. detection 200 mm	—	—	—	2 → 8
	d. detection 100 mm	—	—	—	1 → 4
Flow	nozzle at 2 bars	NI/h	—	—	320
	sensor at 2 bars	NI/h	—	—	320
	at 2 bars	N	—	—	0.03
	at 6 bars	N	—	—	0.09
Sensor consumption for relay supply at 6 bars	NI/min	—	—	—	5
Weight	g	36	9	63	14

## Principle of operation

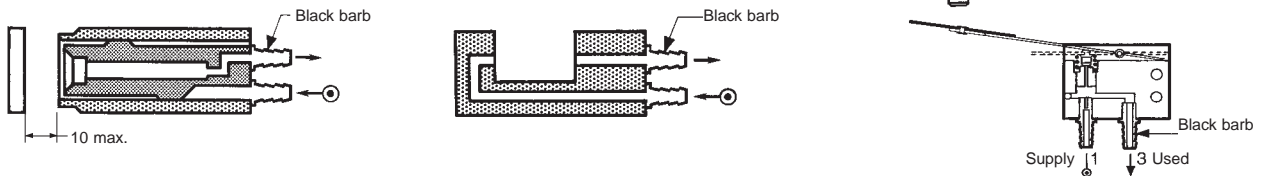

## Connection

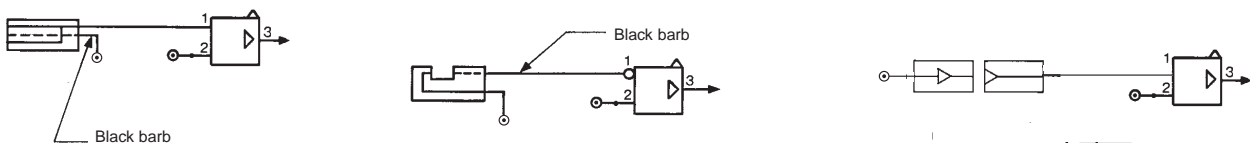

## Encombremments

### 81 371 401

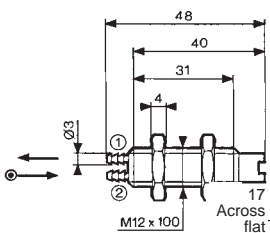

### 81 371 201

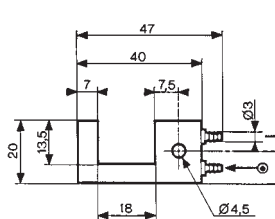

### 81 372 401

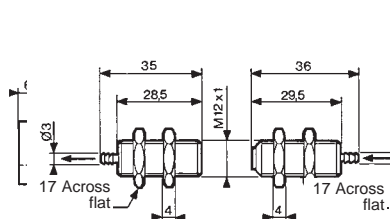

### 81 372 901

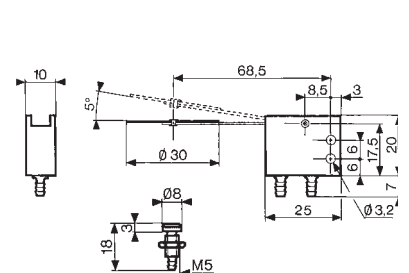



# Amplifiers for mounting on installation plan

## › Gap sensor

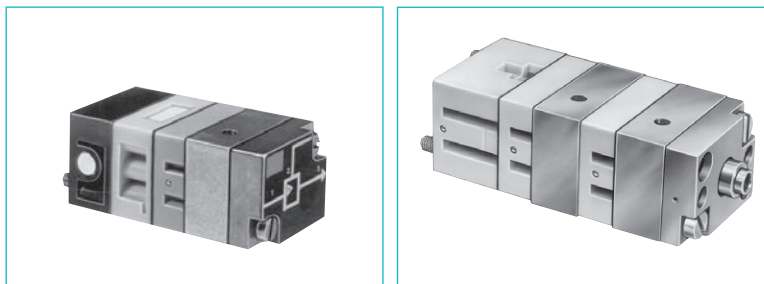

Also available in **ATEX** version for use in potentially explosive atmospheres in accordance with 94/9/EC Directive

### Part numbers

Simple amplifiers (for 81 372 201/401)	<b>81 502 230</b>	<b>81 505 230</b>	—	—
Sensitive amplifiers (for 81 371 401)	—	—	<b>81 502 320</b>	<b>81 505 320</b>
Version	positive	negative	positive	negative

### Symbol



### Characteristics

Pressure to make	mb	10 → 20	10 → 20	1 → 4	1 → 4
Operating pressure (non-lubricated air)	bar	2 → 8	2 → 8	2 → 6	2 → 6
Orifice diameter	mm	2.5	2.5	2.5	2.5
Average consumption at 4 bars	Nl/min	5	5	5	5
Permissible overload for 1 hour	mb	800	800	800	800
Operating temperature	°C	-5 → +50	-5 → +50	-5 → +50	-5 → +50
Mechanical life	operations	3 x 10 <sup>6</sup>	3 x 10 <sup>6</sup>	3 x 10 <sup>6</sup>	3 x 10 <sup>6</sup>
Weight	g	150	150	185	185

### Connections

Used for gaps up to 25 mm.  
The supply to the sensor should be made via a pressure regulator or one-way flow restrictor (see page 52)  
Connection - sub-base

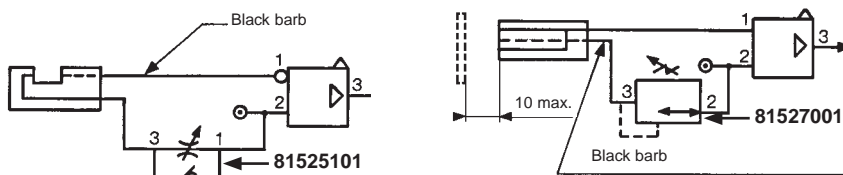

### Principle of operation

#### Simple amplifiers

An output at normal industrial pressure is delivered on a low pressure input.  
NB: Hysteresis is 20% of the pilot pressure.

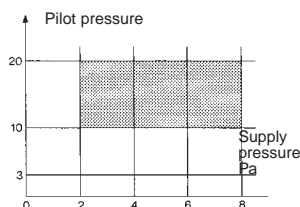

81 502 230

Positive output

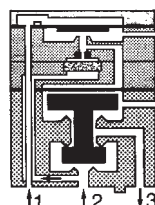

81 505 230

Negative output

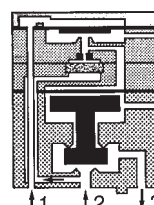

1- pilot  
2- supply  
3- output

#### Sensitive amplifiers

An output at normal industrial pressure is delivered on a very low pressure input.

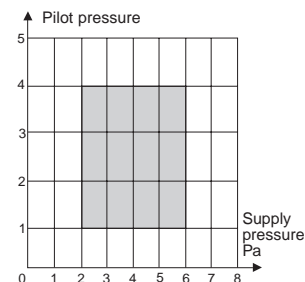

81 502 320

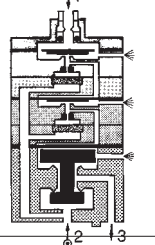

81 505 320

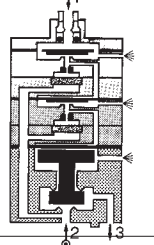

### Dimensions

81 502 238 - 81 505 231

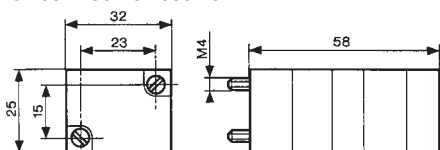

81 502 322 - 81 505 321

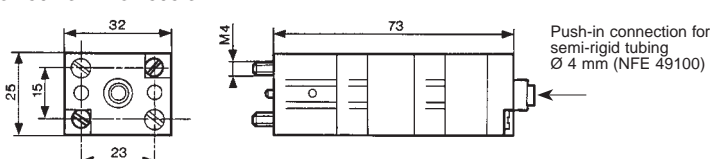

### Other information

With gap sensors, use an amplifier with negative output if you require a signal on interruption of the jet.

ATEX version products are available in the following catalogues: **Pneumatic products for explosive atmospheres** or on our website [www.crouzet-control.com](http://www.crouzet-control.com)

# Amplifier with intégral régulateur, positive output

- › Setting Flow
- › Fixing rail 35mm wide



Part numbers	
Amplifiers with integral regulator	<b>81 510 001</b>
Version	Positive output
Symbol	

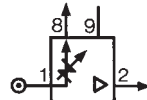

Characteristics				
Pressure to make	mb	0.5 → 1.5	—	—
Reduced pressure supplied at port 8	bar	0.5 → 2.5	—	—
Flow through port 8	Nm³/h	0.1 → 2.5	—	—
Consumption of amplifier only	NI/h	100 → 200	—	—
Permissible overload for 1 hour	mb	300	—	—
Operating temperature	°C	-5 → +50	-5 → +50	-5 → +50
Mechanical life	operations	3 x 10 <sup>6</sup>	3 x 10 <sup>6</sup>	3 x 10 <sup>6</sup>
Weight	g	380	—	—
Detectors (see page 28)		Proximity	Gap	Proximity
		Ø 12	Ø 18	Ø 12
		81 371 401	81 372 201	81 372 401
Min. total consumption for detection (0.5 b regulated pressure)	NI/h	8	18	100
Max. total consumption for short response time (2.5 b regulated pressure)	NI/h	880	140	—
Min. detectable	NI/h	2750	400	920
dimensions	nominal sensing distance	mm	Ø 3	Ø 2 - Ø 1.5
Max. frequency of use	2	mm	2	—
Force exerted by the jet on the parts to be detected	Hz	5	5	5
	N	0.02 → 0.7	0.01 → 0.03	0.1

### Connection

To use with detectors page 32

### Principle of operation

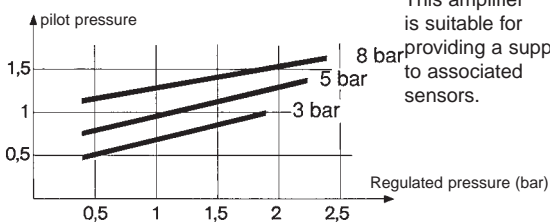

### Dimensions

Push-in connection for semi-rigid tubing Ø 4 mm (NFE 49100)

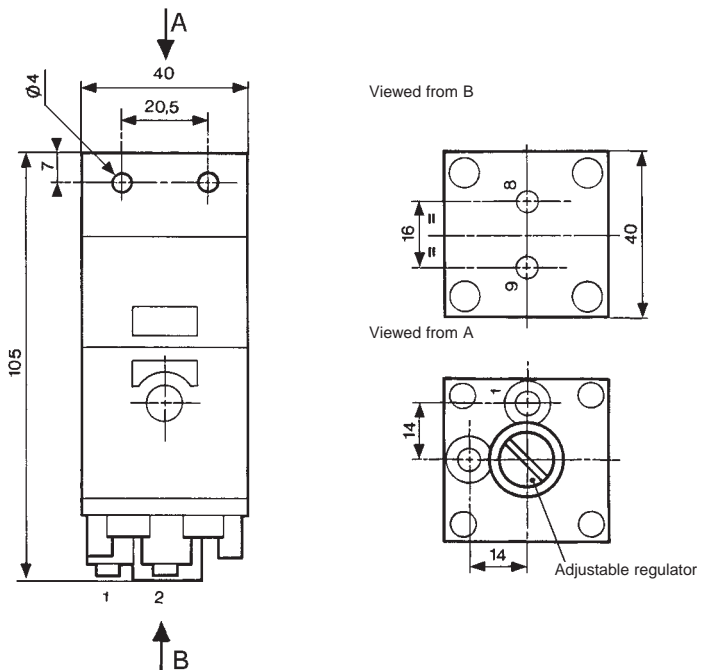

# **PRESSURE SWITCHES**

# **VACUUM**

# Pressure switches - vacuum (electrical output)

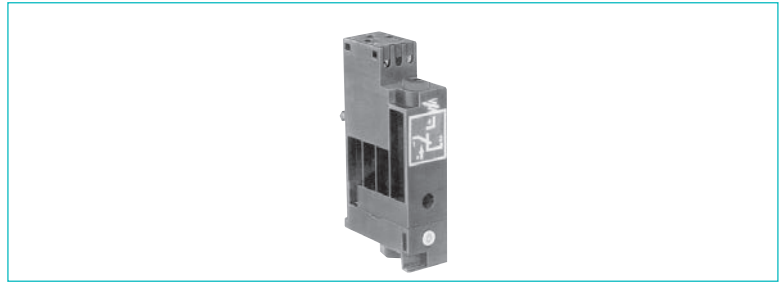

- › Conform to the Low Voltage Directive
- › Can be used without enclosure according to IEC 664-1 pollution group III

### Part numbers

Pressure and vacuum switches	<b>81 513 552</b>	<b>81 513 502</b>	<b>81 513 501</b>	<b>81 513 522</b>
Mounting	DIN rail	DIN rail	DIN rail	DIN rail
Actuators	Pressure	Pressure	Low pressure	Vacuum
Manual override	with	without	without	without

### Symbol

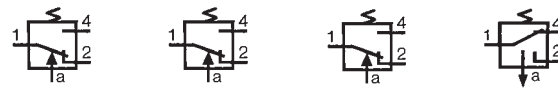

### Characteristics

Pneumatic connection	Push-in connection for semi-rigid tubing (NFE 49100) Tapped BSP via connector	mm	Ø 4 ext.	Ø 4 ext.	Ø 4 ext.	Ø 4 ext.
Protection	IEC 529		IP 20	IP 20	IP 20	IP 20
Permissible fluid: air, inert gases and liquids			•	•	•	•
Adjustment of switching pressure (* adjusted to 0.3)	bar		2 → 8	2 → 8	0.3 → 1.2 *	-0.3 → -0.8
Hysteresis	bar		0.5	0.5	—	—
at 1 bar	bar		0.6	0.6	—	—
at 2 bars	bar		0.8	0.8	—	—
at 4 bars	bar		1	1	—	—
at 6 bars	bar		—	—	•	—
max. 200 mb			—	—	—	•
max. 250 mb			—	—	—	—
Pressure to break			—	—	—	—
Mechanical life (operations)			10 <sup>6</sup>	10 <sup>6</sup>	10 <sup>6</sup>	10 <sup>6</sup>
Contact rating (V resistive)			5A - 220-230 V	5A - 220-230 V	5A - 220-230 V	5A - 220-230 V
Wire cross-section	mm <sup>2</sup>		0.75	0.75	0.75	0.75
Operating temperature	°C		-10 → +70	-10 → +70	-10 → +70	-10 → +70
Weight	g		48	46	46	46
Standard electrical contact			V4 83 170 4 I W2	V4 83 170 4 I W2	V4 83 170 4 I W2	V4 83 170 4 I W2
UL and cUL approval			MH15213 (R)	MH15213 (R)	MH15213 (R)	MH15213 (R)

### Operation

Pressure operated

Vacuum operated

### Electrical life

(Crouzet microswitch "V4" ref 83 170 4-1-W2)

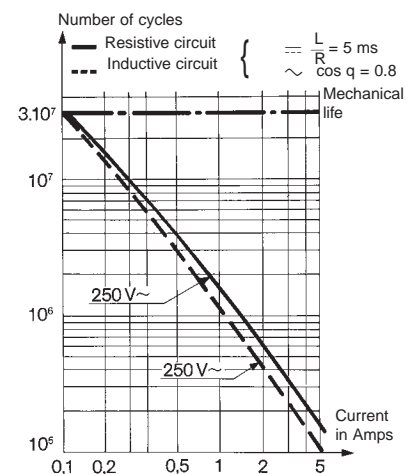
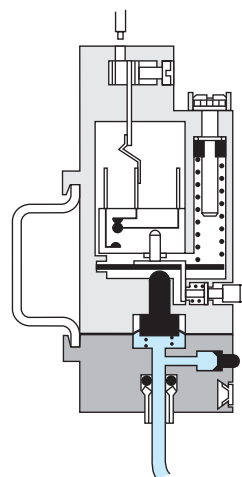
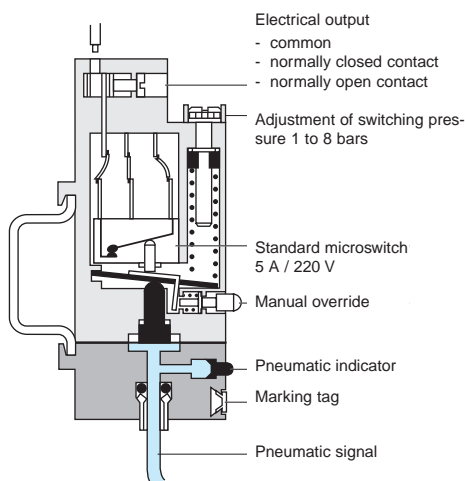

For continuous vacuum applications, please consult us.

### Other information

On request :

- Microswitch V4 ref. 83 170 0 i W2 high current
- Microswitch V4 ref. 83 170 9 i W2 low current

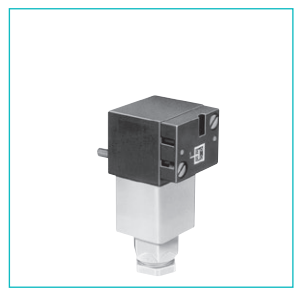
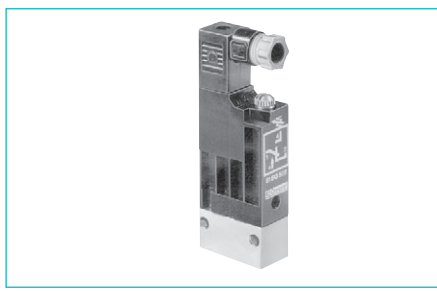
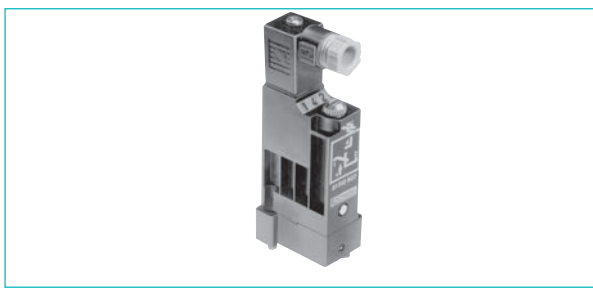

<b>81 513 516</b>	<b>81 513 510</b>	<b>81 513 527</b>	<b>81 513 533</b>	<b>81 513 523</b>	<b>81 509 080</b>	<b>81 509 085</b>
Base mounted page 4/14	Base mounted page 4/14	Base mounted page 4/14	2 screws M4	2 screws M4	Base mounted page 4/14	Base mounted page 4/14
Pressure without	Pressure with	Vacuum without	Pressure without	Vacuum without	Pressure without	Pressure with

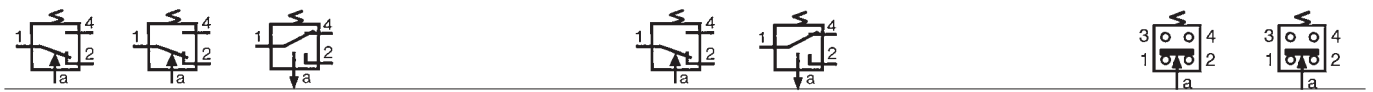

Ø 4 ext.	Ø 4 ext.	Ø 4 ext.	—	—	—	—
IP 54	IP 54	IP 54	1/8 BSP IP 54	1/8 BSP IP 54	Via sub-base IP 54	Via sub-base IP 54
2 → 8	2 → 8	-0.3 → -0.9	2 → 8	-0.3 → -0.8	1.4 ± 0.5	1.4 ± 0.5
0.5	0.5	—	0.5	—	—	—
0.6	0.6	—	0.6	—	—	—
0.8	0.8	—	0.8	—	—	—
1	1	—	1	—	—	—
—	—	—	—	—	—	—
—	—	—	—	—	—	—
10 <sup>e</sup>	10 <sup>e</sup>	10 <sup>e</sup>	10 <sup>e</sup>	10 <sup>e</sup>	0.6 ± 0.2 10 <sup>e</sup>	0.6 ± 0.2 10 <sup>e</sup>
5A - 220-230 V	5A - 220-230 V	5A - 220-230 V	5A - 220-230 V	5A - 220-230 V	5A - 220-230 V	5A - 220-230 V
0.75	0.75	0.75	0.75	0.75	1.5	1.5
-10 → +70	-10 → +70	-10 → +70	-10 → +70	-10 → +70	-10 → +70	-10 → +70
56	58	56	65	65	80	80
V4 83 170 4 I W2	V4 83 170 4 I W2	V4 83 170 4 I W2	V4 83 170 4 I W2	V4 83 170 4 I W2	83 133 004	83 133 004
MH15213 (R)	MH15213 (R)	MH15213 (R)	MH15213 (R)	MH15213 (R)		

**Electrical connections**  
**81 513 501 - 81 513 502**  
**81 513 522 - 81 513 552**

**Dimensions**  
**81 513 552 - 81 513 502**  
**81 513 501 - 81 513 522**

Pressure switch with connector  
**81 513 516 - 81 513 510**  
**81 513 527**

**81 516 082**  
**81 513 533**  
**81 513 523**

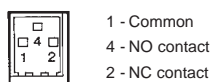

**81 513 510**  
**81 513 516 - 81 513 527**

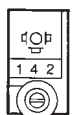

**81 513 533**  
**81 513 523 - 81 513 533**

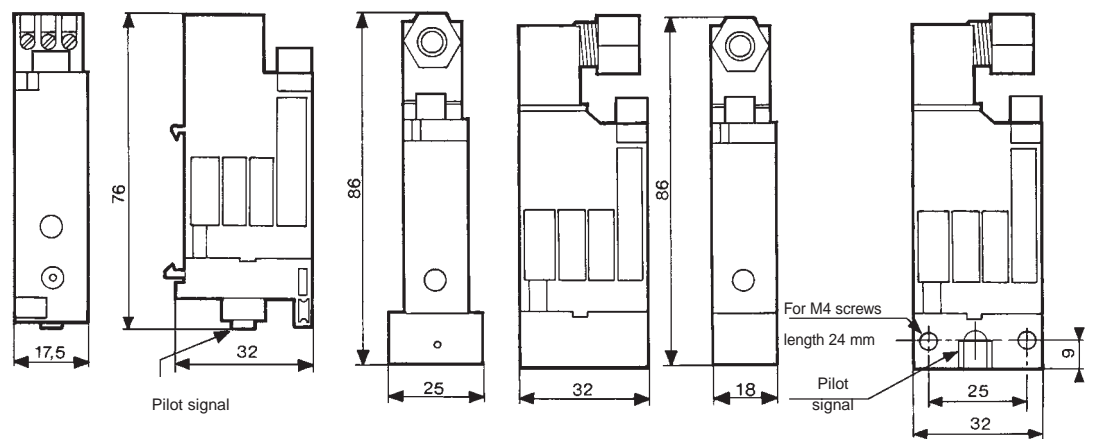

**81 509 080 - 81 509 085**

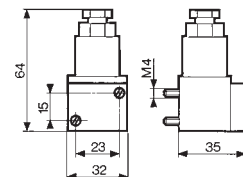

## Adjustable pressure switches (manostats) (pneumatic output)

› 100 % pneumatic



Also available in **ATEX** version for use in potentially explosive atmospheres in accordance with 94/9/EC Directive

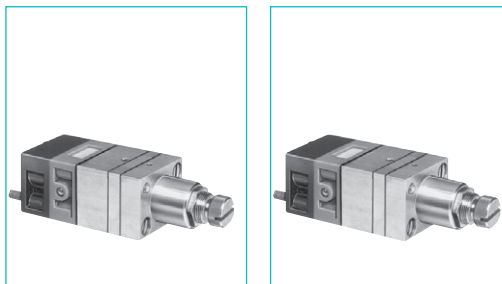

### Part numbers (and adjustment ranges)

Adjustment range	50 → 500 mb 0.1 → 2.5 b 2 → 8 b	<b>81 505 140</b> <b>81 505 150</b> <b>81 505 160</b>	<b>81 502 140</b> <b>81 502 150</b> <b>81 502 160</b>
Version		Positive output	Negative output
Accuracy	50 → 500 mb 0.1 → 2.5 b 2 → 8 b	10 % 4 % 4 %	10 % 4 % 4 %

### Symbol



### Characteristics

Orifice diameter	mm	2.5	2.5
Flow at 4 bars	NI/min	170	170
Hysteresis	50 → 500 mb	60 mb	60 mb
	0.1 → 2.5 b	100 mb	100 mb
	2 → 8 b	320 mb	320 mb
Connection - sub-base pages 54/55			
Operating temperature	°C	-5 → +50	-5 → +50
Mechanical life	operations	3 x 10 <sup>6</sup>	3 x 10 <sup>6</sup>
Weight	g	160	160

### Connections

Example of pressure threshold adjustment (mini-regulator - manostat)

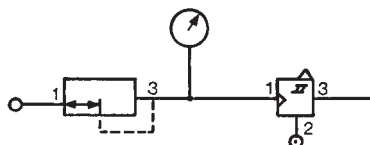

### Principle of operation

The manostats provide an on or off output signal when the input signal reaches a predetermined pressure threshold.

#### Positive output

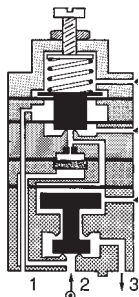
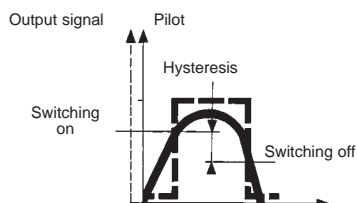

#### Negative output

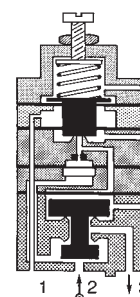
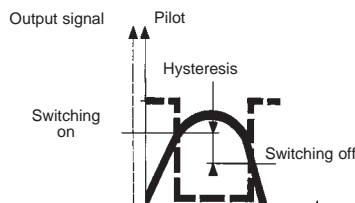

### Dimensions

81 502 140 - 81 502 150 - 81 502 160  
81 505 140 - 81 505 150 - 81 505 160

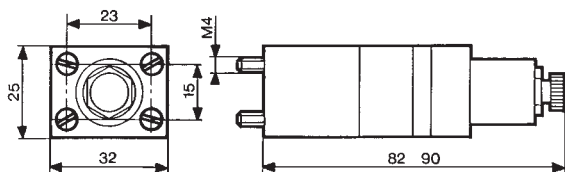

**Other information** Pressure switches with electrical output on request.

ATEX version products are available in the following catalogues: **Pneumatic products for explosive atmospheres** or on our website [www.crouzet-control.com](http://www.crouzet-control.com)

# Adjustable vacuum switches (vacuostat)

- › 100 % pneumatic
- › For vacuum -0,1 → -0,9 Bar

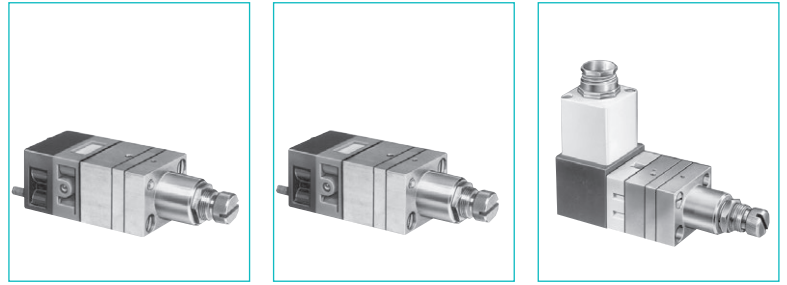

## Part numbers

81 505 110

Positive output

81 502 110

Negative output

81 508 110

Electrical output

## Symbol

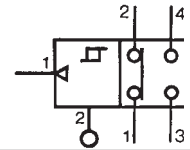
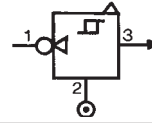
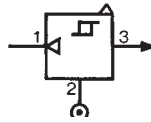

## Characteristics

Adjustment range	b	-0.1 → -0.9	-0.1 → -0.9	-0.1 → -0.9
Flow at 6 bars	Nl/min	170	170	170
Hysteresis	mb	80	80	80
Connection - sub-base pages 54/55		•	•	•
Operating temperature	°C	-5 → +50	-5 → +50	-5 → +50
Mechanical life	operations	3 x 10 <sup>6</sup>	3 x 10 <sup>6</sup>	3 x 10 <sup>6</sup>
Weight	g	160	160	180

## Connections

Example of use:  
Vacuum handling (vacuum generator, vacuum pad, vacuostats).

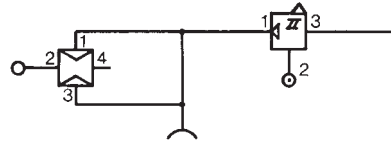

## Principle of operation

Vacuostats provide an on or off output signal when the input signal reaches a predetermined pressure threshold.

### Positive output

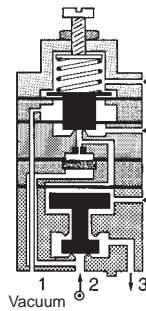
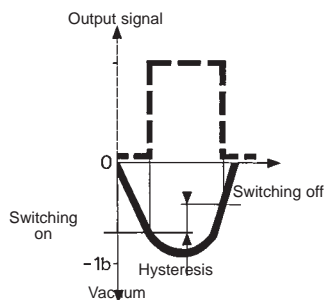

### Negative output

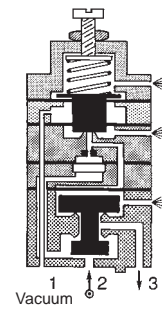
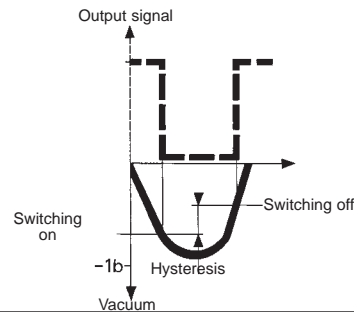

## Dimensions

81 502 110 - 81 505 110

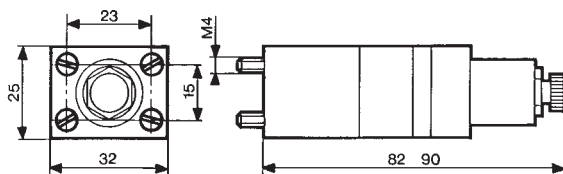

81 508 110

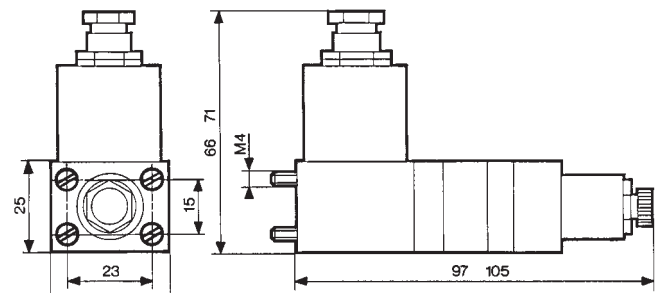

# Vacuum handling components

- › Sur le principe du Venturi
- › Facilement raccordable

 Also available in **ATEX** version for use in potentially explosive atmospheres in accordance with 94/9/EC Directive

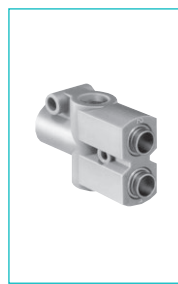
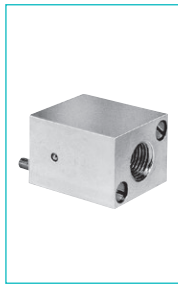

## Part numbers

Vacuum generators	<b>81 535 301</b> Sub-base mounting	<b>81 545 001</b> Plug-in	<b>81 545 005</b> Plug-in
-------------------	--	------------------------------	------------------------------

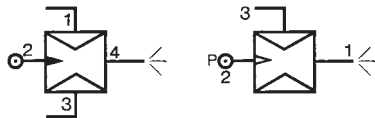

## Characteristics

Push-in connectors for semi-rigid tubing (NFE 49100)	Male/Female/Female (MFF) Female/Female/ Female (FFF)	—	Ø 4 mm	—
Operating pressure	bar	2 → 8	2 → 8	2 → 8
Vacuum pad material		—	—	—
Weight	g	80	13	25

Detection of the pressure decrease can be achieved by the use of manostats (see pages 38/39)

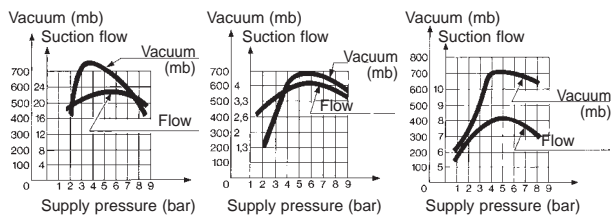

## Dimensions

### 81 535 301

Sub-base mounting 81 531... and 81 532...

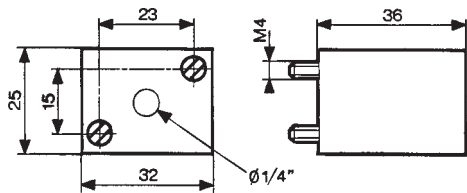

### 81 545 001

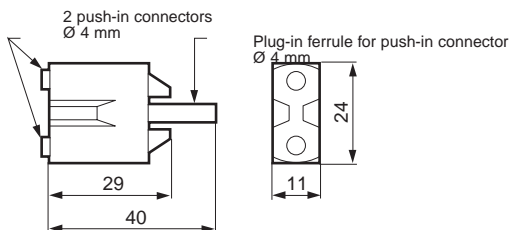

### 81 545 005

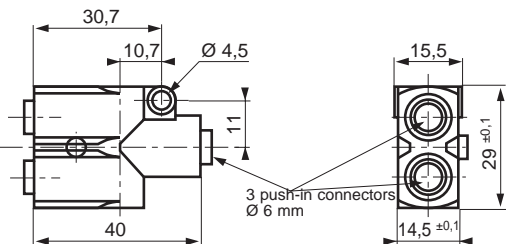



# **PNEUMATIC LOGIC COMPONENTS**

# General characteristics

## Operating fluid

- Compressed air or inert gas.

## Conditions of use

- Operating pressure 2 at 8 bars (except for special conditions).
- Fluid: Filtered air to 50 microns - non lubricated.
- Operating temperature from - 5° C to + 50° C (under + 5° C the dew point must be below 10° C for the application).
- For optimum performance, the elements should be inter-connected by air supply tubing with an internal diameter  $\geq$  at 2.5 mm.

## Mounting recommendations

- The elements should be mounted and piped in a clean atmosphere in order to prevent any form of pollution entering the system.
- Minimum torque for element fixing screws: 5 cm/kg.
- maximum torque for element fixing screws: 10 cm/kg.

## Characteristics common to all elements in the modular system

- The characteristics have been obtained with a supply pressure at 6 bars.
- The flow in NI/min is the number of litres of air at normal atmospheric pressure obtained with the output open to atmosphere and the supply pressure at 4 bars
- The consumption in NI/min is the number of litres of free air necessary for the unit to function.
- kV = the flow coefficient of the equipment.
- Mechanical life > 10<sup>7</sup> operations.

## flow graphs

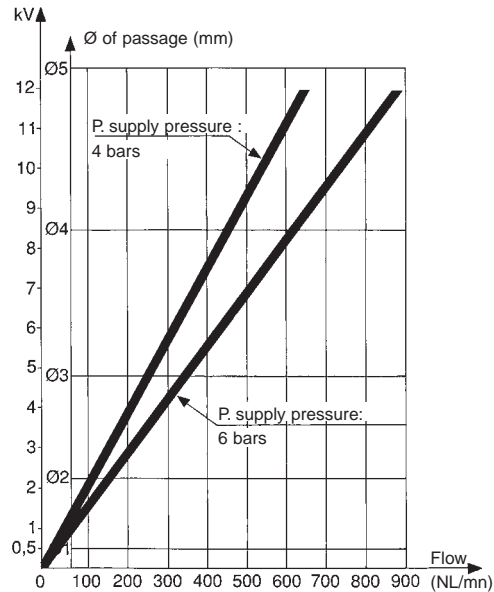

## Sequencer modules

Operation results from the combination of a sequential cycle. A system comprises individual modules which are joined together by means of a sub-base. Each module has a memory which delivers an output signal and receives an input signal.

An indicator on each module allows the operator to monitor the progress of the cycle and identify quickly and easily any fault which may occur.

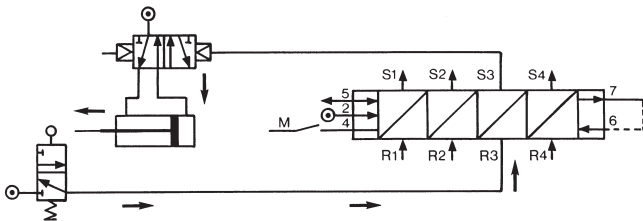

Operation results from the combination of three functions (memory, AND and OR) which constitute each module. The memory activates the output and gives priority to the reset signal. The AND element ensures the transition to the next module but only if an input signal is present. The OR element ensures the resetting of all previously operated modules

## Function diagram

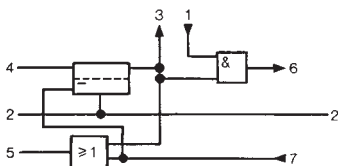

## sequencer module with maintained reset

### Brake

This maintains the memory spool in position only when the supply is lost.

## Module with auto reset

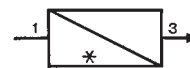
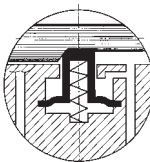

### Brake

This returns the memory spool to the reset condition only when the supply is lost

### Shift register

The general principle is to advance the sequencer step by command impulses to the inputs of the even steps, alternating with the command impulses to the inputs of the odd steps.

Used for example on a transfer machine to shift the information "bad component" collected at a test-test "n" steps further along the machine to a reject station.

## Function diagram

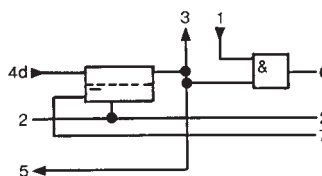

## Auto reset sequencer module

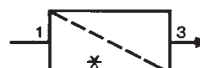
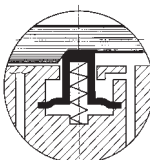

# Sequencer modules

- › 100 % pneumatic
- › Ideal for a simple pneumatic sequence

 Also available in **ATEX** version for use in potentially explosive atmospheres in accordance with 94/9/EC Directive

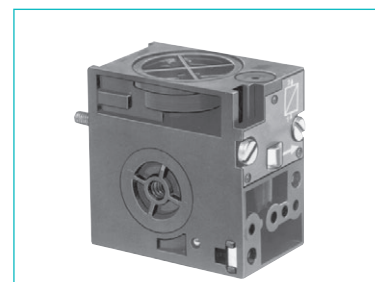
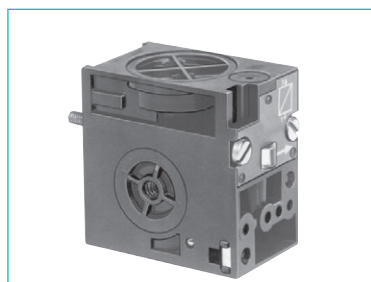

81 550 001	81 550 201	81 550 401	81 550 601
with 'maintain'	Reset to zero	—	—
—	—	with 'maintain'	Reset to zero

### Symbol



### Characteristics

Operating pressure	bar	2 → 8	2 → 8	2 → 8	2 → 8
Orifice diameter	mm	2.7	2.7	2.7	2.7
Flow at 6 bars	Nl/min	150	150	150	150
Operating temperature	°C	-5 → +50	-5 → +50	-5 → +50	-5 → +50
Mechanical life 5 x 10 <sup>6</sup> at 6 bars		•	•	•	•
Connection - Sub-base page 26		•	•	•	•
Weight	g	70	70	70	70

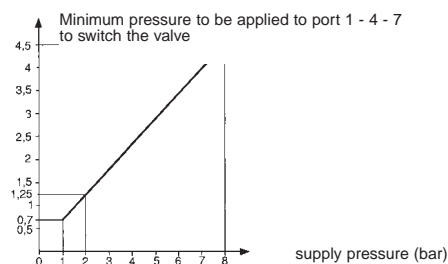

### Principle of operation

(supplied without logic element. For choice of units see pages 46/47)

#### Sequencer module with maintained reset

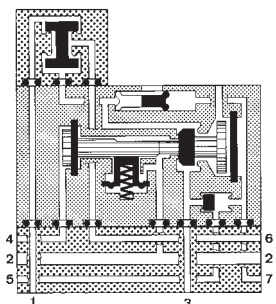

- 1 - Input signal
- 2 - Supply
- 3 - Output signal
- 4 - Start signal
- 5 - In cycle signal
- 6 - End of cycle signal
- 7 - Reset to zero signal

#### Shif register with maintained reset

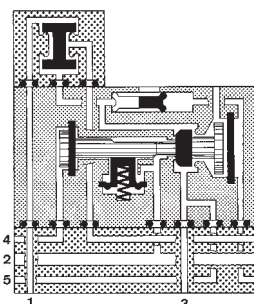

- 1 - Input signal
- 2 - Supply
- 3 - Output signal
- 4 - Start signal
- 5 - In cycle signal
- 6 - End of cycle signal
- 7 - Reset to zero signal

### Dimensions

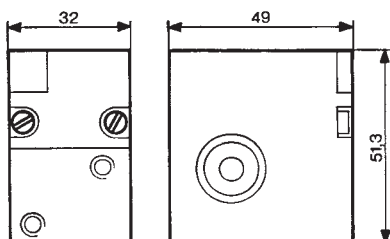

### Mounting plan for sequencer

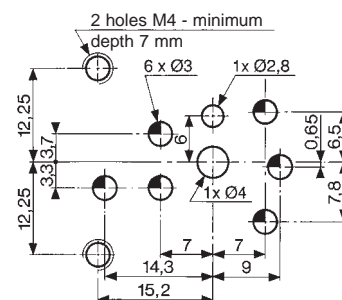

ATEX version products are available in the following catalogues: **Pneumatic products for explosive atmospheres** or on our website [www.crouzet-crouzet.com](http://www.crouzet-crouzet.com)

# Sequencer sub-bases



Also available in **ATEX** version for use in potentially explosive atmospheres in accordance with 94/9/EC Directive

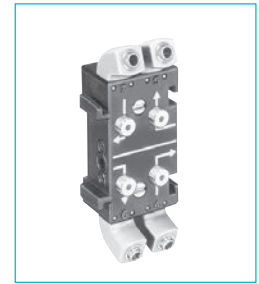
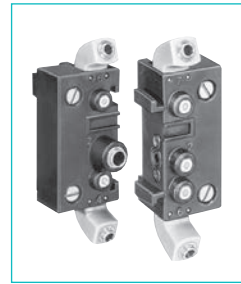
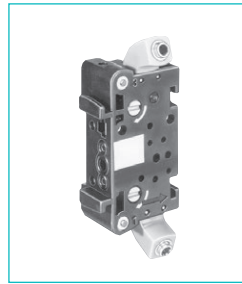

81 551 101  
Sub-base (DIN oméga)

81 552 101  
End bases - one pair

81 552 601  
Diversion base

Versions Front connecting (DIN-omega)  
Rear connecting (with clips)

### Characteristics

Sub-bases (fitted)	Rotatable connectors		•	•	•
	Pressure indicators		•	•	•
Operating temperature	°C	-5 → +50		-5 → +50	-5 → +50
Weight	g	55		135	60

### Sequencer connections

#### Front connecting

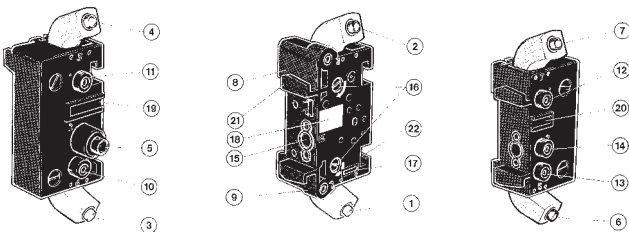
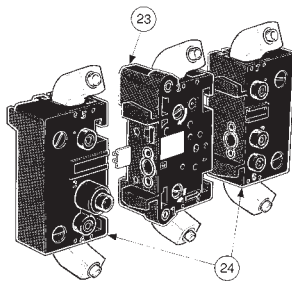

- 1 - Input port (green port 1) Ø 4
- 2 - Output port (red port 1) Ø 4
- 3 - Input port, cycle start (green port 1) Ø 4
- 4 - Output port, in-cycle signal (red port 1) Ø 4
- 5 - Output port, cycle end (red port 6) Ø 4
- 6 - Output port, cycle end (red port 6) Ø 4
- 7 - Input port, reset to zero (green port 7) Ø 4
- 8 - Output indicator (red)
- 9 - Input indicator (green)
- 10 - Cycle start indicator at port 4 (green)
- 11 - In-cycle indicator at port 5 (red)
- 12 - Input indicator at port 7 (green)
- 13 - End of cycle indicator at port 6 (red)
- 14 - Supply indicator at port 2 (yellow)
- 15 - Interconnecting ports
- 16 - Fixing screws
- 17 - Engraved arrow to indicate direction of sequence
- 18 - Marking tag
- 19 - Marking tag position
- 20 - Marking tag position
- 21 - Mounting tongue
- 22 - Mounting groove
- 23 - Sub-base
- 24 - End bases

### Dimensions

#### Front connecting

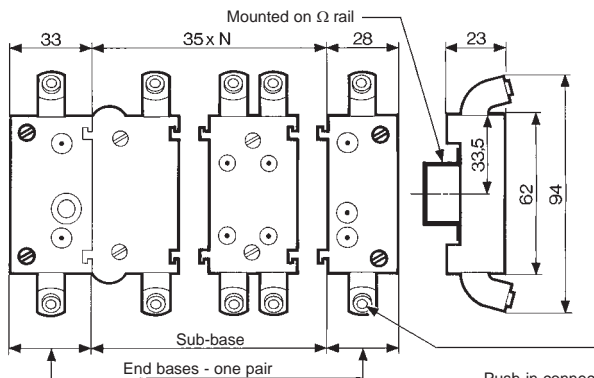

Push-in connection for semi-rigid tube  
Ø 4 mm (NFE 49100)

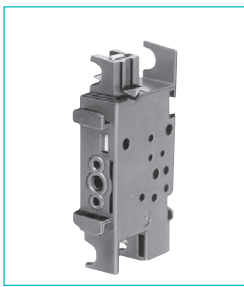

81 551 001

81 552 001

Sub-base (with clips)

End bases - one pair

-5 → +50  
40

-5 → +50  
120

Rear connecting

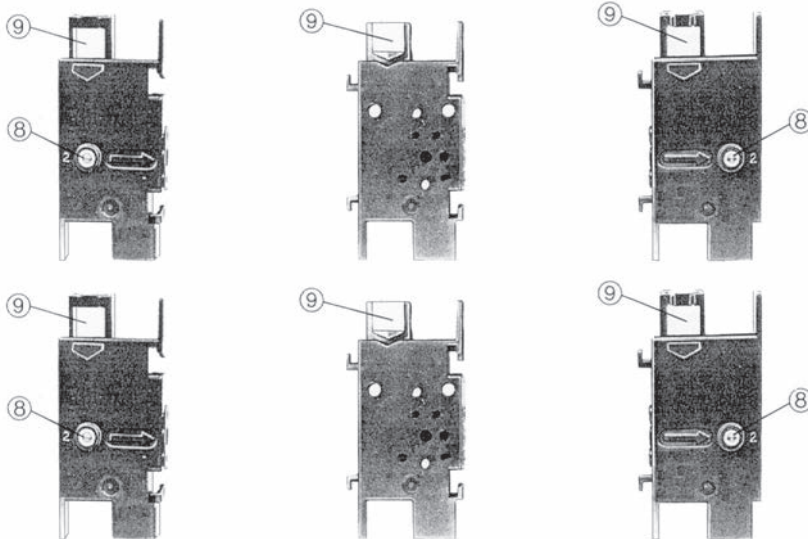

- 1 - Input port (marked port 1)
- 2 - Supply port (Port 2)
- 3 - Output port (Port 3)
- 4 - Cycle start signal port (Port 4)
- 5 - In-cycle signal port (Port 5)
- 6 - End of cycle signal port (Port 6)
- 7 - Reset to zero signal port (Port 7)
- 8 - Indicator at supply port
- 9 - Marking area

Rear connecting

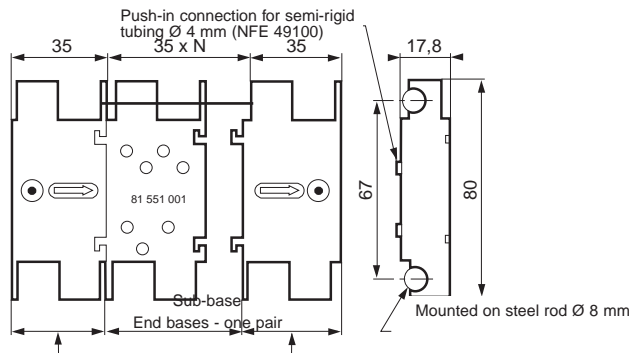

# Logic elements

- › Performs "combined" Pneumatic
- › Easy to use

 Also available in **ATEX** version for use in potentially explosive atmospheres in accordance with 94/9/EC Directive

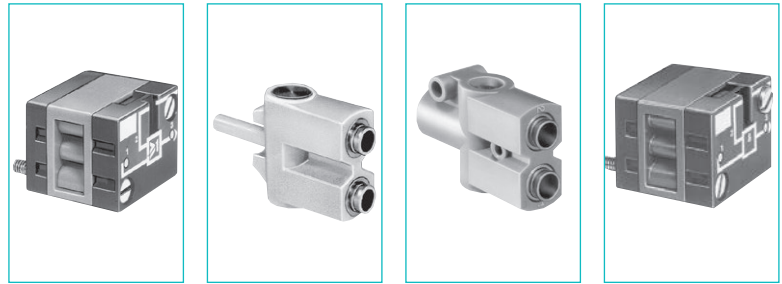

Functions	OR	81 521 501	81 540 001	81 540 005	81 522 501
	AND	—	—	—	—
	YES	—	—	—	—
	NO	—	—	—	—
Version		On Sub-base page 4/14-4/15	Plug-in Ø 4	Plug-in Ø 6	On Sub-base page 4/14-4/15

## Symbol

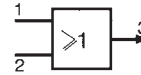

## Characteristics

Push-in connection for semi-rigid tubing (NFE 49100)	Male/Female/Female	—	Ø 4 mm	—	—
	Female/Female/Female	—	—	Ø 6 mm	—
Colour		Blue	Blue	Blue	Green
Operating pressure	bar	2 → 8	2 → 8	2 → 8	2 → 8
Orifice diameter	mm	2.7	2.7	4	2.7
Flow at 6 bars	NI/min	170	170	200	170
Pressure indicator		•	—	—	•
Switching time	ms	—	—	—	—
Operating temperature	°C	-5 → +50	-5 → +50	-5 → +50	-5 → +50
Mechanical life	operations	>10 <sup>7</sup>	>10 <sup>7</sup>	>10 <sup>7</sup>	>10 <sup>7</sup>
Weight	g	25	12	25	25

## Pilot/pressure curves

P<sub>p</sub> : Pilot pressure  
P<sub>a</sub> : Supply pressure

## Principle of operation

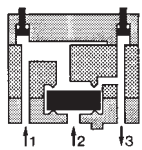

### Cellule OR

The output signal "S" is present when a signal at "a" OR "b" is present:

$$S = a \text{ OR } b$$

$$S = a + b$$

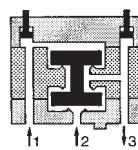

### Cellule AND

The output signal "S" is present only when signals "a" AND "b" are present simultaneously:

$$S = a \text{ AND } b$$

$$S = a \cdot b$$

## Dimensions

81 521 501 - 81 522 501

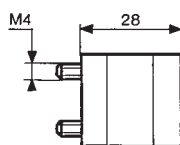
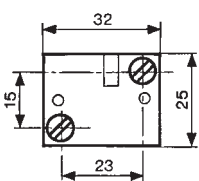

81 540 005 - 81 541 005

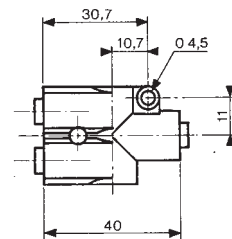

81 540 001 - 81 541 001

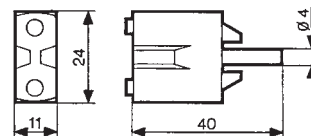
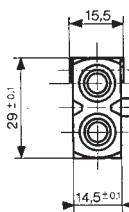

## Other information

See pages 54/55 for mounting plan for logic elements.

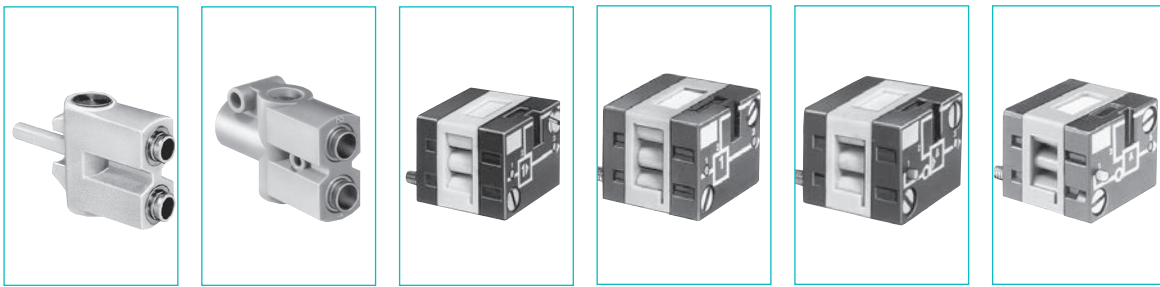

81 541 001	81 541 005	81 501 025	81 503 025	81 504 025	81 506 025
Plug-in Ø 4	Plug-in Ø 6	On sub-base page 36-37	Threshold On sub-base page 4/14-4/15	Threshold On sub-base page 4/14-4/15	Threshold On sub-base page 4/14-4/15

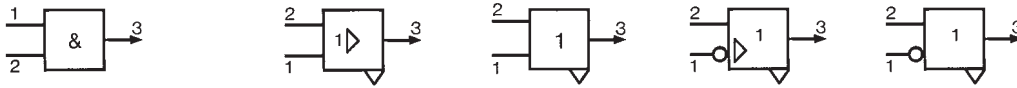

Ø 4 mm	Ø 6 mm				
Green	Green	Yellow	Orange	Light grey	Dark grey
2 → 8	2 → 8	2 → 8	2 → 8	2 → 8	2 → 8
2.7	4	2.7	2.7	2.7	2.7
150	200	170	170	170	170
	•	•	•	•	•
-5 → +50	-5 → +50	< 4	< 4	< 4	< 4
>10 <sup>7</sup>	>10 <sup>7</sup>	-5 → +50	-5 → +50	-5 → +50	-5 → +50
13	25	>10 <sup>7</sup>	>10 <sup>7</sup>	>10 <sup>7</sup>	>10 <sup>7</sup>
		30	30	30	30

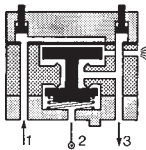
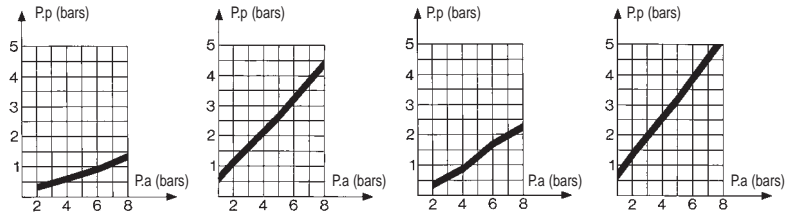

**YES element**

The output signal "S" is only present when the pilot is present "a" is present:

$S = a$  YES b

$S = a$

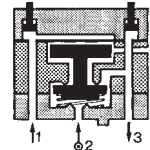

**NOT element**

The output signal "s" is present only if the input signal "a" is NOT present. The output signal is therefore the inverse of the pilot signal:

$S = \overline{a}$  NOT a

$S = \overline{a}$

If the supply port is connected to a 2nd input "b", the function obtained is called inhibition:

$S = \overline{a} \cdot b$

$S = \overline{a} \cdot b$

81 501 025 - 81 503 025  
81 504 025 - 81 506 025

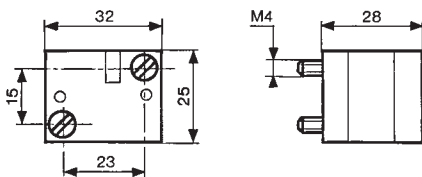

# Memory element

- › 100 % pneumatic
- › Bistable pneumatic

 Also available in **ATEX** version for use in potentially explosive atmospheres in accordance with 94/9/EC Directive

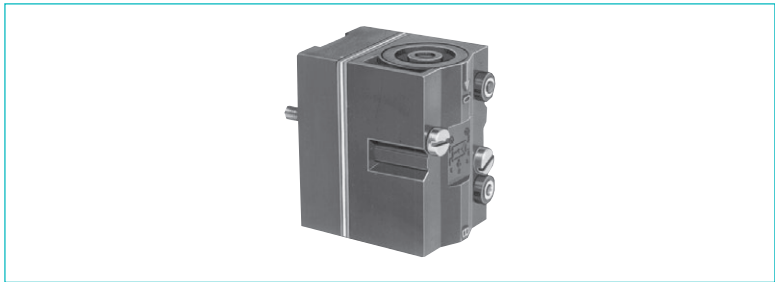

Version

**81 523 201**  
With pressure indicator

**81 523 601**  
With pressure indicator and manual override

## Symbol

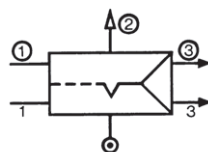

## Characteristics

Colour		Black	Black
Operating pressure	bar	2 → 8	2 → 8
Orifice diameter	mm	2.7	2.7
Minimum memory pilot pressure	bar	2.5	2.5
Operating temperature	°C	-5 → +50	-5 → +50
Flow at 6 bars	NI/min	200	200
Connection - On sub-base page	4/14-4/15	●	●
Weight	g	90	90

## Principle of operation

The function is that of a 4/2 valves. The appearance of signal "X1" causes the displacement of the slide valve. The output port "x" is then put under pressure. This state is remembered until the arrival of signal "X0". This signal reverses the slide valve, the output "x" is put under pressure. This state is likewise remembered. The output:

- "x" under pressure indicates that the information in the MEMORY is "X1",
- "x" under pressure indicates that the information in the MEMORY is "X0".

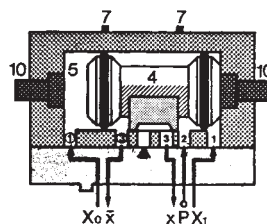

## Dimensions

81 523 201 - 81 523 601

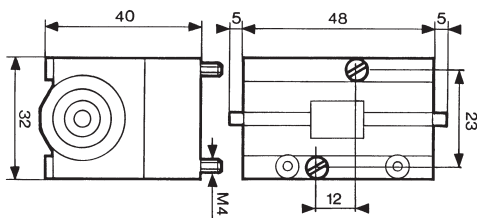

## Dimensions of logic and memory elements

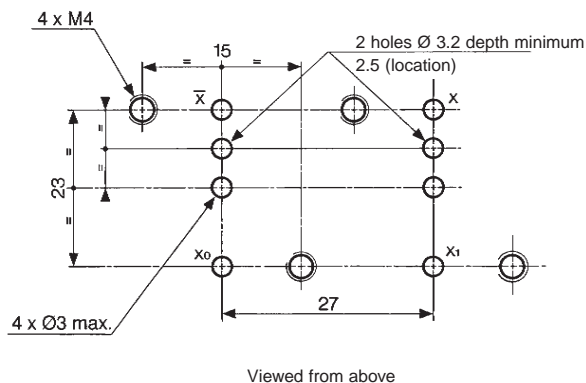

ATEX version products are available in the following catalogues: **Pneumatic products for explosive atmospheres** or on our website [www.crouzet-control.com](http://www.crouzet-control.com)



# Timers fixed timing

## › Fixed 0.4 s



Also available in **ATEX** version for use in potentially explosive atmospheres in accordance with 94/9/EC Directive

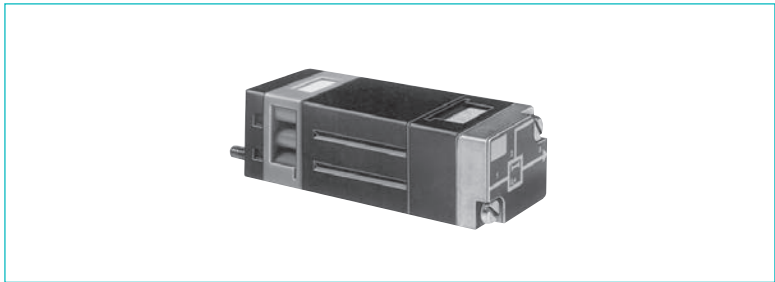

81 503 540  
Positive output

Version

### Symbol

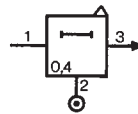

### Characteristics

Timing	s	0.4
Operating pressure	bar	2 → 8
Flow at 6 bars	NI/min	170
Orifice diameter	mm	2.7
Accuracy	%	± 5
Min. reset time	s	<0.1
Connection - On sub-base page 36-37		●
Operating temperature	°C	-5 → +50
Mechanical life	operations	>10 <sup>7</sup>
Weight	g	106

### Principle of operation with positive output

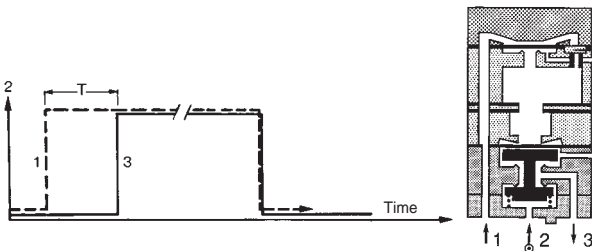

### Dimensions

81 503 540

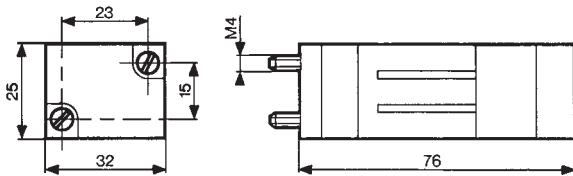

ATEX version products are available in the following catalogues: **Pneumatic products for explosive atmospheres** or on our website [www.crouzet-crouzet.com](http://www.crouzet-crouzet.com)

# Timers (with adjustable timing)

› 60 s adjustable (60 s max.)



Also available in **ATEX** version for use in potentially explosive atmospheres in accordance with 94/9/EC Directive

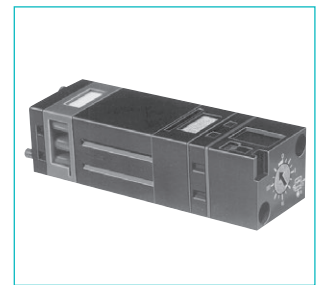
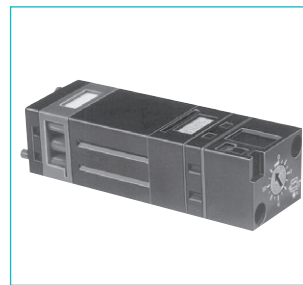

81 503 710

81 506 710

81 503 720

81 506 720

81 503 725

81 506 725

Function	positive
	negative

●	—	●	—	●	—	●	—
—	●	—	●	—	●	—	●

### Symbol

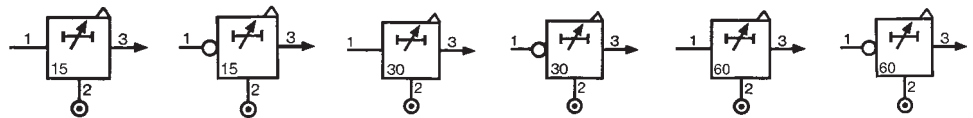

### Characteristics

Timing	s	0.1 → 15	0.1 → 15	0.1 → 30	0.1 → 30	0.1 → 60	0.1 → 60
Operating pressure	bar	2 → 8	2 → 8	2 → 8	2 → 8	2 → 8	2 → 8
Flow at 6 bars	NI/min	170	170	170	170	170	170
Orifice diameter	mm	2.7	2.7	2.7	2.7	2.7	2.7
Accuracy	%	± 5	± 5	± 5	± 5	± 5	± 5
Min. reset time	s	<0.1	<0.1	<0.1	<0.1	<0.1	<0.1
Connection - On sub-base page 4/14-4/15		●	●	●	●	●	●
Operating temperature	°C	-5 → +50	-5 → +50	-5 → +50	-5 → +50	-5 → +50	-5 → +50
Mechanical life	operations	>10 <sup>7</sup>	>10 <sup>7</sup>	>10 <sup>7</sup>	>10 <sup>7</sup>	>10 <sup>7</sup>	>10 <sup>7</sup>
Weight	g	90	90	100	100	120	120

### Accessories

Panel mounting adaptor		79 451 698	79 451 698	79 451 903	79 451 903	—	—
Weight	g	53	53	53	53	—	—

### Principle

The operation of these pneumatic timers is similar to that of electronic timers (circuit with capacitor/resistor)

### Principle of operation

with positive output

with negative output

### Timing by charging of reservoir

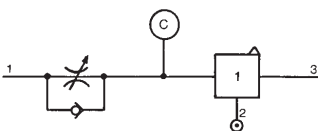

The reservoir fills via the flow restrictor until the switching point of the timer output is reached (positive or negative). The non-return valve allows the reservoir to be emptied rapidly for the next timing.

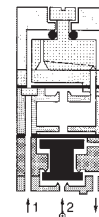
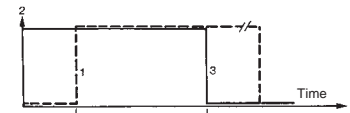
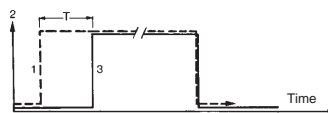

### Dimensions

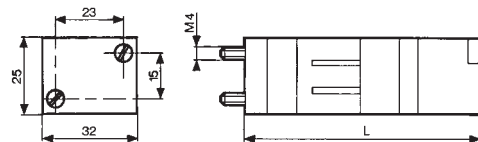

	L (mm)
81 503 710 - 81 506 710	78
81 503 720 - 81 506 720	92
81 503 725 - 81 506 725	125

### Adaptor 79 451 ...

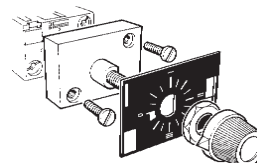
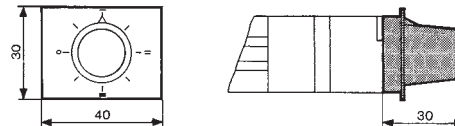

For panel mounting, a pre-drilled hole Ø 10.5 mm is required

ATEX version products are available in the following catalogues: **Pneumatic products for explosive atmospheres** or on our website [www.crouzet-control.com](http://www.crouzet-control.com)

# Timers

## › Fixed and adjustable



Also available in **ATEX** version for use in potentially explosive atmospheres in accordance with 94/9/EC Directive

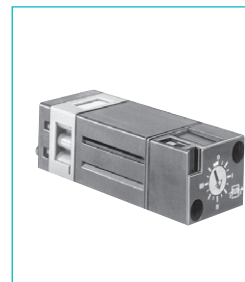

Single impulse generator	Fixed	81 507 540	—	—
	Adjustable	—	81 507 720	—
Adjustable frequency generator	—	—	—	81 506 940

## Symbol



## Characteristics

Timing	s	0.4	0.1 → 30	—
Frequency	Hz	—	—	0.02 → 8
Operating pressure	bar	2 → 8	2 → 8	2 → 8
Flow at 6 bars	Nl/min	170	170	170
Orifice diameter	mm	2.7	2.7	2.7
Accuracy	%	± 5	± 5	± 5
Min. reset time	s	<0.1	<0.1	<0.1
Connection - On sub-base page 4/14-4/15		●	●	●
Operating temperature	°C	-5 → +50	-5 → +50	-5 → +50
Mechanical life	operations	>10 <sup>7</sup>	>10 <sup>7</sup>	>10 <sup>7</sup>
Weight	g	106	180	85

## Accessories

Panel mounting adaptators	—	79 451 904	79 451 905
Weight (g)	—	53	53

## Principle of operation

Single impulse generator

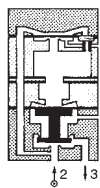
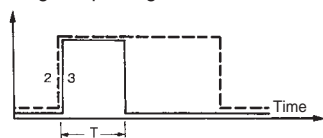

Adjustable impulse generator

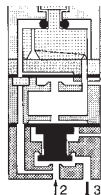

Frequency generator

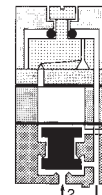
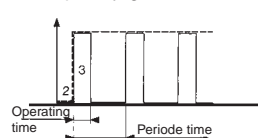

## Dimensions

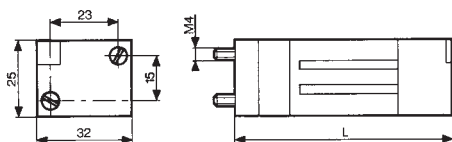

79 451

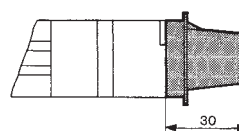
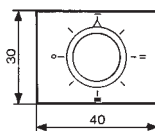

Part numbers	L (mm)
81 507 540	73
81 507 720	99
81 506 940	72

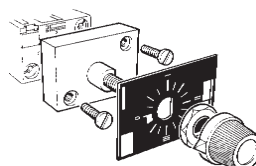

For panel mounting, a pre-drilled hole Ø 10.5 mm si required

# Timing Accessories



Also available in **ATEX** version for use in potentially explosive atmospheres in accordance with 94/9/EC Directive

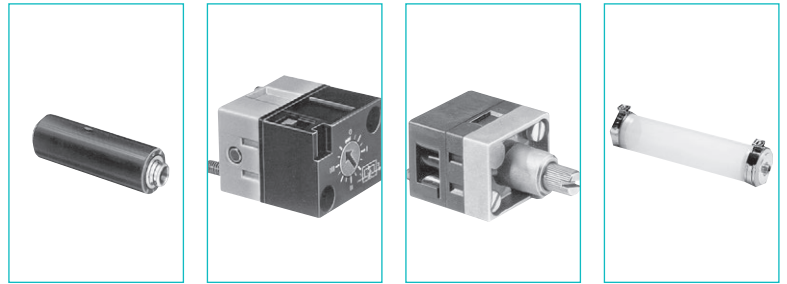

One-way in-line fixed flow restrictors	Flow at 4 bars Nm <sup>3</sup> /h	Ø orifice (mm)				
	0.18 → 0.30	0.3	white	81 529 003	—	—
	0.35 → 0.50	0.4	yellow	81 529 004	—	—
	0.58 → 0.77	0.5	red	81 529 005	—	—
	0.80 → 1.06	0.6	green	81 529 006	—	—
	1.10 → 1.39	0.7	blue	81 529 007	—	—
	1.45 → 1.65	0.8	grey	81 529 008	—	—
	2.30 → 2.80	1	black	81 529 010	—	—
	0.08 → 0.12	0.25	white	81 529 025	—	—
One-way adjustable flow restrictor					81 525 101	81 526 001
Capacity for timing	10 • 60 s				—	—
						79 458 808

## Symbol

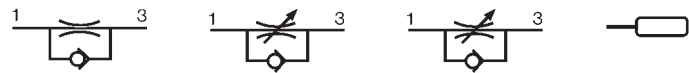

## Characteristics

Free flow	Nl/min	Depending on orifice	30	200	—
Orifice diameter	mm	Depending on orifice	0 → 0.5	0 → 1.7	—
Operating pressure	bars	1 → 8	1 → 8	2 → 8	—
Timing	s	—	—	—	10 → 60
Capacity	cm <sup>3</sup>	—	—	—	30
Connection	Sub-base page 4/14-4/15 Push-in connection for semi-rigid tubing (NFE 49100)	mm	Ø 4	—	Ø 4
Operating temperature	°C	-5 → +50	-5 → +50	-5 → +50	-5 → +50
Weight	g	8	60	70	40

## Connections

- For timing circuit
- One-way flow restrictor 81 525 1 - 81 529 0 (1)
- Reservoir 79 458 018 (2)
- Relay element 81 503 0 - 81 506 0 (3) page 4/6-4/7
- Sub-base page 4/14-4/15

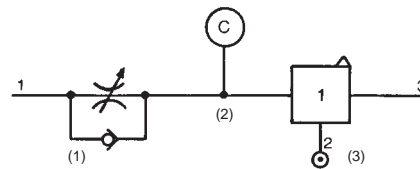

## Principle of operation

One-way with fixed flow

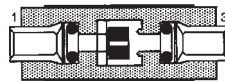

One-way with adjustable flow

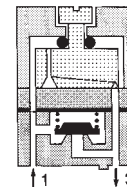

## Dimensions

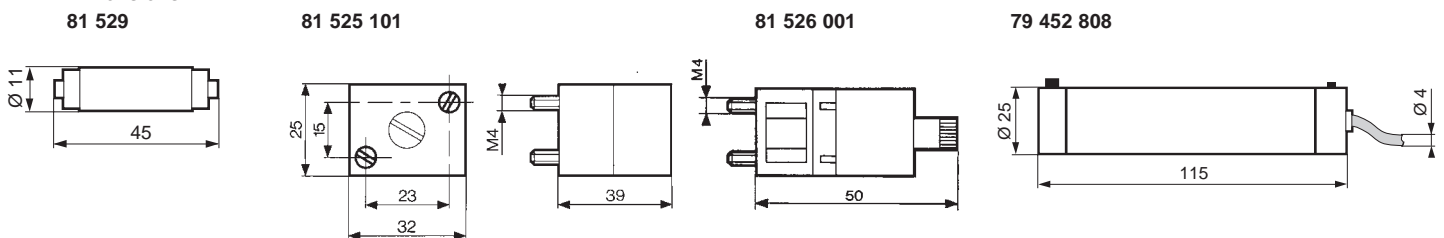

ATEX version products are available in the following catalogues: **Pneumatic products for explosive atmospheres** or on our website [www.crouzet-control.com](http://www.crouzet-control.com)

## Regulator accessories



Also available in **ATEX** version for use in potentially explosive atmospheres in accordance with 94/9/EC Directive

### Part numbers

Mini-détenteur	81 527 001	—
Plug element	—	—
In-line non-return	—	81 529 901

### Symbol

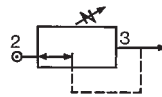

### Characteristics

Operating pressure	bars	2 → 8	2 → 8
Flow at 6 bars	NI/min	200	200
Adjustable output pressure	bar	0,1 → 8	—
Connection	Sub-base	•	—
	Push-in connection for semi-rigid tubing (NFE 49100)	mm	Ø 4
Weight	g	150	70

### Dimensions

81 529 901

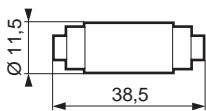

# Sub-bases for logic elements

 Also available in **ATEX** version for use in potentially explosive atmospheres in accordance with 94/9/EC Directive

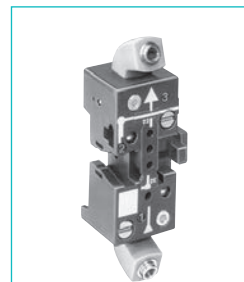
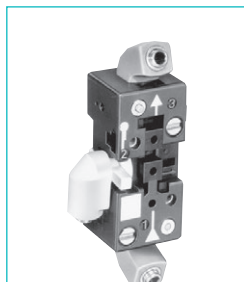

	81 532 104	81 532 102
Two-hand start module	● 1	● 1
Manostats - vacuostats	● 1	● 1
Leak sensor and amplifier relays	● 1	● 1
Logic elements AND Timers	● 1	● 1
Regulator accessories	● 1	● 1
Memory element	—	—
Operating temperature °C	-5 → +50	-5 → +50
Electro-pneumatic miniature solenoid	● 1	● 1

**NB:** The number indicates the number of components mounted on the sub-base ↑

## Characteristics

Push-in connection for semi-rigid tubing Ø 4 mm (NFE 49100)	rotatable	rotatable
Fixation	DIN rail 35 mm	DIN rail 35 mm
Weight	g 56	52

## Connections elements and relays

### Front connecting

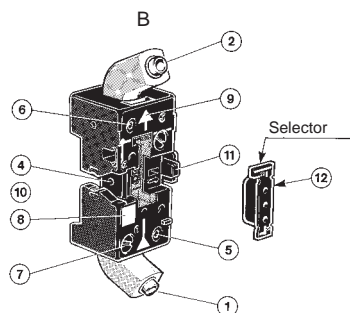
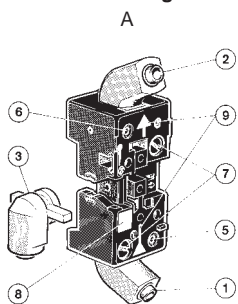

- A - Single sub-base or end base
- B - Associable sub-base
- 1 - Input port (green port 1)
- 2 - Output port (red port 3)
- 3 - Input/supply port (yellow port 2) Ø 4
- 4 - Input port integral to sub-base
- 5 - Input indicator (green)
- 6 - Output indicator (red)
- 7 - 1/4 turn screws
- 8 - Marking tag
- 9 - Arrow indicating flow direction
- 10 - Mounting tongue
- 11 - Mounting groove
- 12 - Selector

## Dimensions

 81 532 104

 3 x 81532102

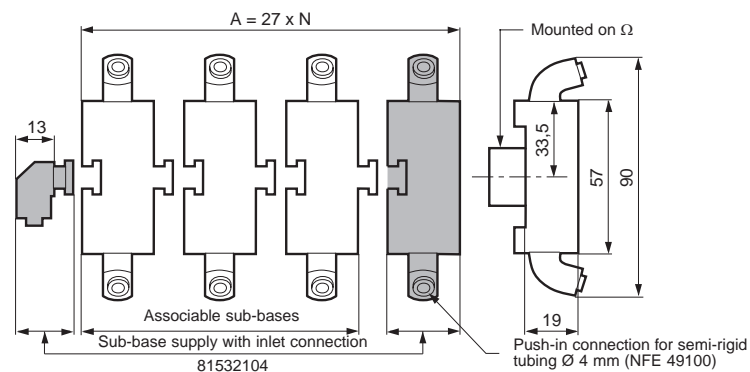

**ATEX** version products are available in the following catalogues: **Pneumatic products for explosive atmospheres** or on our website [www.crouzet-control.com](http://www.crouzet-control.com)

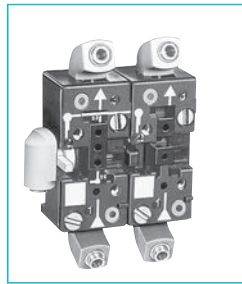

81 542 002

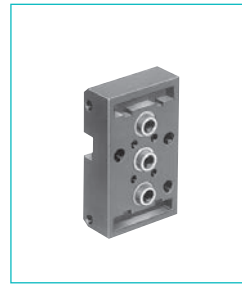

81 532 001

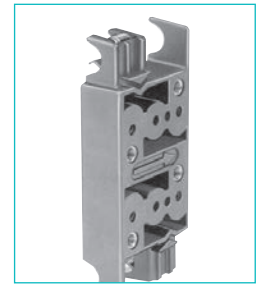

81 531 001

Two-hand start module	—	● 1	● 2
Manostats - vacuostats	—	● 1	● 2
Leak sensor and amplifier relays	—	● 1	● 2
Logic elements AND Timers	—	● 1	● 2
Regulator accessories	—	● 1	● 2
Memory element	● 1	—	● 1
Operating temperature °C	-5 → +50	-5 → +50	-5 → +50
Electro-pneumatic miniature solenoid	—	● 1	● 2

**Caractéristiques**

Push-in connection for semi-rigid tubing Ø 4 mm (NFE 49100)	rotatable	rear	rear
Fixation	DIN rail 35 mm	2 M4 screws	Clips for rails Ø 8 mm
Weight	g	95	10
			35

**Memory element sub-base, front and rear connecting**

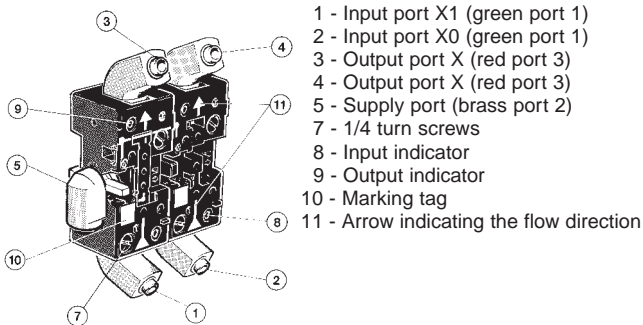

**Rear connection**

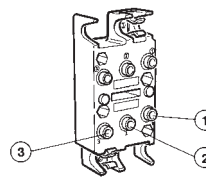

The modular system elements are fixed with two screws on the sub-base. A locating device on each logic element prevents incorrect assembly. The logic element is connected via the sub-base. This sub-base has 3 instant connections for connecting semi-rigid tubes with outer Ø 4.

- 1 - Input signal
- 2 - Signal port for passive logic elements, air supply for active logic elements.
- 3 - Output signal

81 542 002 (for memory 81523201/601)

81 531 001

81 532 001

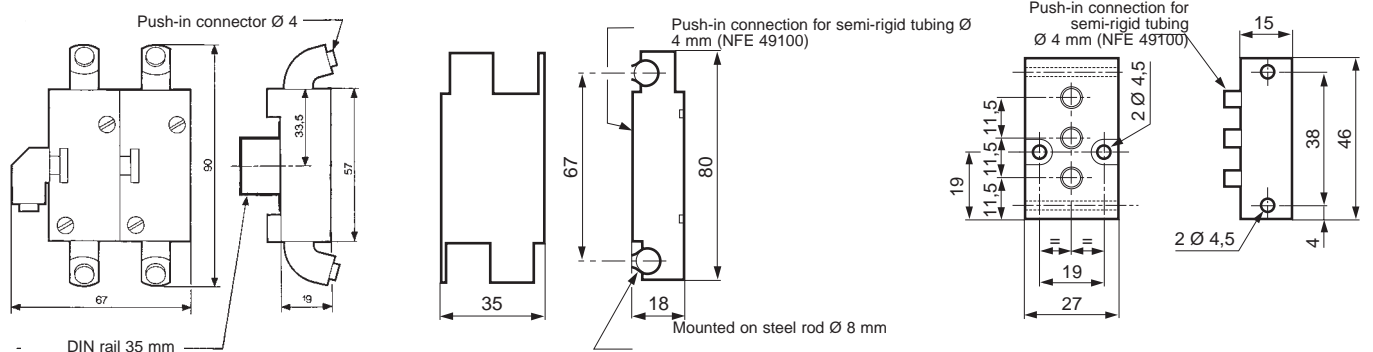

## Mounting accessories



Also available in **ATEX** version for use in potentially explosive atmospheres in accordance with 94/9/EC Directive

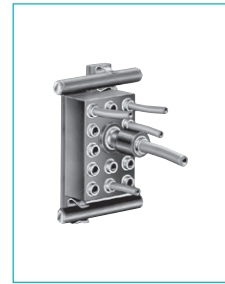
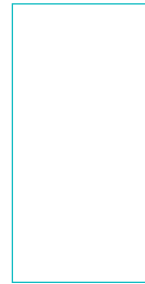
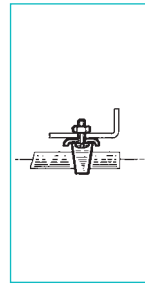
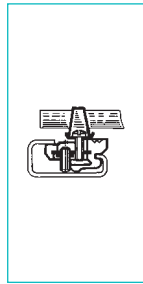
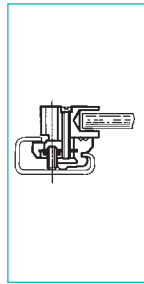

Mounting equipment

81 533 501  
Hole domino

81 533 001  
Clip domino

79 450 609  
Bar clips  
Ø 8

—

Supply manifold 13 outputs

—

—

—

81 536 801

### Characteristics

Weight (g)	8 For mounting on the end of a zinc-coated mild steel rod Ø 8 mm on an asymmetrical DIN rail	4 For adjustable mounting on a zinc-coated mild steel rod Ø 8 mm on an asymmetrical DIN rail	80 Packet of 100 pieces	80
Operating temperature °C	-5 → +50	-5 → +50	-5 → +50	-5 → +50

### Dimensions

81 536 804

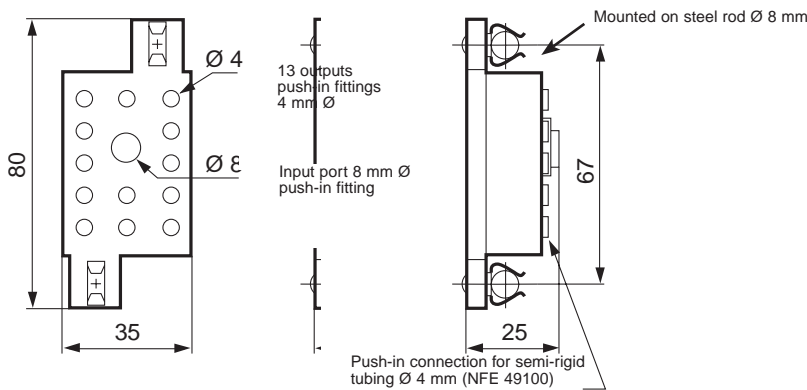

### Other information

Use Weidmuller plastic labels for marking components part number FW 4734-6.

ATEX version products are available in the following catalogues: **Pneumatic products for explosive atmospheres** or on our website [www.crouzet-control.com](http://www.crouzet-control.com)



# **ELECTRO-PNEUMATIC CONTROL VALVES**

# Miniature solenoid valves for alternating current

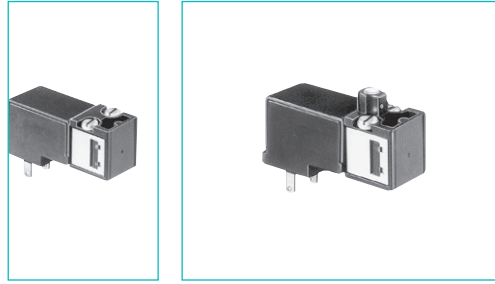

- › Conform to the Low Voltage Directive
- › For mounting on sub-base or footprint in accordance with CNOMO recommendation E-06-36-120N

Part numbers (and voltages)				
Consumption	Voltage	81 519 080	81 519 380	81 519 680
2.5 VA	24 V ~ 50-60 Hz	—	81 519 381	—
2.5 VA	48 V ~ 50-60 Hz*	—	81 519 378	81 519 678
2.5 VA	110 V ~ 50-60 Hz	—	81 519 379	81 519 679
2.5 VA	220 V- 230 V ~ 50-60 Hz	—	—	—
Function		3/2 NC	3/2 NC	3/2 NC
Version		Without manual override	With manual override by impulse	With manual override by latching (1/4 turn)

Characteristics				
Operating pressure	bar	1 → 8	1 → 8	1 → 8
Orifice diameter	mm	0.5	0.5	0.5
Flow at 6 bars	NI/min	12	12	12
kV		0.12	0.12	0.12
Switching time	ms	5 → 15	5 → 15	5 → 15
Mechanical life (operations)		5 · 10 <sup>7</sup>	5 · 10 <sup>7</sup>	5 · 10 <sup>7</sup>
Operating temperature	°C	-10 → +50	-10 → +50	-10 → +50
Compressed air or inert gas - oil-free air filtered to 50 µ		●	●	●
Duty factor		100 % ED	100 % ED	100 % ED
Insulation class	IEC 85	F	F	F
Weight		35	35	35
Rotatable connector 4 positions in 90° steps		●	●	●
Degree of protection with sub-base (page 62)	IEC 529	IP 20	IP 20	IP 20
with connector 81 516 082 (page 65)	IEC 529	IP 65	IP 65	IP 65
UL and cUL approval		MH 15085	MH 15085	MH 15085

**15x15 mm footprint**  
according to CNOMO E 06-36-120N

**Dimensions**  
**81 519 0** **81 519 3** **81 519 6**

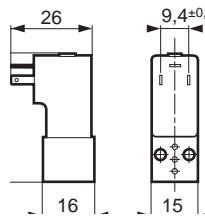
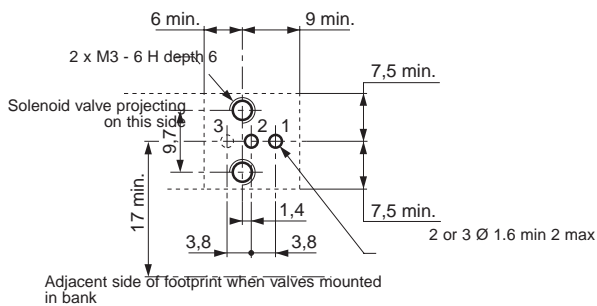

Manual override

- 1 - Supply
- 2 - Output
- 3 - Exhaust

# Miniature solenoid valves for direct current

- › Conform to the Low Voltage Directive
- › For mounting on sub-base or footprint in accordance with CNOMO recommendation E-06-36-120N

 Also available in ATEX version for use in potentially explosive atmospheres in accordance with 94/9/EC Directive

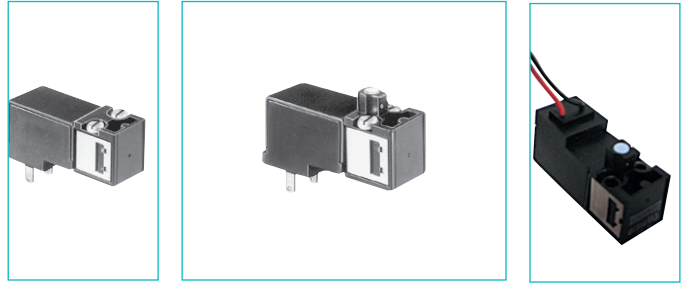

## Part numbers (and voltages)

	Consumption	Voltage	81 519 032	81 519 332	81 519 632	81 519 340
Function	1 W	24 V $\overline{\text{DC}}$	3/2 NC	3/2 NC	3/2 NC	3/2 NF
Version			Without manual override	With manual override by impulse	With maintained manual override	With maintained manual override

## Characteristics

Operating pressure	bar	1 → 8	1 → 8	1 → 8	1 → 8
Orifice diameter	mm	0.8	0.8	0.8	0,8
Flow at 6 bars	NI/min	25	25	25	25
kV		0.3	0.3	0.3	0,3
Switching time	ms	5 → 15	5 → 15	5 → 15	5 → 15
Mechanical life (operations)		5 10 <sup>7</sup>	5 10 <sup>7</sup>	5 10 <sup>7</sup>	5 10 <sup>7</sup>
Operating temperature	°C	-10 → +50	-10 → +50	-10 → +50	-10 → +50
Compressed air or inert gas - oil-free air filtered to 50 µ		•	•	•	•
Duty factor		100 % ED	100 % ED	100 % ED	100 % ED
Insulation class	IEC 85	F	F	F	F
Weight		35	35	35	35
Rotatable connector 4 positions in 90° steps		•	•	•	•
Degree of protection with M12 5-pin connector	IEC 529	—	—	—	—
Degree of protection with connector 81 516 082	IEC 529	IP 65	IP 65	IP 65	IP 65
UL and cUL approval		MH 15085	MH 15085	MH 15085	MH 15085

## 15x15 mm footprint

according to CNOMO E 06-36-120N

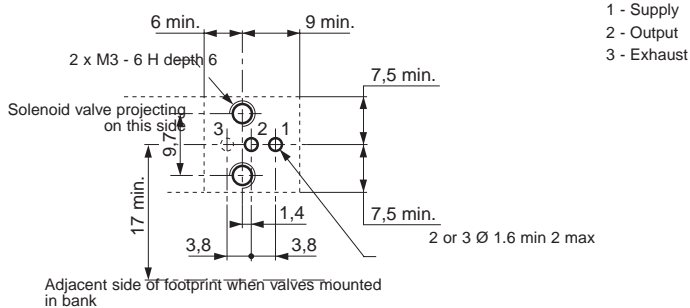

## Encombrement

81 519 0

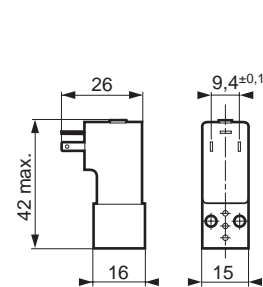

81 519 3  
81 519 6

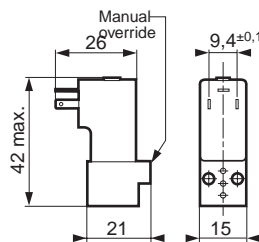

81 519 3

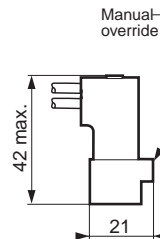

ATEX version products are available in the following catalogues: **Pneumatic products for explosive atmospheres** or on our website [www.crouzet-control.com](http://www.crouzet-control.com)



# Electro-pneumatic miniature control valves

## Mounting

### Miniature solenoid valves

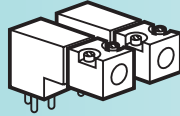

### Indicators

- LED seals
- LED

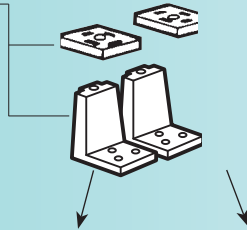

### Valve modules

- Poppet
  - 3/2 monostable (17.5 mm)
  - 4/2 monostable (17.5 mm)
- Slide valve
  - 4/2 bistable (35 mm)
  - 4/2 monostable spring-return (35 mm)

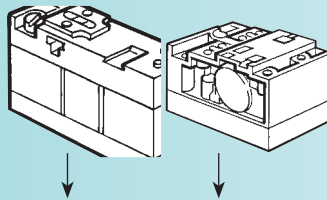

### Sub-bases

For miniature solenoid valves

For valve modules

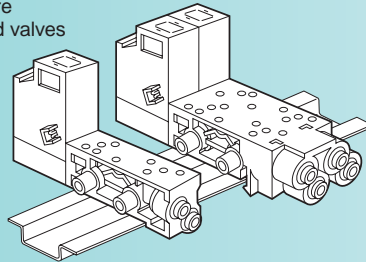

Single

Double

### Complete product

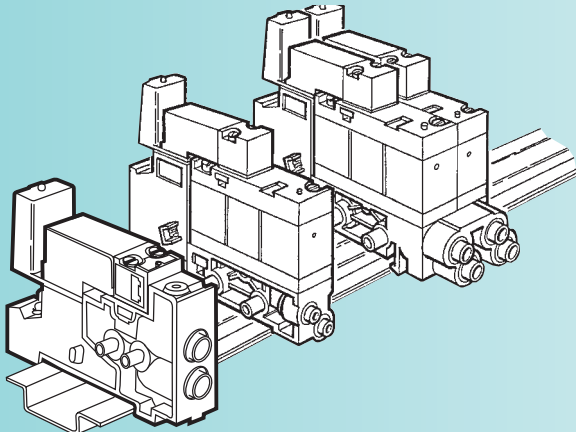

## Valve modules

- › Monostable, bistable
- › 3/2, 4/2



Also available in **ATEX** version for use in potentially explosive atmospheres in accordance with 94/9/EC Directive

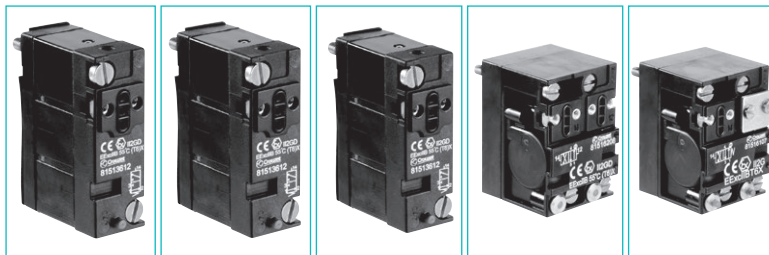

81 513 100

81 513 600

81 513 200

81 516 200

81 516 100

Function	3/2 NC monostable	3/2 NO monostable	4/2 monostable	4/2 bistable	4/2 monostable
----------	-------------------	-------------------	----------------	--------------	----------------

### Symbol

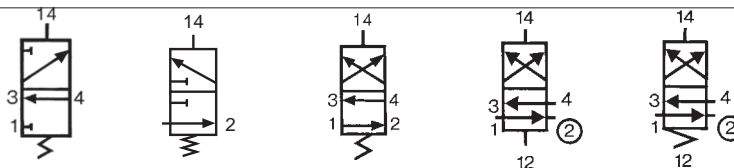

### Characteristics

Width	mm	17.5	17.5	17.5	35	35	
Working pressure	bars	3→8	3→8	3→8	2→8	3.5→8	
Orifice diameter	mm	3	3	3	4	4	
Flow at 6 bars	with Ø 4 mm sub-base (page 63)	200	200	200	300	300	
	with Ø 6 mm sub-base (page 63)	Nl/min	300	300	400	400	
Flow Rate	with Ø 4 mm sub-base (page 63)	kV	2.2	2.2	2.2	4	4
	with Ø 6 mm sub-base (page 63)		2.5	2.5	4	5	5
Operating temperature	° C	-10 → +50	-10 → +50	-10 → +50	-10 → +50	-10 → +50	
Switching time for the valve only	ms	15	15	15	50	50	
Mechanical life	operations	1.5 x 10 <sup>7</sup>	1.5 x 10 <sup>7</sup>	1.5 x 10 <sup>7</sup>	10 <sup>7</sup>	10 <sup>7</sup>	
Weight	g	38	38	38	106	106	

### Dimensions

#### 81 513

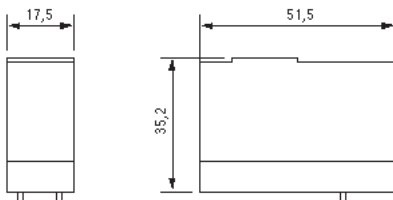

#### 81 516

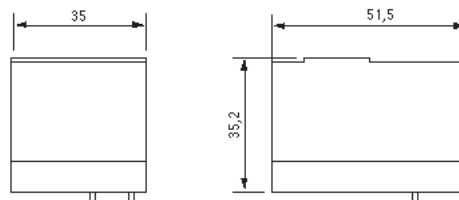

## Sub-bases and end bases for miniature control valves



Also available in **ATEX** version for use in potentially explosive atmospheres in accordance with 94/9/EC Directive

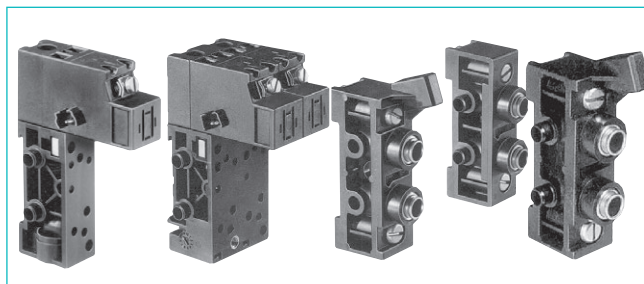

### Part numbers

Mounting			Cabinet	Cabinet	Cabinet	Cabinet
Version			17.5 mm	35 mm	—	—
Push-in connection for semi-rigid tubing (NFE 49100)	Sub-bases	Ø 4 mm	81 513 060	81 517 101	—	—
		Ø 6 mm	81 513 065	81 517 201	—	—
	End bases (pair)	Ø 6 mm	—	—	81 513 011	—
	Intermediate supply module	Ø 6 mm	—	—	—	81 513 001

### Characteristics

Torque capacity	mm²	3	3	—	—
UL and cUL approval		MM15085	MM15085	—	—
Mounting		DIN rail 35 mm	DIN rail 35 mm	DIN rail 35 mm	DIN rail 35 mm
Weight	g	55	110	86	44

### Connections Pneumatic



2 - Pneumatic output 4/2 (NO)  
4 - Pneumatic output 3/2 or 4/2 (NC)

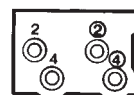

2 Output at rest (NO)  
3 Output at rest \*  
4 Output at rest \*  
5 Output operating (NC)

81 513 011 - 81 513 001

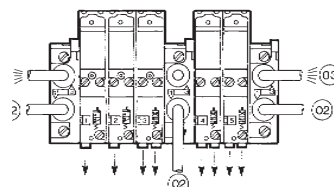

**Note :**

Each sub-base can accept  
- sub-base 81 513 060-065 : 1 relay 3/2 or 4/2, width 17.5 mm  
- sub-base 81 517 101-201 : 1 bistable relay 4/2 (width 35 mm) or 2 relays 3/2 or 4/2 (width 17.5 mm)

02 2 Supply ports  
03 2 Exhaust ports

Integral push-in connections Ø 6 mm

### Electrical



A1 - Pilot signal  
A2 - Common

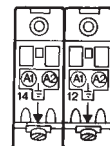

A1 - Operating control signal (14)  
A2 - Common  
A1 - Rest control signal (12)  
A2 - Common



Degree of protection : IP20 when assembled.

### Dimensions with miniature control valves (page 62) + miniature solenoid valves (page 58) + indicators (page 65)

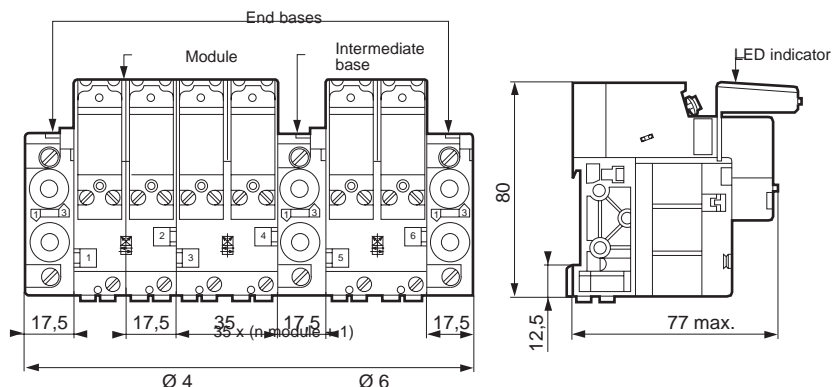

ATEX version products are available in the following catalogues: **Pneumatic products for explosive atmospheres** or on our website [www.crouzet-control.com](http://www.crouzet-control.com)

# Valves and solenoids valves assembled

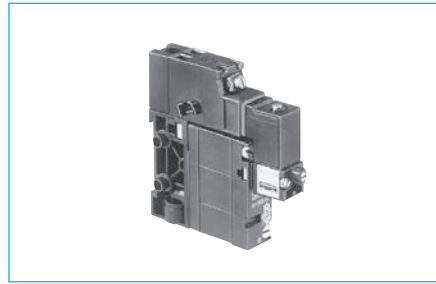

**Contact us for  
Other versions**

### Part numbers

Function	3/2 NC	4/2 monostable
Sub-base with push-in connection for semi-rigid tubing (NFE 49100)	Ø 4 ext.	Ø 4 ext.
Version	Solenoid valve with manual override by impulse	Solenoid valve with manual override by impulse
Voltage	24 VDC (+10% -15%)	81 513 103
		81 513 203

### Symbol



### Characteristics

Operating pressure	bar	3→8	3→8
Orifice diameter	mm	3	3
Flow at 6 bars	NL/min	200	200
KV		2.2	2.2
Operating temperature	°C	-10 → +50	-10 → +50
Switching time of the assembly	ms	20	20
Mechanical life (operations at 4 bars)		1.5 x 10 <sup>7</sup>	1.5 x 10 <sup>7</sup>
Valve position will be maintained in the event of pressure loss and/or electrical current loss		—	—
Mounting		DIN rail 35 mm	DIN rail 35 mm
Weight	g	130	130
UL and cUL approval		MH15085	MH15085

### Principle of operation

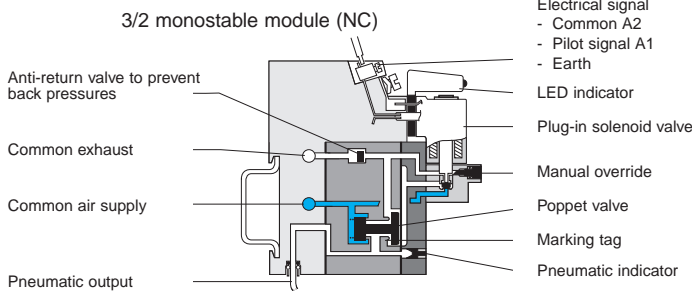

### 4/2 monostable module

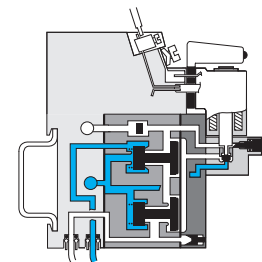

### 4/2 bistable module

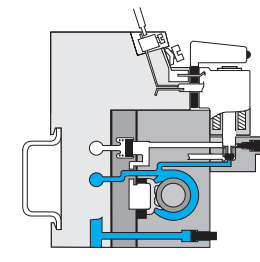

### Dimensions

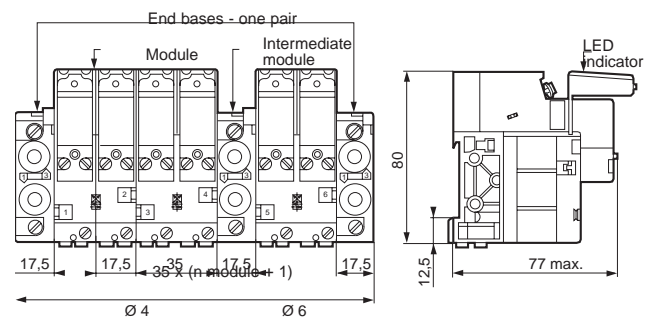

End bases not supplied (page 63)  
Intermediate bases not supplied (page 63)  
Indicators not supplied (page 65)



# Accessories



Also available in **ATEX** version for use in potentially explosive atmospheres in accordance with 94/9/EC Directive

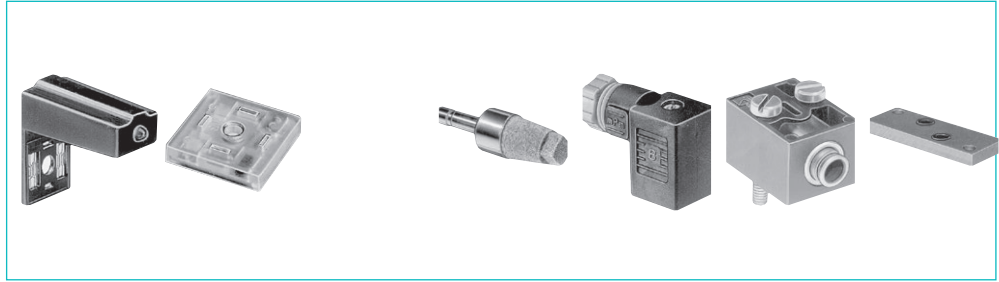

## Part numbers

Visual indicators with anti-surge	24 V - 50-60 Hz ~	81 513 052	—	—	—	—	—	—
	48 V - 50-60 Hz ~	81 513 055	—	—	—	—	—	—
	110 V - 50-60 Hz ~	81 513 058	—	—	—	—	—	—
	230 V - 50-60 Hz (-10% +6 %)	81 513 059	—	—	—	—	—	—
LED seal Packaging	12 to 24 V - DC - AC	— (by 5)	81 513 064 (by 10)	—	—	—	—	—
Exhaust silencer	Plug-in Ø 6	—	—	81 537 001	—	—	—	—
	Plug-in Ø 8	—	—	81 537 201	—	—	—	—
Connector for solenoid valve		—	—	—	81 516 082	—	—	—
Pneumatic pilots	Without manual override	—	—	—	—	81 516 081	—	—
	With manual override by impulse	—	—	—	—	81 516 091	—	—
Push-in connection for semi-rigid tubing Ø 4 mm (NFE 49100)		—	—	—	—	—	•	—
Blanking plate		—	—	—	—	—	—	81 516 085

## Symbol

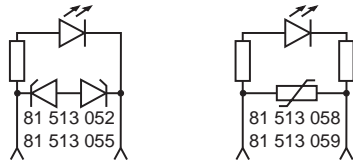

## Characteristics

Consumption	W	—	0.24	—	—	—	—	—
Temperature	°C	—	- 10 → +50	—	—	—	—	—
Connection	mm	—	—	—	—	—	Instantané Ø 4 ext.	—
Mounted between the pilot solenoid valve and the body of the module		•	•	—	—	—	—	—
Supplied in multiples of 5		•	—	—	—	—	—	—
Supplied in multiples of 10		—	•	—	—	•	•	•
Packet of 10 pieces		—	—	—	—	—	—	•
Weight	g	6	2	30	10	5	3	—

## Connection

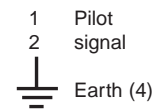

## Dimensions

### 81 537 001 - 81 537 201

Mounted by plugging into push-in connector for semi-rigid tubing (NFE 49100)

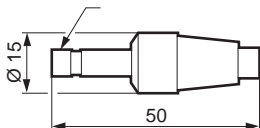

### 81 513 052 - 81 513 055

### 81 513 058 - 81 513 059

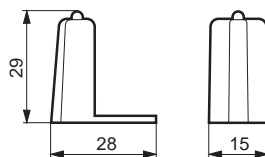

### 81 516 082

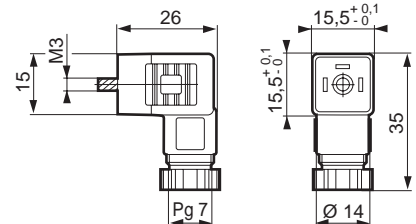

ATEX version products are available in the following catalogues: **Pneumatic products for explosive atmospheres** or on our website [www.crouzet-control.com](http://www.crouzet-control.com)

# Solenoid valves

- › Reduced "dimensions"
- › Mounted on sub-base

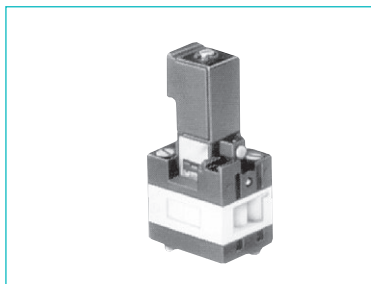

### Part numbers and voltages

Function		3/2 NC	
Mounting		On sub-base (54)	
Solenoid valves	24 V (+10% -15%)	81 519 732	
with	24 V - 50/60 Hz (+10% -15%)	81 519 774	
manual	48V - 50/60 Hz (+10% -15%)	81 519 775	
override	110 V - 50/60 Hz (+10% -15%)	81 519 776	
by impulse	220 - 230 V - 50/60 Hz (+10% -15%)	81 519 777	

### Symbol

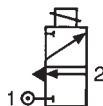

### Characteristics

Operating pressure	bar	2 → 8	
Orifice diameter	mm	2.7	
Flow at 6 bars	NI/min	170	
Rotatable coil 4 positions in 90° steps		•	
Degree of protection (with connector 81 516 082 not supplied) (see page 65)	IEC 529	IP 65	
Mechanical life	operations	1.5 x 10 <sup>7</sup>	
Consumption	W	1	
	VA	2.5	
Operating temperature	°C	-5 → +50	
Weight	g	70	
UL and cUL approval		MH15085	

### Principle of operation

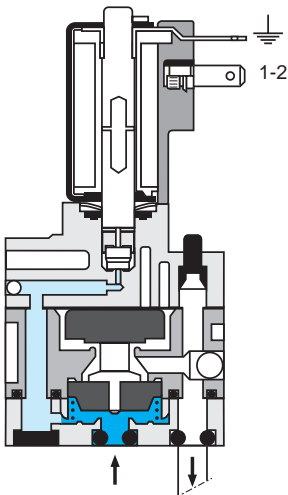

### Connections

- Pneumatic { 1 - Supply  
2 - Output
- Electrical { 1 - 2 - Pilot signal  
⊥ Earth

Electrical connection by connector 81 516 062 (see page 65)

### Dimensions

81 519

On separate sub-base

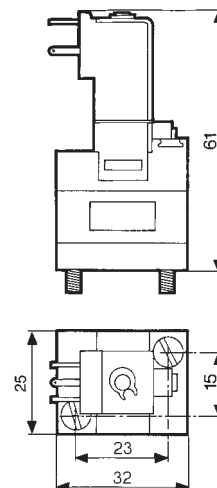

# Miniature control valves, 17.5 mm

## → Electro-pneumatic interface block

Complete block, ready to install, consisting of:

- Preconfigured 8-position sub-base
- 6 4/2 monostable valve modules with 24 V $\overline{\text{DC}}$  pilot holes
- 2 blanking plates (for extension if necessary)
- 1 connection cable



### Part numbers

Part numbers	16 outputs 81513241	16 outputs 81513238
<b>Electrical characteristics</b>		
Supply voltage	24 V $\overline{\text{DC}}$ $\pm$ -10%	24 V $\overline{\text{DC}}$ $\pm$ -10%
Courant max. absorbé sur le 24 V de SUBD (mA)	500	500
Courant absorbé par chaque électrovanne	60	60
Response time (ms)	15	15
LED display	Yes (integrated in the sub-base)	Yes (integrated in the sub-base)
Protection against voltage surges	Yes	Yes
<b>Electrical connections</b>		
Type of cable	Sub D9 AWG 24 wires	Sub D9 AWG 24 wires
Cable length	2 m	2 m
<b>Pneumatic characteristics</b>		
Function	6 4/2 monostable valve modules (81513200) + 2 free positions	Whitout
Operating pressure bars	3 $\rightarrow$ 8 b	3 $\rightarrow$ 8 b
Flow at 6 bars NL/mim	300	300
Mechanical life (operations)	1.5 x 10 <sup>7</sup>	1.5 x 10 <sup>7</sup>
Working medium	Compressed air or inert gas, 50 $\mu$ m filtered non-lubricated air	Compressed aire or inet gaés, 50 $\mu$ m filtered non-lubricated air
<b>Pneumatic connections</b>		
Power supply connection	Push-in connection $\varnothing$ 8 mm	Push-in connection $\varnothing$ 8 mm
Output connections	Push-in connection $\varnothing$ 6 mm	Push-in connection $\varnothing$ 6 mm
Connection of common exhaust	Push-in connection $\varnothing$ 8 mm	Push-in connection $\varnothing$ 8 mm
<b>General characteristics</b>		
Operating temperature range IEC 68214 (°C)	-5 $\rightarrow$ +50	-5 $\rightarrow$ +50
Storage temperature IEC 68-2-14 (°C)	-15 $\rightarrow$ +50	-15 $\rightarrow$ +50
Protection (IEC/EN 60529)	IP 20	IP20
Mounting	On DIN rail or via two M5 screws (according to mounting plan)	On DIN rail or via two M5 screws (according to mounting plan)
Weight (g)	1350	960
<b>Comments</b>		
Other configurations on request		

### Dimensions (mm)

81513241

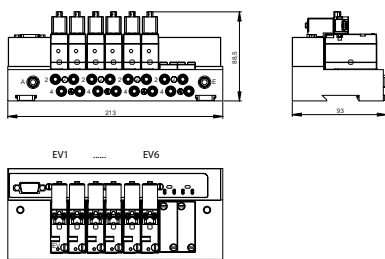

### Connections

Connector wiring

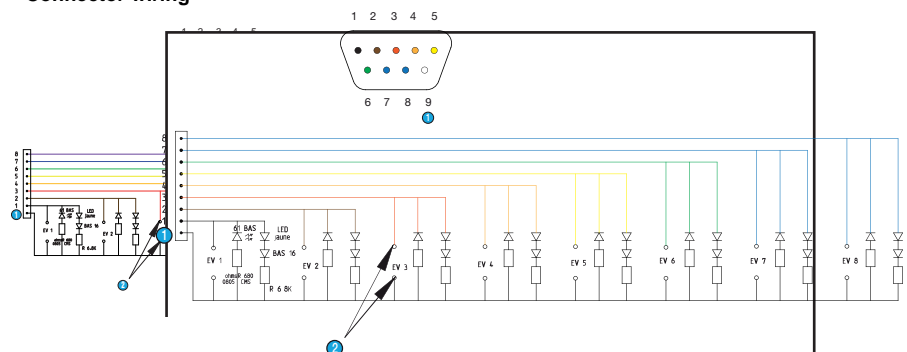

- ① Commun 0 V
- ② Clips femelle CI

## ► Specific islands "for integrators" (supplied in packs of 20)

### ► Versions with interfaces 300 NL / mm

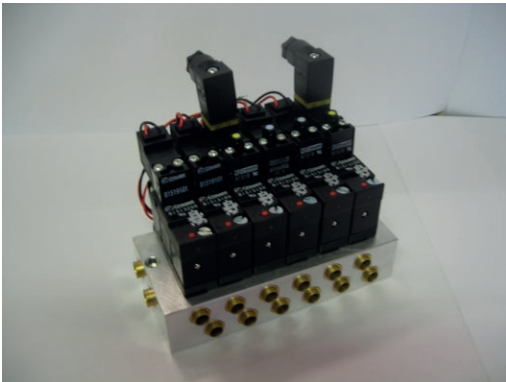

#### Configuration

- 1 - Specify the number and type of interfaces (3 / 2 mono - 4 / 2 mono - 4 / 2 bistable) see page 62.
- 2 - Specify the voltage, the type and method of the control valve connections, see page: 58-59 (Example: 24 V DC with manual switch maintained, exit leads).
- 3 - Please send us your application specifying your requirements and quantities per year, and we will respond as soon as possible.

### ► Versions with interfaces 30 NL / mm



#### Configuration

- 1 - Specify the voltage, the type and method of the control valve connections, see page: 58-59 (Example: 24 V DC with manual switch maintained, exit leads).
- 2 - Please send us your application specifying your requirements and quantities per year, and we will respond as soon as possible.

### ► Develop customised versions to specifications

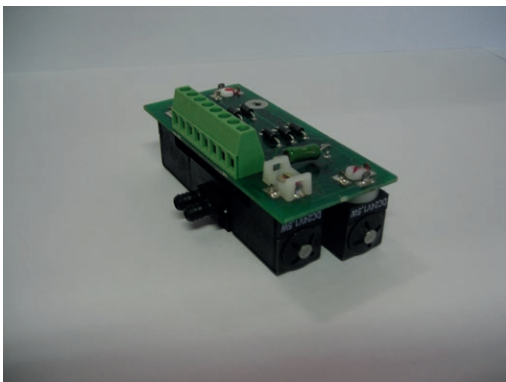

Crouzet analyses your needs and offers a customised solution.

# **MULTI-FLUID SOLENOID VALVES**

## Standard 2/2 miniature solenoid valves for fluids and inert gases

- › Autonomous
- › Mounted individually or in a battery
- › Variable orientation coil
- › Low power consumption : 1 W
- › Quick to fit together, no tools needed
- › M5 fittings or possibility of barb

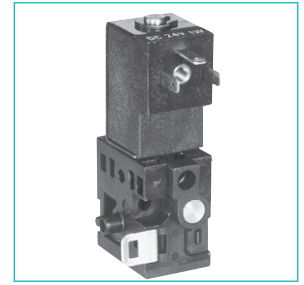
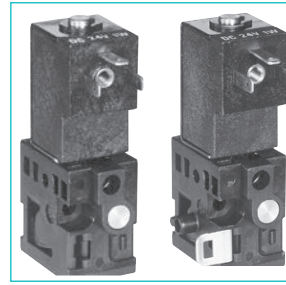
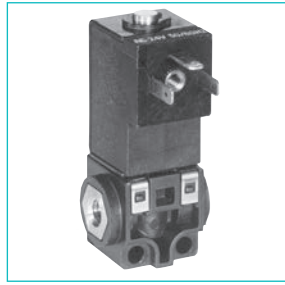

Mounting

Individual

Bank end valves (1 pair)

Intermediate valve

### Part numbers

Orifice diameter	KV	Adjustment range	Power	NC	NC	NC
0.8 mm	0.3	1 • 8 b	1W	<b>81 546 001</b>	<b>81 547 001</b>	<b>81 547 501</b>

### Standard features

Voltage	24V $\sim$
Electrical connections	2.8 x 0.5 blade terminals (W7D5) at 9.4 mm centres
Fluid connection	tapped holes M5
Manual override + pressure indicator	without

### General characteristics

Response time	5 → 15 ms
Operating temperature	- 5 °C → +50 °C
Viscosity range	up to 30 cst
Vibration resistance	up to 5 g
Air flow rate (at 2 bars)	15 → 40 NI/mn
Maximum switching rate	30 Hz
Weight	Individual mounting: 32.5 g Bank end/inner valves: 35 g
Body material	Glass-reinforced polyamide 6.6
Mechanical life (operations)	1.5 x 10 <sup>7</sup>
UL and cUL approval	MH 15085

### Accessories for 2/2 miniature solenoid valves

Connector for solenoid valve (see page 65)	<b>81 516 082</b>
Visual indicators (see page 65)	24 V-50/60 Hz CC: <b>81 513 052</b> 48 V-50/60 Hz AC: <b>81 513 055</b> 110 V-50/60 Hz AC: <b>81 513 058</b> 220 V-50/60 Hz AC: <b>81 513 059</b>
LED seal (see page 65)	12-24 V $\sim$ $\sim$ : <b>81 513 064</b>

### Dimensions

#### Individual

81 546 0

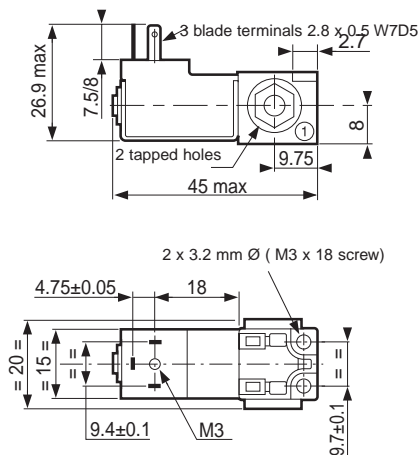

#### Bank end valves (1 pair)

81 547 0

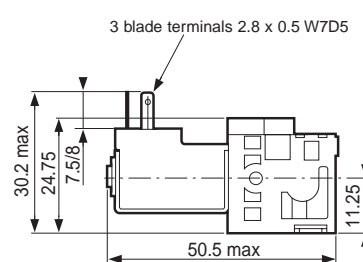

#### Intermediate valve

81 547 5

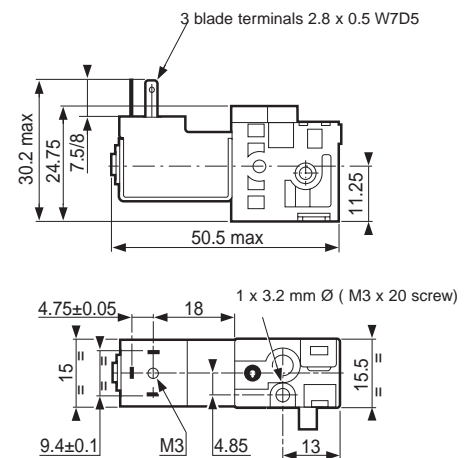

# Standard 3/2 miniature solenoid valves for fluids and inert gases

- › Autonomous
- › Mounted individually or in a battery
- › All connections on one face
- › Small size

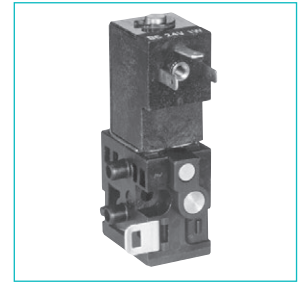
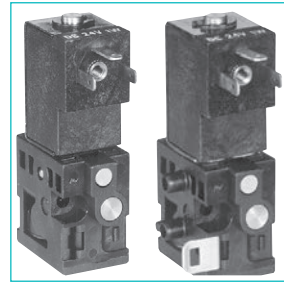
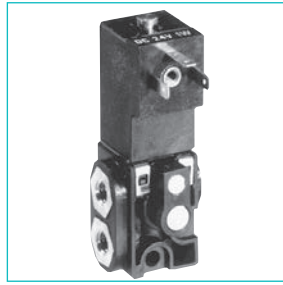

Mounting

Individual

Bank end valves (1 pair)

Intermediate valve

## Part numbers

Orifice diameter	KV Débit	Adjustment range	Power	NC	NC	NC
0.8 mm	0.3 25	1 • 8 b	1W	81 548 010	81 549 010	81 549 510
0.8 mm	0.3	1 • 8 b	2W			
1.2 mm	0.6 40	- 0.9 • 3 b	2W	81 548 011	81 549 011	81 549 511
1.5 mm	0.8 60	0 • 2 b	2W	81 548 012	81 549 012	81 549 512

## Standard features

Voltage	24V ---
Electrical connections	2.8 x 0.5 blade terminals (W7D5) at 9.4 mm centres
Fluid connection	tapped holes M5
Manual override	by impulse
Pressure indicator	without

## General characteristics

Response time	5 → 15 ms
Operating temperature	- 5 °C → +50 °C
Viscosity range	up to 30 cst
Vibration resistance	up to 5 g
Air flow rate (at 2 bars)	15 → 40 NI/min
Maximum switching rate	30 Hz
Weight	Individual mounting: 32.5 g Bank end/inner valves: 35 g
Body material	Glass-reinforced polyamide 6.6
Mechanical life (operations)	1.5 x 10 <sup>7</sup>
UL and cUL approval	MH 15085

## Accessories for 3/2 miniature solenoid valves

Connector for solenoid valve (see page 5/11)	81 516 082	
Visual indicators (see page 65)	24 V-50/60 Hz DC	81 513 052
	48 V-50/60 Hz AC	81 513 055
	110 V-50/60 Hz AC	81 513 058
	220 V-50/60 Hz AC	81 513 059
LED seal (see page 65)	12-24 V ~ ---	81 513 064

## Dimensions

### Individual

81 548 0

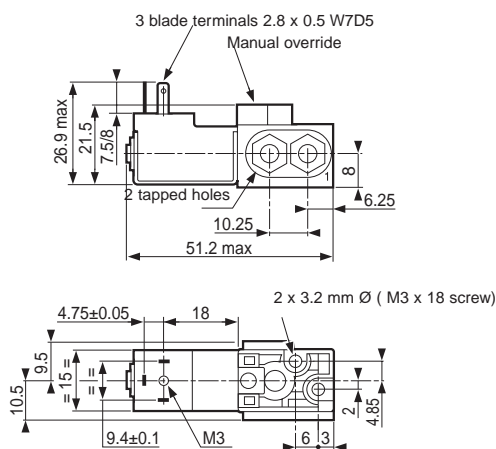

### Bank end valves (1 pair)

81 549 0

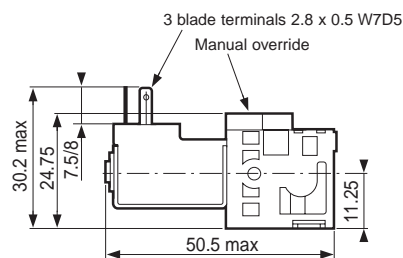

### Intermediate valve

81 549 5

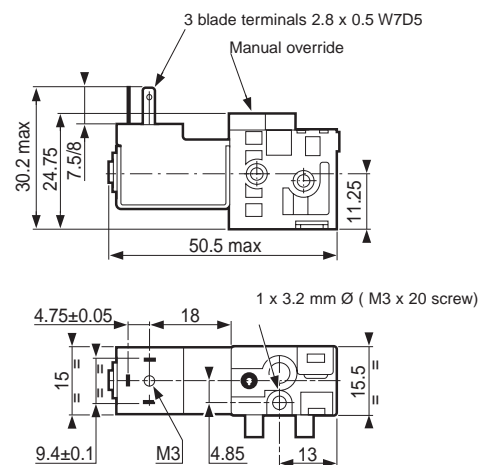

# TEACHING MATERIALS



## Teaching materials

- › Ideal for learning pneumatics
- › For high schools, colleges and training centres

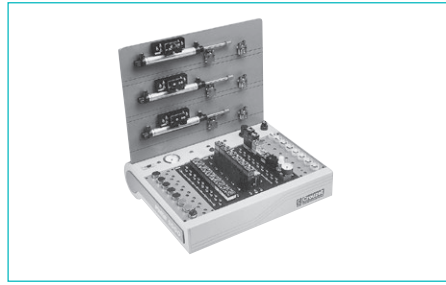

Part numbers		
Training console PUMA 2000	81 598 940	—
Add-on unit	—	81 598 941
Weight (kg)	30	4

Characteristics		
Maintained sequencer sub-base assembly	●	—
1 relay sub-base	●	—
1 peripheral sub-base	●	—
1 plate with 8 push-buttons	●	—
1 plate with 8 indicators	●	—
1 basic console	●	—
1 cylinder mounting plate (3 cylinders + control valves + position detectors)	●	—
2 electro-pneumatic interface units	—	●
1 pneumo-electrical interface unit	—	●

### Dimensions

81 598 940

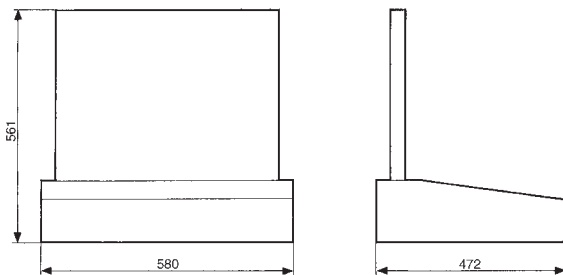

## List of part numbers

Industrial part no.	ATEX part no.	Type	Pages
<b>24 000 000</b>			
24 678 127		Pushbutton	15
24 678 128		Pushbutton	15
24 678 129		Pushbutton	15
24 678 171		Mushroom button	15
24 678 172		Mushroom button	15
24 678 173		Mushroom button	15
24 678 174		Symmetrical toggle	15
24 678 175		Lever toggle	15
24 678 176		Symmetrical toggle	15
24 678 177		Lever toggle	15
24 678 178		Symmetrical toggle	15
24 678 179		Lever toggle	15
24 678 180		Key toggle	15
24 678 181		Key toggle	15
24 678 182		Key toggle	15
24 679 702		Adaptor	14
<b>79 000 000</b>			
79 451 698	79 451 698	Adaptor	50
79 451 903	79 451 903	Adaptor	50
79 451 904	79 451 904	Adaptor	51
79 451 905	79 451 905	Adaptor	51
79 452 103		Lever	28
79 452 104		Lever	28
79 452 123		Lever	28
79 452 124		Lever	28
79 452 133		Lever	28
79 452 808	79 458 018	Capacity	52
<b>81 000 000</b>			
81 280 010		NO Microvalve	13-24
81 280 510		NF Microvalve	13-24
81 281 010		NO Microvalve	13-24
81 281 502		Limit switch	25
81 281 504		Limit switch	25
81 281 508		Limit switch	25
81 281 509		Limit switch	25
81 281 510		NF Microvalve	13-24
81 283 510		NF Microvalve	24
81 290 001	81 290 006	Low-force detector	23
81 290 501	81 290 506	Low-force detector	23
81 371 401		Special detector	32
81 372 201		Special detector	32
81 372 401		Special detector	32
81 372 901		Special detector	32
81 501 025	81 501 031	YES element	47
81 502 110	81 502 111	Vacuum switch	39
81 502 140	81 502 141	Pressure switch	38
81 502 150	81 502 151	Pressure switch	38
81 502 160	81 502162	Pressure switch	38
81 502 230	81 502 238	Amplifier	33
81 502 320	81 502 322	Amplifier	33
81 502 435	81 502 438	Relay for leak detector	31
81 503 025	81 503 028	YES element	47
81 503 540	81 503 543	Timer	49
81 503 710	81 503 728	Timer	50
81 503 720	81 503 729	Timer	50
81 503 725	81 503 731	Timer	50
81 504 025	81 504 035	NO element	22-47
81 505 110	81 505 111	Vacuum switch	39
81 505 140	81 505 141	Pressure switch	38
81 505 150	81 505 151	Pressure switch	38
81 505 160	81 505 164	Pressure switch	38
81 505 230	81 505 231	Amplifier	33
81 505 320	81 505 321	Amplifier	33
81 505 435	81 505 437	Relay for leak detector	31
81 506 025	81 506 027	NO element	47
81 506 710	81 506 714	Timer	50
81 506 720	81 506 721	Timer	50
81 506 725	81 506 727	Timer	50
81 506 940	81 506 945	Frequency generator	51
81 507 540	81 507 543	Frequency generator	51

Industrial part no.	ATEX part no.	Type	Pages
81 507 720	81 507 724	Frequency generator	51
81 508 110		Vacuum switch	39
81 509 080		Pressure switch	37
81 509 085		Pressure switch	37
81 510 001		Amplifier relay	34
81 512 201		Special detector	31
81 512 401		Special detector	31
81 513 001	81 513 039	Supply module	63
81 513 011	81 513 040	End base	63
81 513 052		LED	65
81 513 055		LED	65
81 513 058		LED	65
81 513 059		LED	65
81 513 060	81 513 075	Sub-base	63
81 513 064		Indicator seal	65
81 513 065	81 513 076	Sub-base	63
81 513 100	81 513 196	Valve module	62
81 513 103		Valve module	64
81 513 200	81 513 234	Valve module	62
81 513 203		Valve module	64
81 513 501		Pressure switch	36
81 513 502		Pressure switch	36
81 513 509		Pressure switch	37
81 513 510		Pressure switch	37
81 513 516		Pressure switch	37
81 513 522		Vacuum switch	36
81 513 523		Vacuum switch	37
81 513 527		Vacuum switch	37
81 513 533		Pressure switch	37
81 513 552		Pressure switch	36
81 513 600	81 513 612	Valve module	62
81 516 081	81 516 093	Pneumatic pilot	65
81 516 082		Connector	65
81 516 085	81 516 085	Blanking plate	65
81 516 091		Accessories	65
81 516 100	81 516 107	Valve module	62
81 516 200	81 516 208	Valve module	62
81 517 101	81 517106	Sub-base	63
81 517 201	81 517 206	Sub-base	63
81 519 032	81 519 035	Miniature solenoid valve	59
81 519 080		Miniature solenoid valve	58
81 519 332	81519 335	Miniature solenoid valve	59
81 519 340		Miniature solenoid valve	59
81 519 378		Miniature solenoid valve	58
81 519 379		Miniature solenoid valve	58
81 519 380		Miniature solenoid valve	58
81 519 381		Miniature solenoid valve	58
81 519 632	81 519 635	Miniature solenoid valve	59
81 519 678		Miniature solenoid valve	58
81 519 679		Miniature solenoid valve	58
81 519 680		Miniature solenoid valve	58
81 519 732		Valve module	66
81 519 774		Valve module	66
81 519 775		Valve module	66
81 519 776		Valve module	66
81 519 777		Valve module	66
81 520 601	81 520 602	Plug-element	53
81 521 501	81 521 508	OR element	46
81 522 501	81 522 505	AND element	46
81 523 201	81 523 205	Memory	48
81 523 601	81 523 608	Memory	48
81 525 101	81 525 106	Flow restrictor	52
81 526 001	81 526 006	Flow restrictor	52
81 527 001		Mini-regulator	53
81 529 003	81 529 013	Flow restrictor	52
81 529 004	81 529 014	Flow restrictor	52

## List of part numbers

Industrial part no.	ATEX part no.	Type	Pages
81 529 005	81 529 015	Flow restrictor	52
81 529 006	81 529 016	Flow restrictor	52
81 529 007	81 529 017	Flow restrictor	52
81 529 008	81 529 018	Flow restrictor	52
81 529 010	81 529 020	Flow restrictor	52
81 529 025	81 529 026	Flow restrictor	52
81 529 901	81 529 907	Non-return	53
81 531 001	81 531 008	Sub-base	55
81 532 001	81 532 009	Sub-base	55
81 532 102	81 532 109	Sub-base	54
81 532 104	81 532 111	Sub-base	54
81 533 001	81 533 001	Clip domino	56
81 533 501	81 533 501	Hole domino	56
81 535 301	81 535 303	Vacuum generator	40
81 536 801	81 536 804	Supply base	56
81 540 001	81 540 015	OR element	46
81 540 005	81 540 017	OR element	46
81 541 001	81 541 015	AND element	47
81 541 005	81 541 017	AND element	47
81 542 002	81 542 004	Sub-base	55
81 545 001	81 545 012	Vacuum generator	40
81 545 005	81 545 013	Vacuum generator	40-70
81 546 001		Miniature solenoid valve	40-70
81 547 001		Miniature solenoid valve	70
81 547 501		Miniature solenoid valve	70
81 548 010		Miniature solenoid valve	71
81 548 011		Miniature solenoid valve	71
81 548 012		Miniature solenoid valve	71
81 549 010		Miniature solenoid valve	71
81 549 011		Miniature solenoid valve	71
81 549 012		Miniature solenoid valve	71
81 549 510		Miniature solenoid valve	71
81 549 511		Miniature solenoid valve	71
81 549 512		Miniature solenoid valve	70
81 550 001	81 550 013	Register module	43
81 550 201	81 550 213	Register module	43
81 550 401	81 550 403	Register module	43
81 550 601	81 550 603	Register module	43
81 551 001	81 551 004	Sub-base	45
81 551 101	81 551 104	Sub-base	44
81 552 001	81 552 005	Sub-base	45
81 552 101	81 552 105	Sub-base	44
81 552 601	81 552 605	Diversion base	44
81 580 101		Pneumatic relay	17
81 580 202		Pneumatic relay	17
81 580 503		Two-hand control module	18
81 580 504		Two-hand control module	18
81 598 940		Teaching materials	73
81 598 941		Teaching materials	73
81 715 511		Push buttons and actuators	12
81 715 512		Push buttons and actuators	12
81 716 511		Push buttons and actuators	12
81 716 512		Push buttons and actuators	12
81 733 511		Push buttons and actuators	12
81 735 011		Push buttons and actuators	12
81 735 511		Push buttons and actuators	12
81 735 512		Push buttons and actuators	12
81 737 501		Limit switch	25
81 921 501		Miniature detector	26
81 921 505		Miniature detector	30
81 921 701		Miniature detector	26
81 921 702		Miniature detector	26
81 921 707		Miniature detector	26
81 921 714		Miniature detector	27
81 921 717		Miniature detector	27
81 921 719		Miniature detector	27
81 921 806		Miniature detector	27
81 921 901		Miniature detector	27
81 921 902		Miniature detector	27

Industrial part no.	ATEX part no.	Type	Pages
81 921 911		Miniature detector	27
81 921 912		Miniature detector	27
81 922 010		Compact detector	28
81 922 205		Compact detector	28
81 922 210		Compact detector	28
81 922 401		Compact detector	28
81 923 001		Special detector	30
81 999 501		Control pedal	20
84 000 000			
84 150 201	84 150 214	Indicator	20
84 150 202	84 150 215	Indicator	20
84 150 203	84 150 216	Indicator	20
84 150 204	84 150 217	Indicator	20
89 000 000			
89 538 201		Counter	19
89 543 101		3/2 NO valve	14
89 543 201		3/2 NO valve	14
89 543 501		3/2 NF valve	14
89 543 701		3/2 NF valve	14
89 543 005		3/2 NO valve + adaptor	14
89 543 105		3/2 NF valve + adaptor	14
89 543 205		3/2 NF valve+3/2 NO valve+adaptor	14
89 543 305		3/2 NF valve+3/2 NF valve+adaptor	14
99 000 000			
99 766 001		Counter	19
99 766 002		Counter	19