

ELECTRO-PNEUMATIC CONTROL VALVES

Miniature solenoid valves for alternating current

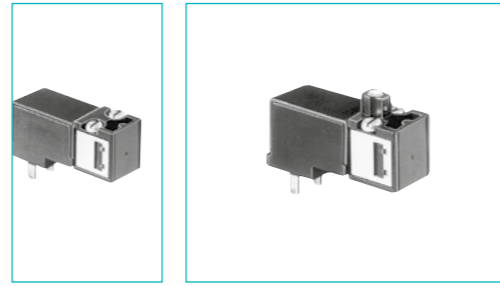

- Conform to the Low Voltage Directive
- For mounting on sub-base or footprint in accordance with CNOMO recommendation E-06-36-120N

Part numbers (and voltages)		81 519 080	81 519 380	81 519 680
Consumption	Voltage			
2.5 VA	24 V ~ 50-60 Hz	—	81 519 381	—
2.5 VA	48 V ~ 50-60 Hz*	—	81 519 378	81 519 678
2.5 VA	110 V ~ 50-60 Hz	—	81 519 379	81 519 679
2.5 VA	220 V- 230 V ~ 50-60 Hz	—		
Function		3/2 NC	3/2 NC	3/2 NC
Version		Without manual override	With manual override by impulse	With manual override by latching (1/4 turn)

Characteristics		81 519 080	81 519 380	81 519 680
Operating pressure	bar	1 → 8	1 → 8	1 → 8
Orifice diameter	mm	0.5	0.5	0.5
Flow at 6 bars	NI/min	12	12	12
kV		0.12	0.12	0.12
Switching time	ms	5 → 15	5 → 15	5 → 15
Mechanical life (operations)		5 10 ⁷	5 10 ⁷	5 10 ⁷
Operating temperature	°C	-10 → +50	-10 → +50	-10 → +50
Compressed air or inert gas - oil-free air filtered to 50 μ		•	•	•
Duty factor		100 % ED	100 % ED	100 % ED
Insulation class	IEC 85	F	F	F
Weight		35	35	35
Rotatable connector 4 positions in 90° steps		•	•	•
Degree of protection with sub-base (page 62)	IEC 529	IP 20	IP 20	IP 20
Degree of protection with connector 81 516 082 (page 65)	IEC 529	IP 65	IP 65	IP 65
UL and cUL approval		MH 15085	MH 15085	MH 15085

15x15 mm footprint
according to CNOMO E 06-36-120N

Dimensions 81 519 0
81 519 3
81 519 6

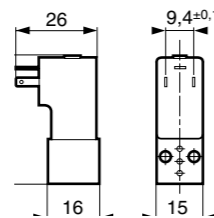
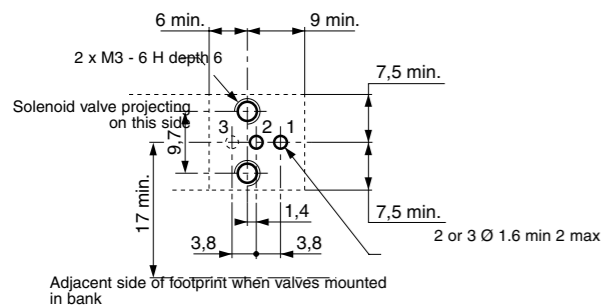

Manual override

- 1 - Supply
- 2 - Output
- 3 - Exhaust

Miniature solenoid valves for direct current

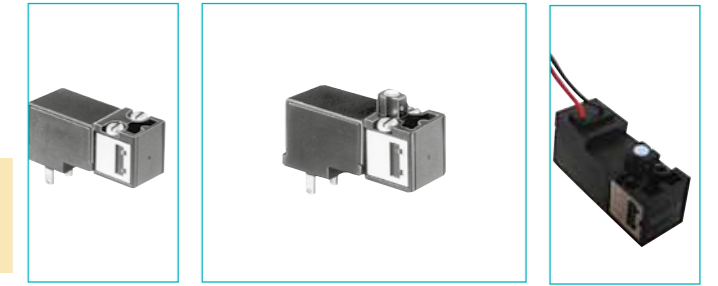

- Conform to the Low Voltage Directive
- For mounting on sub-base or footprint in accordance with CNOMO recommendation E-06-36-120N

Also available in ATEX version for use in potentially explosive atmospheres in accordance with 94/9/EC Directive

Part numbers (and voltages)		81 519 032	81 519 332	81 519 632	81 519 340
Consumption	Voltage				
1 W	24 V =				
Function		3/2 NC	3/2 NC	3/2 NC	3/2 NF
Version		Without manual override	With manual override by impulse	With maintained manual override	With maintained manual override

Characteristics		81 519 032	81 519 332	81 519 632	81 519 340
Operating pressure	bar	1 → 8	1 → 8	1 → 8	1 → 8
Orifice diameter	mm	0.8	0.8	0.8	0.8
Flow at 6 bars	NI/min	25	25	25	25
kV		0.3	0.3	0.3	0.3
Switching time	ms	5 → 15	5 → 15	5 → 15	5 → 15
Mechanical life (operations)		5 10 ⁷	5 10 ⁷	5 10 ⁷	5 10 ⁷
Operating temperature	°C	-10 → +50	-10 → +50	-10 → +50	-10 → +50
Compressed air or inert gas - oil-free air filtered to 50 μ		•	•	•	•
Duty factor		100 % ED	100 % ED	100 % ED	100 % ED
Insulation class	IEC 85	F	F	F	F
Weight		35	35	35	35
Rotatable connector 4 positions in 90° steps		•	•	•	•
Degree of protection with M12 5-pin connector	IEC 529	—	—	—	—
Degree of protection with connector 81 516 082	IEC 529	IP 65	IP 65	IP 65	IP 65
UL and cUL approval		MH 15085	MH 15085	MH 15085	MH 15085

15x15 mm footprint
according to CNOMO E 06-36-120N

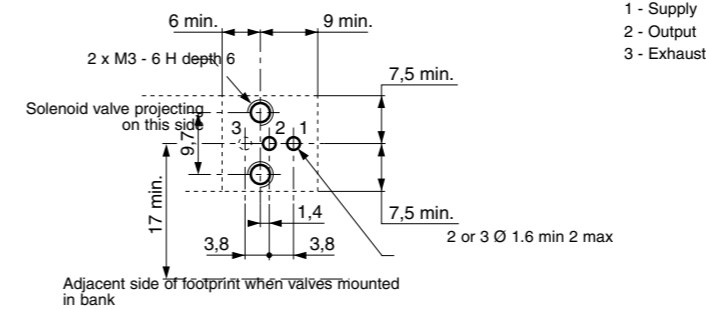

Encombrement 81 519 0

81 519 3
81 519 6

81 519 3

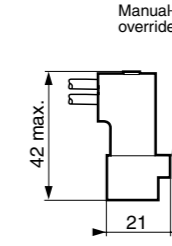
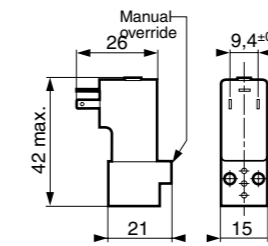
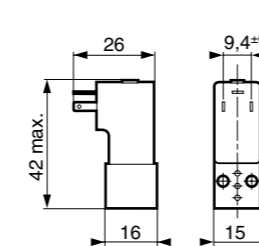

ATEX version products are available in the following catalogues: **Pneumatic products for explosive atmospheres** or on our website www.crouzet.com

Electro-pneumatic miniature control valves

Mounting

Miniature solenoid valves

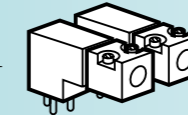

Indicators

- LED seals
- LED

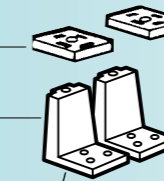

Valve modules

- Poppet
 - 3/2 monostable (17.5 mm)
 - 4/2 monostable (17.5 mm)
- Slide valve
 - 4/2 bistable (35 mm)
 - 4/2 monostable spring-return (35 mm)

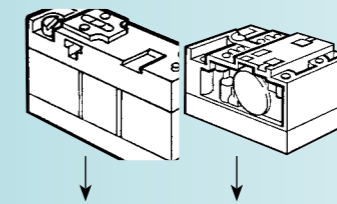

Sub-bases

For miniature solenoid valves

For valve modules

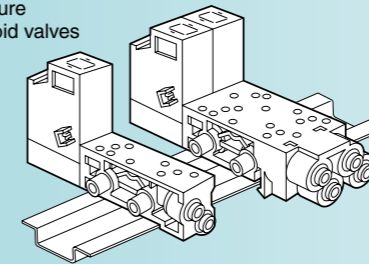

Single

Double

Complete product

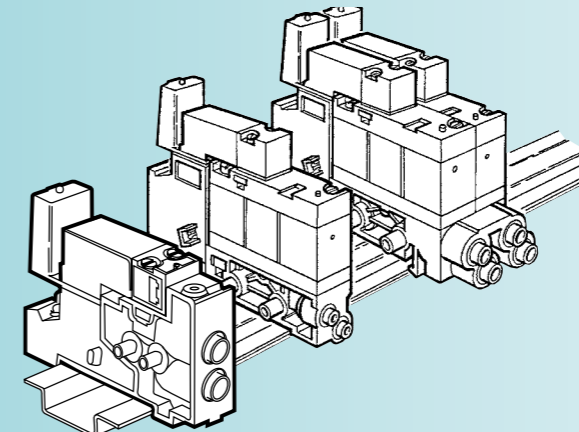

Valve modules

- › Monostable, bistable
- › 3/2, 4/2



Also available in **ATEX** version for use in potentially explosive atmospheres in accordance with 94/9/EC Directive

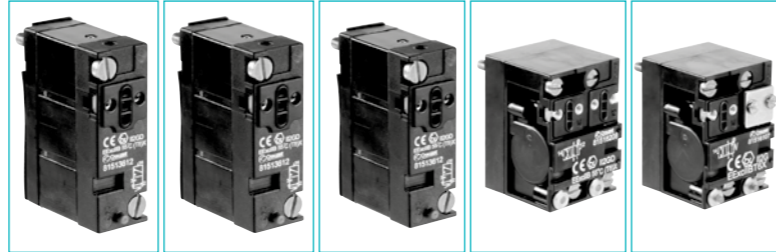

81 513 100 81 513 600 81 513 200 81 516 200 81 516 100

Function	3/2 NC monostable	3/2 NO monostable	4/2 monostable	4/2 bistable	4/2 monostable
----------	-------------------	-------------------	----------------	--------------	----------------

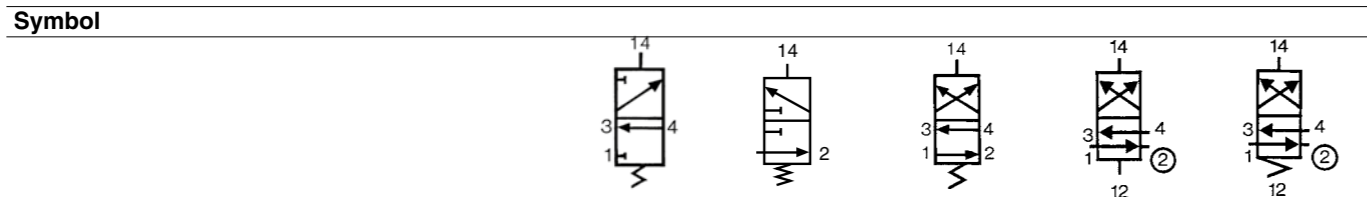

Characteristics		mm	17.5	17.5	17.5	35	35
Width	mm	17.5	17.5	17.5	35	35	
Working pressure	bars	3→8	3→8	3→8	2→8	3.5→8	
Orifice diameter	mm	3	3	3	4	4	
Flow at 6 bars	with Ø 4 mm sub-base (page 63)	200	200	200	300	300	
	with Ø 6 mm sub-base (page 63)	300	300	300	400	400	
Flow Rate	with Ø 4 mm sub-base (page 63)	2.2	2.2	2.2	4	4	
	with Ø 6 mm sub-base (page 63)	2.5	2.5	4	5	5	
Operating temperature	° C	-10 → +50	-10 → +50	-10 → +50	-10 → +50	-10 → +50	
Switching time for the valve only	ms	15	15	15	50	50	
Mechanical life	operations	1.5 x 10 ⁷	1.5 x 10 ⁷	1.5 x 10 ⁷	10 ⁷	10 ⁷	
Weight	g	38	38	38	106	106	

Dimensions

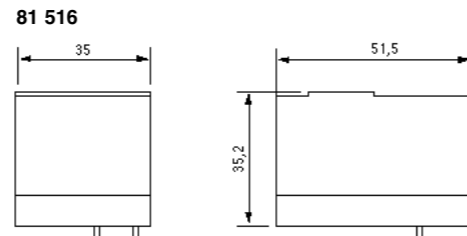
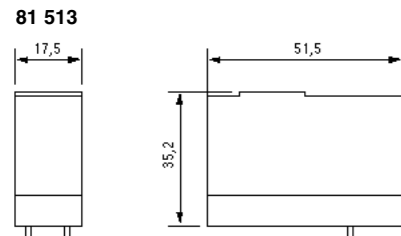

ATEX version products are available in the following catalogues: **Pneumatic products for explosive atmospheres** or on our website www.crouzet.com

Sub-bases and end bases for miniature control valves



Also available in **ATEX** version for use in potentially explosive atmospheres in accordance with 94/9/EC Directive

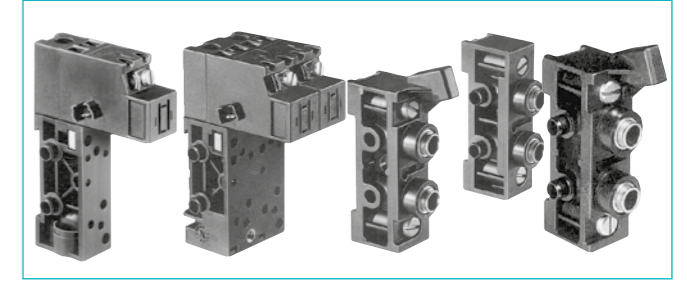

Part numbers		Cabinet	Cabinet	Cabinet	Cabinet
Mounting		17.5 mm	35 mm	—	—
Version		81 513 060	81 517 101	—	—
Push-in connection for semi-rigid tubing (NFE 49100)	Sub-bases	Ø 4 mm	81 513 065	81 517 201	—
	End bases (pair)	Ø 6 mm	—	—	81 513 011
	Intermediate supply module	Ø 6 mm	—	—	81 513 001

Characteristics		mm ²	3	3	—	—
Torque capacity		mm ²	3	3	—	—
UL and cUL approval			MM15085	MM15085	—	—
Mounting			DIN rail 35 mm	DIN rail 35 mm	DIN rail 35 mm	DIN rail 35 mm
Weight	g	55	110	86	44	

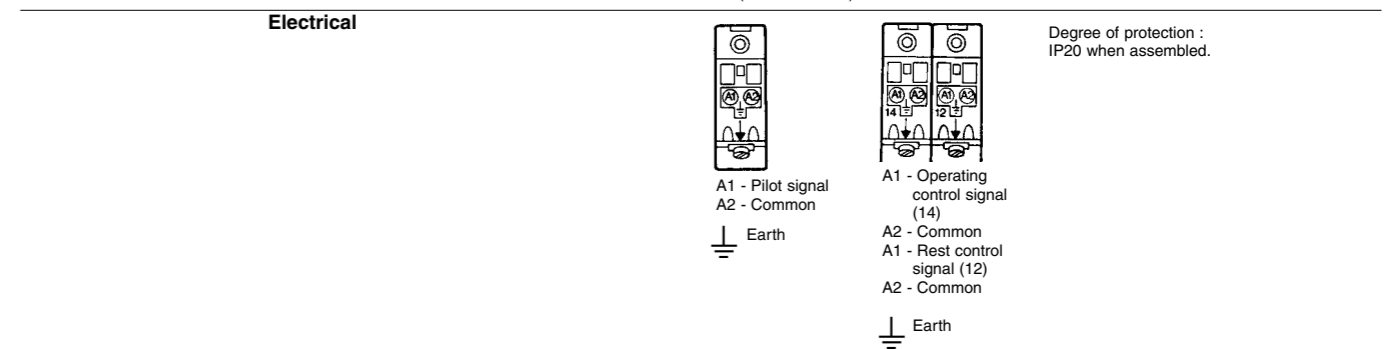
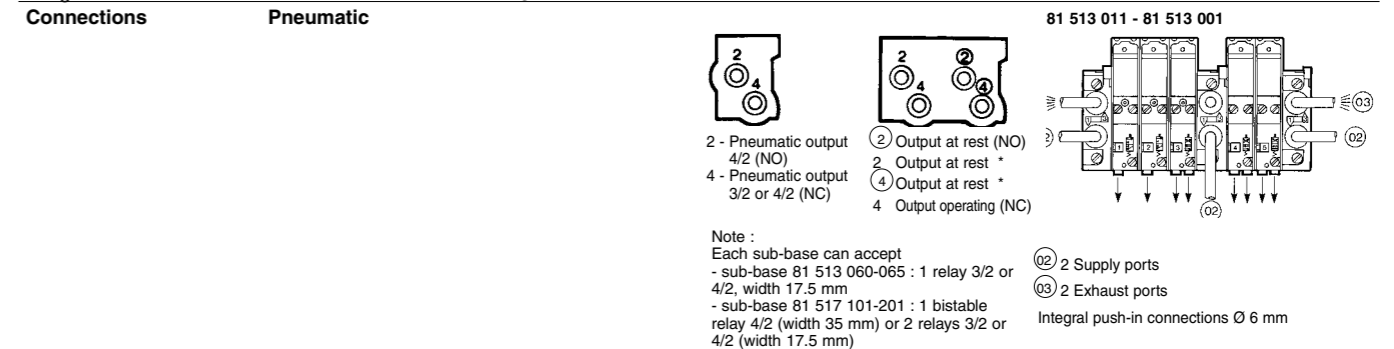

Dimensions with miniature control valves (page 62) + miniature solenoid valves (page 58) + indicators (page 65)

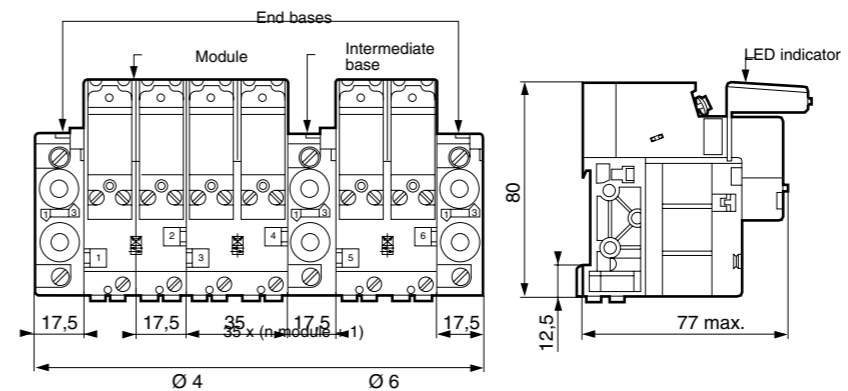

ATEX version products are available in the following catalogues: **Pneumatic products for explosive atmospheres** or on our website www.crouzet.com

Valves and solenoids valves assembled

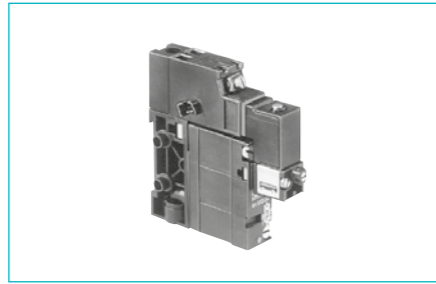

Contact us for
Other versions

Part numbers			
Function	3/2 NC	4/2 monostable	
Sub-base with push-in connection for semi-rigid tubing (NFE 49100)	Ø 4 ext.	Ø 4 ext.	
Version	Solenoid valve with manual override by impulse	Solenoid valve with manual override by impulse	
Voltage	24 VDC (+10% -15%)	81 513 103	81 513 203

Symbol



Characteristics

Operating pressure	bar	3→8	3→8
Orifice diameter	mm	3	3
Flow at 6 bars	sub-base 81 513 060 sub-base 81 517 101	NL/min 200	NL/min 200
KV	with sub-base 81 513 060 with sub-base 81 517 101	2.2	2.2
Operating temperature	°C	-10 → +50	-10 → +50
Switching time of the assembly	ms	20	20
Mechanical life (operations) at 4 bars		1.5 x 10 ⁷	1.5 x 10 ⁷
Valve position will be maintained in the event of pressure loss and/or electrical current loss		—	—
Mounting		DIN rail 35 mm	DIN rail 35 mm
Weight	g	130	130
UL and cUL approval		MH15085	MH15085

Principle of operation

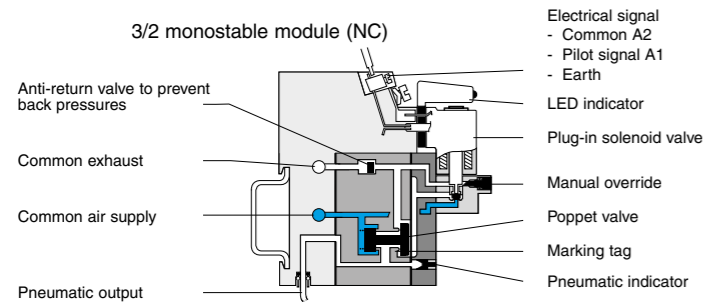

Dimensions

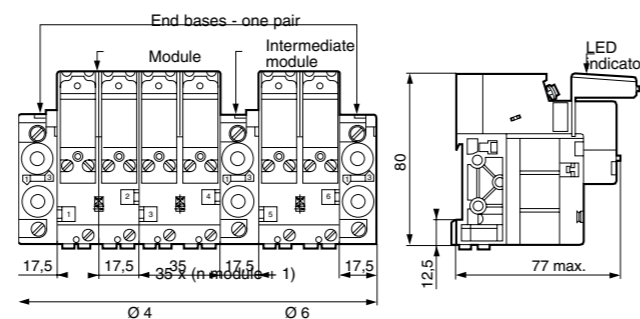

End bases not supplied (page 63)
Intermediate bases not supplied (page 63)
Indicators not supplied (page 65)

4/2 monostable module

4/2 bistable module

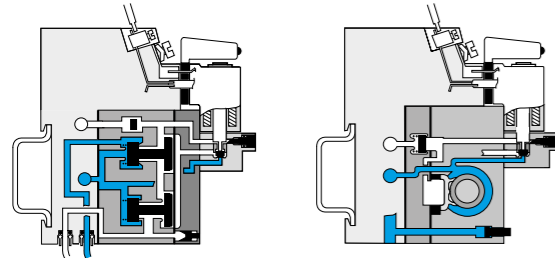

Accessories

Also available in ATEX version for use in potentially explosive atmospheres in accordance with 94/9/EC Directive

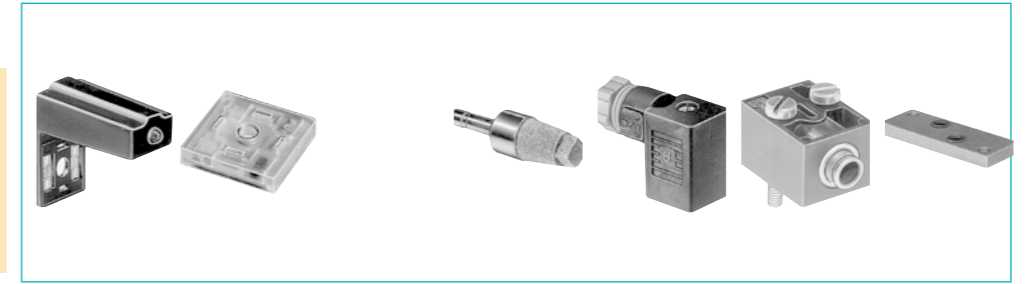

Part numbers									
Visual indicators	24 V - 50-60 Hz	81 513 052	—	—	—	—	—	—	—
with anti-surge	48 V - 50-60 Hz	81 513 055	—	—	—	—	—	—	—
	110 V - 50-60 Hz	81 513 058	—	—	—	—	—	—	—
	230 V - 50-60 Hz (-10% +6%)	81 513 059	—	—	—	—	—	—	—
LED seal	12 to 24 V - DC - AC	—	81 513 064	—	—	—	—	—	—
Packaging		(by 5)	(by 10)	—	—	—	—	—	—
Exhaust silencer	Plug-in Ø 6	—	—	81 537 001	—	—	—	—	—
	Plug-in Ø 8	—	—	81 537 201	—	—	—	—	—
Connector for solenoid valve	Without manual override	—	—	—	81 516 082	—	—	—	—
	With manual override by impulse	—	—	—	—	81 516 081	—	—	—
Pneumatic pilots	With manual override by impulse	—	—	—	—	81 516 091	—	—	—
Push-in connection for semi-rigid tubing Ø 4 mm (NFE 49100)		—	—	—	—	—	•	—	—
Blanking plate		—	—	—	—	—	—	—	81 516 085

Symbol

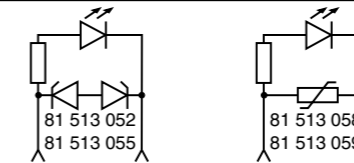

Characteristics

Consumption	W	—	0.24	—	—	—	—
Temperature	°C	—	-10 → +50	—	—	—	—
Connection	mm	—	—	—	—	Instantané Ø 4 ext.	—
Mounted between the pilot solenoid valve and the body of the module		•	•	—	—	—	—
Supplied in multiples of 5		•	—	—	—	—	—
Supplied in multiples of 10		—	•	—	—	—	—
Packet of 10 pieces		—	—	•	—	—	—
Weight	g	6	2	30	10	5	3

Connection

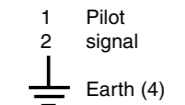

Dimensions

81 537 001 - 81 537 201

Mounted by plugging into push-in connector for semi-rigid tubing (NFE 49100)

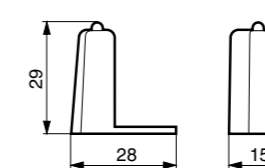
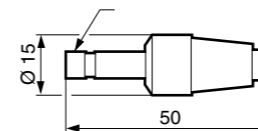

81 513 052 - 81 513 055

81 513 058 - 81 513 059

81 516 082

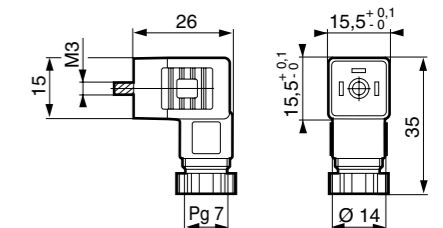

Solenoid valves

- › Reduced "dimensions"
- › Mounted on sub-base

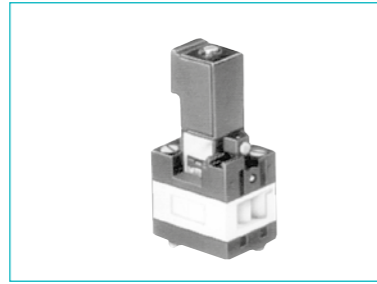

Part numbers and voltages

Function		3/2 NC
Mounting		On sub-base (54)
Solenoid valves	24 V (+10% -15%)	81 519 732
with	24 V - 50/60 Hz (+10% -15%)	81 519 774
manual	48V - 50/60 Hz (+10% -15%)	81 519 775
override	110 V - 50/60 Hz (+10% -15%)	81 519 776
by impulse	220 - 230 V - 50/60 Hz (+10% -15%)	81 519 777

Symbol

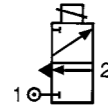

Characteristics

Operating pressure	bar	2 → 8
Orifice diameter	mm	2.7
Flow at 6 bars	Nl/min	170
Rotatable coil 4 positions in 90° steps		•
Degree of protection (with connector 81 516 082 not supplied) (see page 65)	IEC 529	IP 65
Mechanical life	operations	1.5 x 10 ⁷
Consumption	W	1
	VA	2.5
Operating temperature	°C	-5 → +50
Weight	g	70
UL and cUL approval		MH15085

Principle of operation

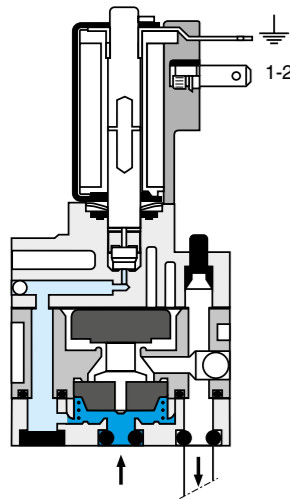

Connections

- Pneumatic { 1 - Supply
2 - Output
- Electrical { 1 - 2 - Pilot signal
Earth

Electrical connection by connector 81 516 062 (see page 65)

Dimensions 81 519

On separate sub-base

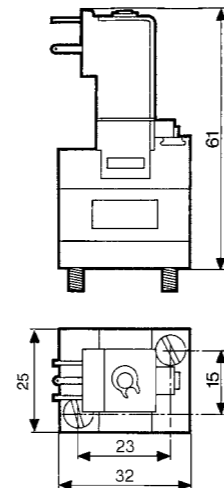

Miniature control valves, 17.5 mm

→ Electro-pneumatic interface block

Complete block, ready to install, consisting of:

- Preconfigured 8-position sub-base
- 6 4/2 monostable valve modules with 24 V[~] pilot holes
- 2 blanking plates (for extension if necessary)
- 1 connection cable



Part numbers

Part numbers	16 outputs	16 outputs
Part numbers	81513241	81513238
Electrical characteristics		
Supply voltage	24 V [~] ± -10%	24 V [~] ± -10%
Courant max. absorbé sur le 24 V de SUBD (mA)	500	500
Courant absorbé par chaque électrovanne	60	60
Response time (ms)	15	15
LED display	Yes (integrated in the sub-base)	Yes (integrated in the sub-base)
Protection against voltage surges	Yes	Yes
Electrical connections		
Type of cable	Sub D9 AWG 24 wires	Sub D9 AWG 24 wires
Cable length	2 m	2 m
Pneumatic characteristics		
Function	6 4/2 monostable valve modules (81513200) + 2 free positions	Whitout
Operating pressure bars	3 → 8 b	3 → 8 b
Flow at 6 bars NL/mim	300	300
Mechanical life (operations)	1.5 x 10 ⁷	1.5 x 10 ⁷
Working medium	Compressed air or inert gas, 50 µm filtered non-lubricated air	Compressed aire or inert gaés, 50 µm filtered non-lubricated air
Pneumatic connections		
Power supply connection	Push-in connection Ø 8 mm	Push-in connection Ø 8 mm
Output connections	Push-in connection Ø 6 mm	Push-in connection Ø 6 mm
Connection of common exhaust	Push-in connection Ø 8 mm	Push-in connection Ø 8 mm
General characteristics		
Operating temperature range IEC 68214 (°C)	-5 → +50	-5 → +50
Storage temperature IEC 68-2-14 (°C)	-15 → +50	-15 → +50
Protection (IEC/EN 60529)	IP 20	IP20
Mounting	On DIN rail or via two M5 screws (according to mounting plan)	On DIN rail or via two M5 screws (according to mounting plan)
Weight (g)	1350	960
Comments		
Other configurations on request		

Dimensions (mm)

81513241

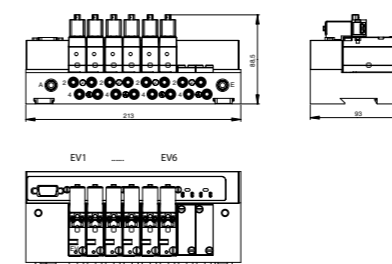

Connections

Connector wiring

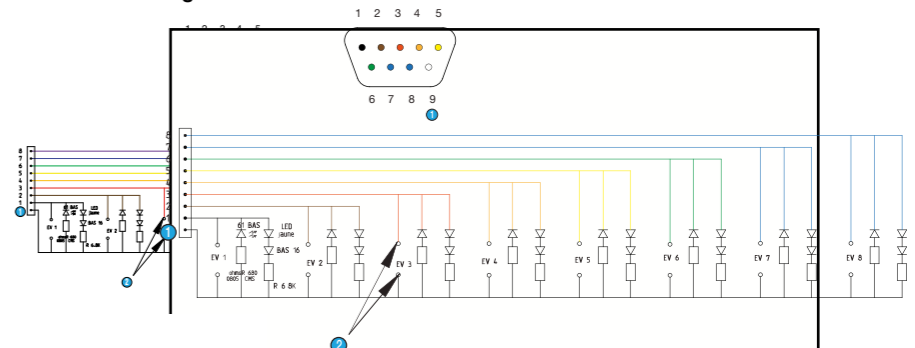

- 1 Commun 0 V
- 2 Clips femelle CI