

### Description

Single and multipole magnetic circuit breakers with trip-free mechanism and toggle actuation. A choice of fast magnetic only or hydraulically delayed switching characteristics (S-type MO or HM CBE to EN 60934) ensures suitability for a wide range of applications. Industry standard dimensions and panel mounting. Options include auxiliary changeover contacts. Low temperature sensitivity at rated load.

Approved to CBE standard EN 60934 (IEC 60934).

### Typical application

Control equipment, communications systems, transportation, power supplies.

### Standard current ratings and typical internal resistance values

Current rating (A)	Internal resistance values (Ω) per pole			
	F1	F2	K1, M1, T1	K2, M2, T2
0,02	1 493	953	2 669	2 457
0,05	276	152	452	376
0,1	58	37	100	94
0,25	8,2	6,0	15,5	14,7
0,5	2,3	1,47	3,9	3,2
0,75	0,98	0,63	1,65	1,56
1	0,58	0,35	0,95	0,90
2	0,145	0,096	0,26	0,20
2,5	0,096	0,061	0,15	0,15
3	0,065	0,048	0,10	0,10
5	0,025	< 0,02	0,042	0,040
6	< 0,02	< 0,02	0,029	0,028
8	< 0,02	< 0,02	< 0,02	< 0,02
10	< 0,02	< 0,02	< 0,02	< 0,02
12	< 0,02	< 0,02	< 0,02	< 0,02
15	< 0,02	< 0,02	< 0,02	< 0,02
16	< 0,02	< 0,02	< 0,02	< 0,02
20	< 0,02	< 0,02	< 0,02	< 0,02
25	< 0,02	< 0,02	< 0,02	< 0,02
30	< 0,02	< 0,02	< 0,02	< 0,02
40	< 0,01	-	< 0,01	-
50	< 0,01	-	< 0,01	-

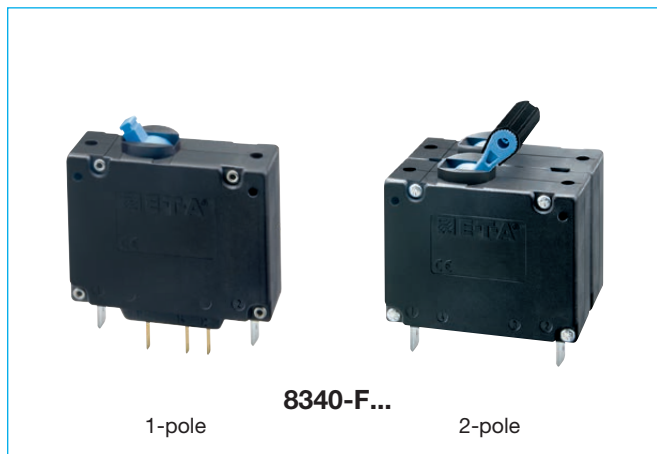

1-pole

8340-F...

2-pole

### Technical data

For further details please see: [http://www.e-t-a.de/ti\\_e](http://www.e-t-a.de/ti_e)

Voltage rating	3 AC 415 V; AC 240 V, 50/60 Hz; DC 80 V (higher DC ratings to special order)		
Current ratings	0.02...50 A DC 0.02...30 A AC		
Auxiliary circuit	6 A, AC 240 V; 3 A, DC 28 V; 1 A, DC 65 V; 0.5 A, DC 80 V		
Typical life	3 AC 415 V, AC 240 V: 0.02...30 A 6,000 operations at 1 x I <sub>N</sub> , inductive 10,000 operations at 1 x I <sub>N</sub> , resistive DC 80 V: 0.02...25 A 6,000 operations at 1 x I <sub>N</sub> , inductive 0.02...30 A 10,000 operations at 1 x I <sub>N</sub> , resistive 40 + 50 A 6,000 operations at 1 x I <sub>N</sub> , resistive		
Ambient temperature	-40...+85 °C (-40...+185 °F)		
Insulation co-ordination (IEC 60664 and 60664A)	rated impulse withstand voltage 2.5 kV reinforced insulation in operating area	pollution degree 2	
Dielectric strength (IEC 60664 and 60664A)	operating area Line to Load pole to pole (2- and 3-pole) main to auxiliary circuit switching to trip circuit (version -X)	test voltage AC 3,000 V test voltage AC 1,500 V test voltage AC 1,500 V test voltage AC 3,000 V test voltage AC 1,500 V	
Insulation resistance	> 100 MΩ (DC 500 V)		
Interrupting capacity (IEC 60934 - test sequence E)	6 x IN at AC; 4 x IN at DC		
Interrupting capacity (UL 1077)	I <sub>N</sub>	0.02...20 A	25...30 A
	AC:	1-pole AC 250 V/3,500A 2-pole AC 250 V/3,500A 3-pole 3AC 250V/3,500A	AC 250 V/3,500A AC 250 V/5,000A 3AC250V/5,000A
	DC:	1-pole 0.02...50 A 2-pole 0.02...30 A	DC 80 V/3,500 A DC 80 V/3500 A
Degree of protection (IEC 60529/DIN 40050)	operating area IP40 terminal area IP00		
Vibration	with toggle down: 10 g (57-2000Hz) ± 0.76 mm (10-57 Hz) at 0.9 x IN directions 1, 2, 3, 4, 5: 10 g (57-2000 Hz) at 1 x IN.		
Shock	100 g (11 ms) at 1 x IN, directions 1,2,3,4,5 100 g (11 ms) at 0.8 x IN, direction 6.		
Corrosion	96 hours at 5 % salt mist, to IEC 60068-2-11, test Ka		
Humidity	240 hours at 95 % RH to IEC 60068-2-78, test Cab		
Mass	approx. 65 g per pole		

**Ordering information**

<b>Type No.</b>	8340 magnetic circuit breaker with toggle actuator
<b>Mounting</b>	F flange mounting
<b>Configuration</b>	1 with mounting nuts 6-32 UNC 4 with mounting nuts M3 9 snap-in frame
<b>Number of poles</b>	1 single pole protected 2 two pole protected 3 three pole protected
	} magnetic and hydraulic magnetic delayed
<b>Panel hardware</b>	0 without panel hardware
<b>Terminal design (main contact)</b>	K4 screw terminals M5 recommended for $I_N > 20$ A P1 blade terminals A6.3-0.8 mm (QC.250) ( $\leq 35$ A)
<b>Characteristic curve *)</b>	<b>Characteristic curve, instantaneous:</b> F1 DC F2 AC 50/60 Hz <b>Short delay:</b> K1 DC K2 AC 50/60 Hz <b>Medium delay:</b> M1 DC M2 AC 50/60 Hz <b>Long delay:</b> T1 DC T2 AC 50/60 Hz
<b>Actuator colour/design</b>	A black, long toggle K black, short toggle Z black, without toggle, with slot (only 1-pole)
<b>other colours to special order</b>	
<b>Marking on actuator</b>	0 without marking L I-O; ON-OFF N I-O; ON-OFF (IN on housing top)
<b>Auxiliary contacts</b>	H0 without auxiliary contacts H1 with auxiliary contacts, gold-flushed H2 auxiliary contacts, gold-flushed on one pole only (multipole)
<b>Auxiliary contact function</b>	4 1 change over contact
<b>Auxiliary contact terminal design</b>	2 blade terminal 2.8-0.5 mm
<b>Current ratings</b>	0.02...50 A
8340 - F 1 1 0 - P1 M1 - A L H1 4 2 - 30A ordering example	

**Approvals**

Authority	Standard	Rated voltage	Current ratings
VDE	IEC / EN 60934	AC 240/415 V AC 240 V DC 80 V	0.02 A...30 A 0.02 A...30 A 0.02 A...50 A
UL	UL 1077	AC 250 V DC 80 V DC 80 V	0.02 A...30 A 0.02 A...50 A 100 A (2 poles in parallel)
CSA	C22.2 No 235	AC 250 V DC 80 V	0.02 A...30 A 0.02 A...40 A
CQC	GB 17701	AC 240/415 V AC 240 V DC 80 V	0.02 A...30 A 0.02 A...30 A 0.02 A...50 A
QPL Sweden Defence Material Admin.	MIL-C-55629	AC 240 V DC 50 V AC 240 V AC 240 / 415 V	1 A...30 A (8340-F410) 1 A...30 A (8340-410) 1 A...30 A (8340-F420) 1 A...30 A (8340-F430)

**Internal connection diagrams**

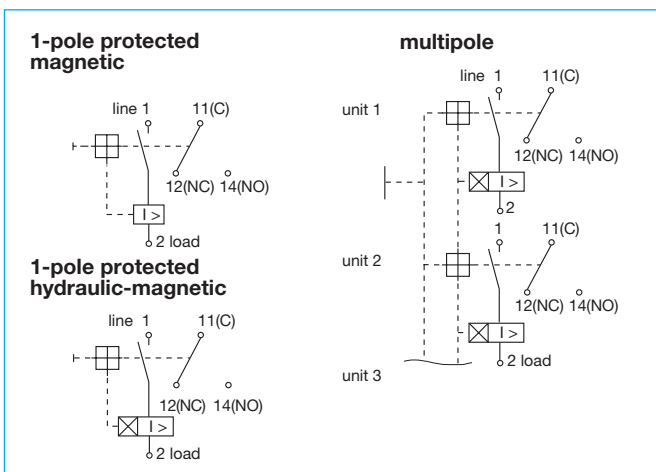

\*) Other characteristic curves upon request (e.g. pulse delayed, for high inrush currents or capacitive loads)

Please be informed that we have minimum ordering quantities to be observed.

**Preferred types**

Preferred types	Standard current ratings (A)													
	1	2	3	5	8	10	12	16	20	25	30	40	50	
8340-F410-P1K1-KNH0-	x	x	x	x	x	x	x	x	x					
8340-F410-P1K1-KNH142-	x	x	x	x	x	x	x	x	x					
8340-F410-P1M1-KNH0-	x	x	x	x	x	x	x	x	x					
8340-F410-P1M1-KNH142-	x	x	x	x	x	x	x	x	x					
8340-F410-K4K1-KNH0-										x	x	x	x	
8340-F410-K4K1-KNH142-										x	x	x	x	
8340-F410-K4M1-KNH0-										x	x	x	x	
8340-F410-K4M1-KNH142-										x	x	x	x	

**Dimensions**

**Flange mounting  
Configuration: F4**

Actuator: long toggle

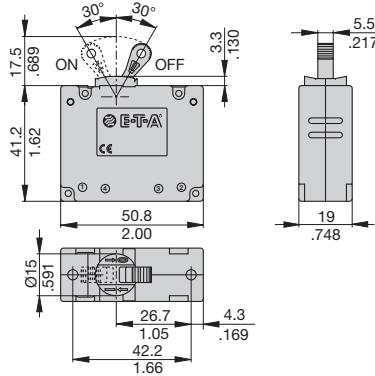

Actuator: short toggle

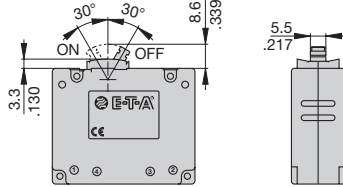

Actuator: without toggle, with slot

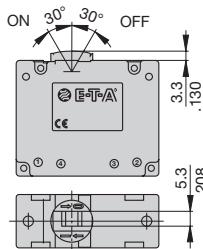

Applicable for nominal dimensions without direct tolerance indication:  
DIN ISO 286 ± IT13

number of poles: 1-3

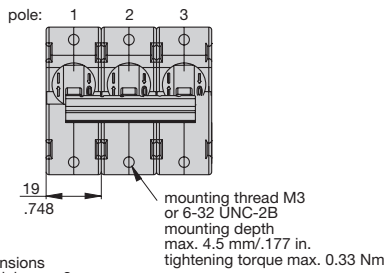

Cut-out dimensions  
max. panel thickness: 3 mm

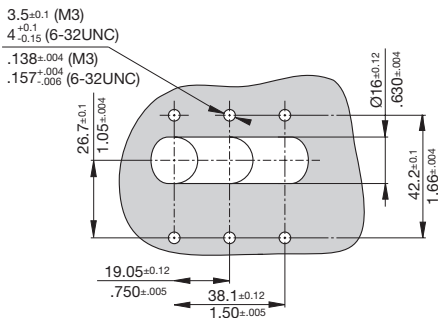

**Configuration: F9**

Actuator: long toggle

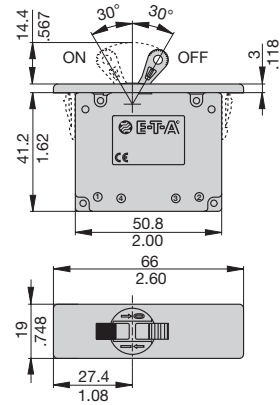

Actuator: short toggle

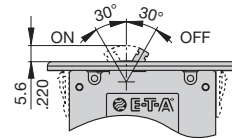

Actuator: without toggle, with slot

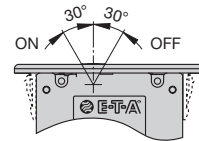

number of poles: 1-3

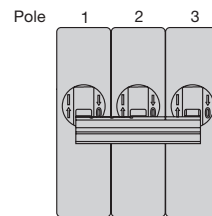

Cut-out dimensions  
max. panel thickness: 2 ± 0.1 mm or 4 ± 0.15 mm  
(snap-fit)

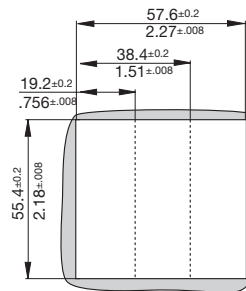

Applicable for nominal dimensions without direct tolerance indication:  
DIN ISO 286 ± IT13

This is a metric design and millimeter dimensions take precedence ( $\frac{\text{mm}}{\text{inch}}$ )

**Actuator configuration**

**Actuator design**

number of poles: 1 - 3  
Configuration: F4

**Actuator long**

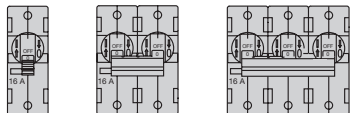

**Actuator short**

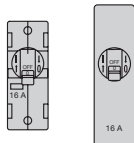

number of poles: 1 - 3  
Configuration: F9

**Actuator long**

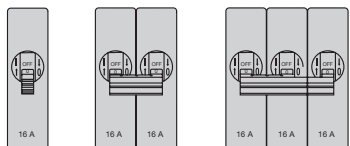

number of poles: 1  
Configuration: F4 / F9

Actuator: Z (black, without toggle, with slot)

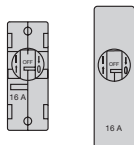

**Terminal design / Dimensions**

**K4 screw terminals M5**  
tightening torque max. 1.2 Nm

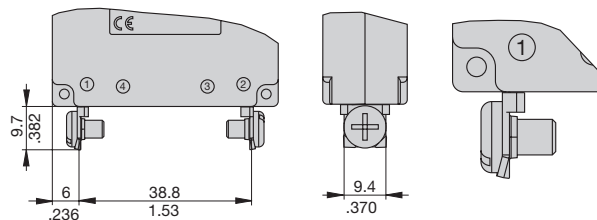

**P1 blade terminals**

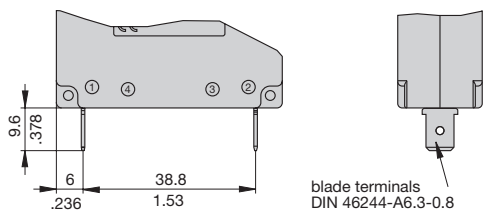

**Auxiliary contacts**

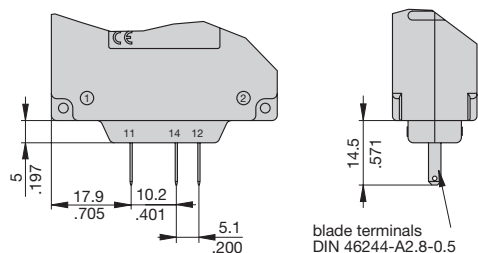

**Shock directions / Mounting attitudes**

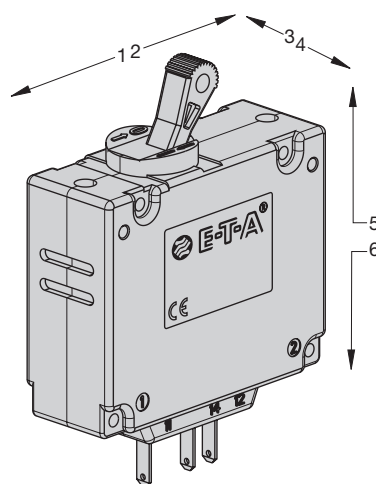

**Installation drawing**

**Terminal design K**

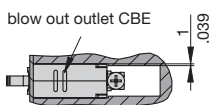

**Terminal design P**

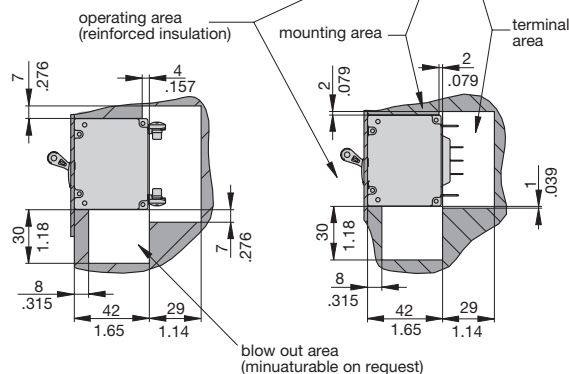
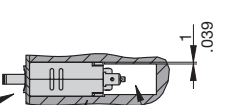

Trip time values indicated for front mounting on a vertical even surface

This is a metric design and millimeter dimensions take precedence ( $\frac{mm}{inch}$ )

1

Typical time/current characteristics at 23 °C / +73.4 °F

**Curve F1 (instantaneous) for DC**

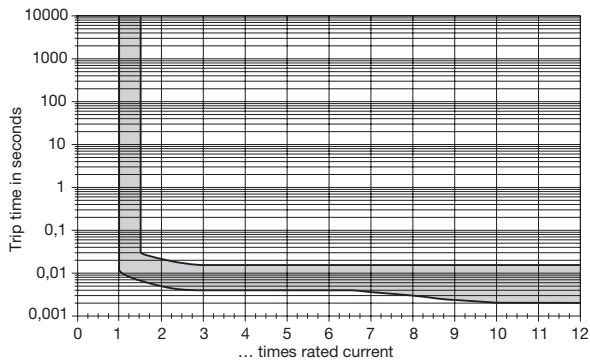

**Curve F2 (instantaneous) for AC**

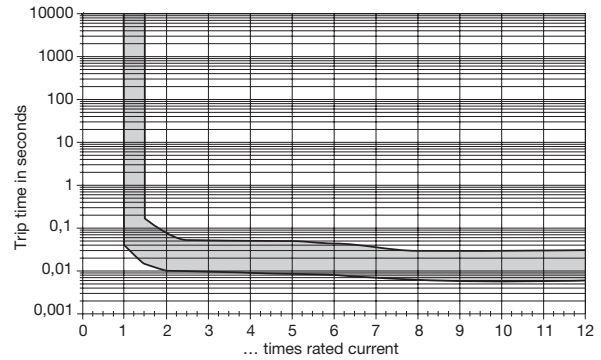

**Curve K1 (short delay) for DC**

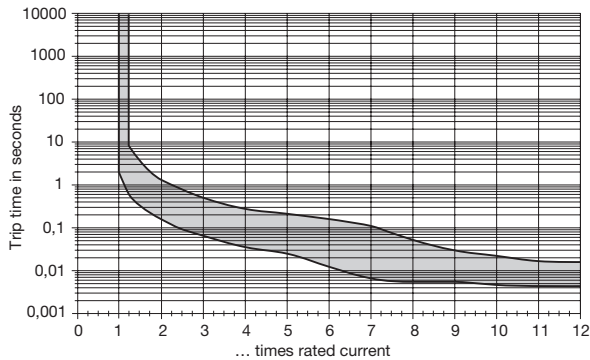

**Curve K2 (short delay) for AC 50/60 Hz**

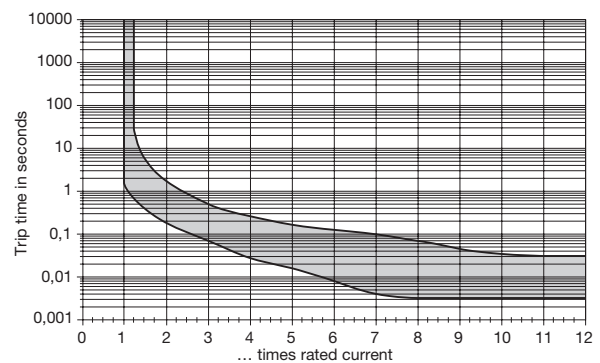

**Curve M1 (medium delay) for DC**

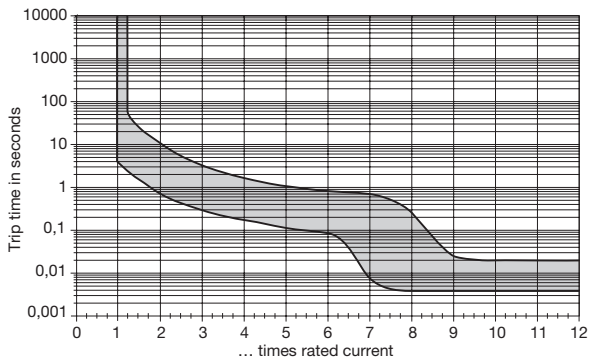

**Curve M2 (medium delay) for AC 50/60 Hz**

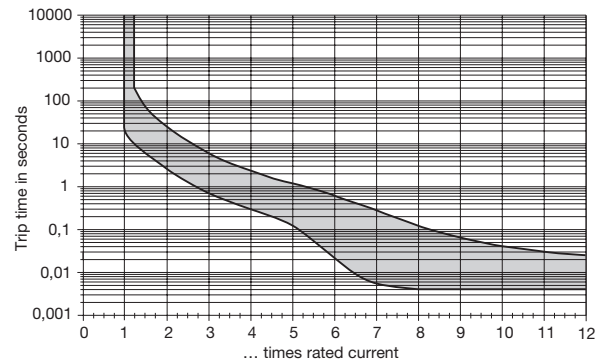

**Curve T1 (long delay) for DC**

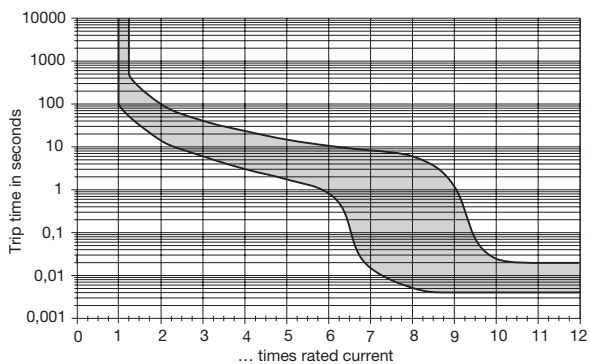

**Curve T2 (long delay) for AC 50/60 Hz**

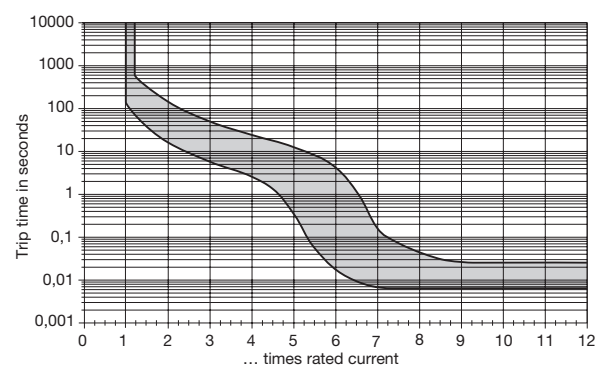

**N.B.** All curves will only be maintained if the escutcheon is mounted on a vertical surface. Ambient temperature or mounting side-by-side does not influence the trip curve, derating is not required. The breakers may trip in the event of current peaks < 0.003 sec. For these applications we offer a mechanical pulse delay – please enquire.

**Other characteristic curves upon request (e.g. pulse delayed, for high inrush currents or capacitive loads).**

1