

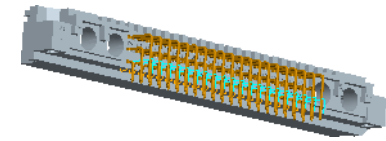

Copyright FCI.

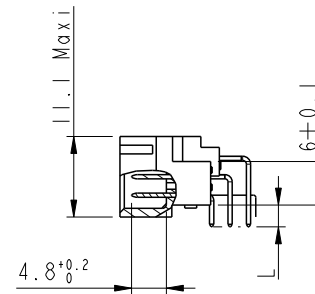

SCALE 1:1

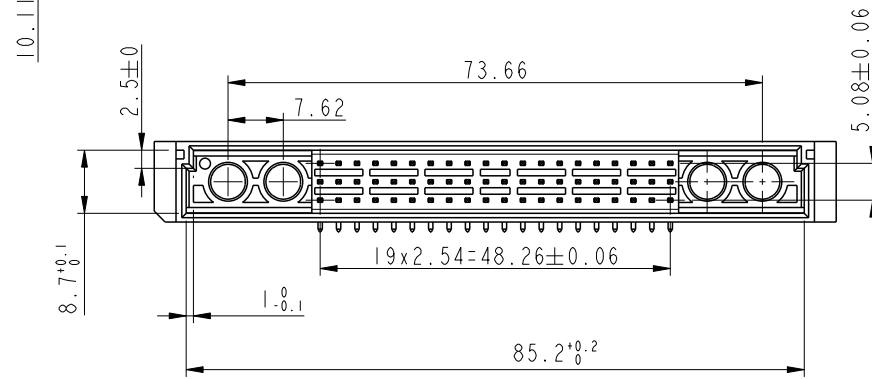
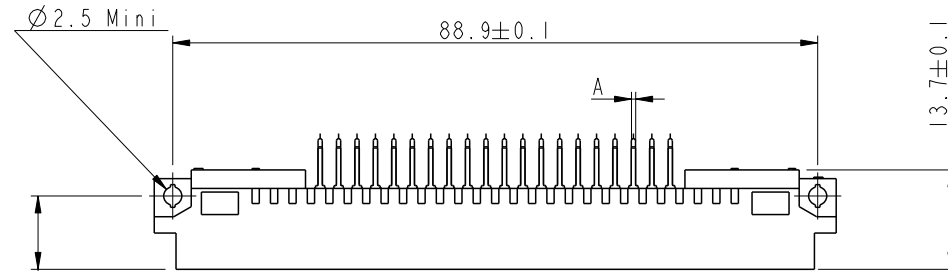
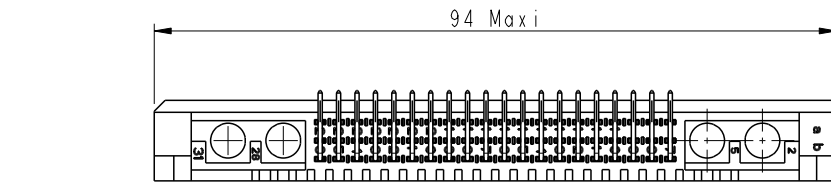
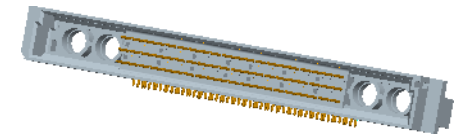

SCALE 1:1

SECTION A-A

PART-NUMBERS See Scheet 2.

GENERAL CHARACTERISTICS and ROHS INFORMATIONS
SEE DRAWING C-8609-0000A

rev	ecn no	dr	date
D	-	ROU	2002/08/30
E	LS05-001	JTA	2005/03/04
F	LS06-0097	LGO	2006/07/11
G	LS08-0169	HLE	2008/08/09
-	-	-	-
-	-	-	-

www.fciconnect.com		surface - ✓	tolerance std	projection	mm
		ISO 1302	ISO 406 ISO 1101		
		TOLERANCES UNLESS OTHERWISE SPECIFIED			
Dr	ROUILLARD	16/09/1992	ANGULAR	0.X ±0.3	size A3
Eng	J. TARON	16/09/1992	LINEAR	0.XX ±0.1	Scale 3:2
Chr	P. LEGARE	16/09/1992	0° ±2°	0.XXX ±0.05	ECN LS08-0169
Appr	P. LEGARE	16/09/1992	Product family	-	Spec ref -
	8609 SERIE STYLE M		dwg no	C-8609-0308	Rev. G
	STANDARD MALE 3 ROW				
	catalog no 8609 xxx xl 13x 7x5 EILF		CUSTOMER		sheet 1 of 2

REV I - 2006-04-17

PART NUMBER		8609		C I		5	
PIN OUT		rows a-b-c		3		60	
		rows a-c		4		40	
NUMBER OF CONTACTS							
TERMINATION		L = 2.75 ± 0.15 (.108)		A = ∅0.6 ⁰ _{-0.08}		B = ∅0.8 ⁰ _{+0.3}	
		L = 4.15 ± 0.15 (.163)		A = 0.6x0.6		B = ∅1 ± 0.1	
no option		-----		7			
with harpoons		----- for PCB thickness 1.6 mm -----		H			
DIN 41612 class 3		-----		4			
DIN 41612 class 2		-----		5			
DIN 41612 class 1		-----		6			
TERMINATION TYPE		-----		000E1			
TIN LEAD		-----		E1LF			
LEAD FREE		-----					

PCB DRILLING
Component side

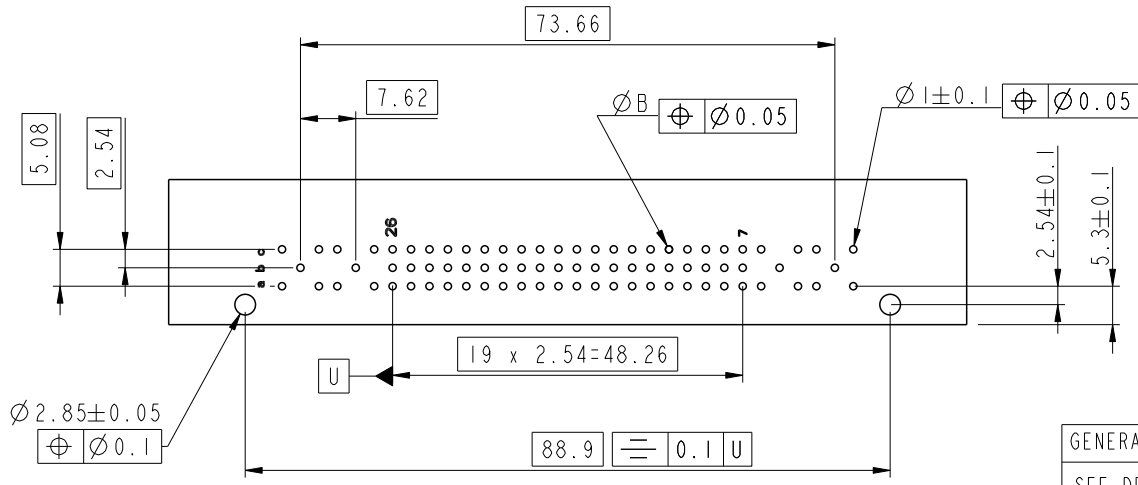

GENERAL CHARACTERISTICS AND ROHS INFORMATIONS:
SEE DRAWING C-8609-0000A

European Views

www.fciconnect.com			surface -	tolerance std	projection	mm
			ISO 1302	ISO 406 ISO 1101		
			TOLERANCES UNLESS OTHERWISE SPECIFIED			
Dr	ROUILLARD	16/09/1992	ANGULAR	LINEAR	0.X ± 0.3	size A3
Eng	J. TARON	16/09/1992			0.XX ± 0.1	Scale 3:2
Chr	P. LEGARE	16/09/1992	0° ± 2°		0.XXX ± 0.05	ECN LS08-0169
Appr	P. LEGARE	16/09/1992	Product family		- Spec ref -	
	title 8609 SERIE STYLE M				dwg no	Rev.
	STANDARD MALE 3 ROW				C-8609-0308	G
	catalog no 8609 xxx xl 13x 7x5 E1LF			CUSTOMER	sheet 2 of 2	

Copyright FCI