

Specifications for "F" Connectors

F style connectors are the least expensive, general purpose connectors with non-constant impedance for use at 500 volts or less, and for use with low frequencies to 500Mhz. These coaxial connectors are widely used in Cable TV, MATV, CCTV, and related consumer television products. They are available in a limited selection to fit various cables sizes.

MATERIALS	
Connector Parts	Material
Connector Body and Parts	Brass
Male Contact Pin	Brass
Insulators.	Polypropylene
Plating	Nickel
Ferrule	Annealed Copper

ELECTRICAL	
Requirement	Performance
Impedance	Non Constant
Frequency Range	0-500MHz
VSWR	1.5 Max.
Working Voltage (At Sea level)	500V rms
Insulation Resistance	5000 Megohm Min.
Contact Resistance	3 mΩ Max.
Test Voltage	1000V r.m.s.

MECHANICAL & ENVIRONMENTAL	
Requirement	Performance
Durability	500 Matings
Shock	30 G
Cable Retention	40 Lbs. Min.
Temperature Range	-40 to +65°C.
Moisture Range	Continuous Test

"F" Connectors

Plugs, Jacks, Adapters

F type plugs are available in three different crimp styles: two piece with separate ferrules, one piece crimp with a short crimp body and a one piece crimp with a long body. Also, a twist-on type for tool-less installations. Jacks for bulkhead, inline, or PC board, and a variety of adapters are all machined brass construction.

Part Number	Description	RG/U Cable No.	Fig.																							
810A209A	2 Piece Crimp Plug, Short Ferrule	6	117																							
810A209D	2 Piece Crimp Plug, Short Ferrule	11	117																							
810A209G	2 Piece Crimp Plug, Short Ferrule	59	117																							
810B209G	2 Piece Crimp Plug, Long Ferrule	59	118																							
810D209A	1 Piece Crimp Plug, Short Ferrule	6	119																							
810A209MV	4 Pc Crimp Mini Coax. Uses BD11007 Tool	174	117A																							
810D209D	1 Piece Crimp Plug, Short Ferrule	11	119																							
810D209G	1 Piece Crimp Plug, Short Ferrule	59	119																							
810E209A	1 Piece Crimp Plug, Long Ferrule	6	120																							
810E209D	1 Piece Crimp Plug, Long Ferrule	11	120																							
810E209G	1 Piece Crimp Plug, Long Ferrule	59	120																							
810A409A	Twist-On	6	121																							
810A409G	Twist-On	59	121																							
810P209A	Push-On	6	122																							
810P209G	Push-On	59	122																							
810PE209A	Push-EZ™ Plug with LIFT® Technology	6	126A																							
810PE209G	Push-EZ™ Plug with LIFT® Technology	59	126A																							
816B519	Male Bulkhead Receptacle, 3/8-32 THD I.D.	Any	130A																							
826B519	Bulkhead Jack, Solder Tab	Any	123																							
832A519N	Inline Female/Female W/No. & Washer	N/A	124																							
830A509	Inline, Male/Male	N/A	125																							
831B509	Inline Female/Male Push-On	N/A	125A																							
832A519	Inline Female/Female	N/A	126																							
843A509	"T" Adapter, Female/Male/Female	N/A	127																							
845A509	"T" Adapter, Female/Female/Female	N/A </tr <tr> <td>851A509</td> <td>Right Angle Adapter, Male/Female</td> <td>N/A</td> <td>129</td> </tr> <tr> <td>F0884</td> <td>75 Ohm Male Terminator</td> <td>N/A</td> <td>130</td> </tr> <tr> <td>861A509</td> <td>PC Board Jack, Vertical</td> <td>N/A</td> <td>131</td> </tr> <tr> <td>861V509E</td> <td>V-Bite™ Edge Mount PC Jack</td> <td>N/A</td> <td>134V</td> </tr> <tr> <td>861V509R</td> <td>V-Bite™ Reflow Type w/TFE Insulator</td> <td>N/A</td> <td>134V</td> </tr> <tr> <td>864B509</td> <td>PC Board Jack, Right Angle, Long</td> <td>N/A</td> <td>132</td> </tr>	851A509	Right Angle Adapter, Male/Female	N/A	129	F0884	75 Ohm Male Terminator	N/A	130	861A509	PC Board Jack, Vertical	N/A	131	861V509E	V-Bite™ Edge Mount PC Jack	N/A	134V	861V509R	V-Bite™ Reflow Type w/TFE Insulator	N/A	134V	864B509	PC Board Jack, Right Angle, Long	N/A	132
851A509	Right Angle Adapter, Male/Female	N/A	129																							
F0884	75 Ohm Male Terminator	N/A	130																							
861A509	PC Board Jack, Vertical	N/A	131																							
861V509E	V-Bite™ Edge Mount PC Jack	N/A	134V																							
861V509R	V-Bite™ Reflow Type w/TFE Insulator	N/A	134V																							
864B509	PC Board Jack, Right Angle, Long	N/A	132																							

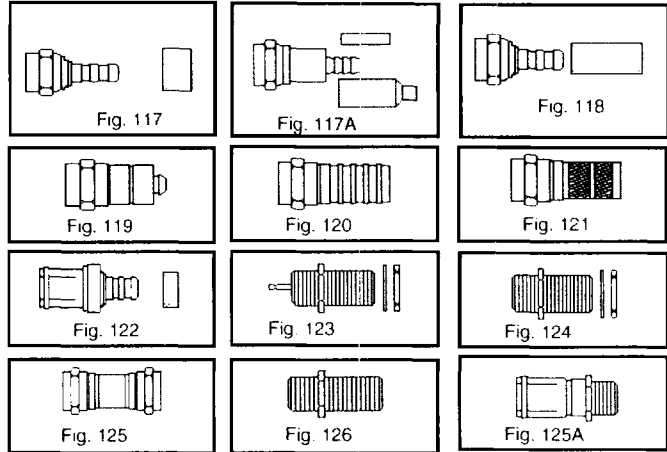

New! LIFT® Technology (Low Insertion Force Termination)

Fig. 126A

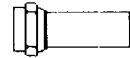

40 lb. Retention.

The Push-EZ™ connector installs by simply stripping the cable and inserting it into the connector. That's it.

Patented

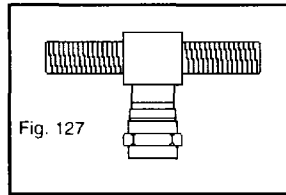

Fig. 127

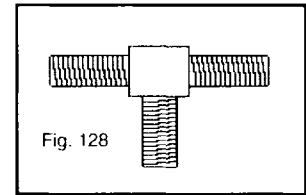

Fig. 128

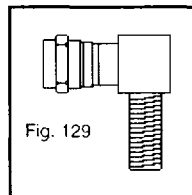

Fig. 129

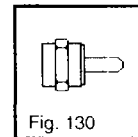

Fig. 130

This new item acts as a jack & allows for a replaceable female end by using a 832A519 adapter.

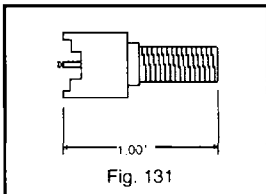

Fig. 131

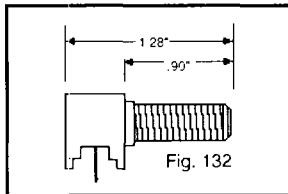

Fig. 132

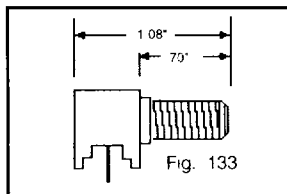

Fig. 133

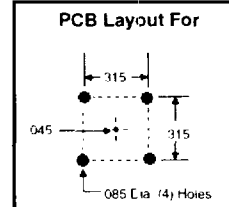

Fig. 130A

3/8"-32 Internal Thd.
1/2" External Thd.

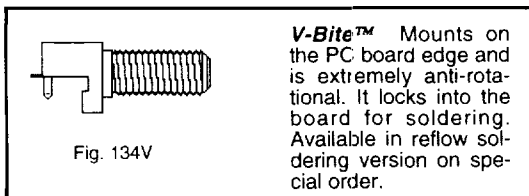

Fig. 134V

V-Bite™ Mounts on the PC board edge and is extremely anti-rotational. It locks into the board for soldering. Available in reflow soldering version on special order.

