



SOURIAU

ARINC 600 Series

Rack & Panel Rectangular Connectors

ARINC 600 Series



Contents

Overview

• Benefits	06
• Applications	06
• Technical characteristics	07
• How to built an ARINC	08
• Connector part number	09
• Inserts layout:	
Shell size 1	10
Shell size 2 & 3	10
• Cavity overview	13
• Cost Effective ARINC	14

Mechanics

• Sealing level & plating	18
• Grounding	18
• Shell size & shell type	19
• Contact mounting & release	22
• Mounting style	22
• Inserts arrangement code:	
Power insert - cavities C & F	23
Signal insert - cavities A, B, D & E	24
• Polarization	25
• Packaging	27

Contacts & Tooling

• Crimp contacts	30
• PC tail contacts	34
• Wire wrap contacts	35
• Twinax contacts	35
• Triax contacts	36
• Quadrax contacts	36
• Cavity reducers	36
• ELIO® fiber optic contacts/adaptor #8	37
• Filler plug	38
• Dummy contacts	38
• Dummy inserts	38
• Crimping tools	39
• Insertion & extraction of the contacts	40
• Insertion & extraction tools	41
• Accessories: Covers	41

Range Extension

• Custom product	44
• <i>microComp</i> ® Series	44
• D-Subminiature Series	45
• NAFI 1 & 2	45

ARINC 600



ARINC 600 Series

Overview

■ Benefits	06
■ Applications	06
■ Technical characteristics	07
■ How to built an ARINC	08
■ Connector part number	09
■ Inserts layout:	
Shell Size 1	10
Shell Size 2 & 3	10
■ Cavity overview	13
■ Cost Effective ARINC	14

ARINC 600 Series

Benefits

Rackable solution

- ▶ Up to 800 #22 signal contacts
- ▶ Up to 56 #8 quadrax contacts

Modular solution

- ▶ Build your own connector matching your exact needs

Repairable solution

- ▶ EMI RFI shielding solution
- ▶ Nickel and alodine plating
- ▶ 100A power capability
- ▶ Fixing type
- ▶ Grounding
- ▶ Filtering

High density solution

- ▶ Blind mate, Clearance device for better rackability
- ▶ Low insertion force

Configurable solution

- ▶ Wide range of insulators and type of contacts: signal, power, coax, triax, twinax, ELIO® fiber optic

Many options available

- ▶ Front and rear release removable contacts, flex circuit integration and cabling

Applications

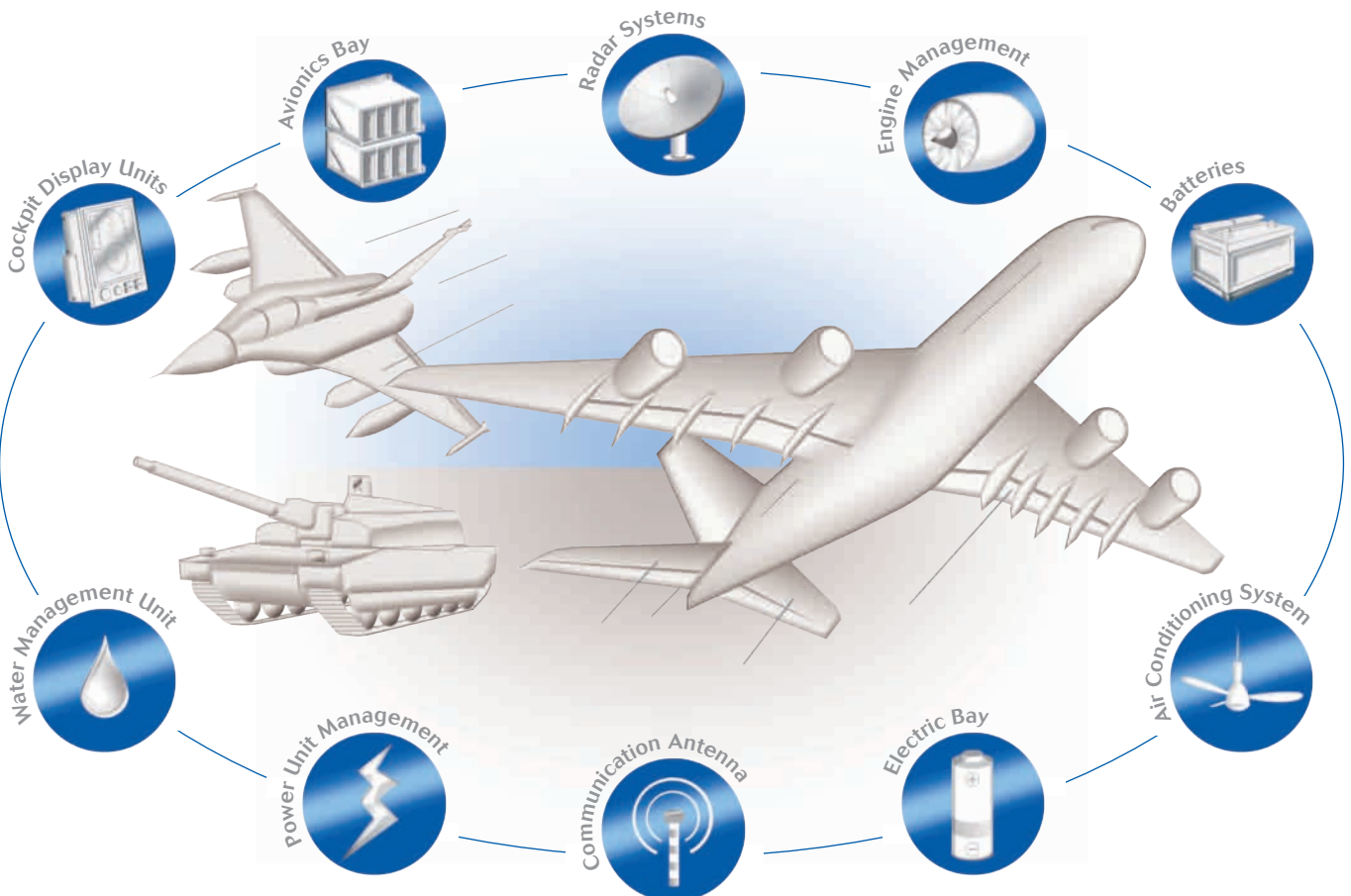

ARINC 600 Series



Description

- High performance avionic equipment rectangular connectors compliant to ARINC 600 specifications
- Rack and panel connector
- High density up to 800 signal contacts
- Low insertion force contact design (tapered pin, LIF socket)
- Sealed and unsealed versions
- Multiple polarizing positions
- Field replaceable inserts, featuring .006 in true position of contact cavities
- Choice of front and rear removable contacts
- Contacts : signal, power, coaxial, triaxial, filter, optical fiber and waveguide connection contacts
- Wide range of high performance rack applications

Technical features

Mechanical

	Material	Plating
Shells	Aluminum alloy to QQ-A-591	Alodine 1200 passivation to MIL-C 5541 class 1
		Nickel plating
Insulator	Epoxy resin thermoset	
	Thermoplastic	
Seals and grommets	Fluorinated silicon compliant to MIL-R-25988	
Contacts	Copper alloy to QQ-B-626	Gold plated compliant to MIL-G-45204 over nickel to QQ-N-290

- Endurance: 500 matings
- Insertion and extraction forces max:
 - . Shell size 1: 120N (27 lbs)
 - . Shell size 2: 267N (60 lbs)
 - . Shell size 3: 467N (105 lbs)
- Vibration: 8 hours in each axis.
Random vibration at 16.4 g Rms from 50 to 2000 Hz
MIL-STD-1344 A method 2005-1
- Dynamic shock: 3 impacts of 50 g in all axis, duration 11 μs (half wave) to MIL-STD-202 method 213

Electrical

- Dielectric withstanding voltage

	Mated	Unmated
Sea level	1 500 Vrms	1 500 Vrms
15 000 m	500 Vrms	500 Vrms

- Voltage rating:
 - . 500 Vac Max
 - . 125 Vac at 21 000 m
- Insulation resistance: $\geq 5000 \text{ M}\Omega$
- Current ratings, continuous:

Contact	Wire gauge	Current (A)	Voltage drop max (mV)*
22	22	5	40
	24	3	30
	26	2	25
20	20	7,5	55
	22	3	40
	24	5	30
16	16	13	50
12	12	23	45

* measured over a conductor length of 150 mm

- Quadrax contact size 8
Contact resistance (low level): initial 15 MΩ, after tests 30 MΩ
Voltage rating:
 - . 500 Vac max
 - . 125 Vac at 21 000 m
- Insulation resistance:
 - . at ambient temperature $> 5000 \text{ M}\Omega$
 - . at high temperature $> 1000 \text{ M}\Omega$
- Characteristic impedance: 100Ω at 100MHz
Attenuation $< 0.3 \text{ dB}$ at 100 MHz typical per contact pair
Contact to shell continuity $< 10 \text{ M}\Omega$

- Triaxial contact size 8
Bandwidth: 0-20 MHz
Voltage rating:
 - . 500 Vac max
 - . 125 Vac at 21 000 m
- Voltage drop:
 - . Inner & middle contact $\leq 55 \text{ mV}$ under 1A
 - . Outer contact $\leq 75 \text{ mV}$ under 12A

Optical ELIO® Contact

- ARINC 600 connector can integrate ELIO® fiber optic contacts in #8 quadrax cavities with the addition of ELIO® #8 adaptor

- Insertion loss: 0.3 dB per contact

- Possibility to mix optical and electrical signals in the same insert

- Flight proven at temperature range $-65^\circ\text{C} + 125^\circ\text{C}$

- Designed to comply with ELIO® contact optical performances

Climatic

- Temperature rating: -65°C to $+125^\circ\text{C}$ for both classes, sealed and unsealed

- Fluid resistance:
 - . Hydraulic to MIL-H 5606
 - . Lubricating to MIL-L 23699
 - . Isopropyl alcohol

- Resistance to salt spray: 48 hours (MIL-STD-202 method 101 or MIL-STD-1344 method 1001)

- Sealing: Environment resistant (sealed version)

ARINC 600 Series

How to Built an ARINC ?

For a new project:
Gather all informations !

SB6



1



Sealing level & plating

2



Shell size

F



Shell type

K



Contact mounting & release

13



Mounting style

W2



Power insert

S



Contact type

00



Signal insert

01



Polarization code

UD



Packaging code

SB612FK13W2S0000UD

=
Your connector

Match perfectly your
Box connection needs

Packaging code not mandatory.
For any information, please consult us:
contactmilaero@souriau.com

ARINC 600 Series

Connector Part Number

Basic Series	SB6	1	2	F	K	13	W2	S	00	01	UD												
Sealing Level & Plating 0: Sealed (alodine plated) 1: Unsealed (alodine plated) <i>More information & other configuration: see page 18</i>																							
Shell Size 1-2-3 <i>Drawings and panel cut out: see pages 19 to 21</i>																							
Shell Type F: Equipment receptacle M: Rack plug <i>More information: see page 13. Drawings: see pages 19 to 21</i>																							
Contact Mounting & Release G: Rear release signal and power contacts H: Front release signal contacts (PC Tail and wire wrap terminations for receptacle) and rear release power contacts J: Mix of front and rear release contacts (consult us) K: Front release signal contacts (PC Tail and wire wrap terminations for receptacle) and power contacts X: Non removable contacts for insert 100 and/or 150 points. Other contacts are front release (only for receptacles) Y: Non removable signal contact for insert 100 and 150 points. Front release for other signal contacts. Rear release for power contacts (only for receptacles) Z: Mix of non-removable contact for insert 100 and 150 points, and front and rear release contacts (only for receptacles) - consult us <i>More information: see page 22</i>																							
Mounting Style <i>More information and coding: see page 20</i>																							
Inserts Arrangement Code - Power Insert (2 digits) Cavities C and F <i>Insert range: see page 10. Coding: see page 23</i>																							
Contact Type P: Male signal contact #22 (rack plug) S: Female signal contact #22 (equipment receptacle) <table border="1" data-bbox="142 1352 818 1465"> <tr> <td></td> <td>M: rack plug</td> <td>F: equipment receptacle</td> </tr> <tr> <td>Signal contacts</td> <td>Pin (male)</td> <td>Socket (female)</td> </tr> <tr> <td>Power contacts</td> <td>Socket (female)</td> <td>Pin (male)</td> </tr> <tr> <td>Quadrax, coaxial and triaxial contacts</td> <td>female</td> <td>male</td> </tr> </table>													M: rack plug	F: equipment receptacle	Signal contacts	Pin (male)	Socket (female)	Power contacts	Socket (female)	Pin (male)	Quadrax, coaxial and triaxial contacts	female	male
	M: rack plug	F: equipment receptacle																					
Signal contacts	Pin (male)	Socket (female)																					
Power contacts	Socket (female)	Pin (male)																					
Quadrax, coaxial and triaxial contacts	female	male																					
<i>More information: see pages 30 to 36</i>																							
Inserts Arrangement Code - Signal Insert (2 digits) Cavities A, B, D and E <i>Insert range: see pages 10 and 11. Coding: see page 24</i>																							
Polarization Code 00: Rack plug = polarizing key delivered unmounted Equipment receptacle = polarizing eyes delivered unmounted 01 to M6: Rack plug = location of polarizing key delivered mounted Equipment receptacle = location of polarizing eyes delivered mounted <i>Coding: see pages 25 and 26</i>																							
Packaging Code 1st letter: signal and power contacts 2nd letter: twinax, triax, coaxial and quadrax contacts <i>Coding: see page 27</i>																							

For any other requirement, please consult us.

ARINC 600 Series

Inserts Layout

Contact type:

S Signal
 P Power
 C Coax
 T Triax
 Q Quadrax or Twinax
 E ELIO® Fiber Optic

Shell Size 1

Cavity A & B

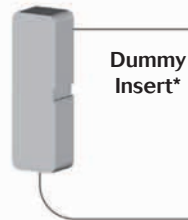
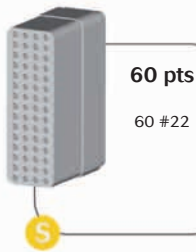

Cavity C

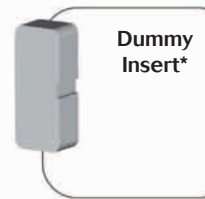
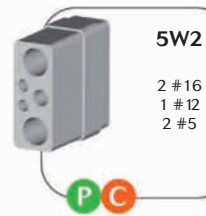
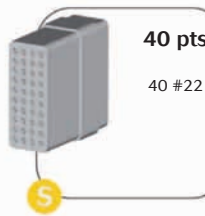

Shell Size 2 & 3

Cavity C & F

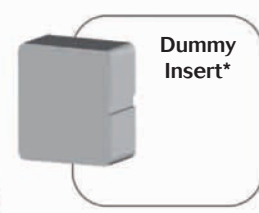
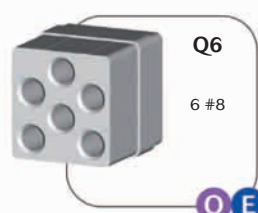
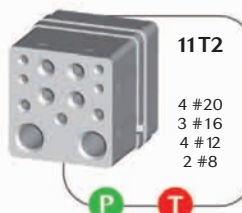
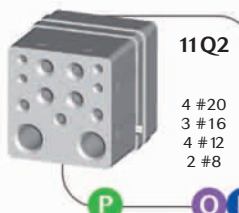
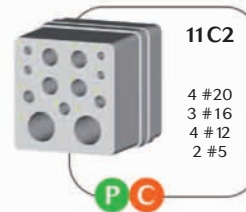
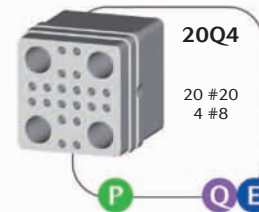
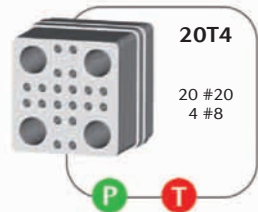
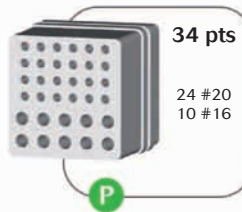
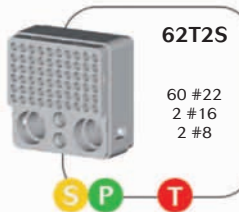
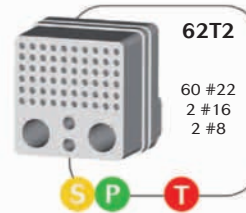
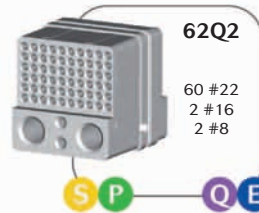
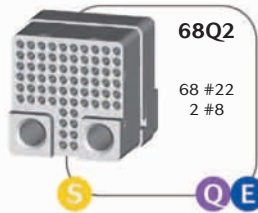
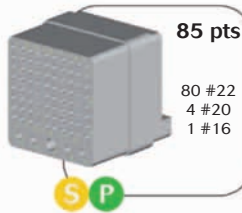
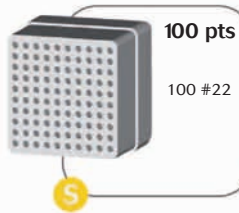

* See table page 38

ARINC 600 Series

Inserts Layout

Contact type:

S Signal
 P Power
 C Coax
 T Triax
 Q Quadrax or Twinax
 E ELIO® Fiber Optic

Shell Size 2 & 3

Cavity A, B, D & E

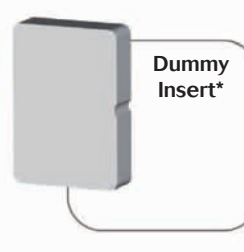
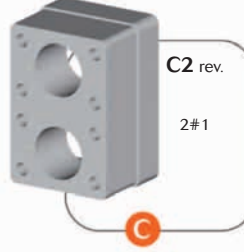
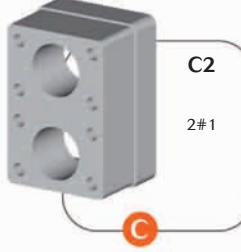
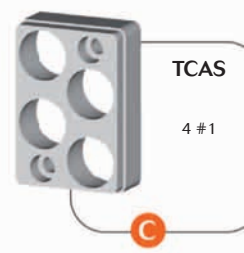
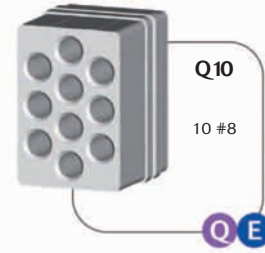
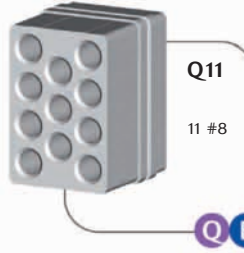
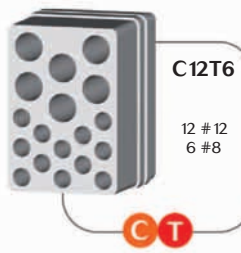
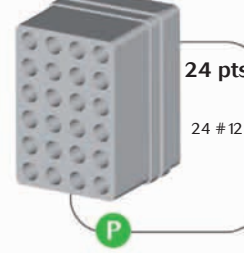
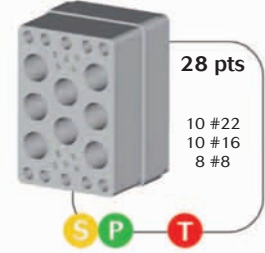
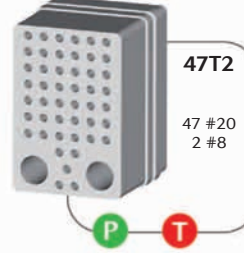
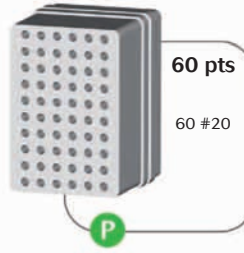
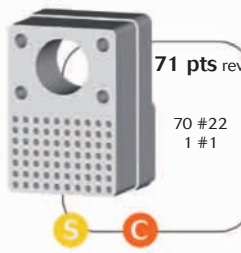
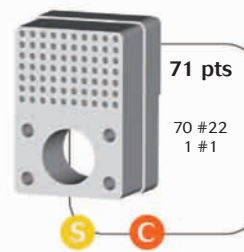
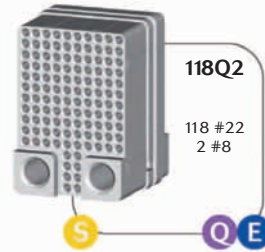
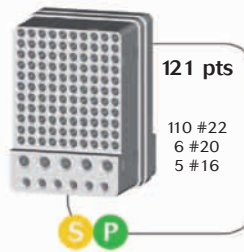
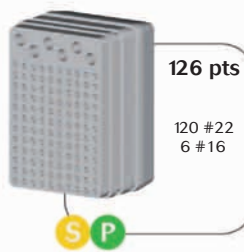
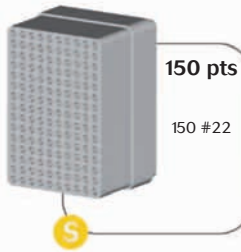

* See table page 38

ARINC 600 Series

Inserts Layout

S Signal
 P Power
 C Coax
 T Triax
 Q Quadrax
 E ELIO® Fiber Optic

Insert	Shell size	Cavity	Contacts type	Number of cavities						
				#22	#20	#16	#12	#8	#5	#1
60 pts	1	A, B	S	60						
40 pts		C	S	40						
5W2			P C			2	1		2	
150 pts	2 & 3	A, B, D, E	S	150						
126 pts			S P	120		6				
121 pts			S P	110	6	5				
118Q2			S Q	118				2		
71 pts			S C	70						1
71 pts rev.			S C	70						1
60 pts			P			60				
47T2			P T			47			2	
28 pts ⁽¹⁾			S P T	10		10			8	
24 pts			P					24		
C12T6			C T					12	6	
Q11			Q						11	
Q11 mixte ⁽²⁾			Q						11	
Q10			Q						10	
TCAS		C							4	
C2		C							2	
C2 rev.		C							2	
100 pts		C, F	S	100						
85 pts ⁽³⁾			S P	80	4	1				
68Q2			S Q	68				2		
62Q2			S P Q	60			2		2	
62T2			S P T	60			2		2	
62T2S mixte ⁽⁴⁾			S P T	60			2		2	
34 pts			P			24	10			
20T4			P T			20			4	
20Q4			P Q			20			4	
11C2			P C		4	3		4		2
11Q2			P Q		4	3		4	2	
11T2	P T			4	3		4	2		
Q6	Q							6		
T6	T							6		

⁽¹⁾ Triax #8 & #16 cavities (859) specifics

⁽³⁾ #20 and #16 always rear release

⁽²⁾ 5 rear & 6 front or 6 rear & 5 front

⁽⁴⁾ Triax rear and other contacts front release

Version for quadrax #8 cavity and ELIO® #8 adaptor

Insert name	Shell size	Cavity	Contacts type	Number of cavities						
				#22	#20	#16	#12	Quadrax #8 or Optical way	#5	#1
118Q2	2 & 3	A, B, D, E	S Q E	118				2		
Q11			Q E				11			
Q10			Q E				10			
68Q2		C, F	S Q E	68				2		
62Q2			S P Q E	60		2		2		
20Q4			P Q E			20			4	
11Q2			P Q E		4	3		4	2	
Q6			Q E						6	

ARINC 600 Series

Cavity Overview

Shell Size 1

- ▶ 2 cavities "A & B" for Signal inserts (see page10)
- ▶ 1 cavity "C" for Power inserts (see page10)
- ▶ See page17 for shells dimensions

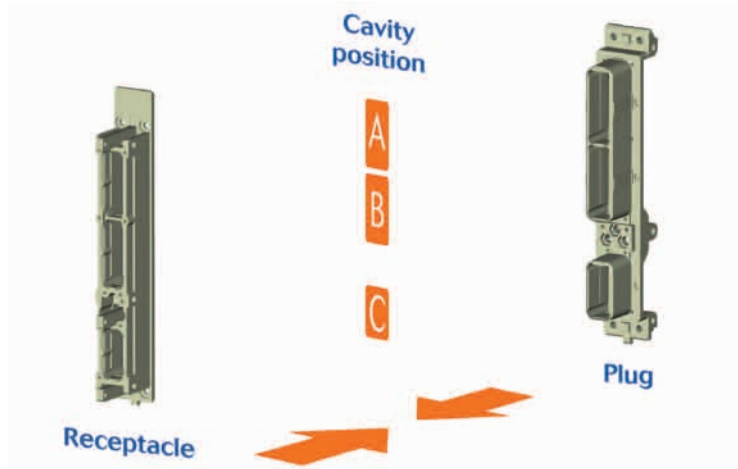

Shell Size 2

- ▶ 2 cavities "A & B" for Signal inserts (see page11)
- ▶ 1 cavity "C" for Power inserts (see page10)
- ▶ See page18 for shells dimensions

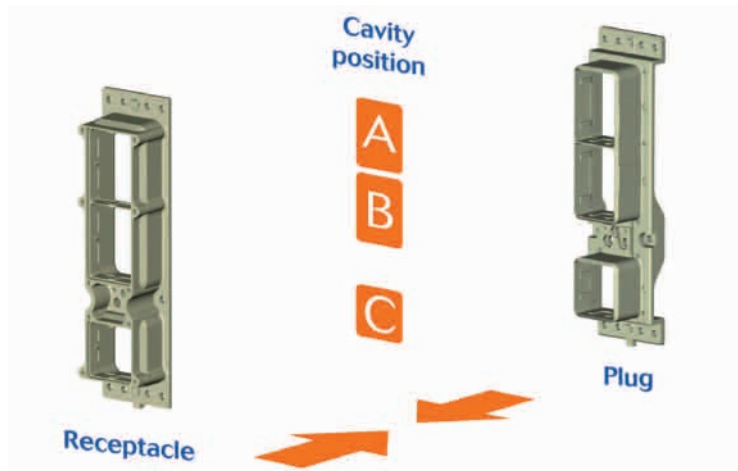

Shell Size 3

- ▶ 4 cavities "A, B, D & E" for Signal inserts (see page11)
- ▶ 2 cavities "C & F" for Power inserts (see page10)
- ▶ See page19 for shells dimensions

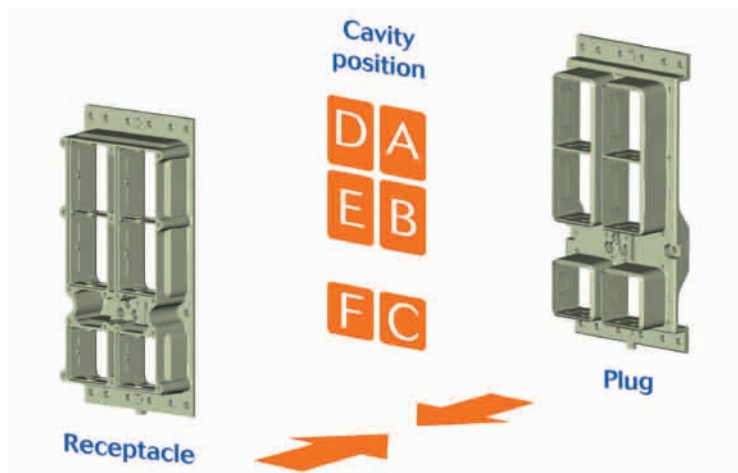

ARINC 600 Series



Cost Effective ARINC

- High performance avionic equipment
- Rack and panel rectangular connectors compliant to ARINC 600 specifications
- High density up to 800 signal contacts
- Low insertion force contact design (tapered pin, LIF socket)
- Unsealed versions
- Multiple polarizing positions
- Field replaceable inserts, featuring:
 - Non removable contacts
 - Signal contacts

Technical features

Mechanical

- **Shell:**
Aluminum alloy to QQ-A-591
- **Shell plating:**
 - . Alodine 1200 passivation to MIL-C-5541 class 1
 - . Nickel
- **Contact:**
Copper alloy to QQ-B-626
- **Contact plating:**
Gold plated compliant to MIL-G-45204 over nickel to QQ-N290
- **Insulator:**
Thermoplastic

- **Endurance:**
500 mating/unmating operations
- **Insertion and extraction forces max:**
 - . Shell size 2: 267N (60 lbs)
 - . Shell size 3: 467N (105 lbs)
- **Vibrations:**
 - . 8 hours in each axis
 - . Random vibration at 16.4 g Rms from 50 to 2000 Hz (MIL-STD-1344 A method 2005-1)
- **Dynamic shock:**
3 impacts of 50 g in all axis, duration 11 μ s (half wave) to MIL-STD-202 method 213

Electrical

- **Dielectric withstanding voltage:**

	Sea level	15 000 m
Mated	1500 Vrms	500 Vrms
Unmated	1500 Vrms	500 Vrms

- **Voltage rating:**
 - . 500 Vac Max
 - . 125 Vac at 21000 m
- **Insulation resistance:**
 $\geq 5000 M\Omega$

Environmental

- **Operating temperature:**
-65°C to +125°C
- **Resistance to salt spray:**
48 hours (MIL-STD-202 method 101 or MIL-STD-1344 method 1001)

ARINC 600 Series

Cost Effective ARINC Comparison with standard ARINC 600 Series



Do you see any difference between these two connectors?

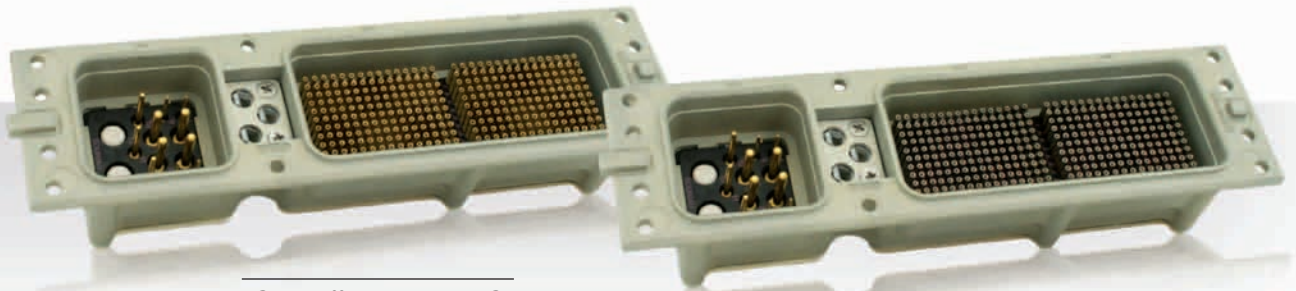

Cost Effective ARINC

Standard ARINC

No? Read below

The technical characteristics of the Cost Effective ARINC compared to the Standard are:

- Selective gold plating - Active part
- Non removable contacts
- Insert modification (one piece part)
- No contact marking, no insert marking
- Insert always pre-loaded with contacts



This technology allows you to SAVE money!

In Addition:

Possibility to MIX cost effective and standard inserts in the same shell

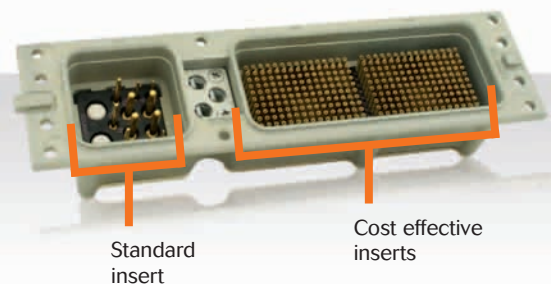

Standard insert

Cost effective inserts

ARINC 600



Mechanics

■ Sealing level & plating	18
■ Grounding	18
■ Shell size & shell type	19
■ Contact mounting & release	22
■ Mounting style	22
■ Inserts arrangement code:	
Power insert - cavities C & F	23
Signal insert - cavities A, B, D & E	24
■ Polarization	25
■ Packaging	27



ARINC 600 Series

Sealing level & plating

Sealing level & plating											
Basic Series	Code	Class		Sealing features			Grounding spring for plug only	Polarization			Plating
		Sealed	Unsealed	Compound	O-ring for plug only	Grommet		Standard	Grounding blade	Grounding finger	
SB6	0	✓		✓	✓	✓		✓			Alodine
	1		✓					✓			Alodine
	2	✓		✓		✓		✓			Alodine
	3	✓				✓		✓			Alodine
	9		✓			✓		✓			Alodine
	A	✓				✓			✓		Alodine
	B		✓						✓		Alodine
	C	✓		✓	✓	✓				✓	Alodine
	D		✓							✓	Alodine
	G	✓					✓				Nickel
	H	✓		✓			✓			✓	Alodine
	L	✓					✓		✓		Alodine
	N		✓				✓	✓			Nickel
	P	✓		✓	✓	✓	✓	✓	✓		Nickel

RoHS version: Please consult us. For other specification, please consult us.

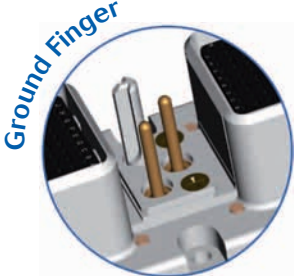
Grounding

Three solutions for shell continuity		
<p>Ground spring: Best continuity performance</p> <ul style="list-style-type: none"> • Spring with a nickel plating plug • The fixing ensures the shell continuity • Available in shell sizes 2 & 3 • Sealed and unsealed versions available 	<p>Ground finger: Cost effective solution</p> <ul style="list-style-type: none"> • Connection is ensured by a cable on the equipment • Available in shell sizes 1, 2 & 3 • Sealed and unsealed versions available 	<p>Ground blade: Cost effective solution</p> <ul style="list-style-type: none"> • Enables continuity between plug and receptacle • Available in shell sizes 2 & 3 • Sealed and unsealed versions available 

ARINC 600 Series

Shell Size & Shell Type

Shell Size 1 - Rack Plug (mm/inch)

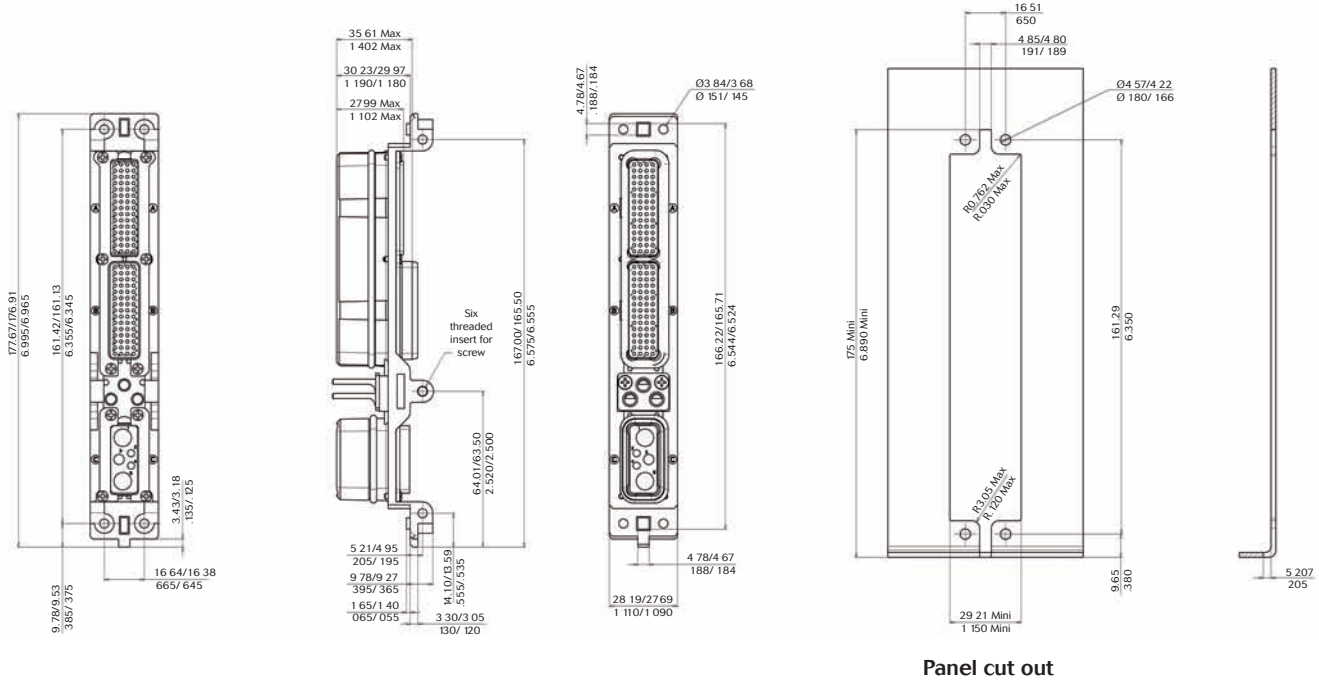

Panel cut out

Shell Size 1 - Equipment Receptacle (mm/inch)

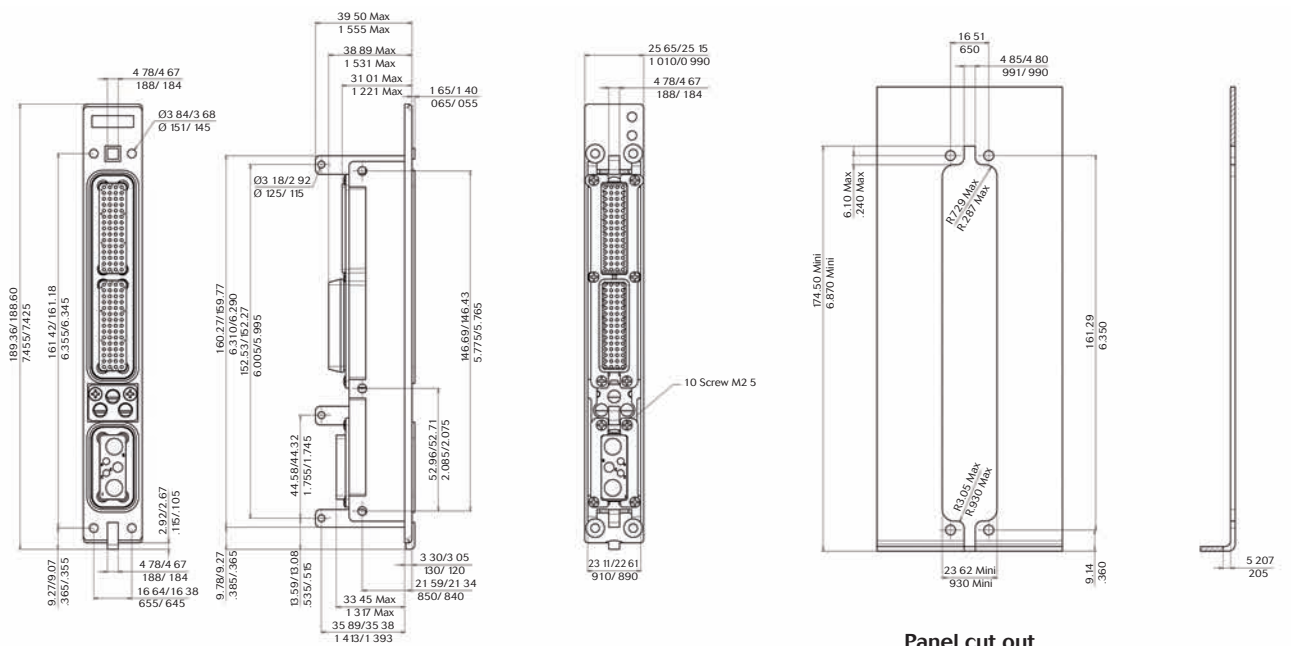

Panel cut out

ARINC 600 Series

Shell Size & Shell Type

Shell Size 2 - Rack Plug (mm/inch)

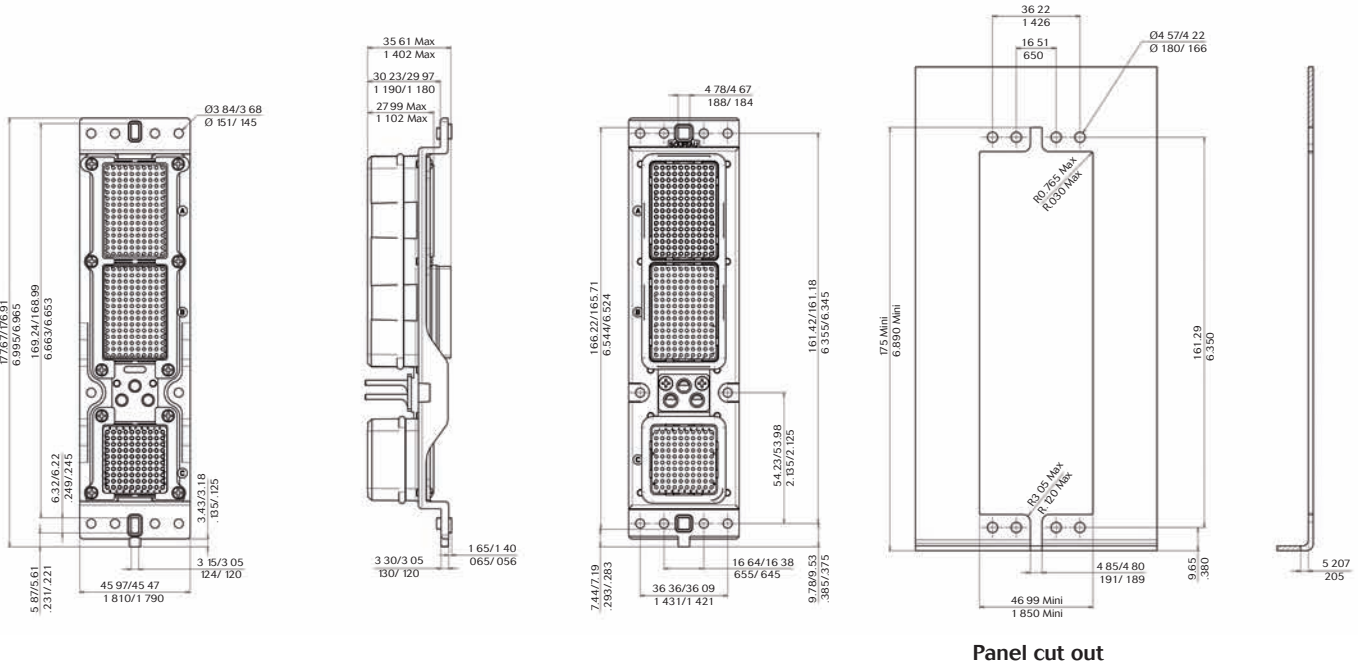

Shell Size 2 - Equipment Receptacle (mm/inch)

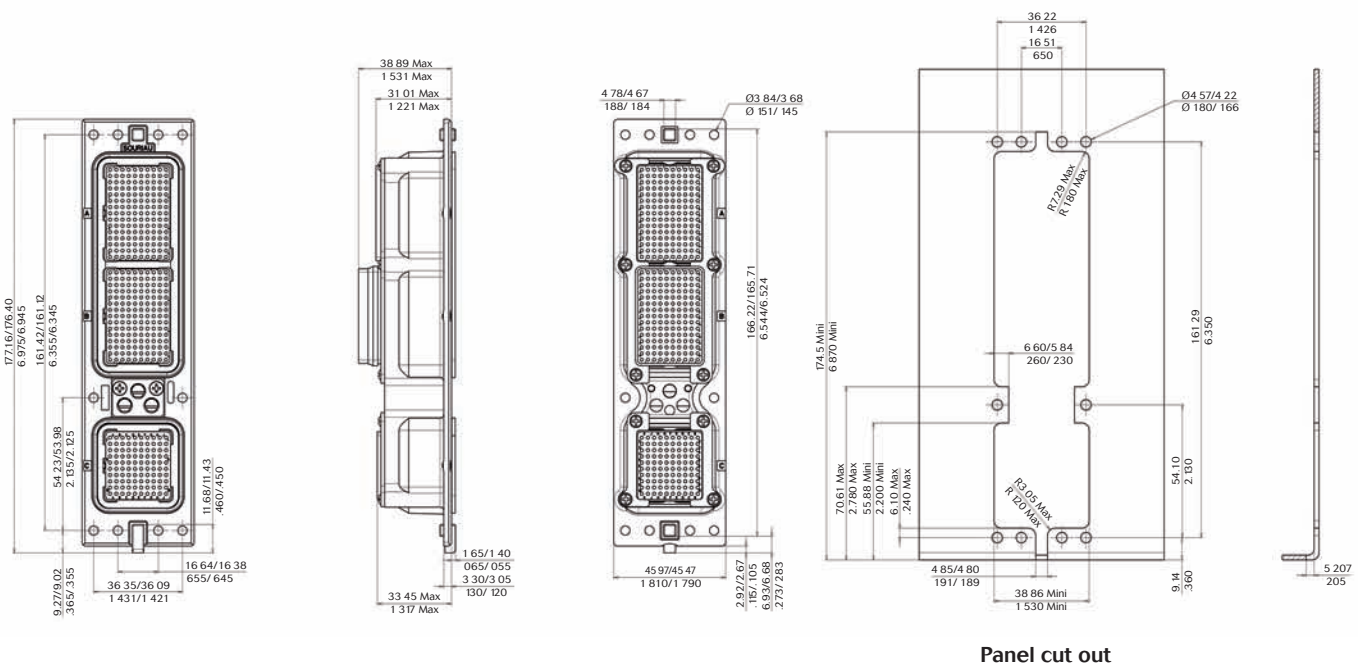

ARINC 600 Series

Shell Size & Shell Type

Shell Size 3 - Rack Plug (mm/inch)

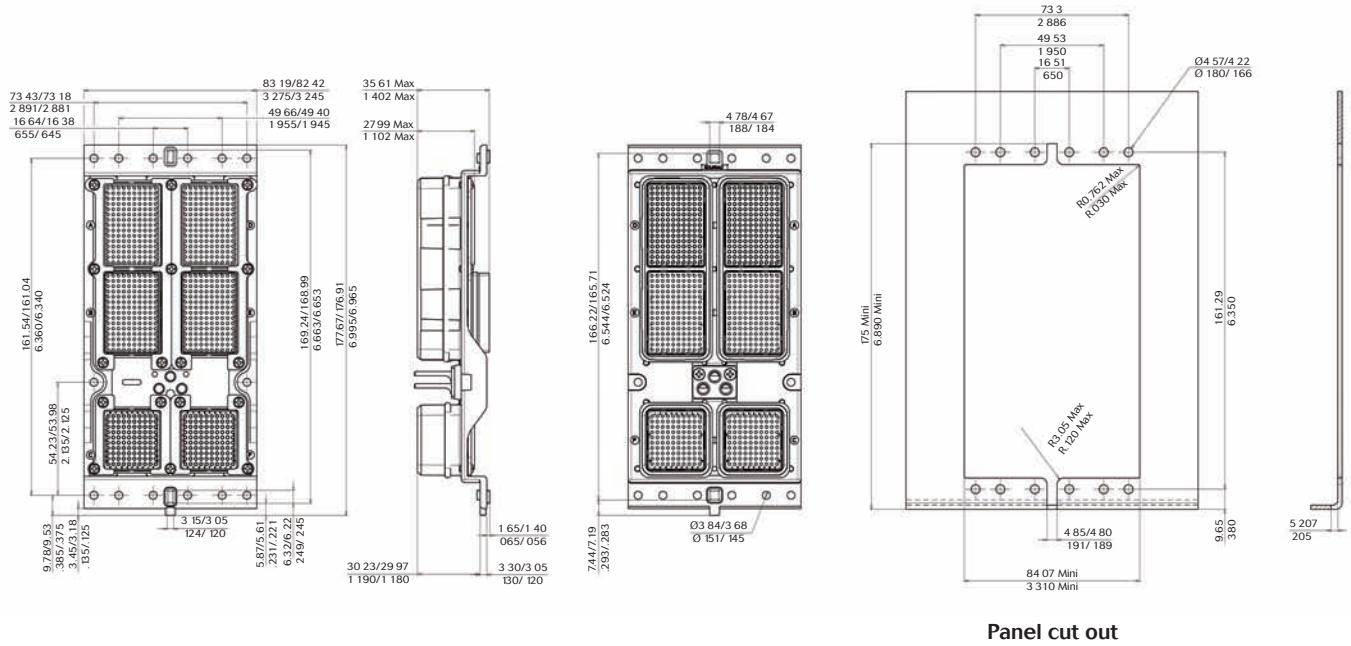

Shell Size 3 - Equipment Receptacle (mm/inch)

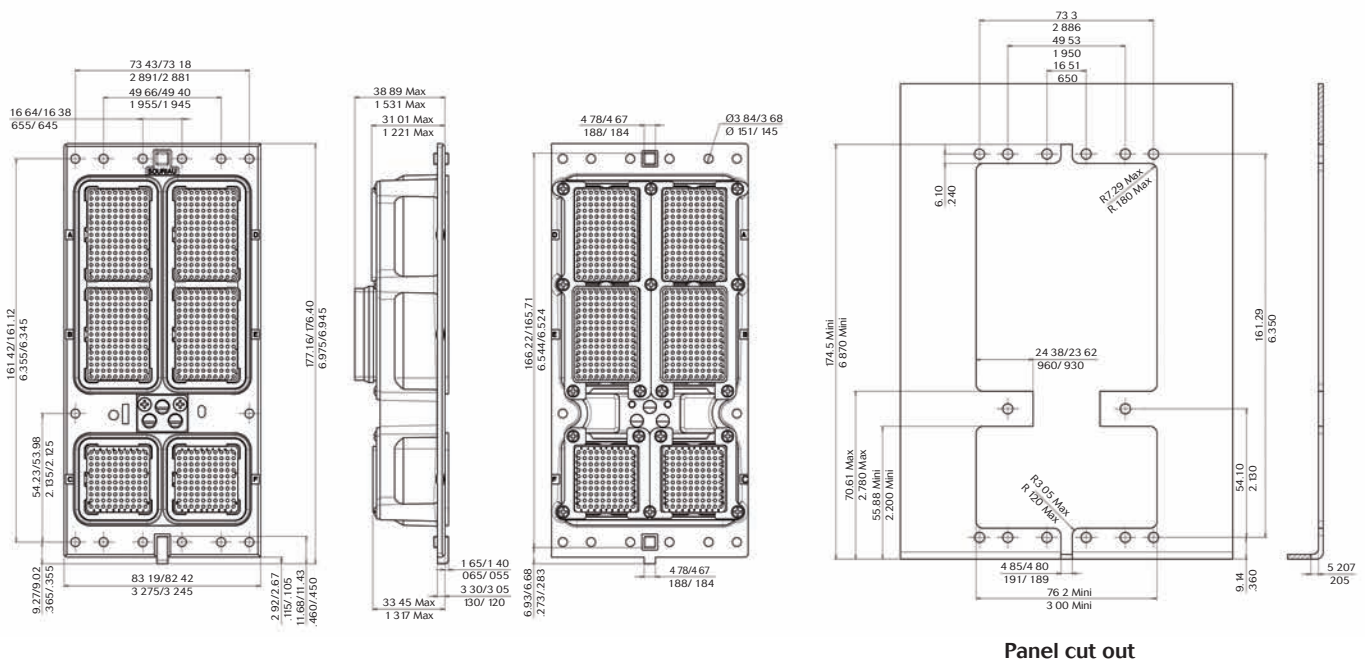

ARINC 600 Series

Contact Mounting & Release

Contact Mounting & Release

Possibility to mix rear & front release inserts within the same connector.

Equipment receptacle

Rear Release:
Crimped contacts & ELIO® fiber optic contacts

Front Release:
PC Tail contacts

Rack plug

Rear Release:
Crimped contacts & ELIO® fiber optic contacts

Mounting Style

Mounting Style

Standard mounting

05: Standard mounting shell size 1
13: Standard mounting shell size 2 & 3

Standard mounting size 1

Standard mounting size 2 & 3

Float mounting

FL: Float mounting, 6-32 eyelet (qty 4)
FN: Float mounting, 6-32 self-locking threaded inserts (qty 4)
FT: Float mounting, 4-40 (qty 4)
FS: Float mounting, 4-40 self-locking threaded inserts (qty 4)

Float mounting

Self-locking inserts

M3: M3 self-locking inserts, shells size 2 & 3 (qty 2)
N3: M3 self-locking inserts in all holes shells size 1, 2 & 3
LN: 6-32 self-locking threaded inserts *
SL: 4-40 self-locking threaded inserts *
TL: 4-40 self-locking threaded inserts in all holes
TN: 6-32 self-locking threaded inserts in all holes

Shells	Receptacle			Plug		
	1	2	3	1	2	3
Numbers of self-locking threaded inserts	4	6	10	4	4	8

Self-locking inserts

For other mounting styles, please consult us.

ARINC 600 Series

Inserts Arrangement Code

Power Insert - Cavities C and F

Code	Shell Size	C cavity	F cavity
W2	1	5W2	-
W2	2 & 3	11C2	11C2
00	1 & 2	Dummy insert (Polyamide)	-
01	3	Dummy insert (Polyamide)	Dummy insert (Polyamide)
02		11C2	Dummy insert (Polyamide)
03		Dummy insert (Polyamide)	11C2
07	1 & 2	Dummy insert (Alodine)	-
07	3	Dummy insert (Alodine)	Dummy insert (Alodine)
08	2 & 3	Dummy insert (Nickel)	Dummy insert (Nickel)
34	2	34 pts	-
34	3	34 pts	34 pts
38	1	40 pts	-
A1	2	85 pts	-
A2	3	11C2	Empty
A6		85 pts	85 pts
A8		85 pts	Dummy insert (Polyamide)
K1		100 pts	100 pts
K2		11C2	100 pts
K3		100 pts	11C2
K4	1 & 2	Empty	-
K4	3	Empty	Empty
K5	2	100 pts	-
Q1	2 & 3	68Q2	68Q2
Q2	3	100 pts	68Q2
Q3	2 & 3	11Q2	11Q2
Q4		62Q2	62Q2
Q6		Q6	Q6
Q8	3	68Q2	85 pts
Q9	2 & 3	20Q4	20Q4
QA	3	34 pts	Q6
R1		11Q2	68Q2
R2		11Q2	100 pts
R3		11Q2	Empty
R4		68Q2	11Q2
T8		2 & 3	20T4
T9	62T2		62T2

For other combination, please consult us.

ARINC 600 Series

Signal Insert - Cavities A, B, D and E

Code	Shell Size	A cavity	B cavity	D cavity	E cavity
00	1	60 pts	60 pts	-	-
00	2 & 3	150 pts	150 pts	150 pts	150 pts
01		71 pts	71 pts	71 pts	71 pts
02	2	150 pts	71 pts	-	-
03		71 pts	150 pts	-	-
04	2	Empty	71 pts	-	-
05	3	C2	C2	Empty	150 pts
07	2	Dummy insert	71 pts	-	-
08	3	71 pts	71 pts	71 pts	71 pts
09		150 pts	150 pts	150 pts	71 pts
78	3	TCAS	TCAS	Dummy insert	150 pts
A1*	2 & 3	71 pts	71 pts	71 pts	71 pts
A2*	2	150 pts	71 pts	-	-
A3*		71 pts	150 pts	-	-
B2	2	121 pts	121 pts	-	-
E1	1 & 2	Empty	Empty	-	-
E2	1	60 pts	Empty	-	-
E2	2	150 pts	Empty	-	-
E3	1	Empty	60 pts	-	-
E3	2	Empty	150 pts	-	-
E5		Empty	28 pts	-	-
E6	2	C2	71 pts rev.	-	-
E7	3	C2	C2	C2	150 pts
F2	2	150 pts	Wave guide	-	-
F3		Wave guide	150 pts	-	-
F5	2 & 3	22 ELIO®	22 ELIO®	22 ELIO®	22 ELIO®
H1	2	28 pts	28 pts	-	-
H2		150 pts	28 pts	-	-
H3		28 pts	150 pts	-	-
H4		71 pts	28 pts	-	-
H5		28 pts	Dummy insert	-	-
HA	3	150 pts	150 pts	150 pts	28 pts
HB		150 pts	150 pts	28 pts	150 pts
HC		150 pts	150 pts	28 pts	28 pts
HD		150 pts	28 pts	150 pts	150 pts
HE		150 pts	28 pts	150 pts	28 pts
HF		150 pts	28 pts	28 pts	150 pts
HG		150 pts	28 pts	28 pts	28 pts
HH		28 pts	150 pts	150 pts	150 pts
HJ		28 pts	150 pts	150 pts	28 pts
HK		28 pts	150 pts	28 pts	150 pts
HL		28 pts	150 pts	28 pts	28 pts
HM		28 pts	28 pts	150 pts	150 pts
HN	28 pts	28 pts	150 pts	28 pts	
HP	28 pts	28 pts	28 pts	150 pts	

Code	Shell Size	A cavity	B cavity	D cavity	E cavity
HQ	2 & 3	28 pts	28 pts	28 pts	28 pts
HR	3	28 pts	150 pts	28 pts	Dummy insert
HS		Empty	Empty	Dummy insert	150 pts
HV		150 pts	150 pts	Dummy insert	Dummy insert
HW		Dummy insert	150 pts	150 pts	150 pts
HX		Dummy insert	Dummy insert	Dummy insert	28 pts
Hy		Dummy insert	Dummy insert	Dummy insert	Dummy insert
HZ		Dummy insert	150 pts	28 pts	28 pts
K1		2	126	150 pts	-
K2	126		126	-	-
K3	150 pts		126	-	-
L1	1 & 2	Dummy insert	Dummy insert	-	-
L2	1	60 pts	Dummy insert	-	-
L2	2	150 pts	Dummy insert	-	-
L3	1	Dummy insert	60 pts	-	-
L3	2	Dummy insert	150 pts	-	-
QA	2 & 3	Q11	Q11	Q11	Q11
QB		150 pts	Q11	150 pts	Q11
QC	3	TCAS	TCAS	118Q2	118Q2
QD	2 & 3	Q11	Dummy insert	Q11	Dummy insert
QE		Q11	150 pts	Q11	150 pts
QF	2	Dummy insert	Q11	-	-
QG	3	150 pts	71 pts	150 pts	Q11
QH		Q11	Q11	150 pts	Q11
QJ	2 & 3	118Q2	118Q2	118Q2	118Q2
QK	3	Q11	Q11	Q11	150 pts
QL	2 & 3	Q10	150 pts	Q10	150 pts
QM	2	Dummy insert	118Q2	-	-
QN		71 pts	118Q2	-	-
QR	2 & 3	150 pts	118Q2	150 pts	118Q2
QS	3	150 pts	Q11	150 pts	Q11
QT		Q11	Q11	150 pts	150 pts
QU		Q11	150 pts	150 pts	150 pts
QV	2	Q11	Empty	-	-
QW	3	24 pts	Q10	60 pts	Q10
QX		Empty	150 pts	Empty	Q11
T1	2	60 pts	60 pts	-	-
T3		TCAS	TCAS	-	-
T4		TCAS	150 pts	-	-
T5		150 pts	TCAS	-	-
T6	3	TCAS	TCAS	150 pts	150 pts
T7	2	C12T6	150 pts	-	-
T8		TCAS	118Q2	-	-
T9		TCAS	118T2	-	-

For other combination, please consult us.

* with coaxial body assembly

ARINC 600 Series

Polarization Code

Polarization Code

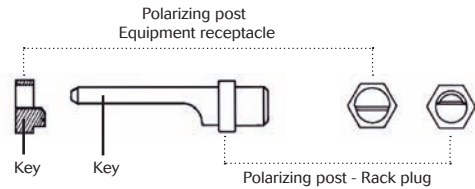
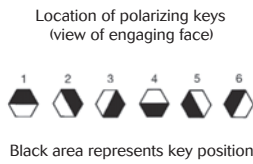
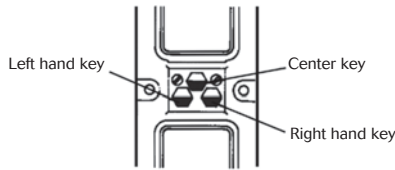

Code number	Receptacle Shell			Plug shell		
	Left key	Center key	Right key	Left post	Center post	Right post
00	-	-	-	-	-	-
01	4	4	4	1	1	1
02	4	4	3	2	1	1
03	4	4	2	3	1	1
04	4	4	1	4	1	1
05	4	4	6	5	1	1
06	4	4	5	6	1	1
07	5	4	4	1	1	6
08	5	4	3	2	1	6
09	5	4	2	3	1	6
10	5	4	1	4	1	6
11	5	4	6	5	1	6
12	5	4	5	6	1	6
13	6	4	4	1	1	5
14	6	4	3	2	1	5
15	6	4	2	3	1	5
16	6	4	1	4	1	5
17	6	4	6	5	1	5
18	6	4	5	6	1	5
19	1	4	4	1	1	4
20	1	4	3	2	1	4
21	1	4	2	3	1	4
22	1	4	1	4	1	4
23	1	4	6	5	1	4
24	1	4	5	6	1	4
25	2	4	4	1	1	3
26	2	4	3	2	1	3
27	2	4	2	3	1	3
28	2	4	1	4	1	3
29	2	4	6	5	1	3
30	2	4	5	6	1	3
31	3	4	4	1	1	2
32	3	4	3	2	1	2
33	3	4	2	3	1	2
34	3	4	1	4	1	2
35	3	4	6	5	1	2
36	3	4	5	6	1	2
37	4	3	4	1	2	1
38	4	3	3	2	2	1
39	4	3	2	3	2	1
40	4	3	1	4	2	1
41	4	3	6	5	2	1
42	4	3	5	6	2	1
43	5	3	4	1	2	6
44	5	3	3	2	2	6
45	5	3	2	3	2	6
46	5	3	1	4	2	6
47	5	3	6	5	2	6
48	5	3	5	6	2	6
49	6	3	4	1	2	5

Code number	Receptacle Shell			Plug shell		
	Left key	Center key	Right key	Left post	Center post	Right post
50	6	3	3	2	2	5
51	6	3	2	3	2	5
52	6	3	1	4	2	5
53	6	3	6	5	2	5
54	6	3	5	6	2	5
55	1	3	4	1	2	4
56	1	3	3	2	2	4
57	1	3	2	3	2	4
58	1	3	1	4	2	4
59	1	3	6	5	2	4
60	1	3	5	6	2	4
61	2	3	4	1	2	3
62	2	3	3	2	2	3
63	2	3	2	3	2	3
64	2	3	1	4	2	3
65	2	3	6	5	2	3
66	2	3	5	6	2	3
67	3	3	4	1	2	2
68	3	3	3	2	2	2
69	3	3	2	3	2	2
70	3	3	1	4	2	2
71	3	3	6	5	2	2
72	3	3	5	6	2	2
73	4	2	4	1	3	1
74	4	2	3	2	3	1
75	4	2	2	3	3	1
76	4	2	1	4	3	1
77	4	2	6	5	3	1
78	4	2	5	6	3	1
79	5	2	4	1	3	6
80	5	2	3	2	3	6
81	5	2	2	3	3	6
82	5	2	1	4	3	6
83	5	2	6	5	3	6
84	5	2	5	6	3	6
85	6	2	4	1	3	5
86	6	2	3	2	3	5
87	6	2	2	3	3	5
88	6	2	1	4	3	5
89	6	2	6	5	3	5
90	6	2	5	6	3	5
91	1	2	4	1	3	4
92	1	2	3	2	3	4
93	1	2	2	3	3	4
94	1	2	1	4	3	4
95	1	2	6	5	3	4
96	1	2	5	6	3	4
97	2	2	4	1	3	3
98	2	2	3	2	3	3
99	2	2	2	3	3	3

ARINC 600 Series

Polarization Code

Code number		Receptacle Shell			Plug shell		
Souriau	Norm	Left key	Center key	Right key	Left post	Center post	Right post
A0	100	2	2	1	4	3	3
A1	101	2	2	6	5	3	3
A2	102	2	2	5	6	3	3
A3	103	3	2	4	1	3	2
A4	104	3	2	3	2	3	2
A5	105	3	2	2	3	3	2
A6	106	3	2	1	4	3	2
A7	107	3	2	6	5	3	2
A8	108	3	2	5	6	3	2
A9	109	4	1	4	1	4	1
B0	110	4	1	3	2	4	1
B1	111	4	1	2	3	4	1
B2	112	4	1	1	4	4	1
B3	113	4	1	6	5	4	1
B4	114	4	1	5	6	4	1
B5	115	5	1	4	1	4	6
B6	116	5	1	3	2	4	6
B7	117	5	1	2	3	4	6
B8	118	5	1	1	4	4	6
B9	119	5	1	6	5	4	6
C0	120	5	1	5	6	4	6
C1	121	6	1	4	1	4	5
C2	122	6	1	3	2	4	5
C3	123	6	1	2	3	4	5
C4	124	6	1	1	4	4	5
C5	125	6	1	6	5	4	5
C6	126	6	1	5	6	4	5
C7	127	1	1	4	1	4	4
C8	128	1	1	3	2	4	4
C9	129	1	1	2	3	4	4
D0	130	1	1	1	4	4	4
D1	131	1	1	6	5	4	4
D2	132	1	1	5	6	4	4
D3	133	2	1	4	1	4	3
D4	134	2	1	3	2	4	3
D5	135	2	1	2	3	4	3
D6	136	2	1	1	4	4	3
D7	137	2	1	6	5	4	3
D8	138	2	1	5	6	4	3
D9	139	3	1	4	1	4	2
E0	140	3	1	3	2	4	2
E1	141	3	1	2	3	4	2
E2	142	3	1	1	4	4	2
E3	143	3	1	6	5	4	2
E4	144	3	1	5	6	4	2
E5	145	4	6	4	1	5	1
E6	146	4	6	3	2	5	1
E7	147	4	6	2	3	5	1
E8	148	4	6	1	4	5	1
E9	149	4	6	6	5	5	1
F0	150	4	6	5	6	5	1
F1	151	5	6	4	1	5	6
F2	152	5	6	3	2	5	6
F3	153	5	6	2	3	5	6
F4	154	5	6	1	4	5	6
F5	155	5	6	6	5	5	6
F6	156	5	6	5	6	5	6
F7	157	6	6	4	1	5	5

Code number		Receptacle Shell			Plug shell		
Souriau	Norm	Left key	Center key	Right key	Left post	Center post	Right post
F8	158	6	6	3	2	5	5
F9	159	6	6	2	3	5	5
G0	160	6	6	1	4	5	5
G1	161	6	6	6	5	5	5
G2	162	6	6	5	6	5	5
G3	163	1	6	4	1	5	4
G4	164	1	6	3	2	5	4
G5	165	1	6	2	3	5	4
G6	166	1	6	1	4	5	4
G7	167	1	6	6	5	5	4
G8	168	1	6	5	6	5	4
G9	169	2	6	4	1	5	3
H0	170	2	6	3	2	5	3
H1	171	2	6	2	3	5	3
H2	172	2	6	1	4	5	3
H3	173	2	6	6	5	5	3
H4	174	2	6	5	6	5	3
H5	175	3	6	4	1	5	2
H6	176	3	6	3	2	5	2
H7	177	3	6	2	3	5	2
H8	178	3	6	1	4	5	2
H9	179	3	6	6	5	5	2
J0	180	3	6	5	6	5	2
J1	181	4	5	4	1	6	1
J2	182	4	5	3	2	6	1
J3	183	4	5	2	3	6	1
J4	184	4	5	1	4	6	1
J5	185	4	5	6	5	6	1
J6	186	4	5	5	6	6	1
J7	187	5	5	4	1	6	6
J8	188	5	5	3	2	6	6
J9	189	5	5	2	3	6	6
K0	190	5	5	1	4	6	6
K1	191	5	5	6	5	6	6
K2	192	5	5	5	6	6	6
K3	193	6	5	4	1	6	5
K4	194	6	5	3	2	6	5
K5	195	6	5	2	3	6	5
K6	196	6	5	1	4	6	5
K7	197	6	5	6	5	6	5
K8	198	6	5	5	6	6	5
K9	199	1	5	4	1	6	4
L0	200	1	5	3	2	6	4
L1	201	1	5	2	3	6	4
L2	202	1	5	1	4	6	4
L3	203	1	5	6	5	6	4
L4	204	1	5	5	6	6	4
L5	205	2	5	4	1	6	3
L6	206	2	5	3	2	6	3
L7	207	2	5	2	3	6	3
L8	208	2	5	1	4	6	3
L9	209	2	5	6	5	6	3
M0	210	2	5	5	6	6	3
M1	211	3	5	4	1	6	2
M2	212	3	5	3	2	6	2
M3	213	3	5	2	3	6	2
M4	214	3	5	1	4	6	2
M5	215	3	5	6	5	6	2
M6	216	3	5	5	6	6	2

ARINC 600 Series

Packaging Code

Packaging Code		
1st Letter: Delivery conditions of Signal and Power Contacts		
A	Connector delivered with unmounted crimped signal and power contacts.	For rear release plug & receptacle.
B	Connector delivered only with unmounted crimped signal contacts.	-
C	Connector delivered with mounted wire wrap L= 12.7/0.5 (mm/inch) signal contacts and without power contact.	-
D	Connector delivered with unmounted wire wrap L= 9.52/0.375 (mm/inch) signal contacts and crimped power contacts.	-
E	Connector delivered with mounted PC Tail L= 6.35/0.25 (mm/inch) signal contacts and unmounted power crimped contacts.	For PC Tail gold plated only. See code 3 for tin plated.
G	Connector delivered with mounted gold plated PC Tail L= 3.81/0.15 (mm/inch) signal contacts and without power contact.	-
H	Connector delivered with mounted tin plated PC Tail L= 6.35/0.25 (mm/inch) signal and power contacts.	For PC Tail tin plated only. See code Y for gold plated.
I	Connector delivered with mounted PC Tail L= 3.81/0.15 (mm/inch) signal contacts and unmounted crimped power contacts.	-
L	Connector delivered without signal and without power contact.	Never use code LN. If no contact, put nothing.
N	Connector delivered with only unmounted crimped power contacts.	-
P	Connector delivered with mounted PC Tail L= 9.52/0.375 (mm/inch) signal contacts and unmounted crimped power contacts.	-
R	Connector delivered with mounted gold plated PC Tail L= 9.52/0.375 (mm/inch) signal contacts and without power contact.	-
T	Connector delivered with mounted wire wrap L= 12.7/0.5 (mm/inch) signal contacts and with unmounted power contacts.	-
U	Connector delivered with mounted wire wrap L= 6.35/0.25 (mm/inch) signal contacts and without power contact.	-
W	Connector delivered with unmounted front release wire wrap contacts (4 wrappings: 8660-540)	-
X	Connector delivered with mounted PC Tail L= 12.7/0.5 (mm/inch) signal contacts and without power contact.	For PC Tail gold plated only. See code 2 for tin plated.
Y	Connector supplied with mounted #22 PC Tail L= 6.35/0.25 (mm/inch) signal and power contacts.	For PC Tail gold plated only. See code H for tin plated.
1	Connector delivered with mounted PC Tail wire wrap L= 9.52/0.375 (mm/inch) signal contacts and with unmounted crimped power contacts.	-
2	Connector delivered with mounted tin plated PC Tail L= 12.7/0.5 (mm/inch) signal contacts and without power contact.	For PC Tail tin plated only. See code X for gold plated.
3	Connector delivered with mounted tin plated PC Tail L= 6.35/0.25 (mm/inch) signal contacts and with unmounted crimped power contacts.	For PC Tail tin plated only. See code E for gold plated.
4	Connector delivered with tin plated PC Tail L=1 2.7/0.5 (mm/inch) signal and power contacts.	-
5	Connector delivered without signal contacts and with tin plated PC Tail L= 6.35 / 0.25 (mm/inch) power contacts.	-
2nd Letter: Delivery conditions of #5 Coax and #1 Coax contacts, and #8 Quadrax contacts.		
A	Connector delivered with #5 coax for RG 58 C/U cable and #1 coax for RG 165/U and RG 225/U cable (coaxial body and termination kit).	
B	Connector delivered with #1 coax for RG 141A/U, RG 142 and KX23 cable. Delivered unmounted.	
C	Connector delivered with #1 coax for UT 141 and RG 400B/U cable. Delivered unmounted.	
D	Connector delivered with #5 coax for 5021K1011 cable.	
E	Connector delivered with #1 coax for RG 393/U cable.	
F	Connector delivered with #5 coax for 5021K1011 cable and with #1 coax for RG 393/U cable. Delivered unmounted.	
H	Connector delivered without coax contact and with #5 dummy contacts.	
I	Connector delivered without coax contact and with mounted #5 and #12 cavity reducer.	
J	Connector delivered with #5 coax for RG 316 cable.	
K	Connector delivered with #5 coax for KX23 cable.	
M	Connector delivered with unmounted sealed #5 coax for RG 58C/U cable.	
N	Connector delivered without coax or quadrax contact.	
Q	Connector delivered with #8 PC tail quadrax contacts: Same plating than signal and power contacts, or tin plated if not applicable.	
S	Connector delivered with TCAS #1 coax.	
Packaging code not applicable to connectors where no contacts are specified. Do not use the suffix LN together. Gold plated contacts: 0.8µ mini. Performance compliant with ARINC 600. For other code packaging, please consult us.		

Note: All dimensions are in mm/inch.

ARINC 600



Contacts & Tooling





■ Crimp contacts	30
■ PC tail contacts	34
■ Wire wrap contacts	35
■ Twinax contacts	35
■ Triax contacts	36
■ Quadrax contacts	36
■ Cavity reducers	36
■ ELIO® fiber optic contacts/adaptor #8	37
■ Filler plug	38
■ Dummy contacts	38
■ Dummy inserts	38
■ Tooling:	
Crimping tools	39
Insertion & extraction of the contacts	40
Insertion & extraction tools	41
■ Accessories: Covers	41

ARINC 600 Series

Contacts

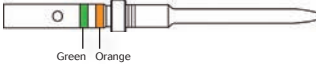

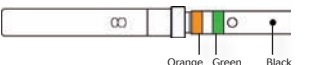

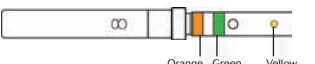
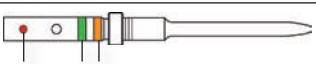
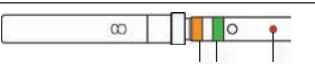

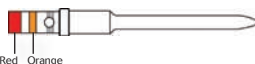

Crimp Contacts

Signal contacts

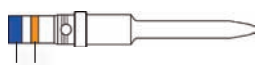
Contact size	For rack plug: rear release			For equipment receptacle: rear release		
	Contact type	Part number	Profile and color code	Contact type	Part number	Profile and color code
#22 Standard	Pin	8660-6412*	 Green Orange	Socket	8660-206	 Orange Green
#22 Alumel		8660-209	 Black Green Orange		8660-211	 Orange Green Black
#22 Chromel		8660-208	 Yellow Green Orange		8660-210	 Orange Green Yellow
#22 Constantan		8660-2029	 Red Green Orange		8660-2034	 Orange Green Red

* Selective plating ASNE0170FA2200 - Best value for money solution !
Available without selective plating: 8660-202

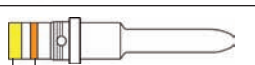
Power contacts

Contact size	For rack plug: rear release			For equipment receptacle: rear release		
	Contact type	Part number	Profile and color code	Contact type	Part number	Profile and color code
#20 Power	Socket	8660-248	 Orange Red	Pin	8660-230	 Red Orange
#16 Power		8660-249	 Orange Blue		8660-233	 Blue Orange
#16 Power Small barrel		8660-2575	 Orange		8660-1048	 Orange
#12 Power		8660-250	 Orange Yellow		8660-236	 Orange Yellow
#12 Power Small barrel		8660-257	 Orange		8660-1049	 Orange

ARINC 600 Series

Crimp Contacts

Coaxial contacts

Contact size	Class	For rack plug: Female contact	For equipment receptacle: Male contact	Cable
		Part number	Part number	
#8 Coaxial	Unsealed	8660-6211	8660-6251	RG 400 / U
	Sealed	8660-2485	8660-2480	RG 58 C / U RG 142 B / U RG 141 A / U NSA 935359 WB
#5 Coaxial*	Unsealed	8660-2285	8660-2280	RG 174 A / U RG 188 A / U
	Sealed	8660-2486	8660-2481	RG 223 / U RG 400 BU KX 23
	Unsealed	8660-2286	8660-2281	RG 178 B / U RG 196 A / U RG 316 / U KX 21 A KX 22 A
	Sealed	8660-2487	8660-2482	RG 180 B / U RG 195 A / U
	Unsealed	8660-2287	8660-2282	5021 K 1011
	Sealed	8660-2488	8660-2483	
	Unsealed	8660-2288	8660-2283	
	Sealed	8660-2489	8660-2484	
	Unsealed	8660-2289	8660-2284	
	Sealed	8660-2298E	8660-2294	
Unsealed	8660-2498E	8660-2494		

* Sealing sleeve supplied for sealed connectors

Contact size	Class	For rack plug: Female contact			For equipment receptacle: Male contact			Cable
		Coaxial	Termination kit	Coaxial assembly	Coaxial	Termination kit	Coaxial assembly	
#1 Coaxial	Sealed	8660-2277	8660-2587	8660-2296	8660-2272	8660-2581	8660-2251	RG 141 A / U RG 142 B / U KX 23
	Unsealed	8660-2278		8660-2261	8660-2274		8660-2241	
	Sealed	-	-	-	8660-2272	8660-2582	8660-2252	UT141
	Unsealed	-	-	-	8660-2274		8660-2242	
	Sealed	8660-2277	8660-2580	8660-2295	8660-2272	8660-2583	8660-2250	RG 165 / U RG 214 / U RG 225 / U
	Unsealed	8660-2278		8660-2260	8660-2274		8660-2240	
	Sealed	8660-2277	8660-2585	8660-2299	8660-2272	8660-2588	8660-2254	RG 393 / U
	Unsealed	8660-2278		8660-2263	8660-2274		8660-2244	
	Sealed	8660-2277	8660-2237	8660-2311	8660-2272	8660-2236	8660-2313	Fileca1703 / 3 Filotex50MT KT
	Unsealed	8660-2278		8660-2259	8660-2274		8660-2314	
Unsealed	8660-2278	8660-2341	8660-2141	-	-	-	RG 400 / BU	

For rack plug: Female contact

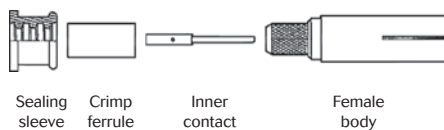

For equipment receptacle: Male contact



ARINC 600 Series

Crimp Contacts

Coaxial assembly example

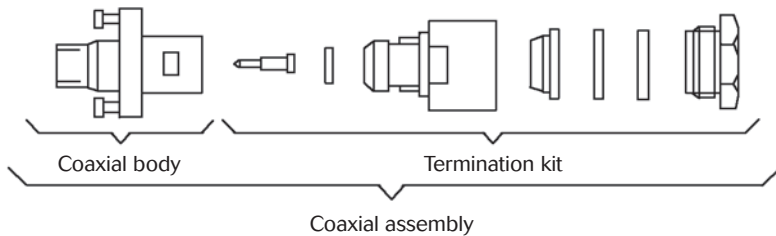



Triaxial contacts

Contact size	Class	For rack plug: Female contact	For equipment receptacle: Male contact	Cable
		Part number	Part number	
#8 Triaxial	Sealed	8667-D03-08R-52A/01 Included boot	8667-D02-08R-52A/01 Included boot	EN3375-004 MIL-C-17176
	Unsealed	8667-D03-08R-02A/01	8667-D02-08R-02A/01	

Wire data for crimp contacts

Contact size	Cables		Ø over insulation (mm/inch)	
	mm ²	AWG	min	max
#22	0.15 to 0.38	26 - 24 - 22	0.66 / 0.026	1.371 / 0.054
#20	0.21 to 0.60	24 - 22 - 20	1.016 / 0.04	1.803 / 0.071
#16	0.60 to 1.34	20 - 18 - 16	1.727 / 0.068	2.616 / 0.103
#16 Small barrel	0.21 to 0.93	24 - 22 - 20 - 18	1.73 / 0.068	2.6 / 0.102
#12	1.91 to 3.18	14 - 12	2.464 / 0.097	3.429 / 0.135
#12 Small barrel	0.21 to 0.93	24 - 22 - 20 - 18	2.48 / 0.098	3.4 / 0.134

TCAS insert

Contact size	Shell style	Part number	Profile	Cable
#1 Coaxial	Plug	8660-D21-100-01A/05		FILOTEX E0406WD FILOTEX 50MFCFB
		8660-6413		GORESW39214
	Receptacle	8660-6136		Output SMA

ARINC 600 Series

Crimp Contacts

Specific contacts for 28 pts insert

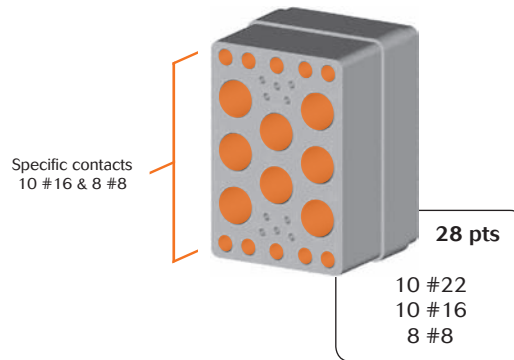

#8 Triaxial contact

Contact size	Class	For rack plug: Female contact		For equipment receptacle: Male contact		Cable
		Part number	Profile	Part number	Profile	
#8 Triaxial	Sealed	8599-5220 Included boot		8599-5210 Included boot		Mil-C17176 -00002
	Unsealed	8599-0998		8599-0988		

#16 Power rear release

Contact size	Contact type	Part numbers without colour code	MIL - DTL - 38999 contacts	
			Part number	Profile and colour code
#16 Power	Pin	8599-0704 MJ	M39029/58-364	
	Socket	8599-0708	M39029/56-352	

#16 Dummy contacts (unsealed version)

#16 (38999)	for plug	8660-3138	Blue
	for receptacle	8660-3139	

ARINC 600 Series

PC Tail Contacts

For equipment receptacle: socket signal contacts - front release

Contact size	Contact type	Part number	L = Length PC tail	Ø PC tail	Profile
#22	Gold plated	8660-550	3.81 / 0.15	0.60 / 0.024 min 0.67 / 0.026 max	
		8660-555	6.35 / 0.25		
		8660-560	9.52 / 0.375		
		8660-565	12.7 / 0.5		
	Tin plated	8660-C23-22V-01A/06	3.81 / 0.15		
		8660-C23-22V-02A/06	6.35 / 0.25		
		8660-C23-22V-03A/06	9.52 / 0.375		
		8660-C23-22V-04A/06	12.7 / 0.5		

For equipment receptacle: pin power contacts - front release

Contact size	Contact type	Part number	L = Length PC tail	Ø PC tail	Profile
#20	Gold plated	8660-420-200-04AMJ	3.81 / 0.15	0.81 / 0.032 min 0.88 / 0.035 max	
		8660-420-200-01AMJ	6.35 / 0.25		
		8660-420-200-02AMJ	9.52 / 0.375		
		8660-420-200-03AMJ	12.7 / 0.5		
	Tin plated	8660-420-200-04A06	3.81 / 0.15		
		8660-420-200-01A06	6.35 / 0.25		
		8660-420-200-02A06	9.52 / 0.375		
		8660-420-200-03A06	12.7 / 0.5		
#16	Gold plated	8660-420-160-04AMJ	3.81 / 0.15	1.27 / 0.050 min 1.33 / 0.052 max	
		8660-420-160-01AMJ	6.35 / 0.25		
		8660-420-160-02AMJ	9.52 / 0.375		
		8660-420-160-03AMJ	12.7 / 0.5		
	Tin plated	8660-420-160-04A06	3.81 / 0.15		
		8660-420-160-01A06	6.35 / 0.25		
		8660-420-160-02A06	9.52 / 0.375		
		8660-420-160-03A06	12.7 / 0.5		
#12	Gold plated	8660-420-120-04AMJ	3.81 / 0.15	2.05 / 0.081 min 2.11 / 0.083 max	
		8660-420-120-01AMJ	6.35 / 0.25		
		8660-420-120-02AMJ	9.52 / 0.375		
		8660-420-120-03AMJ	12.7 / 0.5		
	Tin plated	8660-420-120-04A06	3.81 / 0.15		
		8660-420-120-01A06	6.35 / 0.25		
		8660-420-120-02A06	9.52 / 0.375		
		8660-420-120-03A06	12.7 / 0.5		
#8	Gold plated	Please consult us			

For equipment receptacle: pin power contacts - rear release

Contact size	Contact type	Part number	L = Length PC tail	Ø PC tail	Profile
#20	Gold plated	8660-543	2.98 / 0.117	0.81 / 0.032 min 0.88 / 0.035 max	
	Tin plated	8660-6148			
#16	Gold plated	8660-546	2.38 / 0.094	1.27 / 0.050 min 1.33 / 0.052 max	
	Tin plated	8660-6149			
#12	Gold plated	8660-549	2.98 / 0.117	2.05 / 0.081 min 2.11 / 0.083 max	
	Tin plated	8660-6150			

Note: All dimensions are in mm/inch.

ARINC 600 Series

PC Tail Contacts

For equipment receptacle: pin specific contacts for 62Q2 & 121 pts inserts



Contact size	Contact type	Part number	L = Length PC tail	Ø PC tail (mm)	Profile
#20	Tin plated	8660-420-200-05A/06	6.35 / 0.25	0.81 / 0.032 min 0.88 / 0.035 max	-
#16	Tin plated	8660-420-160-05A/06	6.35 / 0.25	1.27 / 0.050 min 1.33 / 0.052 max	

Wire Wrap Contacts - Front release

For equipment receptacle: socket contacts

Contact Size	Contact type	Part number	L = Length PC tail		Profile
#22	Gold plated	8660-223	6.35 / 0.25	0.82 / 0.032 min 0.90 / 0.035 max	
		8660-224	9.52 / 0.375		
		8660-225	12.7 / 0.5		

Twinax Contacts

Contact size	Contact type	Part number	Cable	Profile
#8 twinax	Female (For Rack plug)	ETH2-1105A	ABS0386WF24	
		ETH2-1107A	ASNE0272TK22	
		ETH2-1103A	ASNE0272TK24	
		ETH2-1101A	ASNE0807WX26	
	Male (For equipment receptacle)	ETH2-1104A	ABS0386WF24	
		ETH2-1106A	ASNE0272TK22	
		ETH2-1102A	ASNE0272TK24	
		ETH2-1100A	ASNE0807WX26	

Note: All dimensions are in mm/inch.



ARINC 600 Series

Triax Contacts

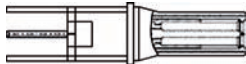
For equipment receptacle: male contact front release





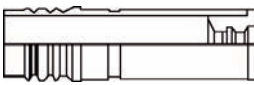

Contact size	Contact type	Part number	L = Length PC tail	Profile
#8 Triax	Tin plated	8660-6046	6.35 / 0.25	

Quadrax Contacts

Contact size	Contact type	Part number	Version	Class	Release	Profile
#8 Quadrax	Male	ETH1-1100A	Crimp	Unsealed	Rear	
	Female	ETH1-1101A				
	Male	ETH1-1110A	PC Tail L = 6.35/0.25	Unsealed	Front	
		ETH1-1123A	Tinned PC Tail L = 6.35/0.25			
-	-	8660-6053	Sealing boot	Sealed	-	

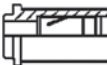
Cable: ABS0972 - KB24 - ABS1503 - KD24

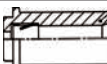
Cavity Reducers

Cavity Reducers Used for rear release insert	For equipment receptacle		For rack plug	
	Part number	Profile	Part number	Profile
From size 5 cavities to size 12 contacts	8660-343		8660-344	
	8660-6440 (front release)		-	
From size 8 cavities to size 12 contacts	8660-537		8660-536	
From size 8 cavities to size 16 contacts (38999 type)	8660-3134		8660-3133	

Note: All dimensions are in mm/inch.

ARINC 600 Series

ELIO® Fiber Optic Contacts

ELIO® Contacts Ordering Information

ELIO	09	N	G	L	A
Cable external diameter:					
09: 0.9 mm or cable wider than 1.9mm with 0.9mm jacket inside					
18: from 1.5mm to 1.9mm					
Contact sealing:					
W: waterproof (1.8mm +/- 0.1mm cable only)					
N: non waterproof					
Fibre type:					
G: 50 or 62,5/125 µm					
D: 100/140 µm					
<i>For singlemode fibre (9/125) please consult us.</i>					
Boot type:					
L: Long boot					
S: Short boot					
N: No boot (non waterproof version only)					
Contact version index					

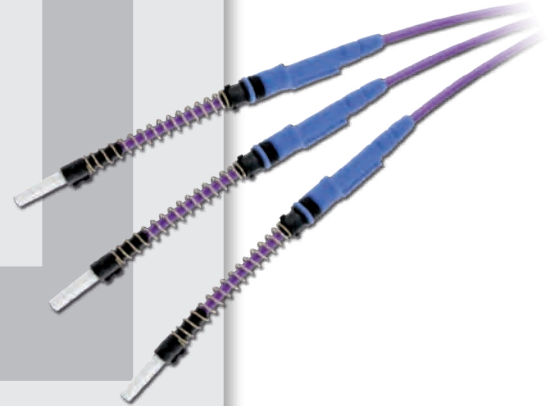

ELIO® AQ: Adaptor for Quadrax #8 Cavities

- ARINC 600 connector can integrate ELIO® fiber optic contacts in #8 quadrax cavities with the addition ELIO® #8 adaptor.
- Insertion loss: 0.3 dB per contact.
- Possibility to mix optical and electrical signals in the same insert.
- Flight proven at temperature range -65°C +125°C.
- Designed to comply with ELIO® contact optical performances.

Part number	Adaptor type	Profile
ELIOAQOP * Rear release For receptacle	Male Insert	
ELIOAQ1P Front release For receptacle		
ELIOAQOS Rear release For plug	Female insert	

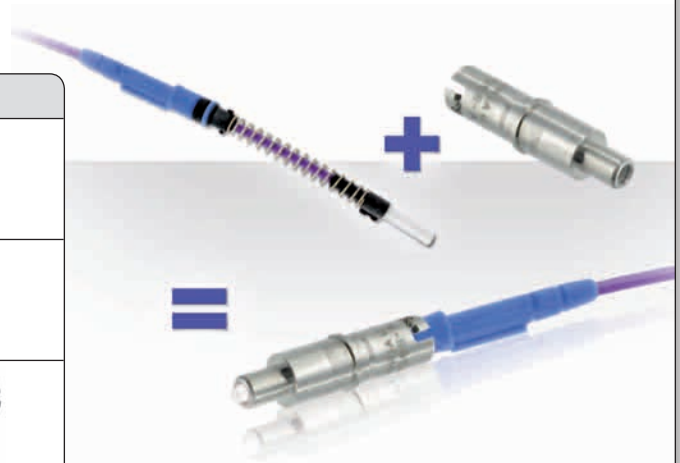

* Delivered with alignment boot

See Souriau «ELIO® Fiber Optic Technology» catalog for more information.

ARINC 600 Series

Filler Plug (sealed version)

Cavities size	Part number	Color
# 22	8660-212	Black
# 20	8522-389A	Red
# 16	8522-390A	Blue
# 12	8522-391A	Yellow
# 8	8660-3035	Red
# 5	8660-726	White

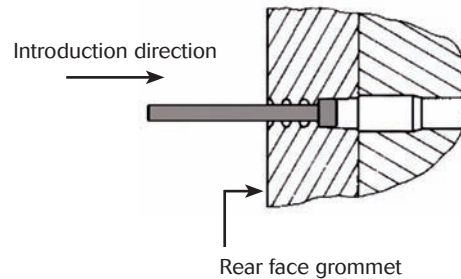

Dummy Contacts (unsealed version)

Cavity size	Part number	Color
#22 Rear release	8660-500 for receptacle	Black
#22 Front release	8660-499 for receptacle	Aluminium
#20	8660-501	Red
#16	8660-502	Blue
#12	8660-503	Yellow
#8	8660-3131 for plug	Red
	8660-3132 for receptacle	
#8 Quadrax Front release	8660-6045 for receptacle	Metal
#8 Rear release	8660-6108 for receptacle	
#5	8660-505 for plug	White
	8660-504 for receptacle	
#5 Front release	8660-942 for receptacle	Metal
#1 For TCAS insert	8660-6145A for receptacle	White

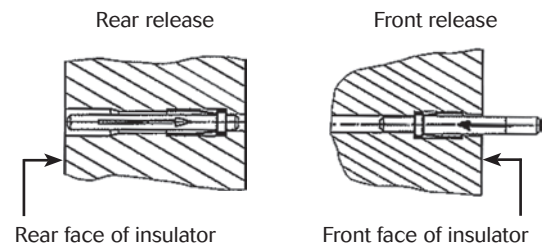

Dummy Inserts

Shell Size	Cavity	Material	Part Number
1	A, B	Polyamide*	8660-31A-100-01A/AA
	C	Polyamide*	8660-31A-100-02A/AA
2 & 3	A, B, D, E	Polyamide*	8660-31A-100-01A/AA
		Alodine	8660-34A-200-01A/F3
		Nickel	8660-34A-200-01A/SW
	C, F	Polyamide*	8660-31A-200-02A/AA
		Alodine	8660-34A-200-02A/F3
		Nickel	8660-34A-200-02A/SW



* Standard version

ARINC 600 Series

Tooling & Accessories

Crimping Tools

Sizes 22, 20, 16, 12 and Quadrax contacts

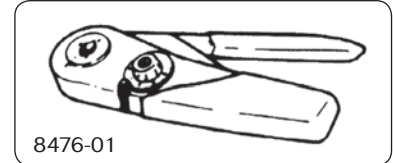
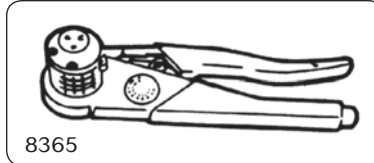
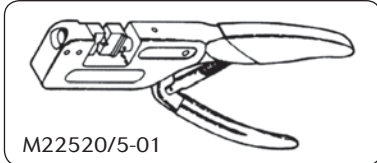

Contact size	Contact type	Plier M22520/5-01	Plier 8365 M22520/1-01		Plier 8476-01 M22520/2-01		Cables		
		P / N locator						mm ²	AWG
		Norm / Spec	Norm / Spec	Souriau	Norm / Spec	Souriau			
#22	F & M	-	-	-	M22520/2-23	8660-216	0.15 to 0.38	26 - 24 - 22	
#20	F & M	-	-	-	M22520/2-08	8476-08	0.21 to 0.60	24 - 22 - 20	
#16	F & M	-	M22520/1-02	8365-02	-	-	0.60 to 1.34	20 - 18 - 16	
#16 small barrel	F & M	-	M22520/1-02	8365-02	-	-	0.21 to 0.93	24 - 22 - 20 - 18	
#12	F & M	-	M22520/1-02	8365-02	-	-	1.91 to 3.18	14 - 12	
#12 small barrel	F & M	-	M22520/1-02	8365-02	-	-	0.21 to 0.93	24 - 22 - 20 - 18	
#8 Quadrax	Outer	M22520/5-45 die set repere B	-	-	-	-	-	-	
	Central	-	-	-	K709, setting number 5	-	-	-	

Note: Quadrax & Twinax Contacts, consult wiring instruction.

Size 5 Coaxial contacts

Contact part numbers		Pliers	
		Inner contact	Body (ferrule)
Sealed connector	Unsealed connector	8476-01 M22520/2-01	M22520/5-01
8660-2480/2485	8660-2280/2285	locator M22520/2-14	Hex dies
8660-2481/2486	8660-2281/2286		M22520/5-45B
8660-2482/2487	8660-2282/2287		M22520/5-37B
8660-2483/2488	8660-2283/2288		M22520/5-45B
8660-2484/2489	8660-2284/2289		M22520/5-37B
			M22520/5-43B

Note: Size 1 Coaxial contacts do not require assembly tooling.

TCAS contact: 8660-D21-100-01A/05

Contact	Plier M22520/1-01	Plier M22520/5-01	Cables
	P/N locator		
Inner contact	M22520/13SEL-8	-	FILOTEX E0406WD FILOTEX 50MFCFB
External contact	-	M22520/5-61	

ARINC 600 Series

Insertion and Extraction of the Contacts

Insertion of the contacts

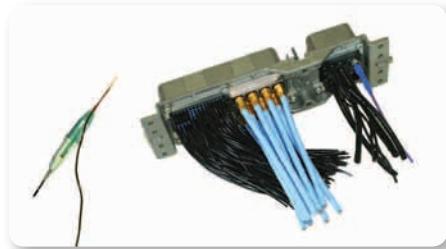

1 - Engage the crimp cable / contact assembly into the longitudinal slot of the plastic tool (coloured tip). Slide the tool down the cable until the tip of the tool abuts the contact retention shoulder.



2 - Introduce the contact into the required contact cavity in the insulator, pushing tool axially, until the contact snaps into position in clip.

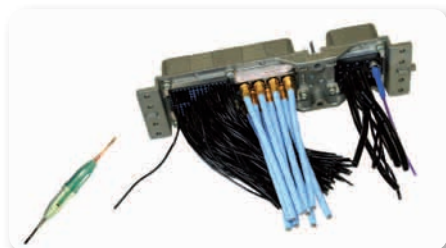

3 - Withdraw the tool (from rear). Check that contact is firmly locked by pulling wire gently. When connector is fully loaded, check the position of contact tips. They should all be in the same plane.

Nota : For larger sizes of cable which are stiff enough manual insertion without tool is preferable.

Extraction of the contacts

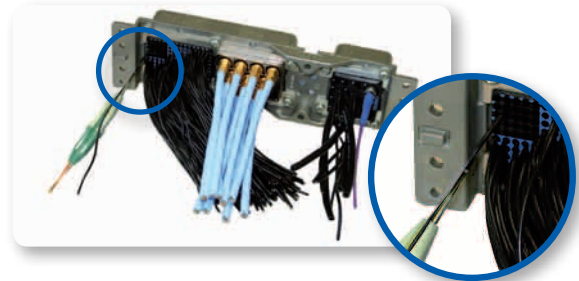

1 - Engage the appropriate cable into the longitudinal slot of the tool with the white tip towards connector.

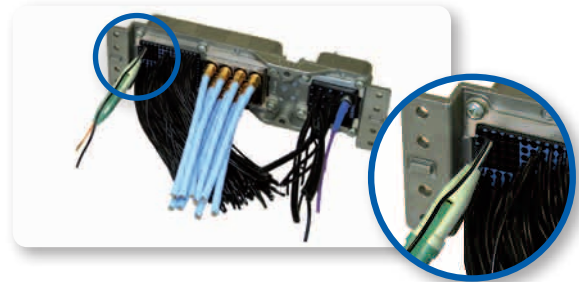

2 - Slide the tool down towards the contact. Insert the tool in the insulator until it abuts the contact shoulder.

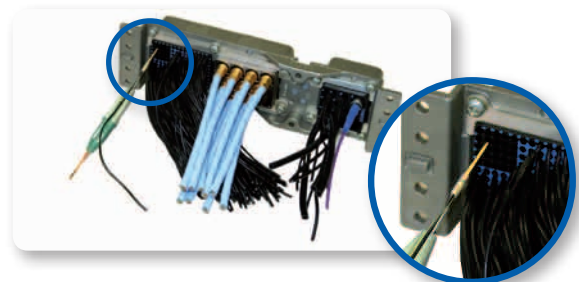

3 - Holding the tool-contact and cable assembly together, remove them simultaneously.

ARINC 600 Series

Insertion and Extraction Tools

Contact size	Release	Material	Part number		Insertion / Extraction tools		Note
			Spec	Souriau	Insertion	Extraction	
#22	Rear release	Metal	M81969/1-01	8660-160	Green	White	-
#20		Metal	M81969/1-02	8660-188	Red	White	-
#16		Metal	M81969/1-03	-	Blue	White	-
#12		Plastic	M81969/14-04	M81969/14-04	Yellow	White	-
#5		Metal	M81969/2801	8660-187	-	Yellow	Insertion = manual
#8	Front & rear release	Metal	-	8660-197	-	-	
#22 PC tail & Wire wrap	Front release	Metal	-	8660-162	Red	White	-

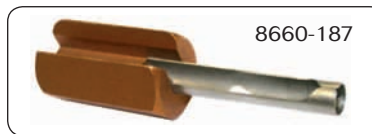
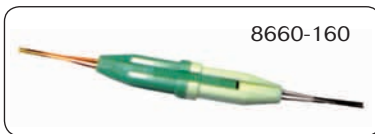

Accessories

Covers

Standard covers are supplied with connector (may be supplied separately)

Plug Covers

Yellow color.

Shells	Designation	Part number
1	For power block	8660 - 140
	For signal block	8660 - 141
2 & 3	For power block	8660 - 142
	For signal block	8660 - 143

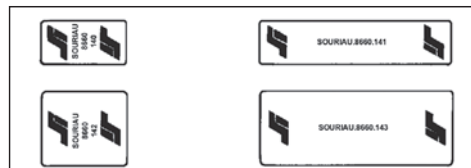

Antistatic Receptacle Covers

Black color.

These covers are designed to protect equipments against electrostatic discharge risks. They are in self-extinguishing polyphenylene with graphite filler.

Shells	Designation	Part number
1	For power block	8660 - 1404
	For signal block	8660 - 1405
2 & 3	For power block	8660 - 1406
	For signal block	8660 - 1407

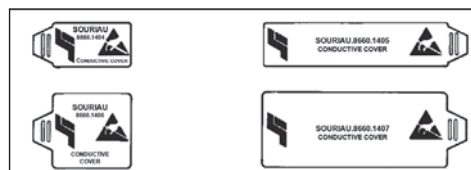

ARINC 600



ARINC 600 Series

Range Extension

■ Custom product	44
■ <i>microComp</i> [®] Series	44
■ D-Subminiature Series	45
■ NAFI 1 & 2	45



ARINC 600 Series

Products Range Extension

Custom Product

Souriau is offering a high development capability for your specific needs

- ① • **Specific monocavity**
 - available for any Souriau insulators (pictures: Q11 and 150pts layouts)
- ② • **Space saving solution**
 - With right angle cable orientator
 - 35mm outing length
- ③ • **Specific machined shells for customized needs**

CONSULT US

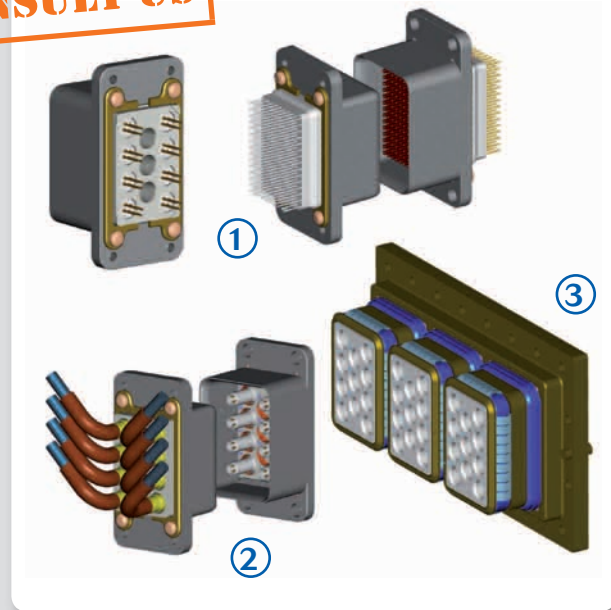

microComp® Series

To respond to miniaturization and weight saving trends in aeronautical and defense applications SOURIAU has developed an innovative high density connector range.

Very light & high density:

- . Shell in composite (or aluminum).
- . Up to 66% lighter than HD D-Sub.
- . Very high density up to 40% smaller than HD D-Sub.

Excellent features:

- . With crimp removable contacts for wire AWG 24 to 28.
- . Temperature up to 175°C.
- . High vibration and shock withstanding.
- . Standard MIL-STD 83513 accessories.
- . Compatible with high speed data rates (Gigabit Ethernet...).

Quick connect version:

- . MCQL microComp® Quick Latch.

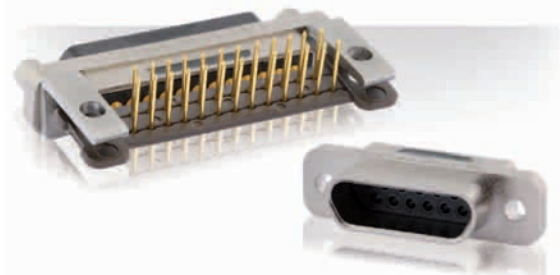

See «microComp® Series - Miniature High Density» catalog on www.souriau.com

ARINC 600 Series

Products Range Extension

D-Subminiature Series

Connectors designed to ensure the connection function in all applications where weight and dimension are very important. Especially used as Input/Output connectors in interface fonctions. Compliant with MIL/HE/NFC.

Space saving:

- . Miniature design.

A wide range:

- . 8630, SMA, 8635, hermetic.

Removable crimp contacts:

- . Size 20 for the Mark III.
- . Size 22D for the High Density Series.
- . PC tail version available.

Versatility:

- . Easy to handle.

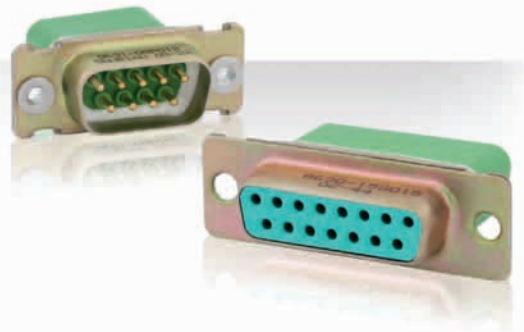

See «D-Subminiature Series - Rectangular Connectors» catalog on www.souriau.com

NAFI 1 & 2

PCB interconnection according to MIL-C 28754. Board-mounted connectors used as interface between daughter-boards and back planes or between two adjacent daughter-boards.

High vibration resistance:

- . Perfectly adapted to military PCB connection.

High Density:

- . 2.54 pitch (NAFI 1).
- . 1.27 pitch (NAFI 2).
- . Up to 556 contacts.

Large contacts offer:

- . Straight & angle contacts.
- . Straight PC tail with flex connection.
- . Press fit contacts.

