

ASX Multi-tone alarm sounder

- 228 mm cubic-design multi-tone alarm sounder
- Max. 127 dB (A) sound pressure
- High degree of protection IP 66
- Optional mounting type using metal bracket
- 63 tones can be selected, 3 tones can be switched externally

- Maximum sound pressure for all tones
- For industrial and general applications
- Combinations of multi-tone alarm sounders and beacons available

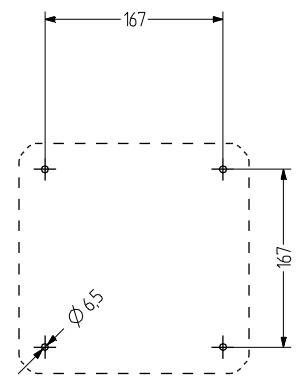
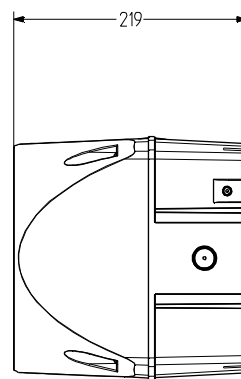
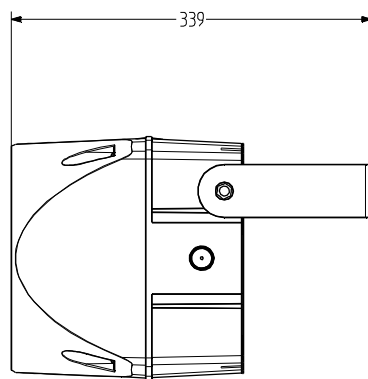
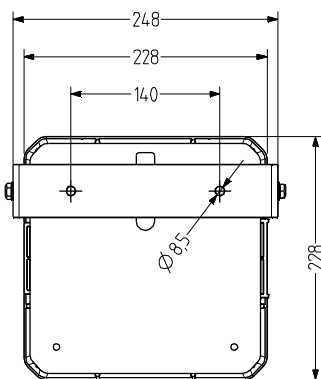

TECHNICAL DATA

Housing	Polycarbonate red (RAL 3000)
Type of mounting	any, Sound outlet opening at bottom or horizontal
Cable entry	Back: Grommet 5-10 mm Side: AKV cable gland M20 × 1.5 7-14 mm can be mounted
Connection technology	Screw/plug-in terminal up to 2,5 mm ²
Leakage current	0,003 A
Tone	63 Tones, 3 Tones can be switched externally, see tone table

Volume	127 dB
Tone frequency	150-3.100 Hz
Duty cycle	100 %
Operating temperature	-30 °C / +60 °C
Degree of protection	IP66 & UL Type 4/4x/13
Impact resistance	IK09
Weight	3,5 kg

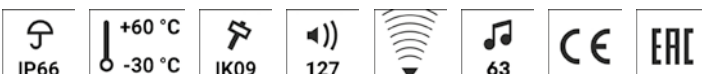

ASX

ORDER DATA

Nominal voltage	Voltage range (V)	Nominal current (A)	Mains frequency	Order number
48 V AC/DC	21-53 V AC	2,500	50-60 Hz	874 460 408
	21-60 V DC	1,700		
120 V AC	+/- 10 %	0,800	50-60 Hz	874 460 310
230 V AC	+/- 10 %	0,450	50-60 Hz	874 460 313



AMK



AB4



AG4



AKV













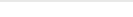

















ACCESSORIES

Type	Type of accessory	Weight	Order number
AMK	Mounting set for combining several pieces of signalling equipment of the same size	10 g	874 010 900
AB4	Mounting set for metal bracket for mounting in any direction (e.g. on mounting platforms)		874 034 900
AG4	Flat seal for correct IP66 installation on smooth surfaces		874 024 900
AKV	Cable gland M20x1,5		698 800 026



ASX

STONE TABLE

STAGE 1	Tone type	Frequency Hz	Pictogram	Repeat rate	Specific application	max dB	STAGE 2 S2	STAGE 3 S3
S1								
Tone 01	continuous	660			Swedish Alarm	116	Tone 16	Tone 12
Tone 02	continuous	1000			PFEER toxic gas	117	Tone 16	Tone 25
Tone 03	continuous	2400				124	Tone 21	Tone 17
Tone 04	intermittent	420		0,625 s on / 0,625 s off	Australian alert AS1670	114	Tone 21	Tone 01
Tone 05	intermittent	660		1,8 s on / 1,8 s off	Swedish Alarm	120	Tone 21	Tone 01
Tone 06	intermittent	660		0,15 s on / 0,15 s off	Swedish Alarm	116	Tone 16	Tone 01
Tone 07	intermittent	970		1 s on, 1 s off	PFEER Alarm, BS5839-1:2002	118	Tone 18	Tone 01
Tone 08	intermittent	970 (950)		0,5 s on/0,5 s off x 3 dann 1,5 s off	ISO 8201 low tone, US Temporal	120	Tone 16	Tone 03
Tone 09	intermittent	800		0,25 s on / 1 s off		120	Tone 27	Tone 03
Tone 10	intermittent	700		0,15 s on / 0,15 s off, total 1 min.	Swedish Alarm SS 031711	118	Tone 18	Tone 02
Tone 11	intermittent	720		0,7 s on / 0,3 s off	Industrial alarm Germany	119	Tone 02	Tone 29
Tone 12	intermittent	2400		0,5 s on / 0,5 s off		127	Tone 03	Tone 01
Tone 13	intermittent	2850		0,5 s on / 0,5 s off x 3 dann 1,5 s off	ISO 8201 high tone, US Temporal	120	Tone 03	Tone 17
Tone 14	alternating	440 - 554		0,4 s (440Hz) / 0,1 s (554Hz)	AFNOR France, NFS 32-001	116	Tone 16	Tone 01
Tone 15	alternating	554 - 440		1 Hz	Swedish Alarm	116	Tone 01	Tone 16
Tone 16	alternating	800 - 1000		2 Hz		120	Tone 02	Tone 09
Tone 17	alternating	2400 - 2900		2 Hz		125	Tone 03	Tone 01
Tone 18	alternating	1000 - 2000		1 Hz	Singapore	126	Tone 02	Tone 03
Tone 19	sweeping	500 - 1500		10 Hz		121	Tone 02	Tone 01
Tone 20	sweeping	150 - 1000		rising 10 s, 40 s on, falling 10 s	Industrial alarm Germany	116	Tone 01	Tone 29
Tone 21	continuous	400		simulated Horn		112	Tone 16	Tone 02
Tone 22	sweeping	500 - 1200		rising in 3,75 s/ 0,25 s off	Australian evacuation AS 2220	120	Tone 02	Tone 09
Tone 23	sweeping	500 - 1200		rising in 3,5 s/ 0,5 s off	Netherlands NEN 2575:2000	121	Tone 02	Tone 09
Tone 24	sweeping	500 - 1200		0,5 s on/0,5 s off x 3 / 1,5 s off	Australian evacuation AS1670	120	Tone 02	Tone 09
Tone 25	abfallend	1200 - 500		1 Hz	German evacuation DIN 33404-3	122	Tone 02	Tone 32
Tone 26	sweeping	500 - 1200		0,3 Hz		122	Tone 01	Tone 32
Tone 27	sweeping	1400 - 1600		rising in 1 s/falling in 0,5 s	NFC 48-265	124	Tone 02	Tone 09
Tone 28	sweeping	2400 - 2900		1 Hz		123	Tone 17	Tone 03
Tone 29	bell					122	Tone 16	Tone 02
Tone 30	slow rise	500 - 2400		siren rising 3 s, then continuous 2400 Hz		126	Tone 16	Tone 01
Tone 31	slow rise	300 - 1200		siren rising 3 s, then continuous 1200 Hz		113	Tone 16	Tone 01
Tone 32	chime	970 - 800		repeating ding-dong, 1 Hz		119	Tone 29	Tone 01