

PING)))™ Bracket Kit (#570-28015)

The PING))) Bracket Kit includes a standard servo and all mounting hardware required to attach the PING))) ultrasonic sensor to the front of the Parallax Boe-Bot® robot (or any custom-made robot chassis with a flat mounting spot on the front).

You may also purchase additional hardware from Parallax to mount the HM55B Compass Module to the same mounting bracket. That hardware is not included in this kit but is available from a hardware store or the Parallax web site. See page 4 for more information.

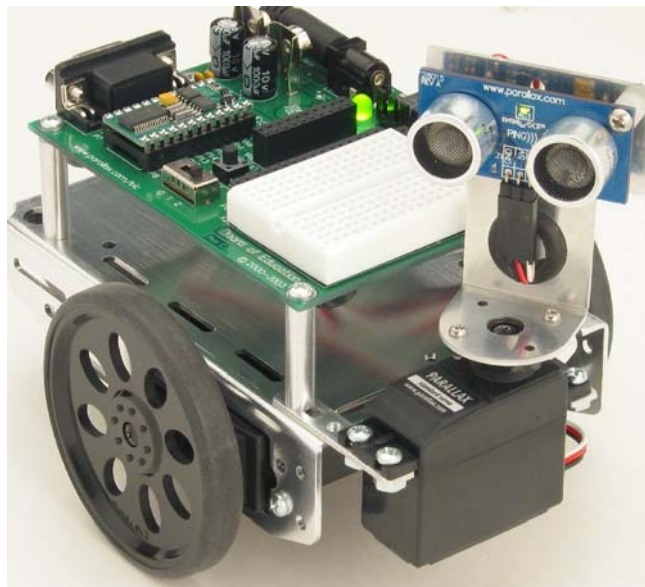

Features

- Parallax Standard Servo provides 180 degrees of ultrasonic scanning ability
- Clean and sturdy connection provides reliable use on mobile robots
- Example BASIC Stamp® code for using the mounted PING))) sensor with a Boe-Bot robot can be downloaded for free from http://www.parallax.com/detail.asp?product_id=570-28015

Bill of Materials

Part#	Qty	Description
700-00003	7	4/40 nut, zinc plated
700-00015	3	Nylon washer (size 4)
700-00025	1	Rubber grommet – 13/32" size
700-00028	5	4/40 ¼" long panhead Phillips screw
700-00062	2	2/56 ¼" long panhead Phillips screw
710-00006	2	4/40 ½" long panhead Phillips screw
711-00001	2	2/56 nut
713-00005	2	Nylon spacer ¼" long (size 4)
720-00012	2	Straight bracket
720-28015	1	PING))) mounting bracket
805-00001	1	Servo extension cable 10"
900-00005	1	Parallax Standard Servo

Tools Required

- A 3/32" drill bit or an X-Acto® knife
- A #2 Philips screwdriver (such as the Parallax screwdriver included in the Boe-Bot Robot Kit)

Assembly Instructions

Step 1:

Enlarge two holes on the standard servo horn with a 3/32" (2.0 mm) drill bit or the tip of an X-Acto knife. Use caution in this step since the servo horn plastic is quite brittle and can crack if it is enlarged with a screw.

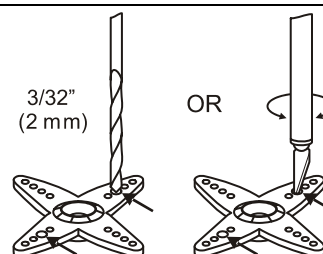

Step 2:

Attach the PING))) mounting bracket to the servo horn using (2) 2/56 1/4" long screws and nuts. Put the rubber grommet in the bracket's larger hole.

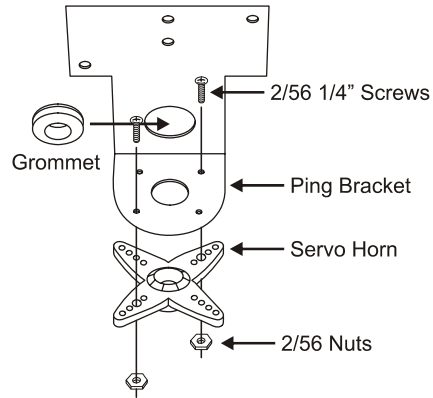

Step 3:

The mounting holes on the PING))) mounting bracket accommodate both Futaba and Hitec servo sizes and locations. Identify the proper holes for your servo.

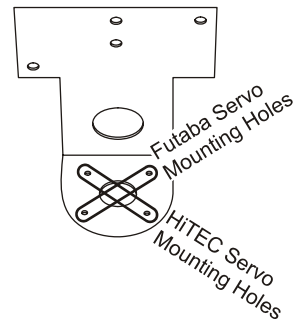

Step 4:

As viewed from the top, attach the PING))) ultrasonic sensor to the PING))) mounting bracket using (2) 4/40 1/2" long screws, (2) 1/4" long nylon spacers and (2) 4/40 nuts.

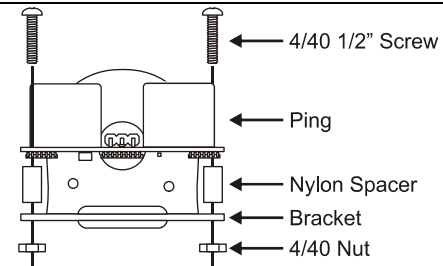

Step 5:

Disconnect power, then remove the Board of Education® and four standoffs from the Boe-Bot chassis. The Board of Education's front right mounting position will be used for the straight bracket attachments; the other one will mount on one of the chassis's front slots using a 4/40 1/4" screw and nut. Install (3) nylon washers under the other three standoffs and replace the Board of Education on the chassis so it remains level.

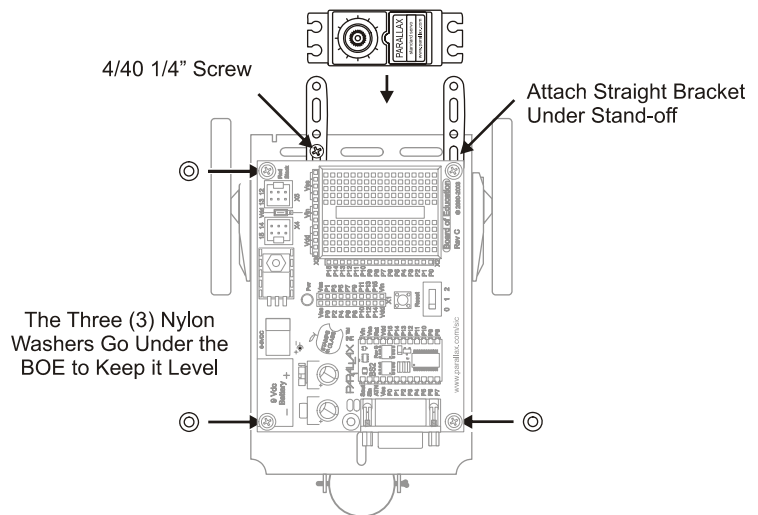

Step 6:

Attach the PING))) Mounting Bracket and servo to the straight brackets using (4) 4/40 screws and (4) 4/40 nuts. Replace the servo's shaft screw once the PING))) Mounting Bracket is installed.

Important: Before using the servo screw, adjust the Ping))) bracket to rotate 90° left and right.

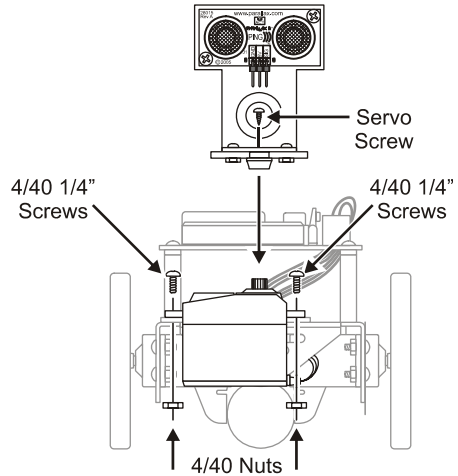

Step 7:

Set the Servo Port Jumper on the Board of Education to Vdd, then plug the servo into servo port 14.

Note: If your board has no servo ports, or no servo port jumper, or if you want to keep the servos connected to Vin instead of Vdd, follow the Breadboard Connection section on page 3.

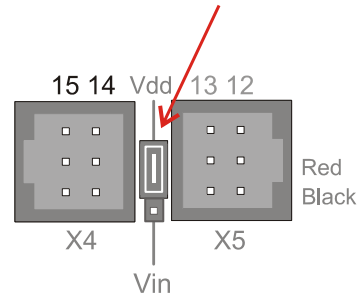

Step 8:

Connect the servo extension cable to the PING))) sensor: Black to GND, Red to 5 V, and White to SIG.

Plug the other end of the Ping))) sensor's cable into servo port 15.

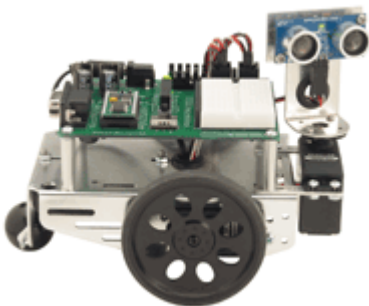
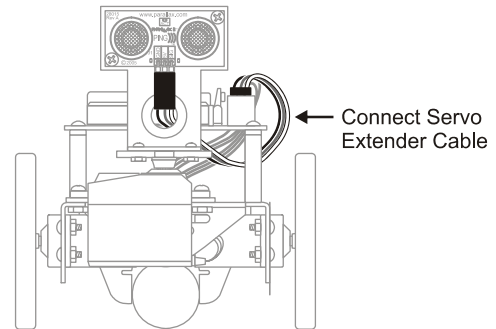

You can download sample BASIC Stamp 2 source code and videos of the Boe-Bot robot autonomously roaming with the Ping))) sensor from the 570-28015 product page at www.parallax.com