



60×60×25 mm

San Ace 60 9G type

General Specifications

- Material Frame: Plastic (Flammability: UL 94V-0), Impeller: Plastic (Flammability: UL 94V-0)
- Expected life See the table below. (L10 life: 90% survival rate for continuous operation in free air at 60°C, rated voltage)
- Motor protection function Locked rotor burnout protection, Reverse polarity protection
For details, please refer to p. 547.
- Dielectric strength 50/60 Hz, 500 VAC, for 1 minute (between lead wire conductors and frame)
- Insulation resistance 10 MΩ or more with a 500 VDC megger (between lead wire conductors and frame)
- Sound pressure level (SPL) At 1 m away from the air inlet
- Storage temperature -30 to +70°C (Non-condensing)
- Lead wire ⊕Red ⊖Black (Sensor) Yellow (Control) Brown
- Mass 90 g

Specifications

The models listed below **have ribs and pulse sensors with PWM control function.** For models without ribs, append "1" to the end of model numbers.

Model no.	Rated voltage [V]	Operating voltage range [V]	PWM duty cycle* [%]	Rated current [A]	Rated input [W]	Rated speed [min ⁻¹]	Max. airflow [m ³ /min] [CFM]	Max. static pressure [Pa] [inchH ₂ O]	SPL [dB (A)]	Operating temperature [°C]	Expected life [h]
9G0612P4S001	12	10.2 to 13.8	100	0.67	8.04	11000	1.4 49.4	300 1.2	53	-20 to +70	40000/60°C (70000/40°C)
			0	0.07	0.84	3300	0.42 14.8	27 0.11	19		
9G0612P4H001	12	10.2 to 13.8	100	0.5	6.0	9500	1.21 42.7	224 0.9	49		
			0	0.06	0.72	2850	0.36 12.7	20.2 0.08	18		
9G0624P4S001	24	20.4 to 27.6	100	0.34	8.16	11000	1.4 49.4	300 1.2	53		
			0	0.04	0.96	3300	0.42 14.8	27 0.11	19		
9G0624P4H001	24	20.4 to 27.6	100	0.25	6.0	9500	1.21 42.7	224 0.9	49		
			0	0.04	0.96	2850	0.36 12.7	20.2 0.08	18		
9G0648P4S001	48	36 to 72	100	0.18	8.64	11000	1.4 49.4	305 1.22	53		
			0	0.02	0.96	3300	0.42 14.8	27.4 0.11	19		

* PWM frequency: 25 kHz

The following sensor and control options are available for selection.

Differs according to the model. Refer to the table on pp. 567 to 568. Without sensor Pulse sensor Lock sensor

Airflow - Static Pressure Characteristics / PWM Duty - Speed Characteristics Example

9G0612P4S001 With pulse sensor with PWM control function

PWM duty cycle

Operating voltage range

PWM duty - Speed characteristics example

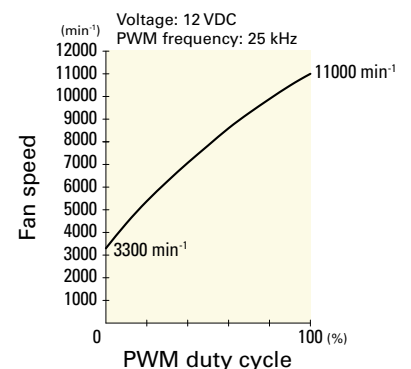
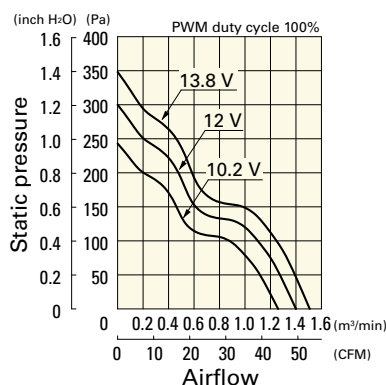
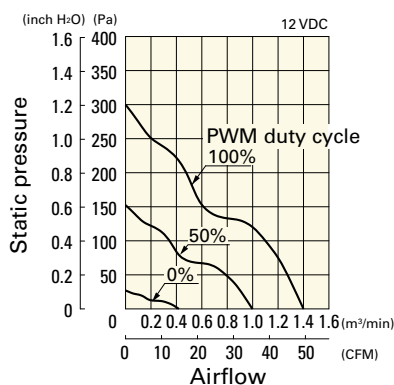

Airflow - Static Pressure Characteristics / PWM Duty - Speed Characteristics Example

9G0612P4H001 With pulse sensor with PWM control function

PWM duty cycle

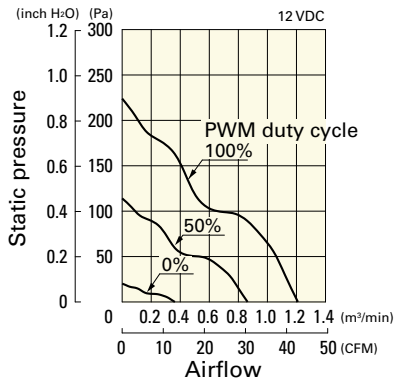

Operating voltage range

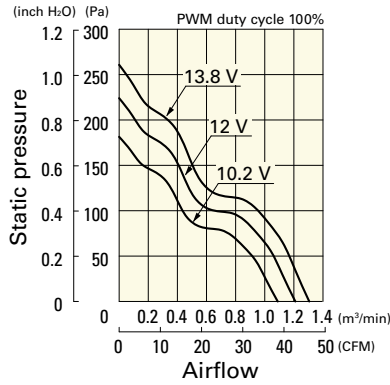

PWM duty - Speed characteristics example

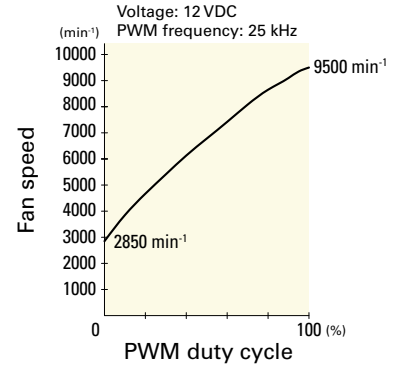

9G0624P4S001 With pulse sensor with PWM control function

PWM duty cycle

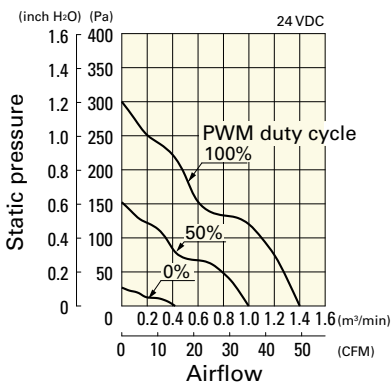

Operating voltage range

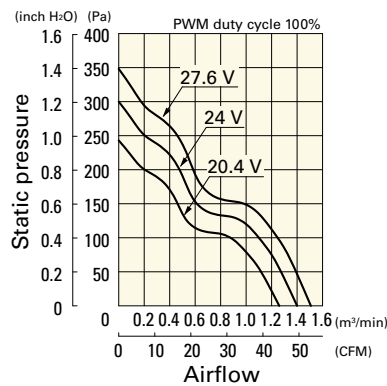

PWM duty - Speed characteristics example

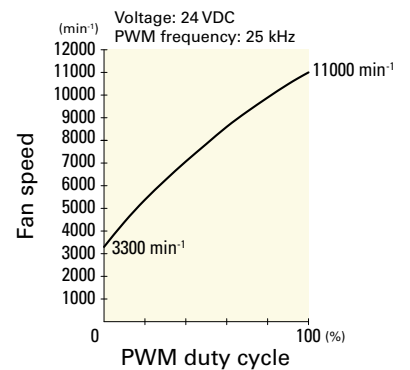

9G0624P4H001 With pulse sensor with PWM control function

PWM duty cycle

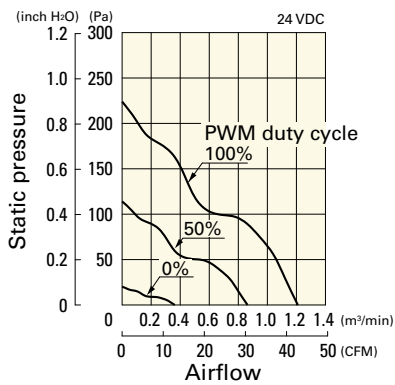

Operating voltage range

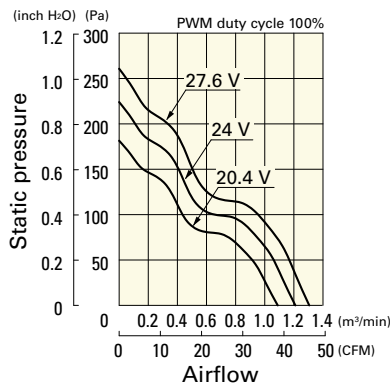

PWM duty - Speed characteristics example

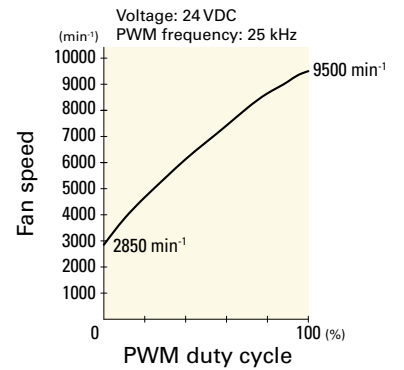

9G0648P4S001 With pulse sensor with PWM control function

PWM duty cycle

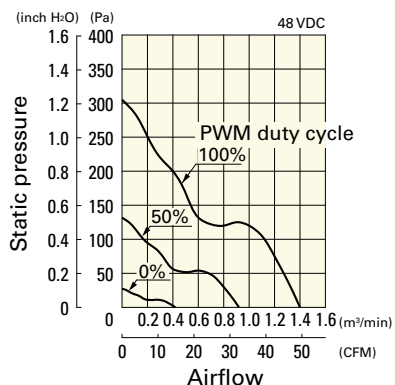

Operating voltage range

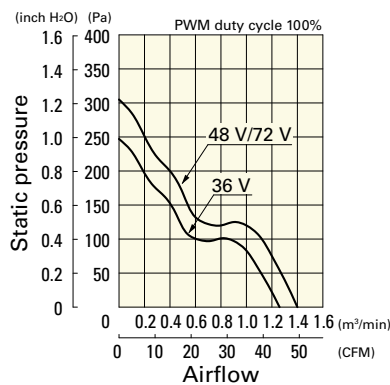

PWM duty - Speed characteristics example

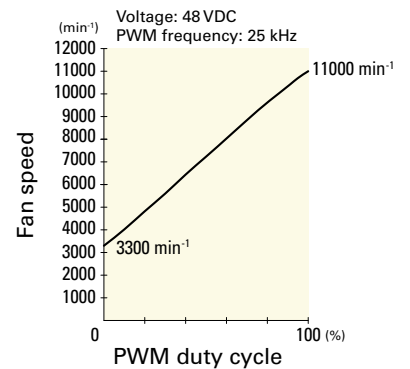

Dimensions (unit: mm) (With ribs)

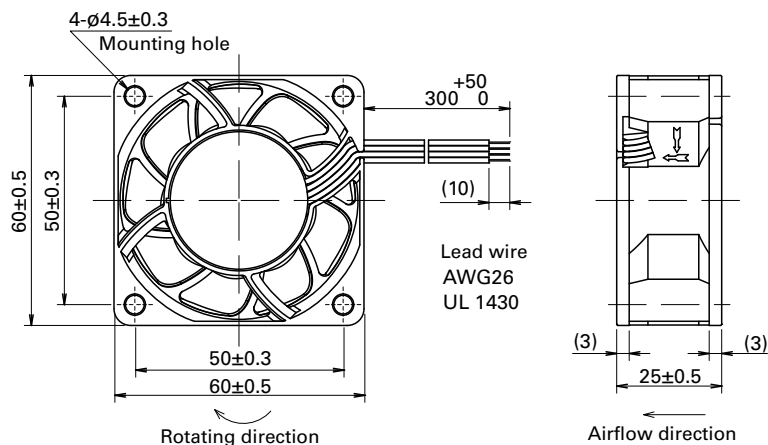

Reference Dimensions of Mounting Holes and Vent Opening (unit: mm)

Inlet side, Outlet side

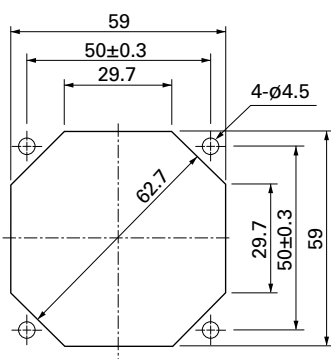

Options

Finger guards

page: p. 532

Model no.: 109-139E, 109-139H

Resin finger guards

page: p. 539

Model no.: 109-1003G

Resin filter kits

page: p. 540

Model no.: 109-1003F13 (13PPI), 109-1003F20 (20PPI),
109-1003F30 (30PPI), 109-1003F40 (40PPI)

60×60×25 mm

San Ace 60 9R type   



General Specifications

- Material Frame: Plastic (Flammability: UL 94V-0), Impeller: Plastic (Flammability: UL 94V-1)
- Expected life See the table below. (L10 life: 90% survival rate for continuous operation in free air at 60°C, rated voltage)
- Motor protection function Locked rotor burnout protection, Reverse polarity protection
For details, please refer to p. 547.
- Dielectric strength 50/60 Hz, 500 VAC, for 1 minute (between lead wire conductors and frame)
- Insulation resistance 10 MΩ or more with a 500 VDC megger (between lead wire conductors and frame)
- Sound pressure level (SPL) At 1 m away from the air inlet
- Storage temperature -30 to +70°C (Non-condensing)
- Lead wire ⊕Red ⊖Black or Blue (Sensor) Yellow
- Mass 90 g

Specifications

The models listed below **have ribs and pulse sensors**. For models without ribs, append "1" to the end of model numbers.

Model no.	Rated voltage [V]	Operating voltage range [V]	Rated current [A]	Rated input [W]	Rated speed [min ⁻¹]	Max. airflow [m ³ /min] [CFM]	Max. static pressure [Pa] [inchH ₂ O]	SPL [dB (A)]	Operating temperature [°C]	Expected life [h]		
109R0605H401	5	4.5 to 5.5	0.34	1.7	3800	0.53 18.7	40.2 0.161	28	-20 to +70	60000/60°C		
109R0605F401			0.2	1.0	3200	0.44 15.5	29.4 0.118	24	-20 to +60			
109R0605M401			0.13	0.65	2600	0.36 12.7	19.6 0.079	20	-20 to +70			
109R0612J401	12	10.8 to 13.2	0.47	5.64	7600	1.06 37.1	155.0 0.622	44	-20 to +60	40000/60°C		
109R0612G401			0.24	2.88	5600	0.78 27.5	87.3 0.351	39	-20 to +70		60000/60°C	
109R0612D401		10.2 to 13.8	0.21	2.52	5150	0.72 25.4	73.5 0.295	37				
109R0612S401			6 to 13.8	0.17	2.04	4600	0.65 23.0	56.8 0.228		33		
109R0612H401		0.11		1.32	3800	0.53 18.7	40.1 0.161	28				
109R0612F401		0.09		1.08	3200	0.44 15.5	29.4 0.118	24				
109R0612M401		7 to 13.8	0.06	0.72	2600	0.36 12.7	19.6 0.079	20				
109R0624J401		24	21.6 to 26.4	0.24	5.76	7600	1.06 37.1	155.0 0.622		44		-20 to +60
109R0624G401			20.4 to 27.6	0.13	3.12	5600	0.78 27.5	87.3 0.351	39	-20 to +70	60000/60°C	
109R0624D401	12 to 27.6		0.12	2.88	5150	0.72 25.4	73.5 0.295	37				
109R0624S401			0.08	1.92	4600	0.65 23.0	56.8 0.228	33				
109R0624H401			0.06	1.44	3800	0.53 18.7	40.2 0.161	28				
109R0624F401	0.05		1.2	3200	0.44 15.5	29.4 0.118	24					
109R0624M401	14 to 27.6		0.04	0.96	2600	0.36 12.7	19.6 0.079	20				
109R0648J401	48		43.2 to 52.8	0.12	5.76	7600	1.06 37.1	155.0 0.622	44	-20 to +60	40000/60°C	
109R0648G401		43 to 53	0.07	3.36	5600	0.78 27.5	87.3 0.351	39	-20 to +70	60000/60°C		
109R0648H401		40 to 53	0.04	1.92	3800	0.53 18.7	40.2 0.161	28				

The following sensor and control options are available for selection.

Available for all models. **Without sensor**

Differs according to the model. Refer to the table on p. 564. **Lock sensor** **PWM control**

Airflow - Static Pressure Characteristics

109R0605H401 With pulse sensor

Operating voltage range

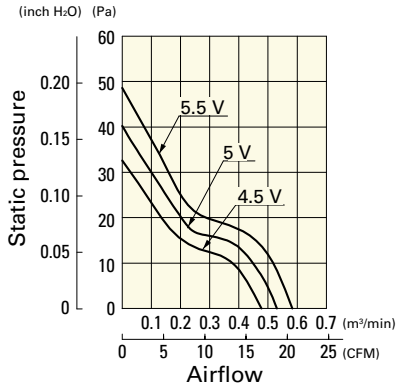

109R0605F401 With pulse sensor

Operating voltage range

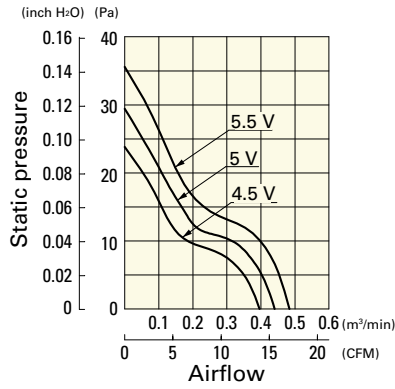

109R0605M401 With pulse sensor

Operating voltage range

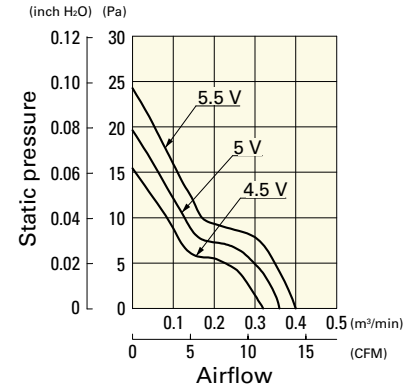

109R0612J401 With pulse sensor

Operating voltage range

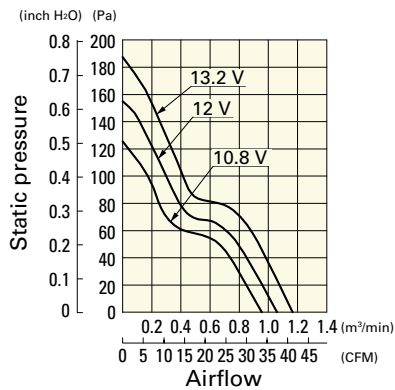

109R0612G401 With pulse sensor

Operating voltage range

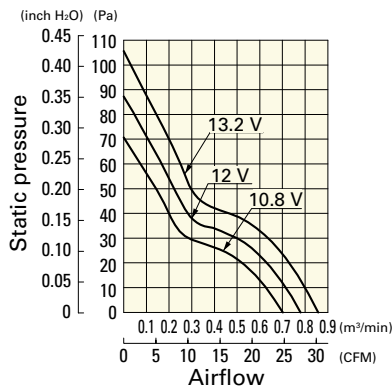

109R0612D401 With pulse sensor

Operating voltage range

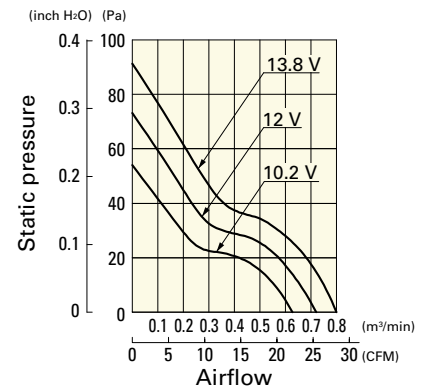

109R0612S401 With pulse sensor

Operating voltage range

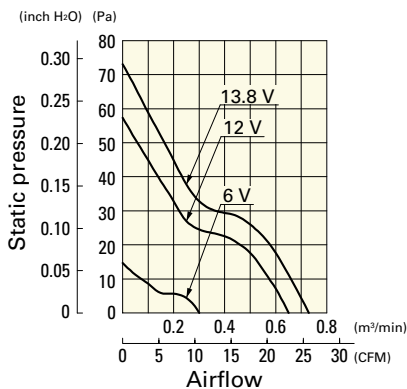

109R0612H401 With pulse sensor

Operating voltage range

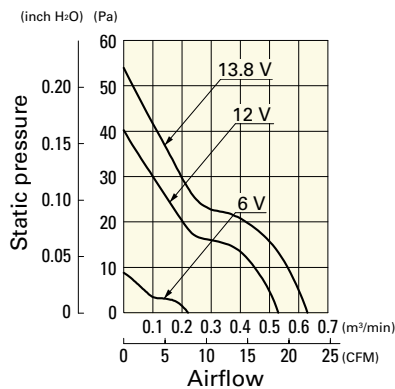

109R0612F401 With pulse sensor

Operating voltage range

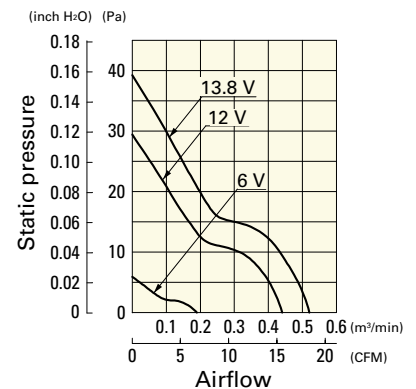

109R0612M401 With pulse sensor

Operating voltage range

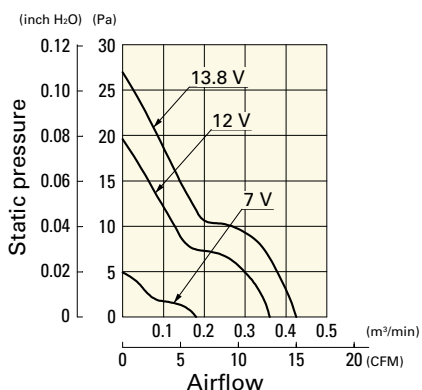

109R0624J401 With pulse sensor

Operating voltage range

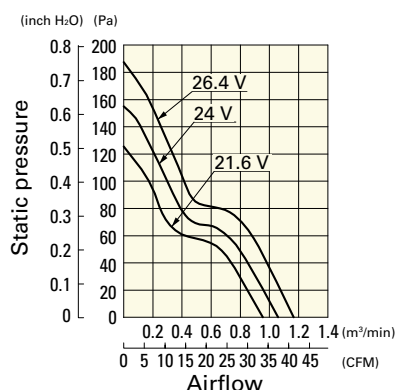

109R0624G401 With pulse sensor

Operating voltage range

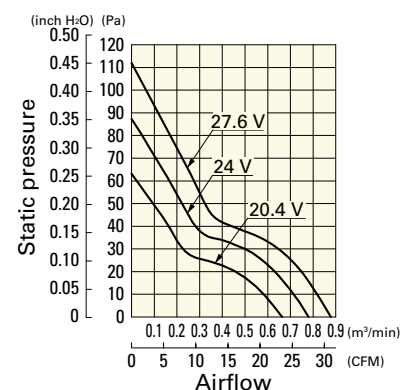

Airflow - Static Pressure Characteristics

109R0624D401 With pulse sensor

Operating voltage range

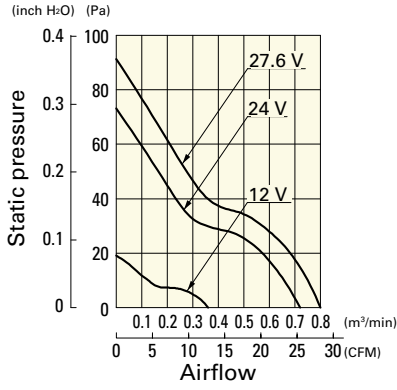

109R0624S401 With pulse sensor

Operating voltage range

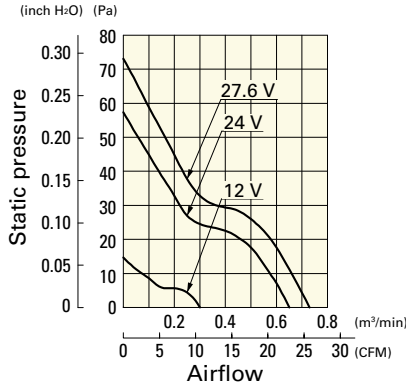

109R0624H401 With pulse sensor

Operating voltage range

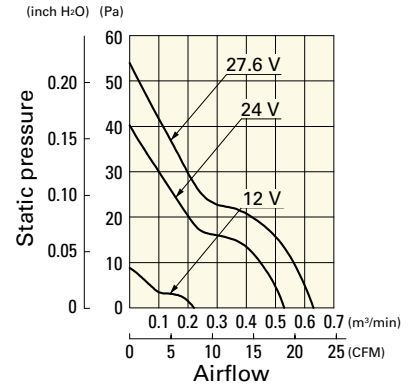

109R0624F401 With pulse sensor

Operating voltage range

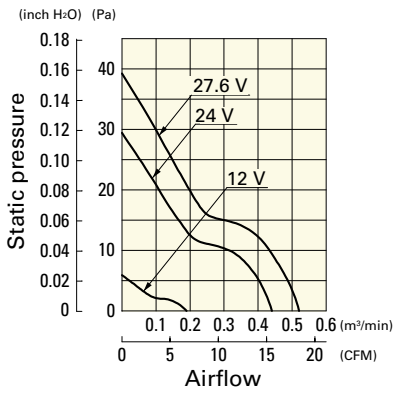

109R0624M401 With pulse sensor

Operating voltage range

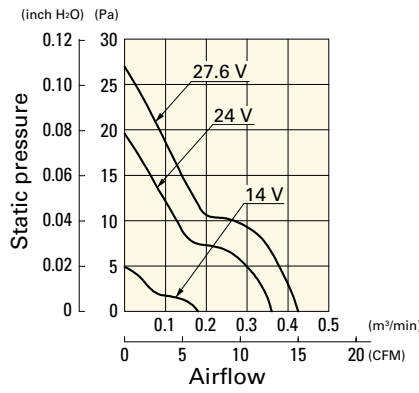

109R0648J401 With pulse sensor

Operating voltage range

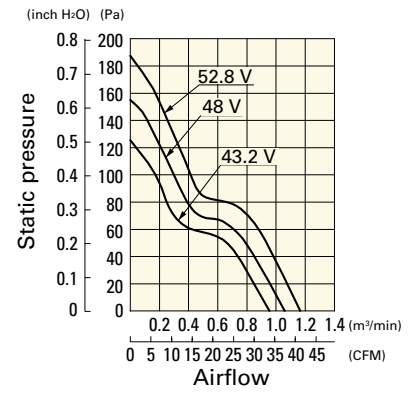

109R0648G401 With pulse sensor

Operating voltage range

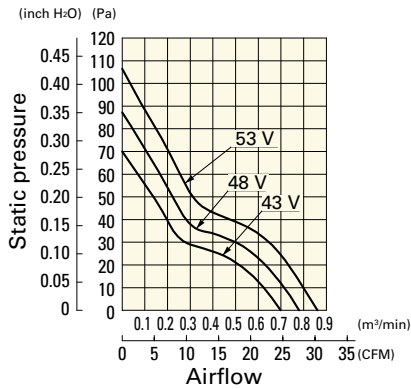

109R0648H401 With pulse sensor

Operating voltage range

