

# San Ace 92

## 9RA type

### DC Fan

#### Features

##### Low Noise and Energy Saving

Compared to our current model,<sup>(1)</sup> noise level has been more than halved<sup>(2)</sup> and power consumption has been reduced by 44%.<sup>(3)</sup>

Moreover, the models with PWM control, which enables the control of fan speed, provide further optimized noise level and efficiency.

##### Long Life

This fan lasts 2 times longer than the current model,<sup>(1)</sup> and is capable of continuous operation for 60,000 hours (approximately 7 years), improving the maintainability.

##### Rich Lineup

The product lineup is available in a wide variety in 12/24/48 voltage, cooling performance, noise level, and PWM control. This allows users to choose the most suitable one for their applications.

(1) Current model: 92 x 92 x 25 mm San Ace 92 9A type DC Fan (model: 9A0912G401).

(2) A 4 dB(A) decrease in noise level.

(3) For models 9RA0912P4G001 and 9RA0912G4001



## 92 x 92 x 25 mm

#### Specifications

The models listed below **have ribs and pulse sensors with PWM control function**. For models without ribs, append "1" to the end of model numbers.

Model no.	Rated voltage [V]	Operating voltage range [V]	PWM duty cycle* [%]	Rated current [A]	Rated input [W]	Rated speed [min <sup>-1</sup> ]	Max. airflow [m <sup>3</sup> /min] [CFM]	Max. static pressure [Pa] [inchH <sub>2</sub> O]	Noise level [dB(A)]	Operating temperature [°C]	Expected life [h]
9RA0912P4G001	12	10.8 to 13.2	100	0.22	2.64	4200	1.8 63.5	73.5 0.29	37	-20 to +70	60000/60°C (90000/40°C)
			30	0.03	0.36	1000	0.42 14.8	4.1 0.016	11		
9RA0924P4G001	24	21.6 to 26.4	100	0.13	3.12	4200	1.8 63.5	73.5 0.29	37		
			20	0.03	0.72	1000	0.42 14.8	4.1 0.016	11		
9RA0948P4G001	48	43.2 to 52.8	100	0.07	3.36	4200	1.8 63.5	73.5 0.29	37		
			20	0.03	1.44	1400	0.6 21.2	8.1 0.033	14		

\* PWM input frequency is 25 kHz; models without specifications at 0% PWM duty cycle have zero fan speed at 0%.

The models listed below **have ribs and pulse sensors**. For models without ribs, append "1" to the end of model numbers.

Model no.	Rated voltage [V]	Operating voltage range [V]	Rated current [A]	Rated input [W]	Rated speed [min <sup>-1</sup> ]	Max. airflow [m <sup>3</sup> /min] [CFM]	Max. static pressure [Pa] [inchH <sub>2</sub> O]	Noise level [dB(A)]	Operating temperature [°C]	Expected life [h]
9RA0912G4001	12	7 to 13.8	0.22	2.64	4200	1.8 63.5	73.5 0.29	37	-20 to +70	60000/60°C (90000/40°C)
9RA0912S4001			0.2	2.4	3850	1.65 58.3	61.7 0.25	35		
9RA0912H4001			0.14	1.68	3400	1.46 51.6	48.1 0.19	31		
9RA0912F4001			0.1	1.2	2850	1.22 43.1	33.8 0.14	27		
9RA0912M4001			0.07	0.84	2450	1.05 37.1	25 0.1	23		
9RA0924G4001	24	14 to 27.6	0.13	3.12	4200	1.8 63.5	73.5 0.29	37		
9RA0924S4001			0.1	2.4	3850	1.65 58.3	61.7 0.25	35		
9RA0924H4001			0.08	1.92	3400	1.46 51.6	48.1 0.19	31		
9RA0924F4001			0.06	1.44	2850	1.22 43.1	33.8 0.14	27		
9RA0924M4001			0.04	0.96	2450	1.05 37.1	25 0.1	23		
9RA0948G4001	48	36 to 55.2	0.07	3.36	4200	1.8 63.5	73.5 0.29	37		
9RA0948S4001			0.06	2.88	3850	1.65 58.3	61.7 0.25	35		
9RA0948H4001			0.05	2.4	3400	1.46 51.6	48.1 0.19	31		

Models with the following sensor specifications are also available as options: **Without sensor** **Lock sensor**

#### Common Specifications

- Material ..... Frame: Plastic (Flammability: UL 94V-0), Impeller: Plastic (Flammability: UL 94V-1)
- Expected life ..... Refer to specifications  
(L10 life: 90% survival rate for continuous operation in free air at 60°C, rated voltage)  
Expected life at 40°C is for reference only.
- Motor protection function ..... Locked rotor burnout protection, Reverse polarity protection
- Dielectric strength ..... 50/60 Hz, 500 VAC, for 1 minute (between lead wire conductors and frame)
- Insulation resistance ..... 10 MΩ or more with a 500 VDC megger (between lead wire conductors and frame)
- Noise level ..... At 1 m away from the air inlet
- Operating temperature ..... Refer to specifications (Non-condensing)
- Storage temperature ..... -30 to +70°C (Non-condensing)
- Lead wire ..... ⊕ Red ⊖ Black **Sensor** Yellow **Control** Brown
- Mass ..... 130 g

## Airflow - Static Pressure Characteristics

PWM duty cycle

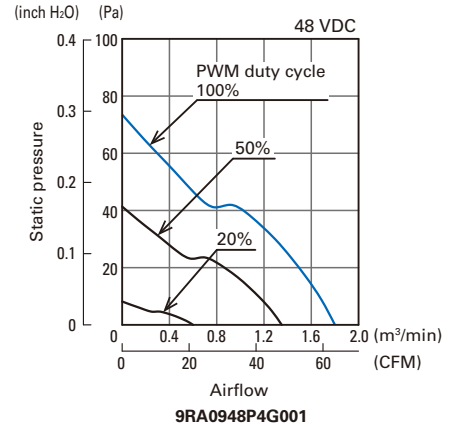
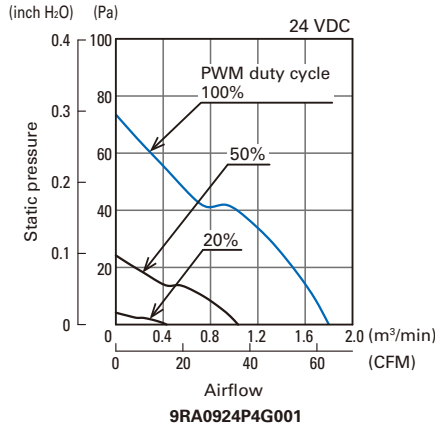
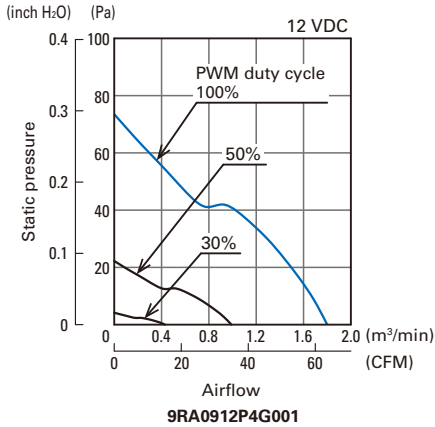

Operating voltage range

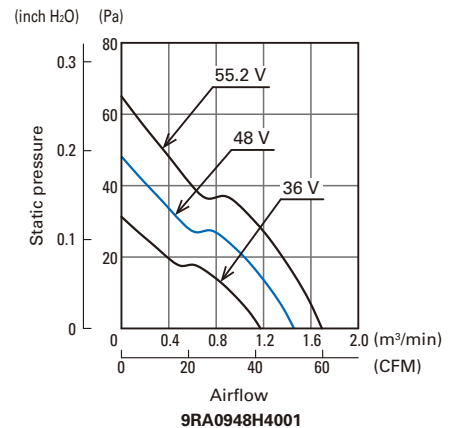
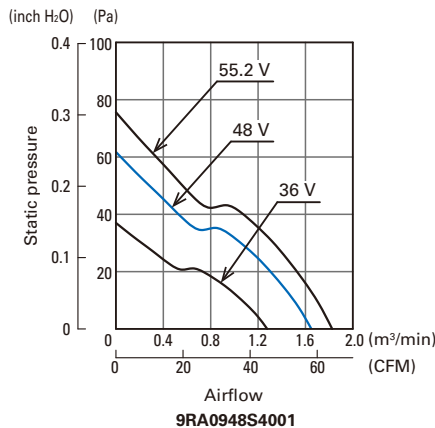
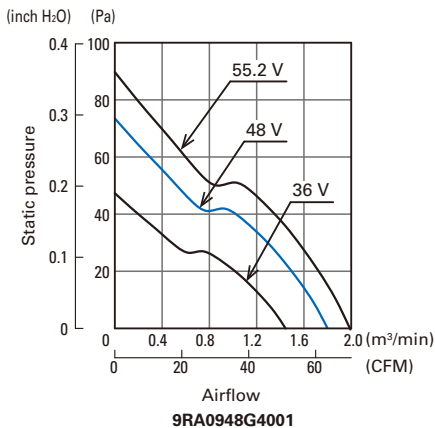
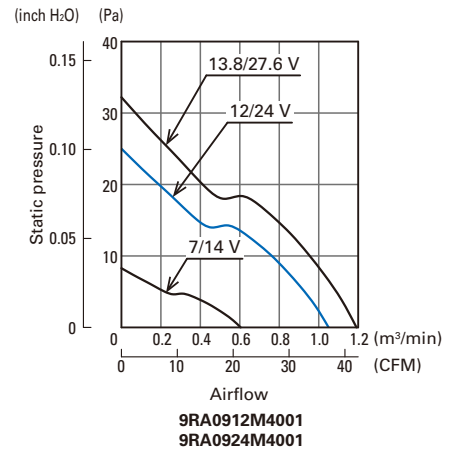
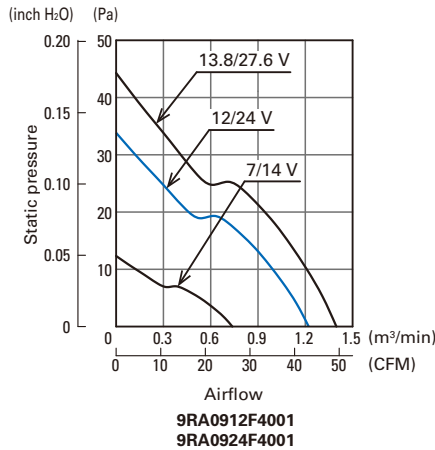
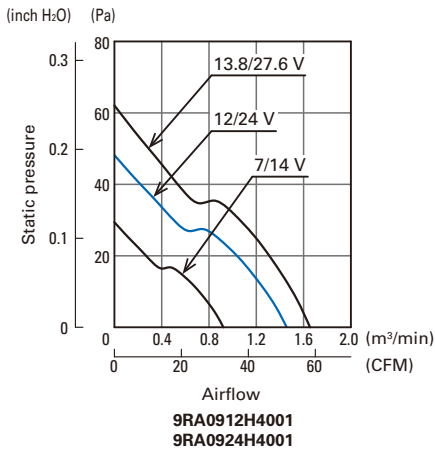
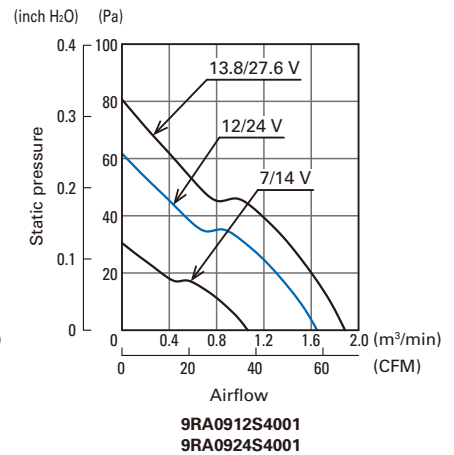
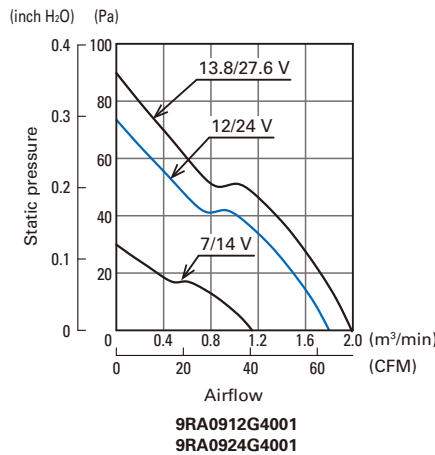
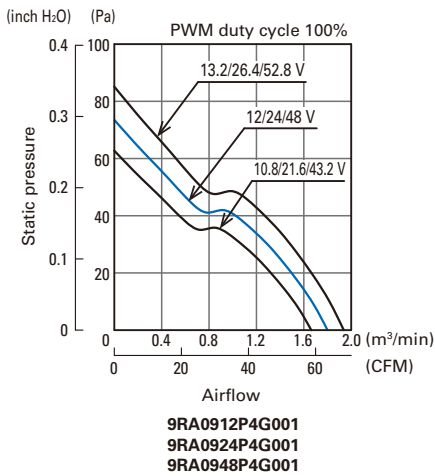

### PWM Duty - Speed Characteristics Example

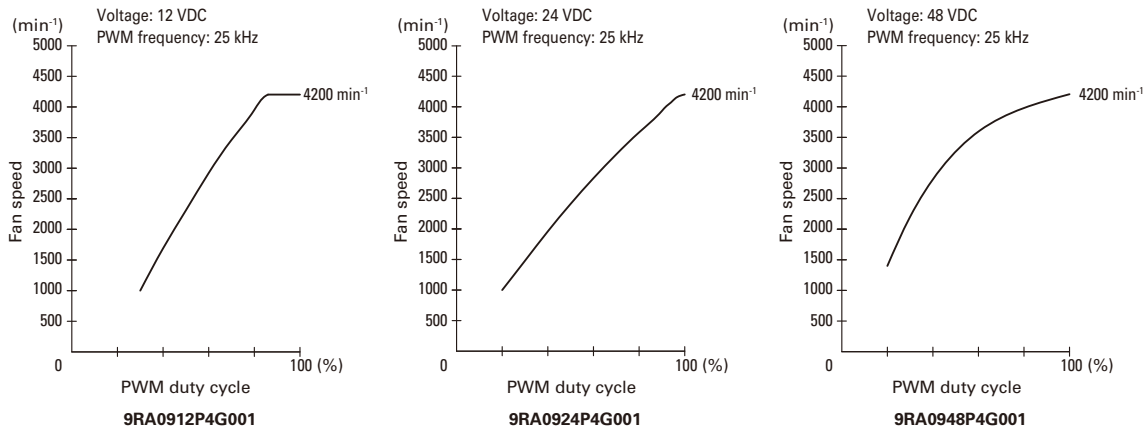

### PWM Input Signal Example

Input signal waveform

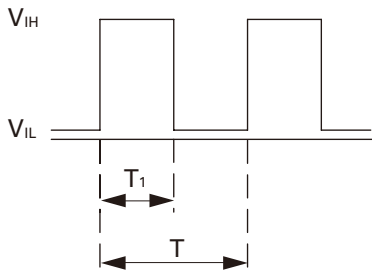

$V_{IH} = 4.75 \text{ to } 5.25 \text{ V}$     $V_{IL} = 0 \text{ to } 0.4 \text{ V}$   
 PWM duty cycle (%) =  $\frac{T_1}{T} \times 100$    PWM frequency 25 (kHz) =  $\frac{1}{T}$   
 Current source ( $I_{source}$ ) = 1.0 mA max. (when control voltage is 0 V)  
 Current sink ( $I_{sink}$ ) = 1.0 mA max. (when control voltage is 5.25 V)

When the PWM control terminal is open, the fan speed is the same as the speed at 100% PWM duty cycle. Either a TTL input or open collector/drain input can be used for the PWM input signal.

### Example of Connection Schematic

Rated voltage 12 V fan

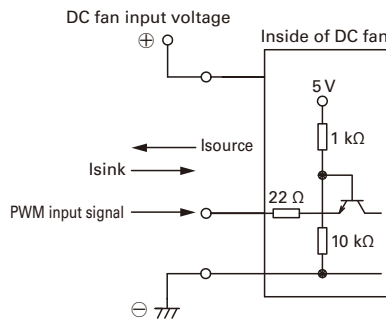

Rated voltage 24 V fan

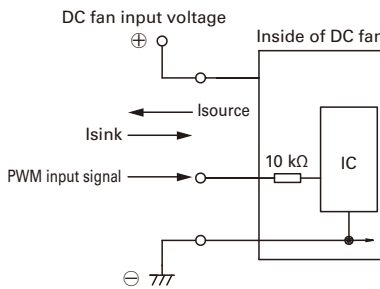

Rated voltage 48 V fan

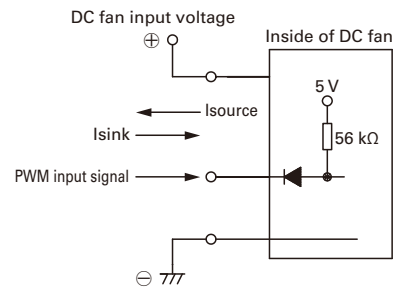

### Specifications for Pulse Sensors

Output circuit: Open collector

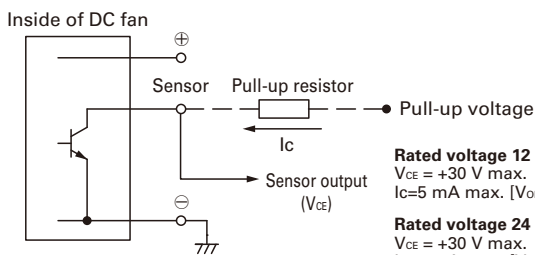

**Rated voltage 12 V fan**  
 $V_{CE} = +30 \text{ V max.}$   
 $I_C = 5 \text{ mA max.}$  [ $V_{OL} = V_{CE} \text{ (SAT)} = 0.4 \text{ V max.}$ ]

**Rated voltage 24 V fan**  
 $V_{CE} = +30 \text{ V max.}$   
 $I_C = 5 \text{ mA max.}$  [ $V_{OL} = V_{CE} \text{ (SAT)} = 1.0 \text{ V max.}$ ]

**Rated voltage 48 V fan**  
 $V_{CE} = +60 \text{ V max.}$   
 $I_C = 5 \text{ mA max.}$  [ $V_{OL} = V_{CE} \text{ (SAT)} = 0.4 \text{ V max.}$ ]

Output waveform (Need pull-up resistor)

In case of steady running

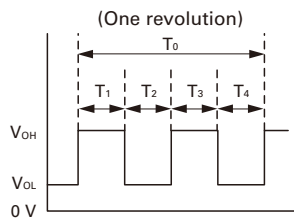

$T_{1 \text{ to } 4} \approx (1/4) T_0$   
 $T_{1 \text{ to } 4} \approx (1/4) T_0 = 60/4N \text{ (s)}$   
 $N = \text{Fan speed (min}^{-1}\text{)}$