

San Ace 120

9RA type

DC Fan

Features

Low Noise and Energy Saving

Compared to our current model,⁽¹⁾ noise level has been reduced by 3 dB(A) and power consumption has been reduced by 28%.⁽²⁾ Moreover, the models with PWM control, which enables the control of fan speed, provide further optimized noise level and efficiency.

Rich Lineup

The product lineup is available in a wide variety in 12/24/48 voltage, cooling performance, noise level, and PWM control. This allows users to choose the most suitable one for their applications.

(1) Current model: 120 x 120 x 38 mm *San Ace 120* 9G type DC Fan (model: 9G1212G101).
 (2) For models 9RA1212G1001, 9RA1224G1001, and 9RA1248G1001



120 x 120 x 38 mm

Specifications

The models listed below **have ribs and pulse sensors with PWM control function**. For models without ribs, append "1" to the end of model numbers.

| Model no. | Rated voltage [V] | Operating voltage range [V] | PWM duty cycle* [%] | Rated current [A] | Rated input [W] | Rated speed [min ⁻¹] | Max. airflow [m ³ /min] [CFM] | Max. static pressure [Pa] [inchH ₂ O] | SPL [dB(A)] | Operating temperature [°C] | Expected life [h] |
|---------------|-------------------|-----------------------------|---------------------|-------------------|-----------------|----------------------------------|--|--|-------------|----------------------------|----------------------------|
| 9RA1212P1K001 | 12 | 10.8 to 13.2 | 100 | 0.96 | 11.5 | 4700 | 4.5 158 | 170 0.683 | 50 | -20 to +70 | 30000/60°C (53000/40°C) |
| | | | 25 | 0.12 | 1.4 | 1800 | 1.7 60 | 24 0.096 | 25 | | |
| 9RA1224P1K001 | 24 | 21.6 to 26.4 | 100 | 0.48 | 11.5 | 4700 | 4.5 158 | 170 0.683 | 50 | | |
| | | | 25 | 0.06 | 1.4 | 1800 | 1.7 60 | 24 0.096 | 25 | | |
| 9RA1248P1K001 | 48 | 43.2 to 52.8 | 100 | 0.25 | 12.0 | 4700 | 4.5 158 | 170 0.683 | 50 | | |
| | | | 25 | 0.04 | 1.9 | 1500 | 1.4 50 | 17 0.069 | 21 | | |

* PWM frequency is 25 kHz. Models without ratings for 0% PWM duty cycle have zero speed at 0%. When control terminal is open, speed is the same as at 100% duty cycle.

The models listed below **have ribs and pulse sensors**. For models without ribs, append "1" to the end of model numbers.

| Model no. | Rated voltage [V] | Operating voltage range [V] | Rated current [A] | Rated input [W] | Rated speed [min ⁻¹] | Max. airflow [m ³ /min] [CFM] | Max. static pressure [Pa] [inchH ₂ O] | SPL [dB(A)] | Operating temperature [°C] | Expected life [h] |
|--------------|-------------------|-----------------------------|-------------------|-----------------|----------------------------------|--|--|-------------|----------------------------|----------------------------|
| 9RA1212G1001 | 12 | 7 to 13.8 | 0.70 | 8.4 | 4200 | 4.0 141 | 135 0.542 | 46 | -20 to +70 | 40000/60°C (70000/40°C) |
| 9RA1212E1001 | | | 0.47 | 5.6 | 3600 | 3.4 120 | 100 0.402 | 43 | | |
| 9RA1212H1001 | | | 0.25 | 3.0 | 3000 | 2.8 99 | 70 0.281 | 37 | | |
| 9RA1224G1001 | 24 | 14 to 27.6 | 0.35 | 8.4 | 4200 | 4.0 141 | 135 0.542 | 46 | | |
| 9RA1224E1001 | | | 0.24 | 5.8 | 3600 | 3.4 120 | 100 0.402 | 43 | | |
| 9RA1224H1001 | | | 0.13 | 3.1 | 3000 | 2.8 99 | 70 0.281 | 37 | | |
| 9RA1248G1001 | 48 | 40.8 to 55.2 | 0.18 | 8.6 | 4200 | 4.0 141 | 135 0.542 | 46 | | |
| 9RA1248E1001 | | | 0.12 | 5.8 | 3600 | 3.4 120 | 100 0.402 | 43 | | |
| 9RA1248H1001 | | | 0.07 | 3.4 | 3000 | 2.8 99 | 70 0.281 | 37 | | |

Models with the following sensor specifications are also available as options: **Without sensor** **Lock sensor**

Common Specifications

- Material Frame: Plastic (Flammability: UL 94V-0), Impeller: Plastic (Flammability: UL 94V-0)
- Expected life Refer to specifications
(L10 life: 90% survival rate for continuous operation in free air at 60°C, rated voltage)
Expected life at 40°C is for reference only.
- Motor protection function Locked rotor burnout protection, Reverse polarity protection
- Dielectric strength 50/60 Hz, 500 VAC, for 1 minute (between lead wire conductors and frame)
- Insulation resistance 10 MΩ min. at 500 VDC (between lead wire conductors and frame)
- Sound pressure level (SPL) A-weighted sound pressure level (SPL) at 1 m away from the air inlet.
- Operating temperature Refer to specifications (Non-condensing)
- Storage temperature -30 to +70°C (Non-condensing)
- Lead wire ⊕ Red ⊖ Black (Sensor) Yellow (Control) Brown
(For models without PWM control function, there is no speed control wiring.)
- Mass 320 g

Airflow - Static Pressure Characteristics

PWM duty cycle

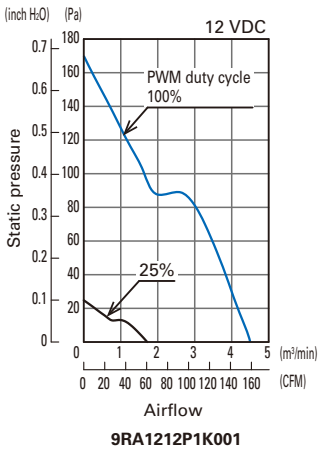

Operating voltage range

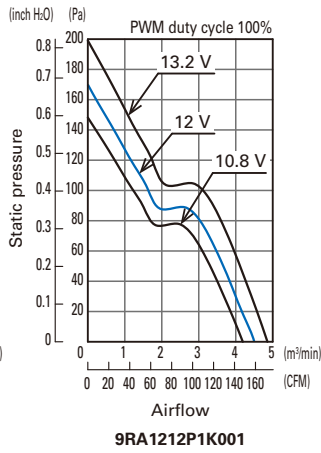

PWM duty cycle

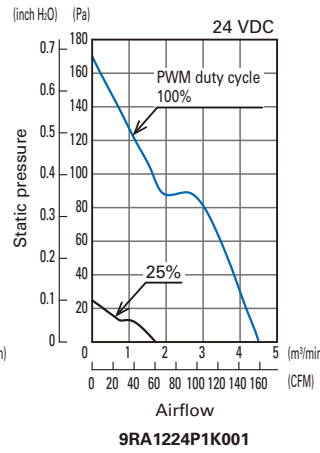

Operating voltage range

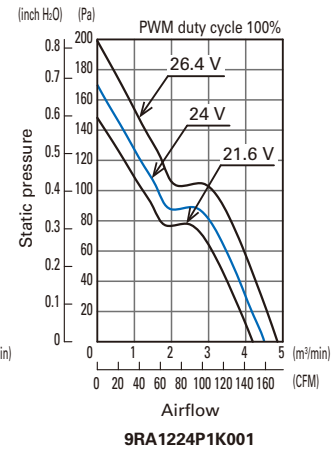

PWM duty cycle

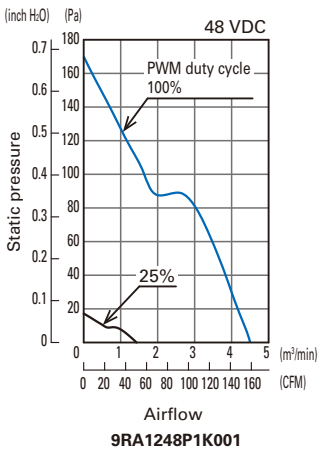

Operating voltage range

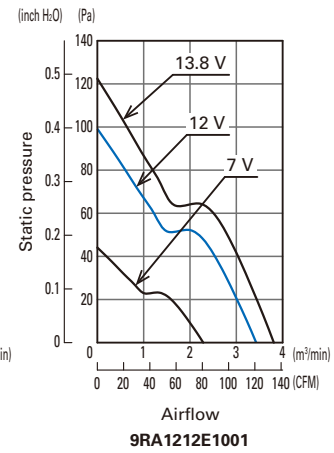
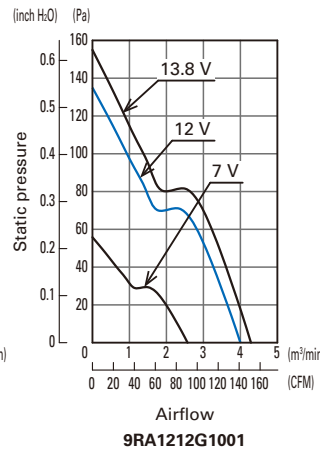
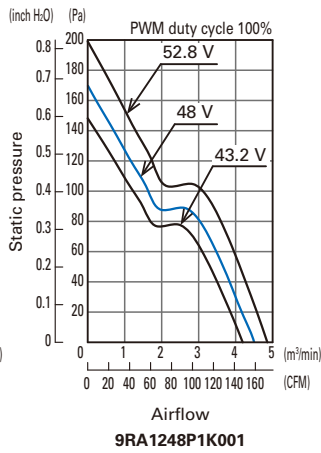

Operating voltage range

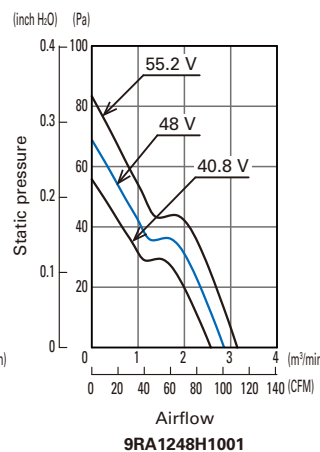
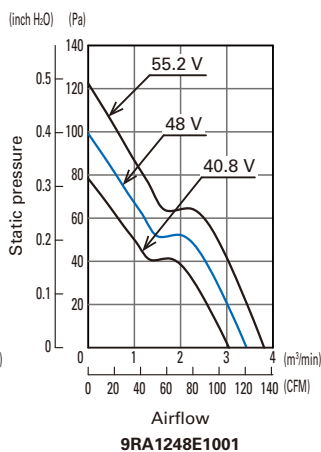
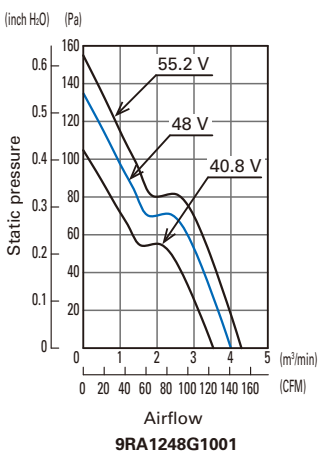
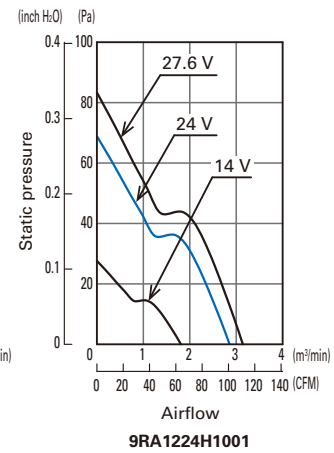
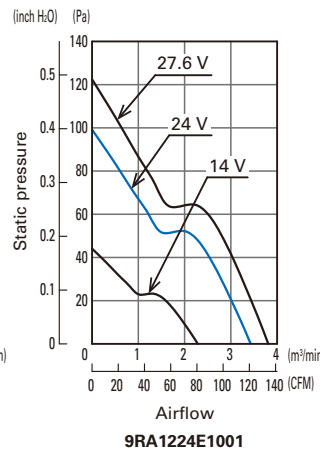
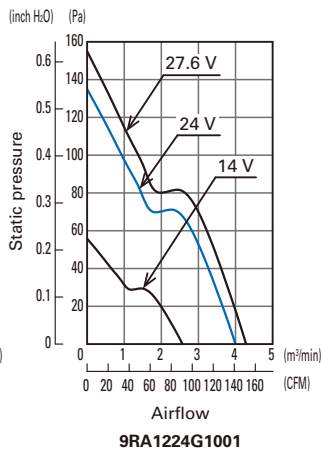
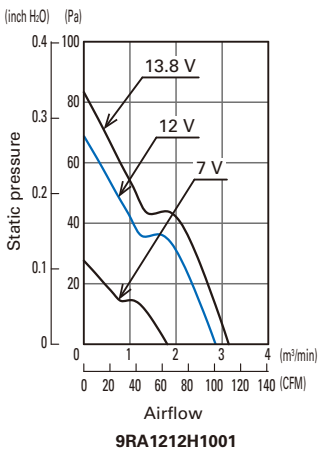

PWM Duty - Speed Characteristics Example

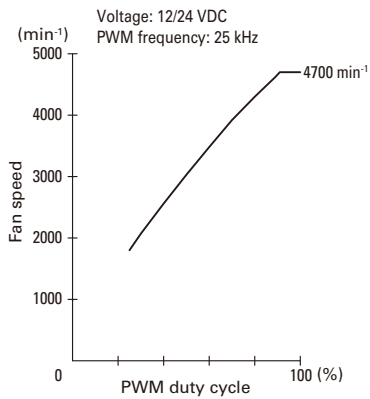

9RA1212P1K001
9RA1224P1K001

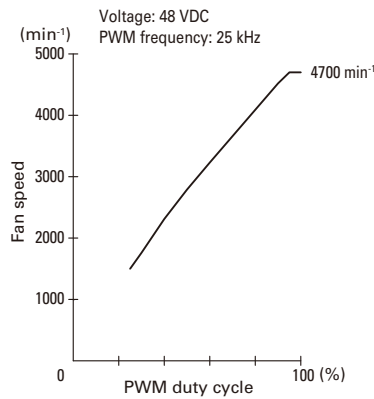

9RA1248P1K001

PWM Input Signal Example

Input signal waveform

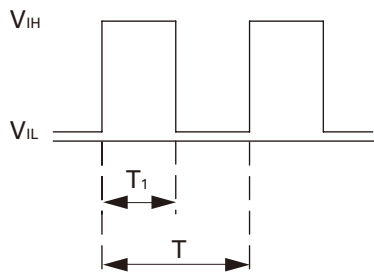

$V_{IH} = 4.75 \text{ to } 5.25 \text{ V}$ $V_{IL} = 0 \text{ to } 0.4 \text{ V}$

PWM duty cycle (%) = $\frac{T_1}{T} \times 100$ PWM frequency 25 (kHz) = $\frac{1}{T}$

Current source (I_{source}) = 1.0 mA max. (when control voltage is 0 V)

Current sink (I_{sink}) = 1.0 mA max. (when control voltage is 5.25 V)

When the PWM control terminal is open,

the fan speed is the same as the speed at 100% PWM duty cycle.

The PWM signal can be used with open collector or drain input.

Note that when using an open collector or drain input,

or inputting a different voltage or frequency,

the speed relative to the PWM duty cycle may differ from this specification.

Example of Connection Schematic

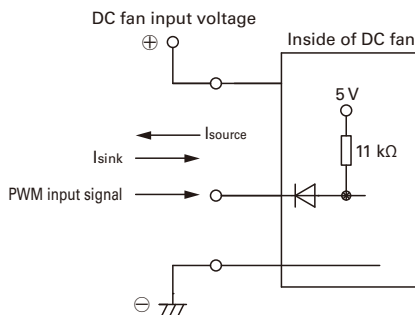

Specifications for Pulse Sensors

Output circuit: Open collector

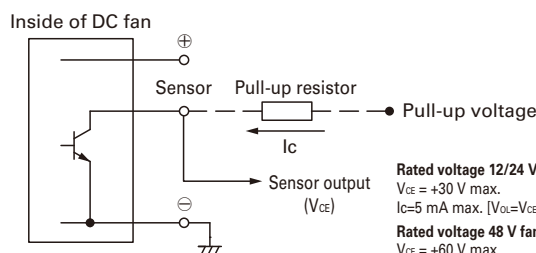

Rated voltage 12/24 V fan (With PWM control function)
 $V_{CE} = +30 \text{ V max.}$
 $I_C = 5 \text{ mA max.}$ [$V_{OL} = V_{CE} \text{ (SAT)} = 0.6 \text{ V max.}$]

Rated voltage 48 V fan (With PWM control function)
 $V_{CE} = +60 \text{ V max.}$
 $I_C = 5 \text{ mA max.}$ [$V_{OL} = V_{CE} \text{ (SAT)} = 0.6 \text{ V max.}$]

Rated voltage 12/24 V fan (Without PWM control function)
 $V_{CE} = +30 \text{ V max.}$
 $I_C = 10 \text{ mA max.}$ [$V_{OL} = V_{CE} \text{ (SAT)} = 0.4 \text{ V max.}$]

Rated voltage 48 V fan (Without PWM control function)
 $V_{CE} = +60 \text{ V max.}$
 $I_C = 10 \text{ mA max.}$ [$V_{OL} = V_{CE} \text{ (SAT)} = 0.4 \text{ V max.}$]

Output waveform (Need pull-up resistor)

In case of steady running

(One revolution)

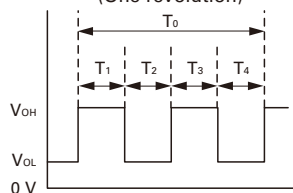

$T_{1 \text{ to } 4} \approx (1/4) T_0$

$T_{1 \text{ to } 4} \approx (1/4) T_0 = 60/4N \text{ (s)}$

$N = \text{Fan speed (min}^{-1}\text{)}$