

San Ace 120

9RA type

DC Fan

Features

Low Noise and Energy Saving

Compared to our current model,⁽¹⁾ noise level has been reduced by 3 dB(A) and power consumption has been reduced by 28%.⁽²⁾ Moreover, the models with PWM control, which enables the control of fan speed, provide further optimized noise level and efficiency.

Rich Lineup

The product lineup is available in a wide variety in 12/24/48 voltage, cooling performance, noise level, and PWM control. This allows users to choose the most suitable one for their applications.

(1) Current model: 120 x 120 x 38 mm *San Ace 120* 9G type DC Fan (model: 9G1212G101).
 (2) For models 9RA1212G1001, 9RA1224G1001, and 9RA1248G1001



120 x 120 x 38 mm

Specifications

The models listed below **have ribs and pulse sensors with PWM control function**. For models without ribs, append "1" to the end of model numbers.

| Model no. | Rated voltage [V] | Operating voltage range [V] | PWM duty cycle* [%] | Rated current [A] | Rated input [W] | Rated speed [min ⁻¹] | Max. airflow [m ³ /min] [CFM] | Max. static pressure [Pa] [inchH ₂ O] | SPL [dB(A)] | Operating temperature [°C] | Expected life [h] |
|---------------|-------------------|-----------------------------|---------------------|-------------------|-----------------|----------------------------------|------------------------------------------|--------------------------------------------------|-------------|----------------------------|----------------------------|
| 9RA1212P1K001 | 12 | 10.8 to 13.2 | 100 | 0.96 | 11.5 | 4700 | 4.5 158 | 170 0.683 | 50 | -20 to +70 | 30000/60°C (53000/40°C) |
| | | | 25 | 0.12 | 1.4 | 1800 | 1.7 60 | 24 0.096 | 25 | | |
| 9RA1224P1K001 | 24 | 21.6 to 26.4 | 100 | 0.48 | 11.5 | 4700 | 4.5 158 | 170 0.683 | 50 | | |
| | | | 25 | 0.06 | 1.4 | 1800 | 1.7 60 | 24 0.096 | 25 | | |
| 9RA1248P1K001 | 48 | 43.2 to 52.8 | 100 | 0.25 | 12.0 | 4700 | 4.5 158 | 170 0.683 | 50 | | |
| | | | 25 | 0.04 | 1.9 | 1500 | 1.4 50 | 17 0.069 | 21 | | |

* PWM frequency is 25 kHz. Models without ratings for 0% PWM duty cycle have zero speed at 0%. When control terminal is open, speed is the same as at 100% duty cycle.

The models listed below **have ribs and pulse sensors**. For models without ribs, append "1" to the end of model numbers.

| Model no. | Rated voltage [V] | Operating voltage range [V] | Rated current [A] | Rated input [W] | Rated speed [min ⁻¹] | Max. airflow [m ³ /min] [CFM] | Max. static pressure [Pa] [inchH ₂ O] | SPL [dB(A)] | Operating temperature [°C] | Expected life [h] |
|--------------|-------------------|-----------------------------|-------------------|-----------------|----------------------------------|------------------------------------------|--------------------------------------------------|-------------|----------------------------|----------------------------|
| 9RA1212G1001 | 12 | 7 to 13.8 | 0.70 | 8.4 | 4200 | 4.0 141 | 135 0.542 | 46 | -20 to +70 | 40000/60°C (70000/40°C) |
| 9RA1212E1001 | | | 0.47 | 5.6 | 3600 | 3.4 120 | 100 0.402 | 43 | | |
| 9RA1212H1001 | | | 0.25 | 3.0 | 3000 | 2.8 99 | 70 0.281 | 37 | | |
| 9RA1224G1001 | 24 | 14 to 27.6 | 0.35 | 8.4 | 4200 | 4.0 141 | 135 0.542 | 46 | | |
| 9RA1224E1001 | | | 0.24 | 5.8 | 3600 | 3.4 120 | 100 0.402 | 43 | | |
| 9RA1224H1001 | | | 0.13 | 3.1 | 3000 | 2.8 99 | 70 0.281 | 37 | | |
| 9RA1248G1001 | 48 | 40.8 to 55.2 | 0.18 | 8.6 | 4200 | 4.0 141 | 135 0.542 | 46 | | |
| 9RA1248E1001 | | | 0.12 | 5.8 | 3600 | 3.4 120 | 100 0.402 | 43 | | |
| 9RA1248H1001 | | | 0.07 | 3.4 | 3000 | 2.8 99 | 70 0.281 | 37 | | |

Models with the following sensor specifications are also available as options: **Without sensor** **Lock sensor**

Common Specifications

- Material Frame: Plastic (Flammability: UL 94V-0), Impeller: Plastic (Flammability: UL 94V-0)
- Expected life Refer to specifications
(L10 life: 90% survival rate for continuous operation in free air at 60°C, rated voltage)
Expected life at 40°C is for reference only.
- Motor protection function Locked rotor burnout protection, Reverse polarity protection
- Dielectric strength 50/60 Hz, 500 VAC, for 1 minute (between lead wire conductors and frame)
- Insulation resistance 10 MΩ min. at 500 VDC (between lead wire conductors and frame)
- Sound pressure level (SPL) A-weighted sound pressure level (SPL) at 1 m away from the air inlet.
- Operating temperature Refer to specifications (Non-condensing)
- Storage temperature -30 to +70°C (Non-condensing)
- Lead wire ⊕ Red ⊖ Black **Sensor** Yellow **Control** Brown
(For models without PWM control function, there is no speed control wiring.)
- Mass 320 g

Airflow - Static Pressure Characteristics

PWM duty cycle

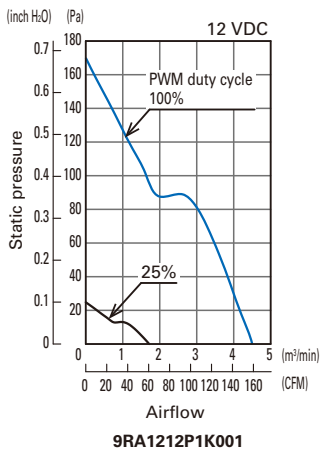

9RA1212P1K001

Operating voltage range

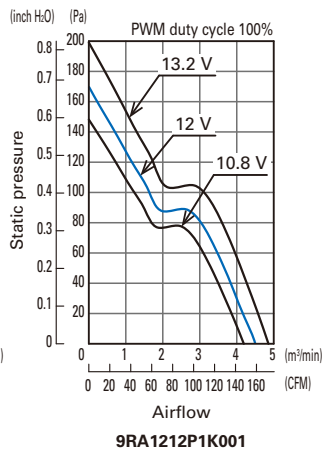

9RA1212P1K001

PWM duty cycle

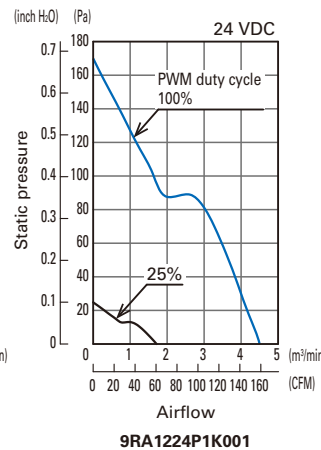

9RA1224P1K001

Operating voltage range

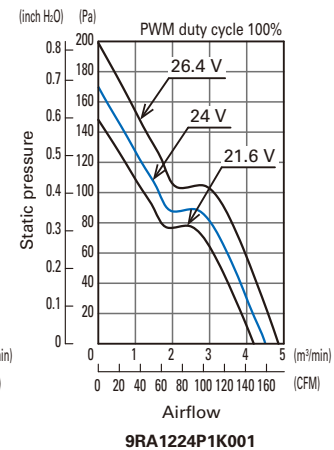

9RA1224P1K001

PWM duty cycle

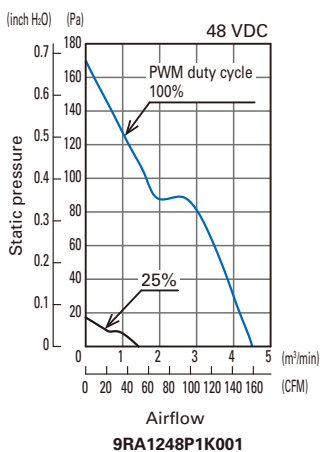

9RA1248P1K001

Operating voltage range

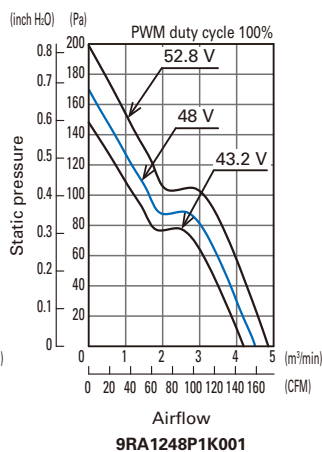

9RA1248P1K001

Operating voltage range

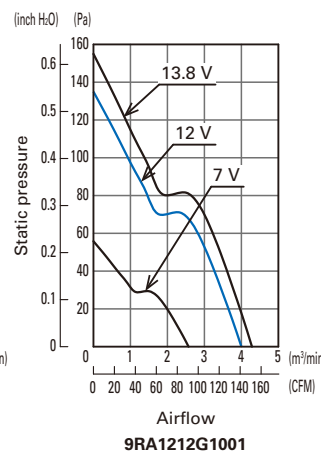

9RA1212G1001

Operating voltage range

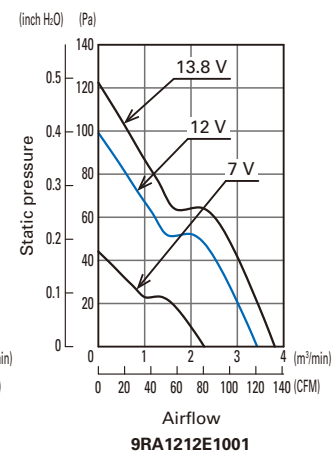

9RA1212E1001

Operating voltage range

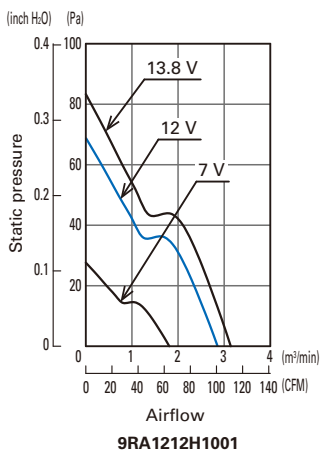

9RA1212H1001

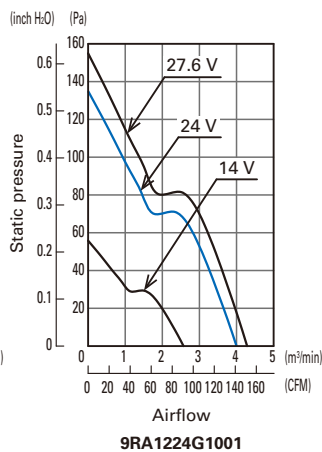

9RA1224G1001

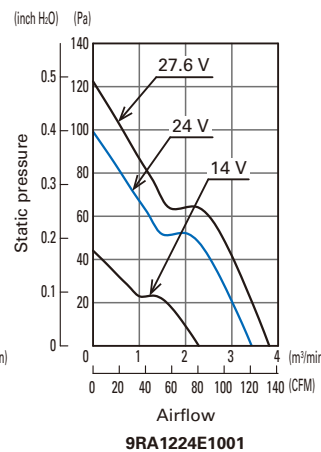

9RA1224E1001

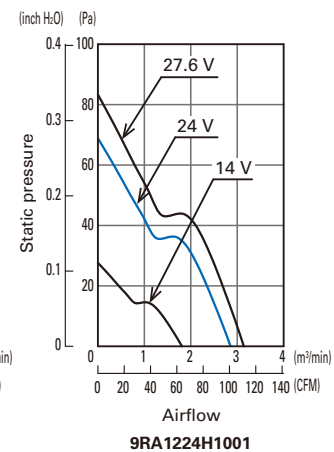

9RA1224H1001

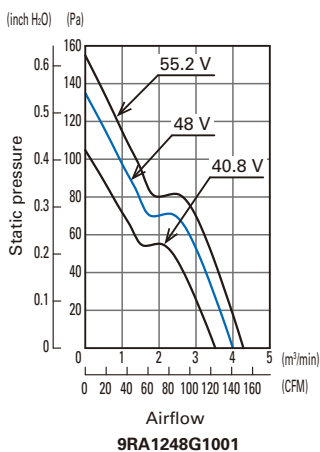

9RA1248G1001

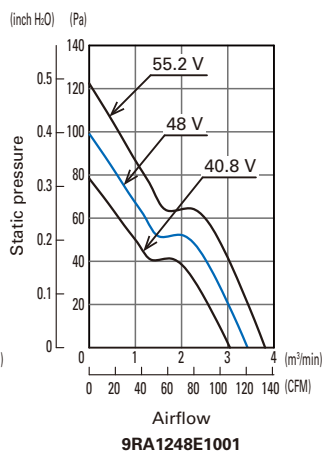

9RA1248E1001

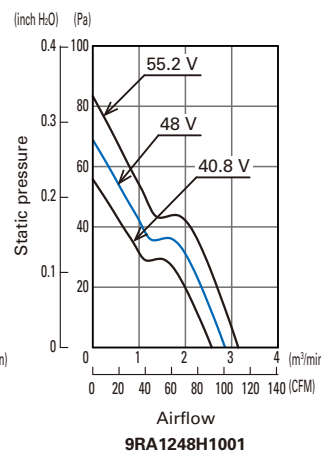

9RA1248H1001

PWM Duty - Speed Characteristics Example

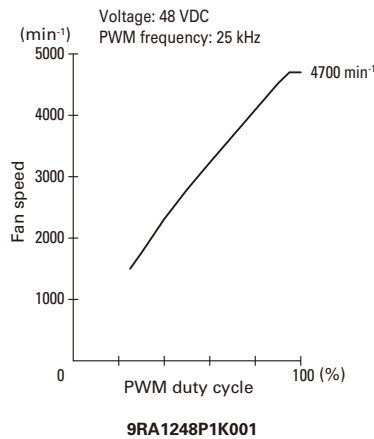
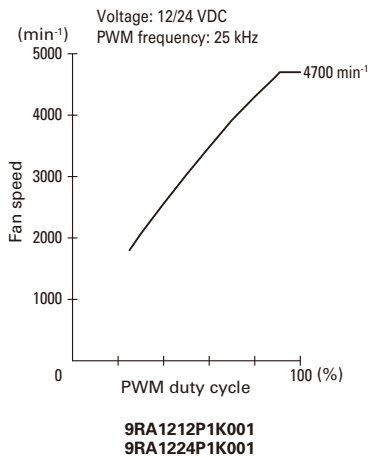

PWM Input Signal Example

Input signal waveform

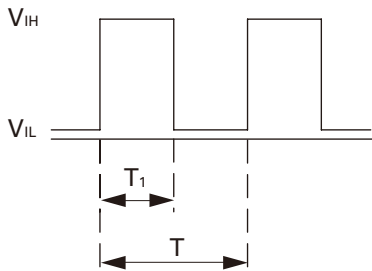

$V_{IH} = 4.75 \text{ to } 5.25 \text{ V}$ $V_{IL} = 0 \text{ to } 0.4 \text{ V}$

PWM duty cycle (%) = $\frac{T_1}{T} \times 100$ PWM frequency 25 (kHz) = $\frac{1}{T}$

Current source (I_{source}) = 1.0 mA max. (when control voltage is 0 V)

Current sink (I_{sink}) = 1.0 mA max. (when control voltage is 5.25 V)

When the PWM control terminal is open,

the fan speed is the same as the speed at 100% PWM duty cycle.

The PWM signal can be used with open collector or drain input.

Note that when using an open collector or drain input,

or inputting a different voltage or frequency,

the speed relative to the PWM duty cycle may differ from this specification.

Example of Connection Schematic

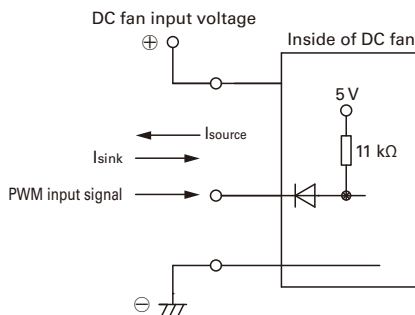

Specifications for Pulse Sensors

Output circuit: Open collector

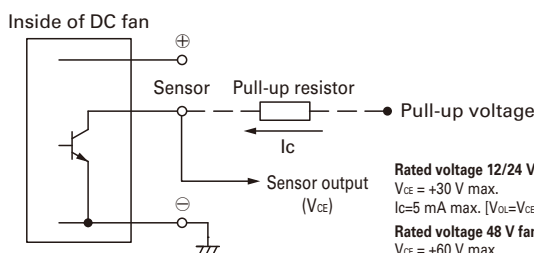

Rated voltage 12/24 V fan (With PWM control function)
 $V_{CE} = +30 \text{ V max.}$
 $I_C = 5 \text{ mA max.}$ [$V_{OL} = V_{CE} \text{ (SAT)} = 0.6 \text{ V max.}$]

Rated voltage 48 V fan (With PWM control function)
 $V_{CE} = +60 \text{ V max.}$
 $I_C = 5 \text{ mA max.}$ [$V_{OL} = V_{CE} \text{ (SAT)} = 0.6 \text{ V max.}$]

Rated voltage 12/24 V fan (Without PWM control function)
 $V_{CE} = +30 \text{ V max.}$
 $I_C = 10 \text{ mA max.}$ [$V_{OL} = V_{CE} \text{ (SAT)} = 0.4 \text{ V max.}$]

Rated voltage 48 V fan (Without PWM control function)
 $V_{CE} = +60 \text{ V max.}$
 $I_C = 10 \text{ mA max.}$ [$V_{OL} = V_{CE} \text{ (SAT)} = 0.4 \text{ V max.}$]

Output waveform (Need pull-up resistor)

In case of steady running

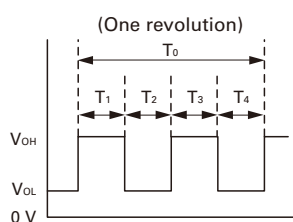

$T_{1 \text{ to } 4} \approx (1/4) T_0$

$T_{1 \text{ to } 4} \approx (1/4) T_0 = 60/4N \text{ (s)}$

$N = \text{Fan speed (min}^{-1}\text{)}$