

# San Ace 120

## 9RA type

### DC Fan

#### Features

##### Low Noise and Energy Saving

Compared to our current model,<sup>(1)</sup> noise level has been reduced by 3 dB(A) and power consumption has been reduced by 28%.<sup>(2)</sup> Moreover, the models with PWM control, which enables the control of fan speed, provide further optimized noise level and efficiency.

##### Rich Lineup

The product lineup is available in a wide variety in 12/24/48 voltage, cooling performance, noise level, and PWM control. This allows users to choose the most suitable one for their applications.

(1) Current model: 120 x 120 x 38 mm *San Ace 120* 9G type DC Fan (model: 9G1212G101).  
 (2) For models 9RA1212G1001, 9RA1224G1001, and 9RA1248G1001



## 120 x 120 x 38 mm

#### Specifications

The models listed below **have ribs and pulse sensors with PWM control function**. For models without ribs, append "1" to the end of model numbers.

Model no.	Rated voltage [V]	Operating voltage range [V]	PWM duty cycle* [%]	Rated current [A]	Rated input [W]	Rated speed [min <sup>-1</sup> ]	Max. airflow [m <sup>3</sup> /min] [CFM]	Max. static pressure [Pa] [inchH <sub>2</sub> O]	SPL [dB(A)]	Operating temperature [°C]	Expected life [h]
9RA1212P1K001	12	10.8 to 13.2	100	0.96	11.5	4700	4.5 158	170 0.683	50	-20 to +70	30000/60°C (53000/40°C)
			25	0.12	1.4	1800	1.7 60	24 0.096	25		
9RA1224P1K001	24	21.6 to 26.4	100	0.48	11.5	4700	4.5 158	170 0.683	50		
			25	0.06	1.4	1800	1.7 60	24 0.096	25		
9RA1248P1K001	48	43.2 to 52.8	100	0.25	12.0	4700	4.5 158	170 0.683	50		
			25	0.04	1.9	1500	1.4 50	17 0.069	21		

\* PWM frequency is 25 kHz. Models without ratings for 0% PWM duty cycle have zero speed at 0%. When control terminal is open, speed is the same as at 100% duty cycle.

The models listed below **have ribs and pulse sensors**. For models without ribs, append "1" to the end of model numbers.

Model no.	Rated voltage [V]	Operating voltage range [V]	Rated current [A]	Rated input [W]	Rated speed [min <sup>-1</sup> ]	Max. airflow [m <sup>3</sup> /min] [CFM]	Max. static pressure [Pa] [inchH <sub>2</sub> O]	SPL [dB(A)]	Operating temperature [°C]	Expected life [h]
9RA1212G1001	12	7 to 13.8	0.70	8.4	4200	4.0 141	135 0.542	46	-20 to +70	40000/60°C (70000/40°C)
9RA1212E1001			0.47	5.6	3600	3.4 120	100 0.402	43		
9RA1212H1001			0.25	3.0	3000	2.8 99	70 0.281	37		
9RA1224G1001	24	14 to 27.6	0.35	8.4	4200	4.0 141	135 0.542	46		
9RA1224E1001			0.24	5.8	3600	3.4 120	100 0.402	43		
9RA1224H1001			0.13	3.1	3000	2.8 99	70 0.281	37		
9RA1248G1001	48	40.8 to 55.2	0.18	8.6	4200	4.0 141	135 0.542	46		
9RA1248E1001			0.12	5.8	3600	3.4 120	100 0.402	43		
9RA1248H1001			0.07	3.4	3000	2.8 99	70 0.281	37		

Models with the following sensor specifications are also available as options: **Without sensor** **Lock sensor**

#### Common Specifications

- Material ..... Frame: Plastic (Flammability: UL 94V-0), Impeller: Plastic (Flammability: UL 94V-0)
- Expected life ..... Refer to specifications  
(L10 life: 90% survival rate for continuous operation in free air at 60°C, rated voltage)  
Expected life at 40°C is for reference only.
- Motor protection function ..... Locked rotor burnout protection, Reverse polarity protection
- Dielectric strength ..... 50/60 Hz, 500 VAC, for 1 minute (between lead wire conductors and frame)
- Insulation resistance ..... 10 MΩ min. at 500 VDC (between lead wire conductors and frame)
- Sound pressure level (SPL) ..... A-weighted sound pressure level (SPL) at 1 m away from the air inlet.
- Operating temperature ..... Refer to specifications (Non-condensing)
- Storage temperature ..... -30 to +70°C (Non-condensing)
- Lead wire ..... ⊕ Red ⊖ Black (Sensor) Yellow (Control) Brown  
(For models without PWM control function, there is no speed control wiring.)
- Mass ..... 320 g

## Airflow - Static Pressure Characteristics

PWM duty cycle

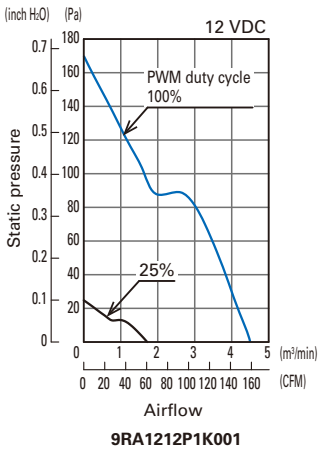

Operating voltage range

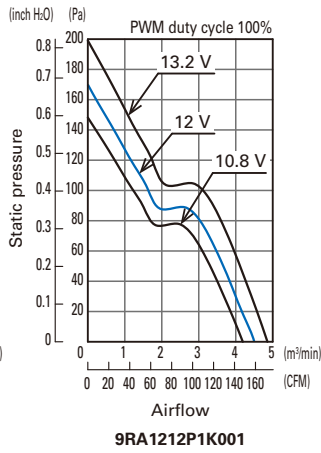

PWM duty cycle

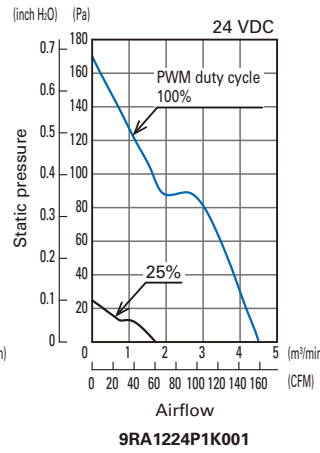

Operating voltage range

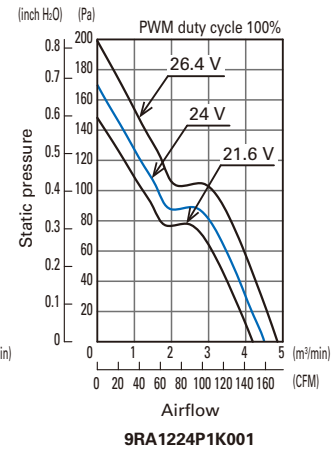

PWM duty cycle

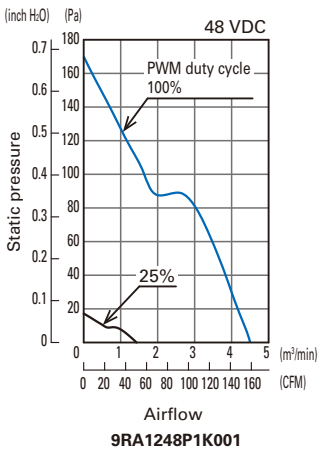

Operating voltage range

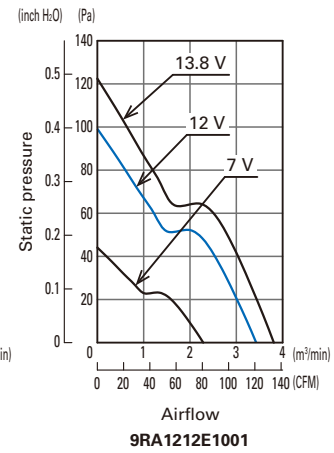
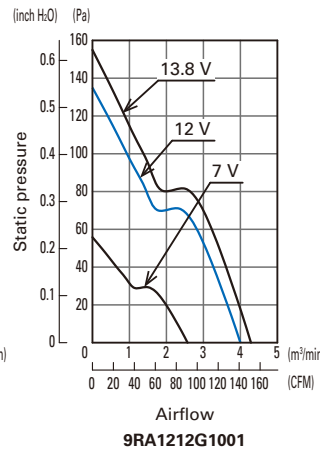
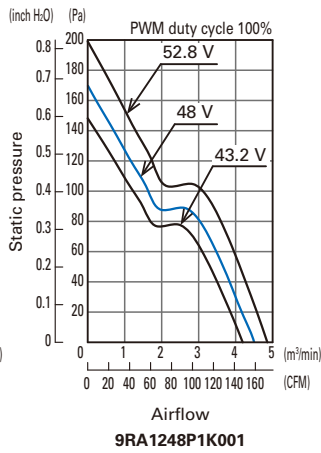

Operating voltage range

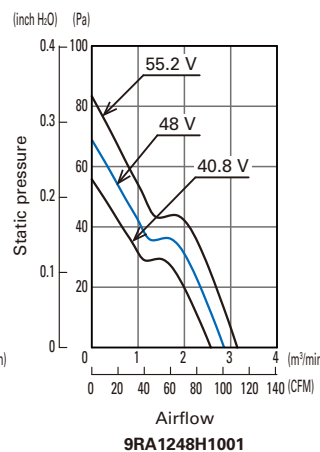
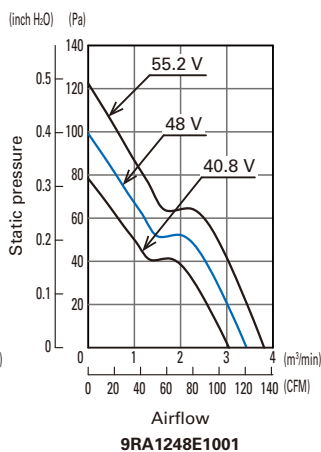
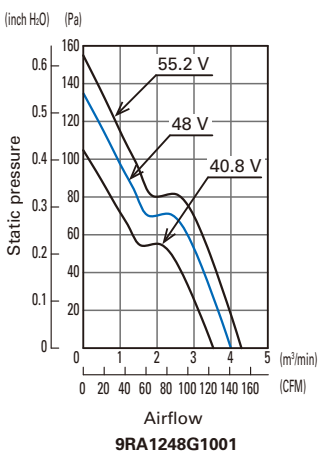
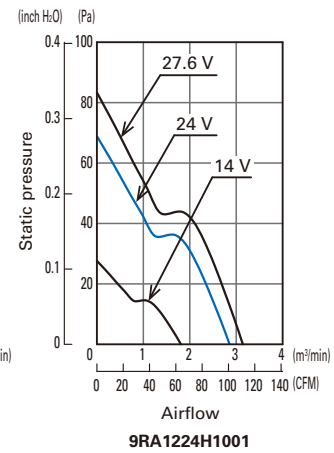
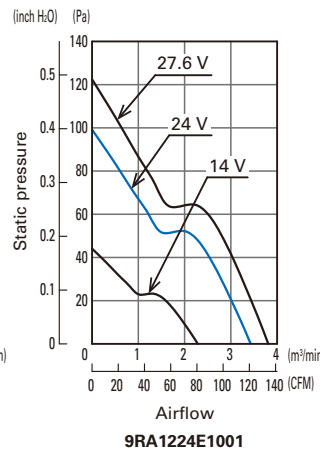
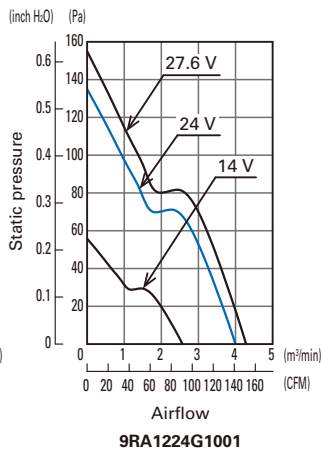
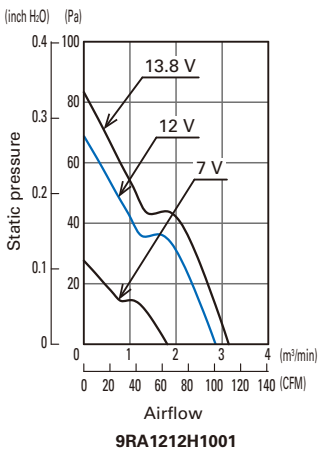

## PWM Duty - Speed Characteristics Example

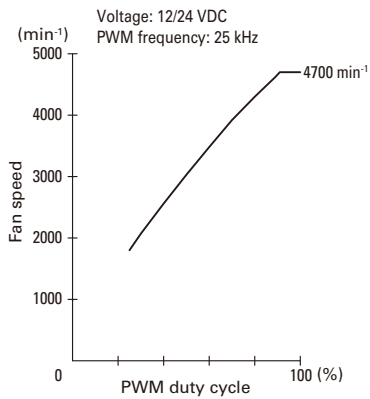

9RA1212P1K001  
9RA1224P1K001

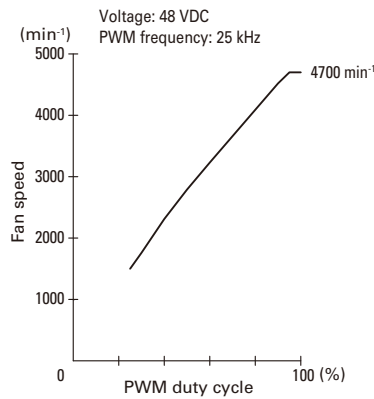

9RA1248P1K001

## PWM Input Signal Example

Input signal waveform

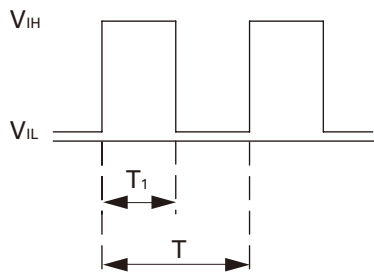

$V_{IH} = 4.75 \text{ to } 5.25 \text{ V}$     $V_{IL} = 0 \text{ to } 0.4 \text{ V}$

$\text{PWM duty cycle (\%)} = \frac{T_1}{T} \times 100$     $\text{PWM frequency } 25 \text{ (kHz)} = \frac{1}{T}$

Current source ( $I_{\text{source}}$ ) = 1.0 mA max. (when control voltage is 0 V)

Current sink ( $I_{\text{sink}}$ ) = 1.0 mA max. (when control voltage is 5.25 V)

When the PWM control terminal is open,

the fan speed is the same as the speed at 100% PWM duty cycle.

The PWM signal can be used with open collector or drain input.

Note that when using an open collector or drain input,

or inputting a different voltage or frequency,

the speed relative to the PWM duty cycle may differ from this specification.

## Example of Connection Schematic

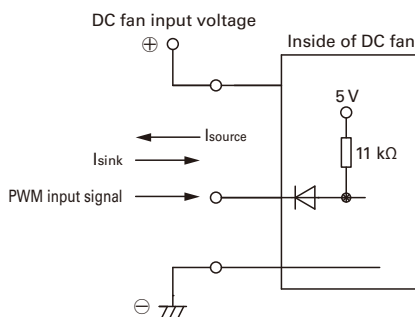

## Specifications for Pulse Sensors

Output circuit: Open collector

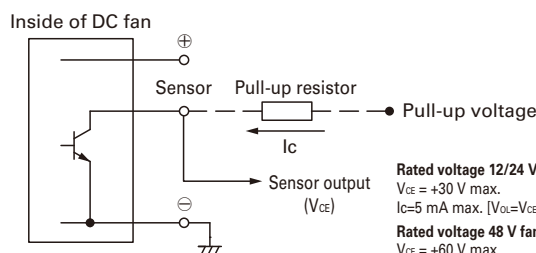

**Rated voltage 12/24 V fan** (With PWM control function)  
 $V_{CE} = +30 \text{ V max.}$   
 $I_C = 5 \text{ mA max.}$  [ $V_{OL} = V_{CE} \text{ (SAT)} = 0.6 \text{ V max.}$ ]

**Rated voltage 48 V fan** (With PWM control function)  
 $V_{CE} = +60 \text{ V max.}$   
 $I_C = 5 \text{ mA max.}$  [ $V_{OL} = V_{CE} \text{ (SAT)} = 0.6 \text{ V max.}$ ]

**Rated voltage 12/24 V fan** (Without PWM control function)  
 $V_{CE} = +30 \text{ V max.}$   
 $I_C = 10 \text{ mA max.}$  [ $V_{OL} = V_{CE} \text{ (SAT)} = 0.4 \text{ V max.}$ ]

**Rated voltage 48 V fan** (Without PWM control function)  
 $V_{CE} = +60 \text{ V max.}$   
 $I_C = 10 \text{ mA max.}$  [ $V_{OL} = V_{CE} \text{ (SAT)} = 0.4 \text{ V max.}$ ]

Output waveform (Need pull-up resistor)

In case of steady running

(One revolution)

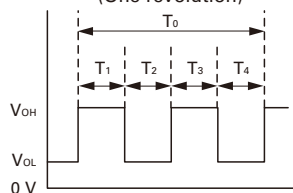

$T_{1 \text{ to } 4} \approx (1/4) T_0$

$T_{1 \text{ to } 4} \approx (1/4) T_0 = 60/4N \text{ (s)}$

$N = \text{Fan speed (min}^{-1}\text{)}$