

San Ace 140

9RA type

DC Fan

Features

Low Noise

Compared to our current model,⁽¹⁾ noise level has been reduced by 3 dB(A).

High Cooling Performance

While featuring low noise, the maximum airflow and maximum static pressure have increased by 33% and 70%,⁽²⁾ respectively, compared to the current model.⁽¹⁾

Energy Saving

Power consumption has been reduced by 35% compared to the current model.⁽¹⁾

Rich Lineup

The lineup offers four different rotational speeds for each of 12/24/48 V rated voltages.

The broad lineup of fans enables you to choose the right fan best suited to your applications.

(1) Current model: 140 x 140 x 38 mm San Ace 140 9P type DC Fan (model: 109P1448H101).

(2) For models 9RA1412P1G001, 9RA1424P1G001, and 9RA1448P1G001.



140 x 140 x 38 mm

Specifications

The models listed below **have ribs and pulse sensors with PWM control function**. For models without ribs, append "1" to the end of model numbers.

Model no.	Rated voltage [V]	Operating voltage range [V]	PWM duty cycle* [%]	Rated current [A]	Rated input [W]	Rated speed [min ⁻¹]	Max. airflow [m ³ /min] [CFM]	Max. static pressure [Pa] [inchH ₂ O]	SPL [dB(A)]	Operating temperature [°C]	Expected life [h]
9RA1412P1G001	12	10.8 to 13.2	100	1.10	13.2	4250	6.0 212	160 0.64	52	-20 to +70	40000/60°C (70000/40°C)
			20	0.09	1.1	1250	1.81 64.0	16.3 0.065	19		
9RA1424P1G001	24	21.6 to 26.4	100	0.53	12.7	4250	6.0 212	160 0.64	52		
			20	0.05	1.2	1400	2.17 76.7	21.5 0.086	22		
9RA1448P1G001	48	43.2 to 52.8	100	0.28	13.4	4250	6.0 212	160 0.64	52		
			30	0.04	1.9	1600	2.32 82.0	29.5 0.118	25		

* PWM frequency is 25 kHz. Models without ratings for 0% PWM duty cycle have zero speed at 0%. When control terminal is open, speed is the same as at 100% duty cycle.

The models listed below **have ribs and pulse sensors**. For models without ribs, append "1" to the end of model numbers.

Model no.	Rated voltage [V]	Operating voltage range [V]	Rated current [A]	Rated input [W]	Rated speed [min ⁻¹]	Max. airflow [m ³ /min] [CFM]	Max. static pressure [Pa] [inchH ₂ O]	SPL [dB(A)]	Operating temperature [°C]	Expected life [h]
9RA1412S1001	12	7 to 13.8	0.75	9.0	3750	5.3 187	130 0.52	49	-20 to +70	40000/60°C (70000/40°C)
9RA1412H1001			0.43	5.2	3050	4.3 152	92 0.37	43		
9RA1412M1001			0.19	2.3	2250	3.2 113	54 0.22	35		
9RA1424S1001	24	14 to 27.6	0.37	8.9	3750	5.3 187	130 0.52	49		
9RA1424H1001			0.22	5.3	3050	4.3 152	92 0.37	43		
9RA1424M1001			0.10	2.4	2250	3.2 113	54 0.22	35		
9RA1448S1001	48	40.8 to 55.2	0.21	10.1	3750	5.3 187	130 0.52	49		
9RA1448H1001			0.13	6.2	3050	4.3 152	92 0.37	43		
9RA1448M1001			0.06	2.9	2250	3.2 113	54 0.22	35		

Models with the following sensor specifications are also available as options: **Lock sensor**

Common Specifications

- Material Frame: Plastic (Flammability: UL 94V-0), Impeller: Plastic (Flammability: UL 94V-0)
- Expected life Refer to specifications
(L10 life: 90% survival rate for continuous operation in free air at 60°C, rated voltage)
Expected life at 40°C is for reference only.
- Motor protection function Locked rotor burnout protection, Reverse polarity protection
- Dielectric strength 50/60 Hz, 500 VAC, for 1 minute (between lead wire conductors and frame)
- Insulation resistance 10 MΩ min. at 500 VDC (between lead wire conductors and frame)
- Sound pressure level (SPL) A-weighted sound pressure level (SPL) at 1 m away from the air inlet.
- Operating temperature Refer to specifications (Non-condensing)
- Storage temperature -30 to +70°C (Non-condensing)
- Lead wire ⊕ Red ⊖ Black (Sensor) Yellow (Control) Brown
(For models without PWM control function, there is no speed control wiring.)
- Mass 360 g

Airflow - Static Pressure Characteristics

PWM duty cycle

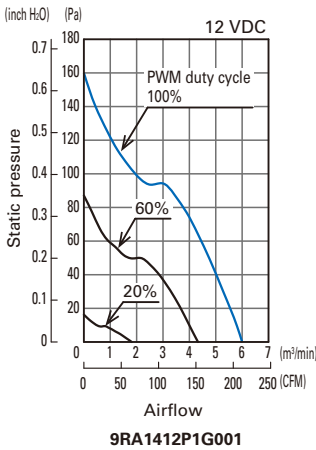

Operating voltage range

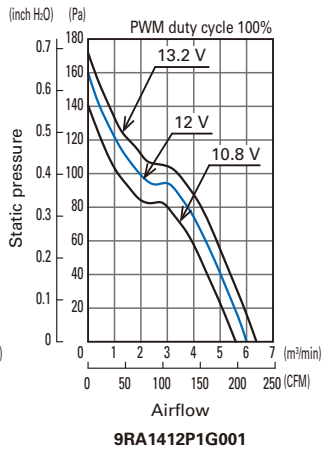

PWM duty cycle

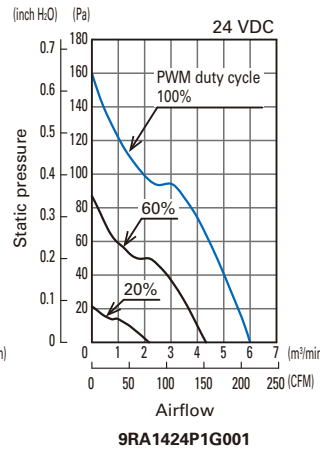

Operating voltage range

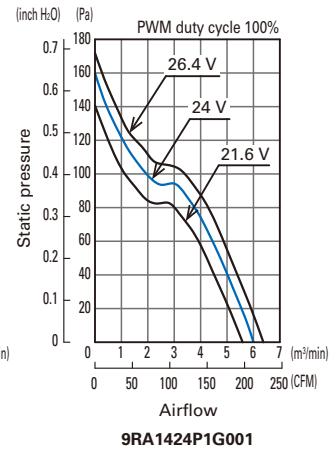

PWM duty cycle

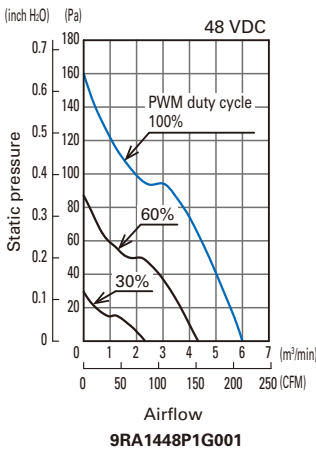

Operating voltage range

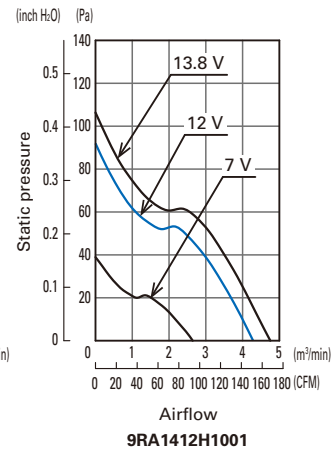
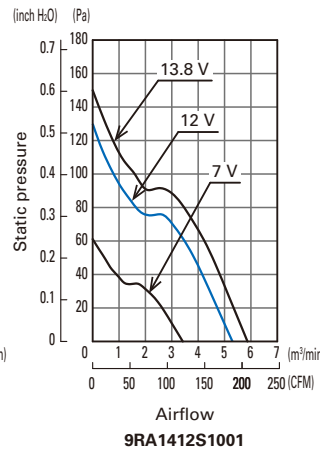
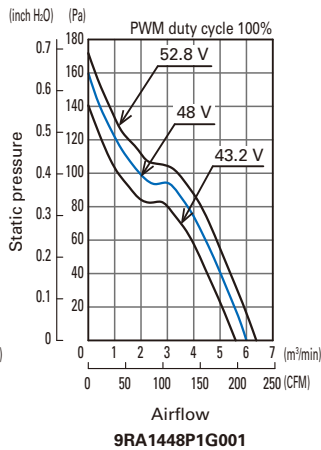

Operating voltage range

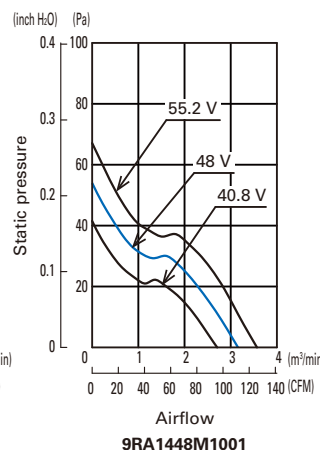
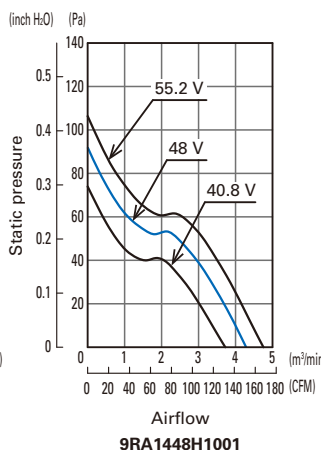
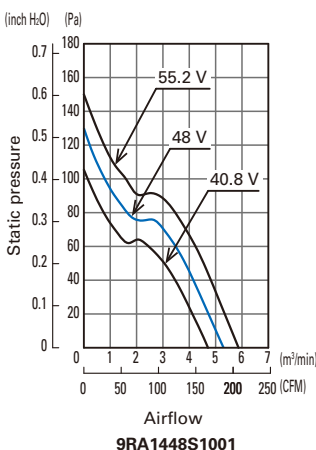
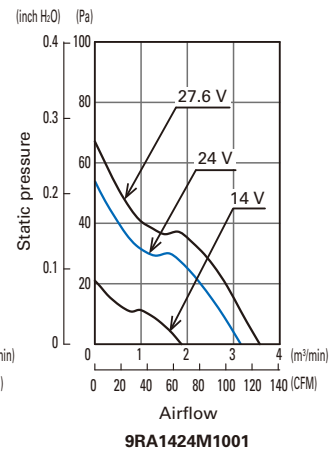
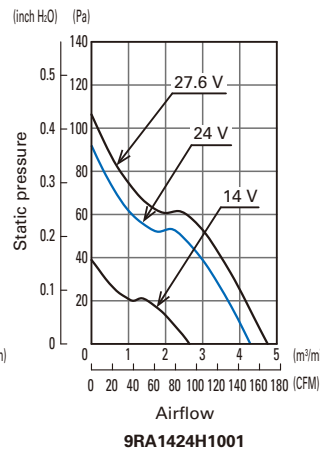
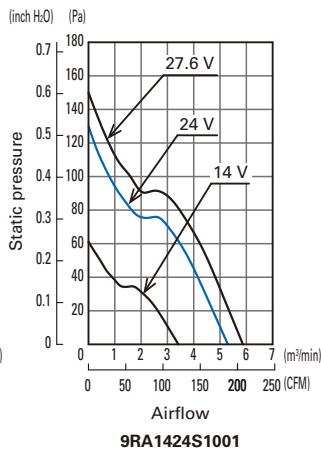
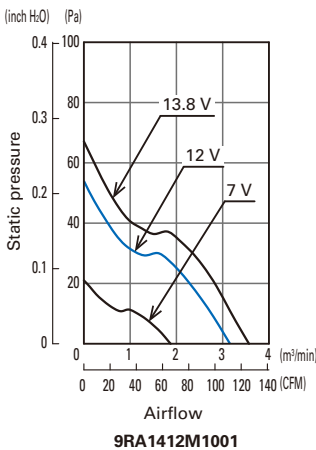

PWM Duty - Speed Characteristics Example

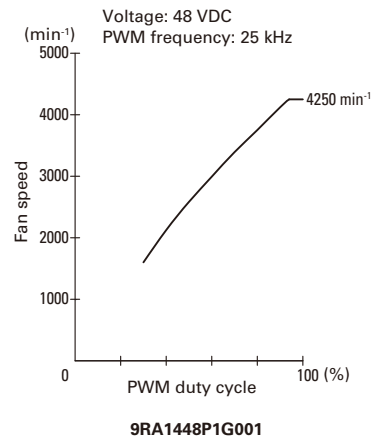
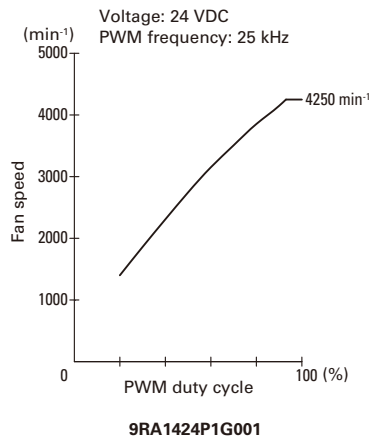
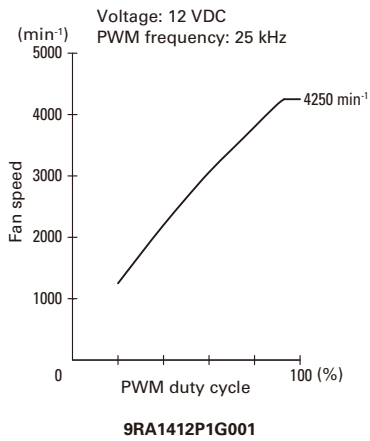

PWM Input Signal Example

Input signal waveform

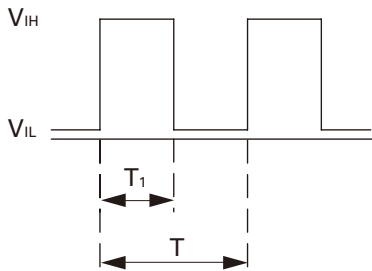

$$V_{IH} = 4.75 \text{ to } 5.25 \text{ V} \quad V_{IL} = 0 \text{ to } 0.4 \text{ V}$$

$$\text{PWM duty cycle (\%)} = \frac{T_1}{T} \times 100 \quad \text{PWM frequency } 25 \text{ (kHz)} = \frac{1}{T}$$

Current source (I_{source}) = 1.0 mA max. (when control voltage is 0 V)

Current sink (I_{sink}) = 1.0 mA max. (when control voltage is 5.25 V)

When the PWM control terminal is open,

the fan speed is the same as the speed at 100% PWM duty cycle.

The PWM signal can be used with open collector or drain input.

Note that when using an open collector or drain input,

or inputting a different voltage or frequency,

the speed relative to the PWM duty cycle may differ from this specification.

Example of Connection Schematic

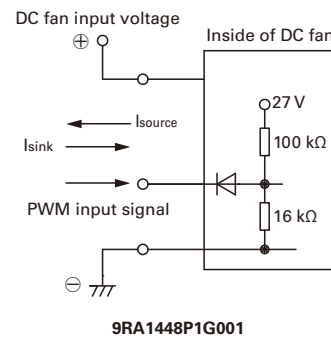
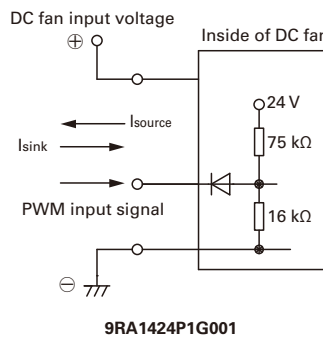
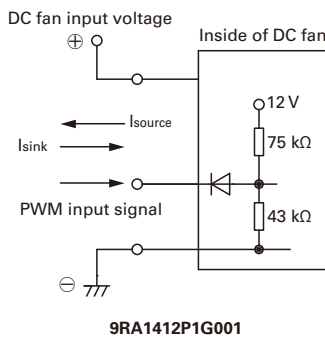

Specifications for Pulse Sensors

Output circuit: Open collector

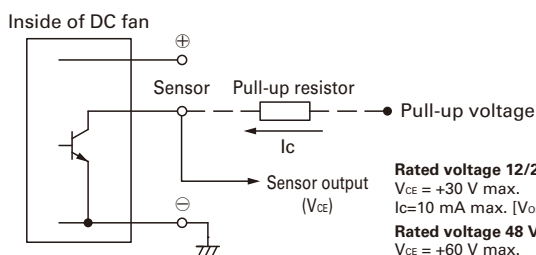

Rated voltage 12/24 V fan
 $V_{CE} = +30 \text{ V max.}$
 $I_c = 10 \text{ mA max.}$ [$V_{OL} = V_{CE} \text{ (SAT)} = 0.6 \text{ V max.}$]

Rated voltage 48 V fan
 $V_{CE} = +60 \text{ V max.}$
 $I_c = 10 \text{ mA max.}$ [$V_{OL} = V_{CE} \text{ (SAT)} = 0.6 \text{ V max.}$]

Output waveform (Need pull-up resistor)

In case of steady running

(One revolution)

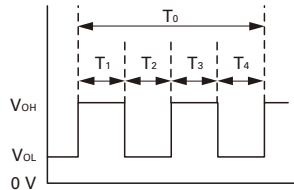

$$T_{1 \text{ to } 4} \approx (1/4) T_0$$

$$T_{1 \text{ to } 4} \approx (1/4) T_0 = 60/4N \text{ (s)}$$

$$N = \text{Fan speed (min}^{-1}\text{)}$$