

1. Features

- Designed for 2.4-2.5 GHz and 4.9-5.9GHz applications: Wi-Fi® (802.11a/b/g/n),
- Easy to integrate
- Low profile design
- High efficiency
- Intended for SMD mounting
- Supplied in tape and reel

2. Description

The Mixtus antenna is intended for use with all dual-band Wi-Fi applications, including 802.11n MIMO. The antenna requires a ground plane, i.e. your device acts as an active part of the antenna and thus demands careful consideration concerning its placement.

3. Applications

- Wearables
- Notebooks
- PC-cards
- Sensors



4. Part Number

Mixtus: A10194H

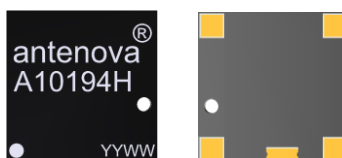

5. General Data

Product name	Mixtus
Part Number	A10194H
Frequency	2.4 – 2.5GHz and 4.9 – 5.9GHz
Polarization	Linear
Operating temperature	-40°C to 140°C
Environmental condition test	ISO16750-4, 5.1.1.1/5.1.2.1/5.3.2
Impedance with matching	50 Ω
Weight	0.2 g
Antenna type	SMD
Dimensions	10.0 x 10.0 x 0.9 (mm)

6. RF Characteristics

	2.4 – 2.5 GHz
Peak gain	1.8dBi
Average gain (Linear)	-0.5dBi
Average efficiency	>75%
Maximum return loss	-15dB
Maximum VSWR	1.4:1

	4.9 – 5.9 GHz
Peak gain	4.1dBi
Average gain (Linear)	-2.3dBi
Average efficiency	>60%
Maximum return loss	-11dB
Maximum VSWR	1.8:1

All data measured on Antenna's evaluation PCB
Part No. A10194H EVB

7. RF Performance

7.1 Return Loss

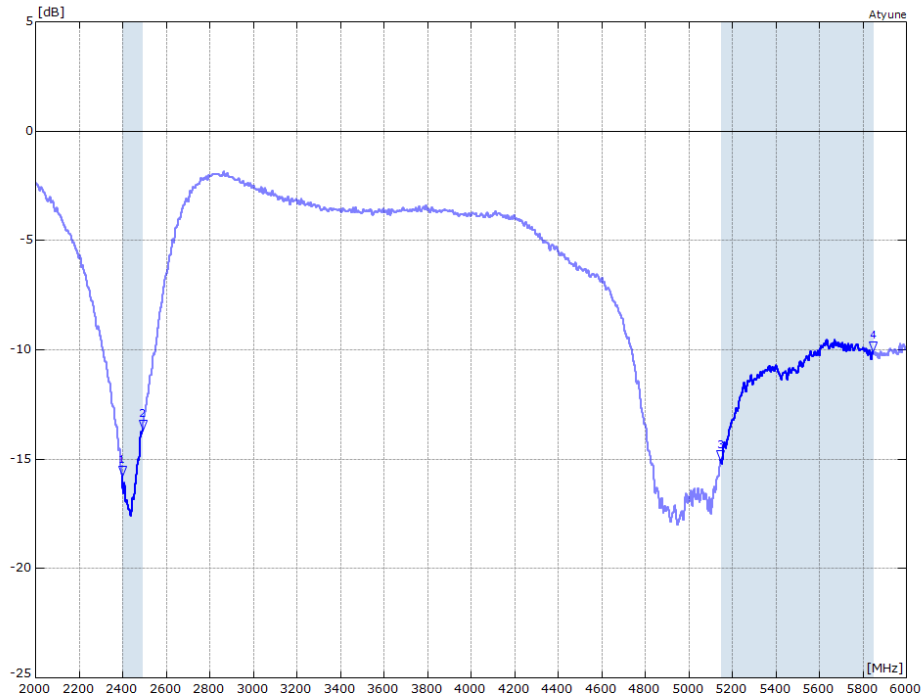

7.2 VSWR

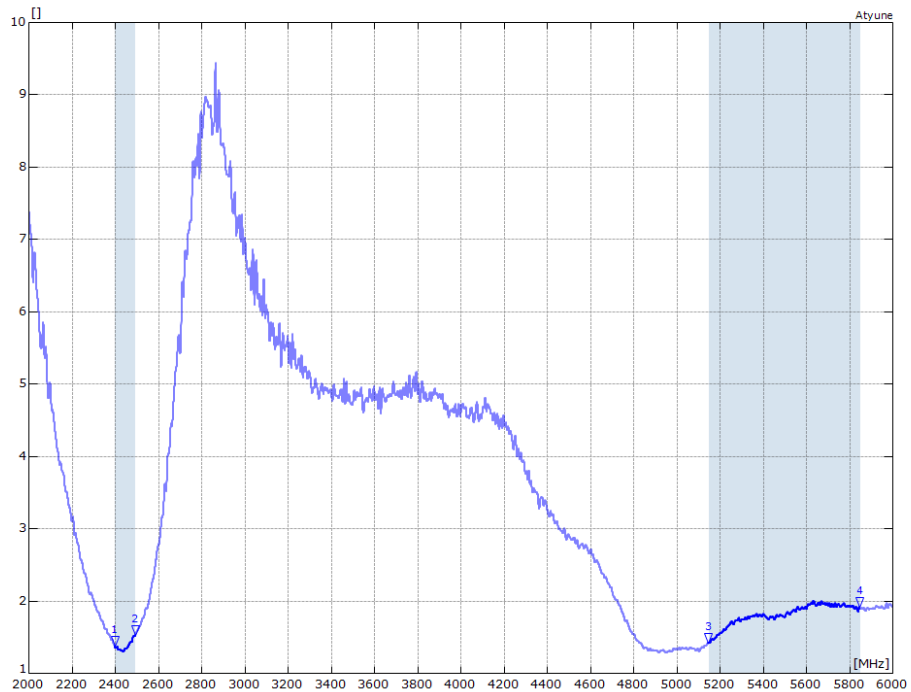

7.3 Antenna pattern

7.3.1 2400 MHz – 2500 MHz

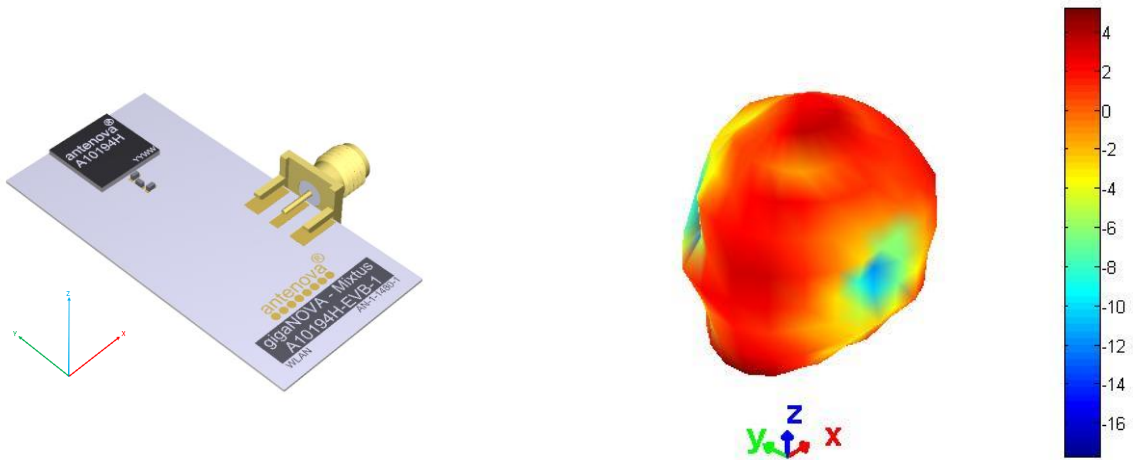

3D pattern at 2450 MHz

Drag to rotate pattern and PCB by using Adobe Reader
(Click to Activate)

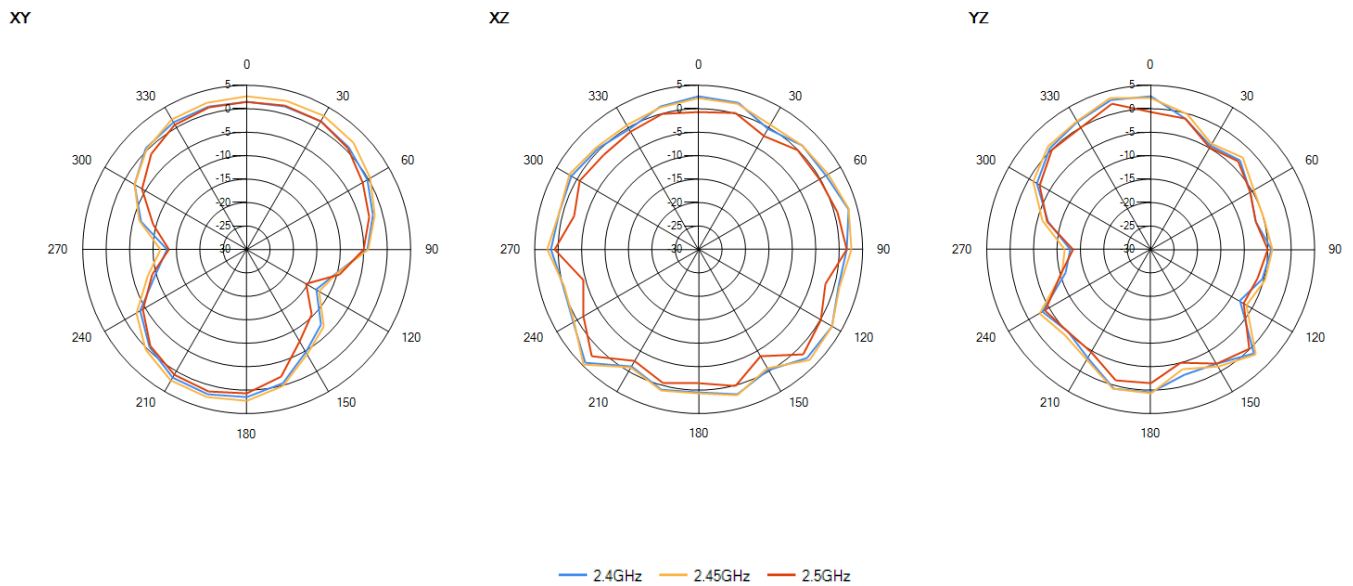

7.3.2 4900 MHz – 5900 MHz

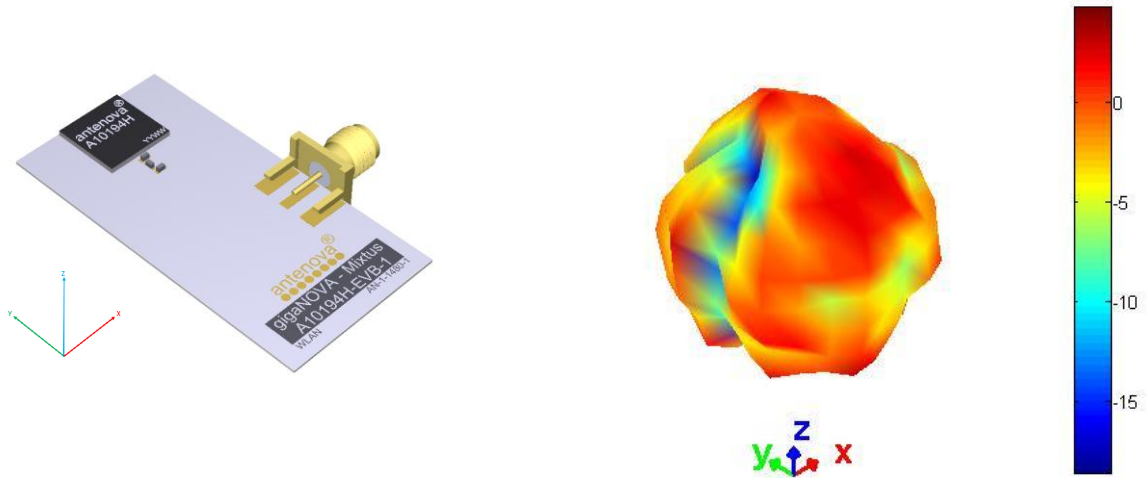

3D pattern at 5500 MHz
*Drag to rotate pattern and PCB by using Adobe Reader
(Click to Activate)*

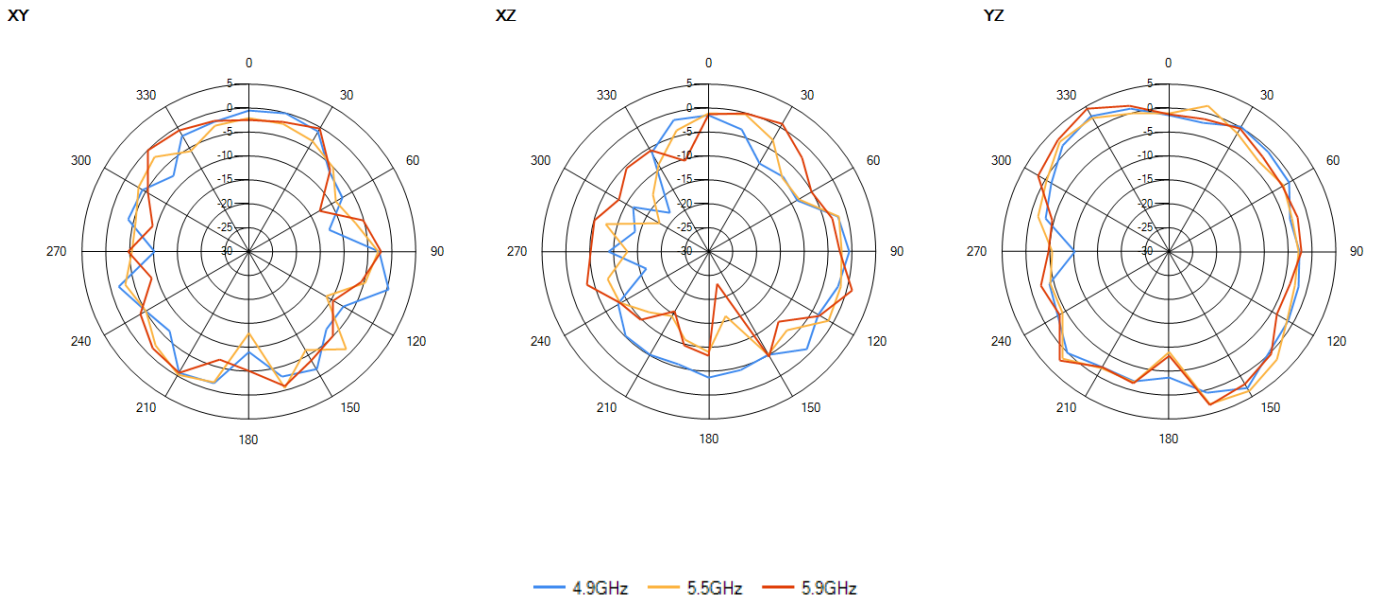

8. Antenna Dimensions

Mixtus: A10194H



All Dimensions in mm

9. Schematic symbol and Pin definition

The circuit symbol for the antenna is shown below. The antenna has five pins with only two as functional. All other pins are for mechanical strength.

Pin	Description
2	Feed
1,3,4,5	GND

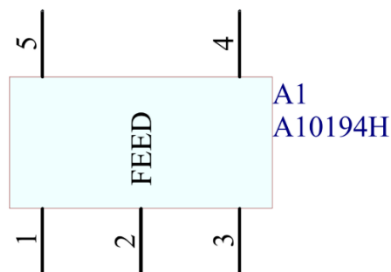

10. Antenna footprint

The recommended host PCB footprint is below.

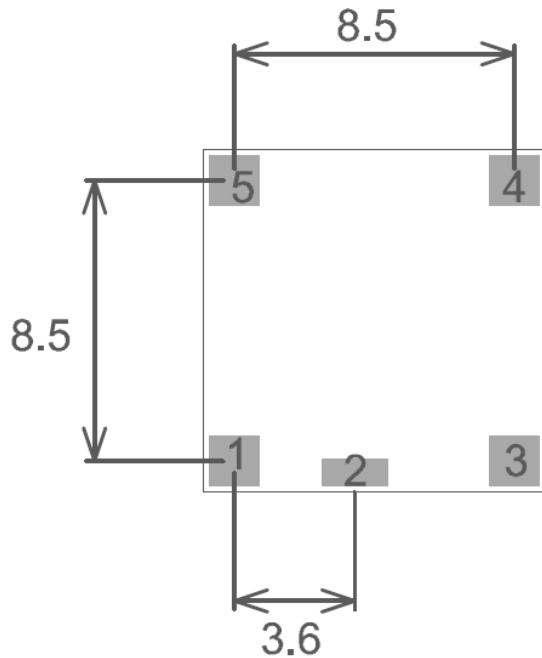

PADS 1,3,4,5 = 1.5 X 1.5 (MM)
PAD 2 = 2.0 X 0.8 (MM)
ALL DIMENSIONS IN MM

11. Electrical Interface

11.1 Transmission Line

All transmission lines should be designed to have a characteristic impedance of 50Ω.

- The length of the transmission lines should be kept to a minimum
- Any other parts of the RF system like transceivers, power amplifiers, etc, should also be designed to have an impedance of 50 Ω

Once the material for the PCB has been chosen (PCB thickness and dielectric constant), a coplanar transmission line can easily be designed using any of the commercial software packages for transmission line design. For the chosen PCB thickness, copper thickness and substrate dielectric constant, the program will calculate the appropriate transmission line width and gaps on either side of the track, so the characteristic impedance of the co-planar transmission is 50 Ω.

11.2 Matching Circuit

The antenna requires a matching circuit that must be optimized for each product. The matching circuit will require up to three components and the following circuit should be designed into the host PCB. Not all components may be required but should be included as a precaution. The matching network must be placed close to the antenna feed to ensure it is more effective in tuning the antenna.

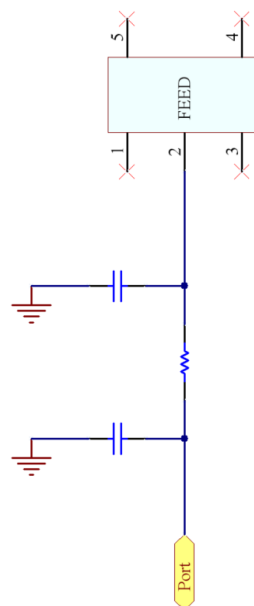

12. Antenna Integration Guide

12.1 Antenna Placement

Antenova strongly recommends placing the antenna near the edge of the board. Maximum antenna performance is achieved by placing the antenna towards one of the corners of the PCB and with the feed point of the antenna as close to the same corner of the PCB as possible.

Additional ground and components near the antenna should be at a distance of at least 5 mm from the left hand side and 18 mm or more from the right hand side as shown in the drawing above.

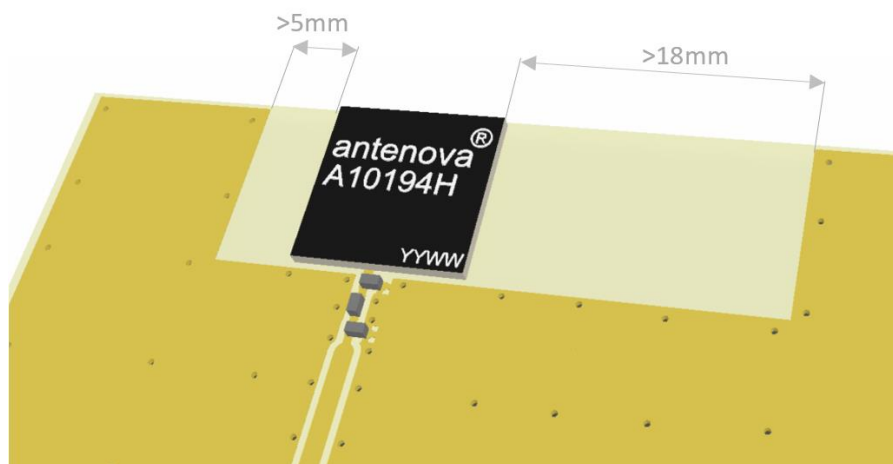

13. Reference Board

The reference board has been designed for the purpose of evaluating A10194H and includes a SMA female connector.

A10194H Evaluation Board

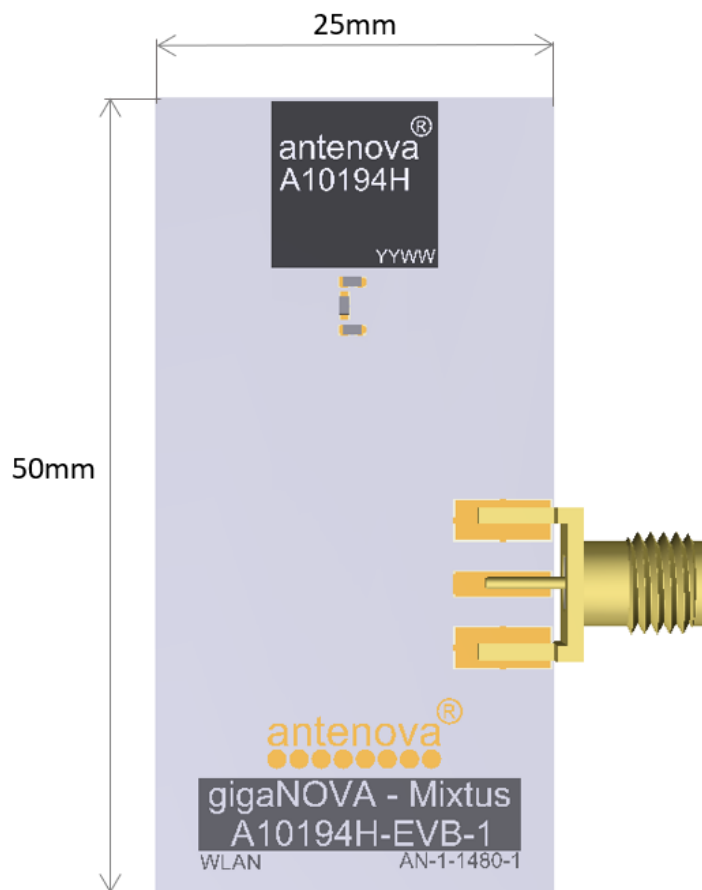

To order a reference board please see www.antenova.com

14. Reference Board Matching Circuit

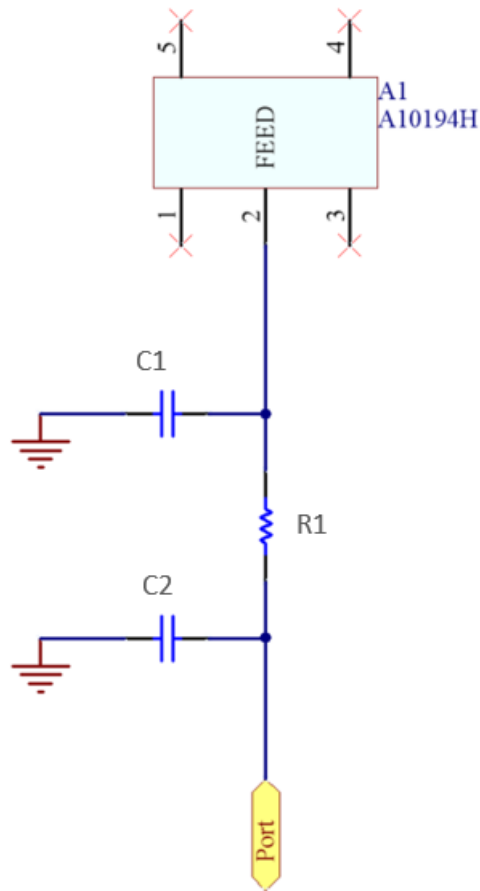

Designator	Type	Value	Description
R1	Resistor	0R	Non-specific
C1, C2	Capacitor	DNP	Not Fitted

15. Comparison S11

The A10194H is a direct replacement for the A10194 original part. The chart below shows a comparison between the two antennas on the same evaluation PCB.

15.1 Return Loss

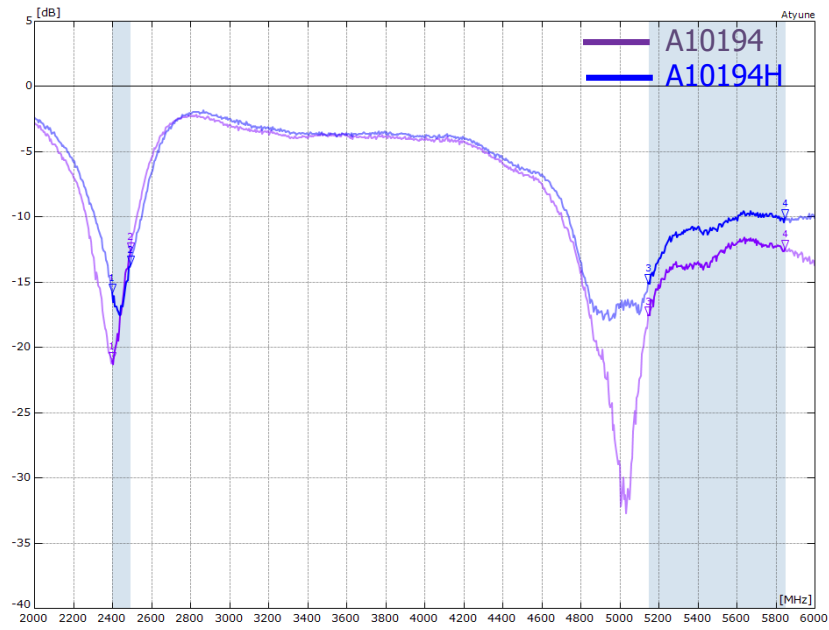

15.2 VSWR

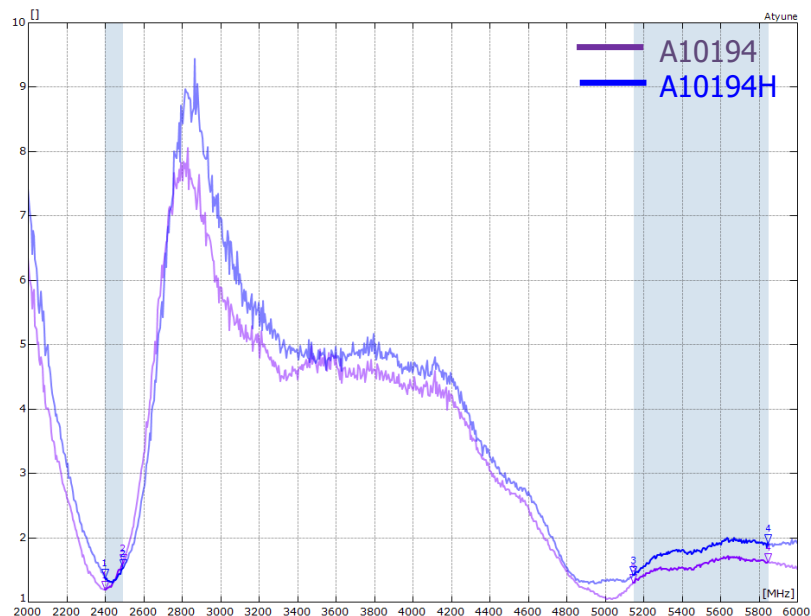

16. Soldering

This antenna is suitable for lead free soldering.

The reflow profile should be adjusted to suit the device, oven, and solder paste, while observing the following conditions:

- The maximum temperature should not exceed 240 °C
- However, for lead free soldering, a maximum temperature of 255 °C for no more than 20 seconds is permitted.
- The antenna should not be exposed to temperatures exceeding 120 °C more than 3 times during the soldering process.

17. Hazardous Material Regulation Conformance

The antenna has been tested to conform to RoHS requirements. A certificate of conformance is available from Antenova's website.

18. Packaging

18.1 Optimal Storage Conditions

Temperature	-10°C to 40°C
Humidity	Less than 75% RH
Shelf life	24 Months
Storage place	Away from corrosive gas and direct sunlight
Packaging	Reels should be stored in unopened sealed manufacturer's plastic packaging.

Note: Storage of open reels of antennas is not recommended due to possible oxidization of pads on antennas. If short term storage is necessary, then it is highly recommended that the bag containing the antenna reel is re-sealed and stored in like storage conditions as in above table.

18.2 Tape Characteristics

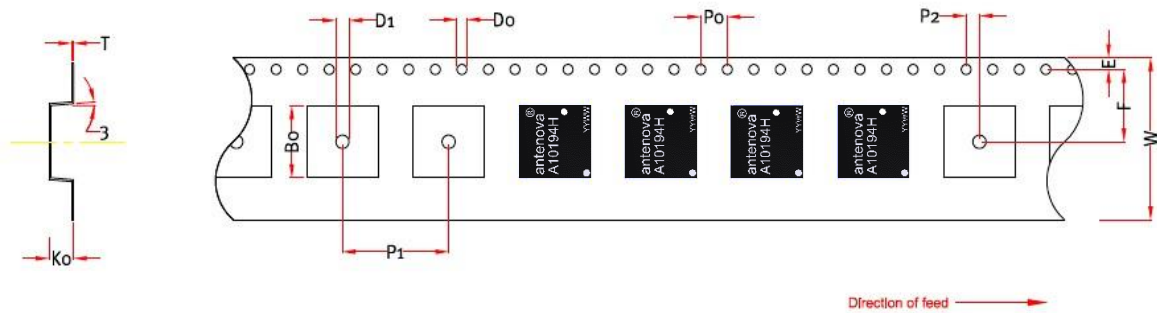

W	F	E	P0	P1	P2	B0	K0	T	D0	D1
24 ± 0.2	10.7 ± 0.1	1.75 ± 0.1	4.0 ± 0.1	16.0 ± 0.1	2.0 ± 0.1	10.7 ± 0.1	1.1 ± 0.1	0.3 ± 0.05	Min 1.55 ± 0.1	Min 2.0 ± 0.2

Dimensions in mm

Quantity	Leading Space	Trailing Space
2000 pcs / reel	50 blank antenna holders	50 blank antenna holders

18.3 Reel Dimensions

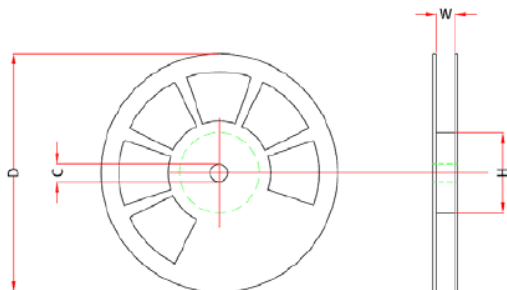

Width (W)	Reel Diameter (D)	Hub Diameter (H)	Shaft Diameter (C)
57.5 mm	330 mm ± 2.0	80 mm (2")	13.0 mm ± 0.5

18.4 Box Dimensions

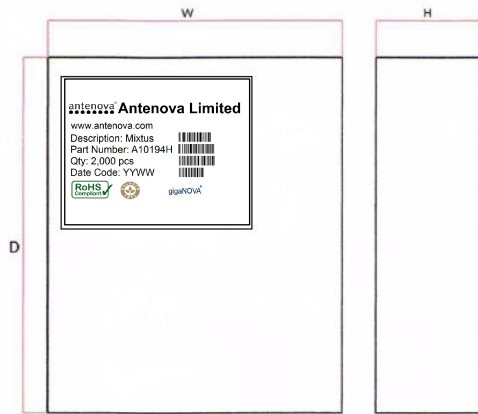

Width (W)	Breadth (B)	Thickness (H)
338 mm	335 mm	45 mm

18.5 Bag Properties

Reels are supplied in protective plastic packaging.

18.6 Reel Label Information

