

ACEPACK™ 1 sixpack topology, 650 V, 50 A, trench gate field-stop M series IGBT with soft diode and NTC

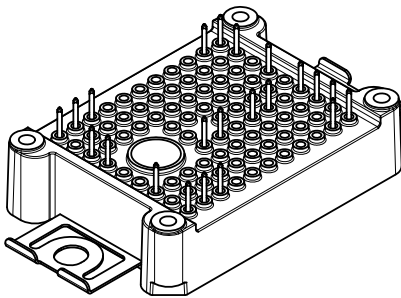

ACEPACK™ 1

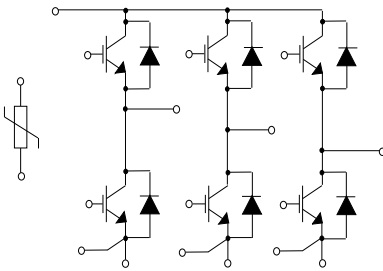

Features

- ACEPACK™ 1 power module
 - DBC Cu Al₂O₃ Cu
- Sixpack topology
 - 650 V, 50 A IGBTs and diodes
 - Soft and fast recovery diode
- Integrated NTC

Applications

- Inverters
- Industrial
- Motor drives

Description

This power module is a sixpack topology in an ACEPACK™ 1 package with NTC, integrating the advanced trench gate field-stop technologies from STMicroelectronics. This new IGBT technology represents the best compromise between conduction and switching loss, to maximize the efficiency of any converter system up to 20 kHz.



Product status

A1P50S65M2

Product summary

Order code	A1P50S65M2
Marking	A1P50S65M2
Package	ACEPACK™ 1
Leads type	Solder contact pins

1 Electrical ratings

1.1 IGBT

Limiting values at $T_J = 25\text{ °C}$, unless otherwise specified.

Table 1. Absolute maximum ratings of the IGBT

Symbol	Parameter	Value	Unit
V_{CES}	Collector-emitter voltage ($V_{GE} = 0\text{ V}$)	650	V
I_C	Continuous collector current ($T_C = 100\text{ °C}$)	50	A
$I_{CP}^{(1)}$	Pulsed collector current ($t_p = 1\text{ ms}$)	100	A
V_{GE}	Gate-emitter voltage	± 20	V
P_{TOT}	Total power dissipation of each IGBT ($T_C = 25\text{ °C}$, $T_J = 175\text{ °C}$)	208	W
T_{JMAX}	Maximum junction temperature	175	$^{\circ}\text{C}$
T_{Jop}	Operating junction temperature range under switching conditions	-40 to 150	$^{\circ}\text{C}$

1. Pulse width limited by maximum junction temperature.

Table 2. Electrical characteristics of the IGBT

Symbol	Parameter	Test conditions	Min.	Typ.	Max.	Unit
$V_{(BR)CES}$	Collector-emitter breakdown voltage	$I_C = 1\text{ mA}$, $V_{GE} = 0\text{ V}$	650			V
$V_{CE(sat)}$ (terminal)	Collector-emitter saturation voltage	$V_{GE} = 15\text{ V}$, $I_C = 50\text{ A}$ $V_{GE} = 15\text{ V}$, $I_C = 50\text{ A}$, $T_J = 150\text{ °C}$		1.95 2.3	2.3	V
$V_{GE(th)}$	Gate threshold voltage	$V_{CE} = V_{GE}$, $I_C = 1\text{ mA}$	5	6	7	V
I_{CES}	Collector cut-off current	$V_{GE} = 0\text{ V}$, $V_{CE} = 650\text{ V}$			100	μA
I_{GES}	Gate-emitter leakage current	$V_{CE} = 0\text{ V}$, $V_{GE} = \pm 20\text{ V}$			± 500	nA
C_{ies}	Input capacitance	$V_{CE} = 25\text{ V}$, $f = 1\text{ MHz}$, $V_{GE} = 0\text{ V}$		4150		pF
C_{oes}	Output capacitance			170		pF
C_{res}	Reverse transfer capacitance				80	
Q_g	Total gate charge	$V_{CC} = 520\text{ V}$, $I_C = 50\text{ A}$, $V_{GE} = \pm 15\text{ V}$		150		nC
$t_{d(on)}$	Turn-on delay time	$V_{CC} = 300\text{ V}$, $I_C = 50\text{ A}$, $R_G = 6.8\ \Omega$, $V_{GE} = \pm 15\text{ V}$,		143		ns
t_r	Current rise time				16.5	
$E_{on}^{(1)}$	Turn-on switching energy	$di/dt = 2400\text{ A}/\mu\text{s}$		0.140		mJ
$t_{d(off)}$	Turn-off delay time	$V_{CC} = 300\text{ V}$, $I_C = 50\text{ A}$, $R_G = 6.8\ \Omega$, $V_{GE} = \pm 15\text{ V}$,		112		ns
t_f	Current fall time				149	
$E_{off}^{(2)}$	Turn-off switching energy	$dv/dt = 7600\text{ V}/\mu\text{s}$		1.45		mJ

Symbol	Parameter	Test conditions	Min.	Typ.	Max.	Unit
$t_{d(on)}$	Turn-on delay time	$V_{CC} = 300\text{ V}$, $I_C = 50\text{ A}$,		148		ns
t_r	Current rise time	$R_G = 6.8\ \Omega$, $V_{GE} = \pm 15\text{ V}$,		19.2		ns
$E_{on(1)}$	Turn-on switching energy	$di/dt = 2062\text{ A}/\mu\text{s}$, $T_J = 150\text{ }^\circ\text{C}$		0.311		mJ
$t_{d(off)}$	Turn-off delay time	$V_{CC} = 300\text{ V}$, $I_C = 50\text{ A}$,		110		ns
t_f	Current fall time	$R_G = 6.8\ \Omega$, $V_{GE} = \pm 15\text{ V}$,		221		ns
$E_{off(2)}$	Turn-off switching energy	$dv/dt = 5800\text{ V}/\mu\text{s}$, $T_J = 150\text{ }^\circ\text{C}$		1.98		mJ
t_{SC}	Short-circuit withstand time	$V_{CC} \leq 360\text{ V}$, $V_{GE} \leq 15\text{ V}$, $T_{Jstart} \leq 150\text{ }^\circ\text{C}$	6			μs
R_{THJ-c}	Thermal resistance junction-to-case	Each IGBT		0.65	0.72	$^\circ\text{C}/\text{W}$
R_{THC-h}	Thermal resistance case-to-heatsink	Each IGBT, $\lambda_{grease} = 1\text{ W}/(\text{m}\cdot^\circ\text{C})$		0.79		$^\circ\text{C}/\text{W}$

1. Including the reverse recovery of the diode.
2. Including the tail of the collector current.

1.2 Diode

Limiting values at $T_J = 25\text{ }^\circ\text{C}$, unless otherwise specified.

Table 3. Absolute maximum ratings of the diode

Symbol	Parameter	Value	Unit
V_{RRM}	Repetitive peak reverse voltage	650	V
I_F	Continuous forward current at ($T_C = 100\text{ }^\circ\text{C}$)	50	A
$I_{FP(1)}$	Pulsed forward current ($t_p = 1\text{ ms}$)	100	A
T_{JMAX}	Maximum junction temperature	175	$^\circ\text{C}$
T_{Jop}	Operating junction temperature range under switching conditions	-40 to 150	$^\circ\text{C}$

1. Pulse width limited by maximum junction temperature.

Table 4. Electrical characteristics of the diode

Symbol	Parameter	Test conditions	Min.	Typ.	Max.	Unit
V_F (terminal)	Forward voltage	$I_F = 50\text{ A}$	-	1.85	2.65	V
		$I_F = 50\text{ A}$, $T_J = 150\text{ }^\circ\text{C}$	-	1.65		
t_{rr}	Reverse recovery time		-	142		ns
Q_{rr}	Reverse recovery charge	$I_F = 50\text{ A}$, $V_R = 300\text{ V}$,	-	1.87		μC
I_{rrm}	Reverse recovery current	$V_{GE} = \pm 15\text{ V}$, $di/dt = 2400\text{ A}/\mu\text{s}$	-	40		A
E_{rec}	Reverse recovery energy		-	0.41		mJ
t_{rr}	Reverse recovery time		-	260		ns
Q_{rr}	Reverse recovery charge	$I_F = 50\text{ A}$, $V_R = 300\text{ V}$,	-	5.2		μC
I_{rrm}	Reverse recovery current	$V_{GE} = \pm 15\text{ V}$, $di/dt = 2062\text{ A}/\mu\text{s}$,	-	58		A
E_{rec}	Reverse recovery energy	$T_J = 150\text{ }^\circ\text{C}$	-	1.32		mJ

Symbol	Parameter	Test conditions	Min.	Typ.	Max.	Unit
R_{THj-c}	Thermal resistance junction-to-case	Each diode	-	1.0	1.1	°C/W
R_{THc-h}	Thermal resistance case-to-heatsink	Each diode, $\lambda_{grease} = 1 \text{ W/(m}\cdot\text{°C)}$	-	0.9		°C/W

1.3 NTC

Table 5. NTC temperature sensor, considered as stand-alone

Symbol	Parameter	Test conditions	Min.	Typ.	Max.	Unit
R_{25}	Resistance	$T = 25^\circ\text{C}$		5		k Ω
R_{100}	Resistance	$T = 100^\circ\text{C}$		493		Ω
$\Delta R/R$	Deviation of R_{100}		-5		+5	%
$B_{25/50}$	B-constant			3375		K
$B_{25/80}$	B-constant			3411		K
T	Operating temperature range		-40		150	°C

Figure 1. NTC resistance vs temperature

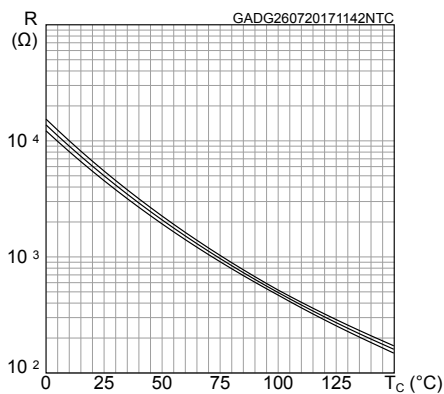
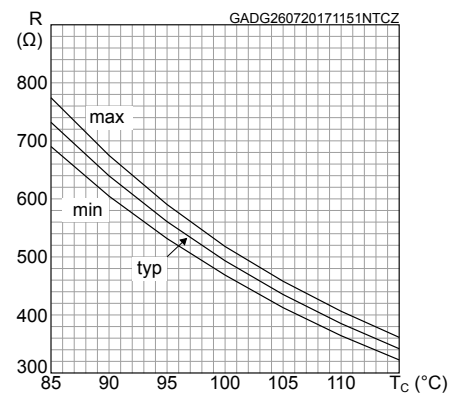

Figure 2. NTC resistance vs temperature, zoom



1.4 Package

Table 6. ACEPACK™ 1 package

Symbol	Parameter	Min.	Typ.	Max.	Unit
V_{isol}	Isolation voltage (AC voltage, $t = 60 \text{ s}$)			2500	Vrms
T_{stg}	Storage temperature	-40		125	°C
CTI	Comparative tracking index	200			
L_s	Stray inductance module P1 - EW loop		28.7		nH
R_s	Module single lead resistance, terminal-to-chip		3.9		m Ω

2 Electrical characteristics (curves)

Figure 3. IGBT output characteristics
($V_{GE} = 15\text{ V}$, terminal)

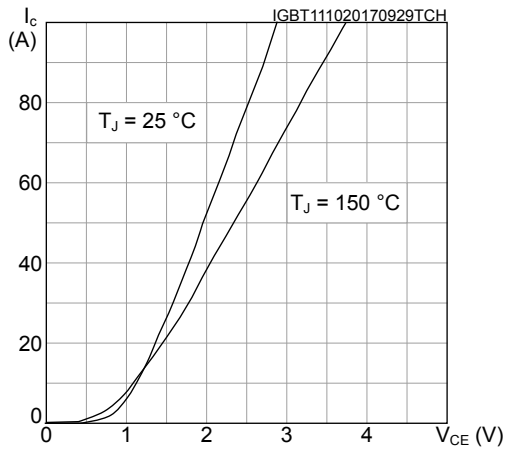

Figure 4. IGBT output characteristics
($T_J = 150\text{ °C}$, terminal)

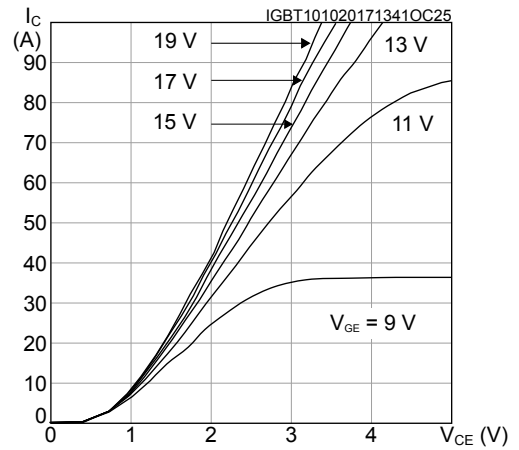

Figure 5. IGBT transfer characteristics
($V_{CE} = 15\text{ V}$, terminal)

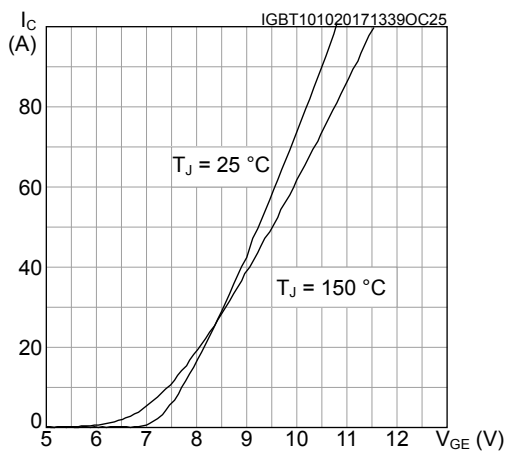

Figure 6. IGBT collector current vs case temperature

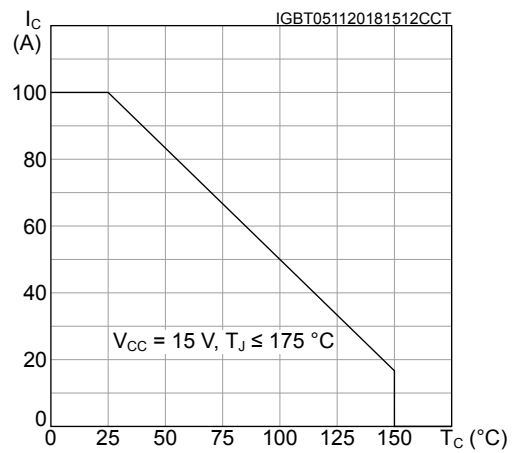

Figure 7. Switching energy vs gate resistance

Figure 8. Switching energy vs collector current

Figure 9. IGBT reverse biased safe operating area (RBSOA)

Figure 10. Diode forward characteristics

Figure 11. Diode reverse recovery energy vs diode current slope

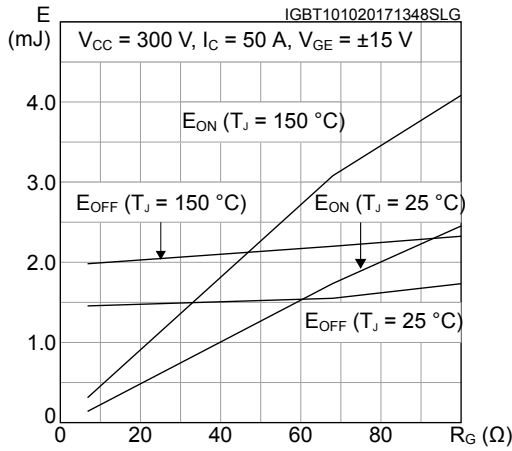
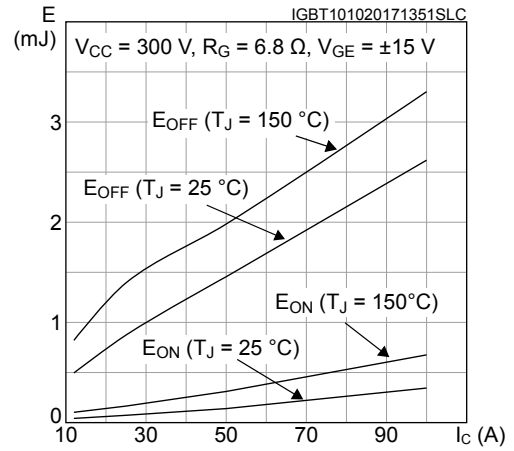
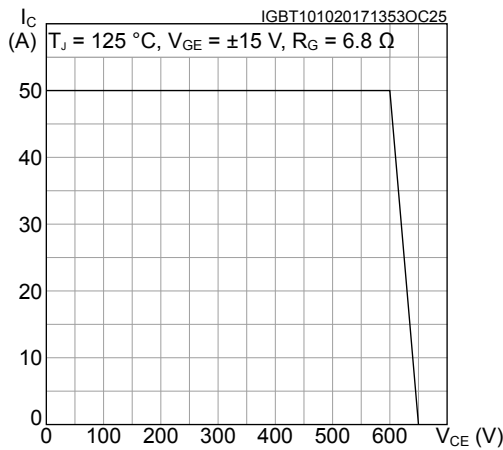
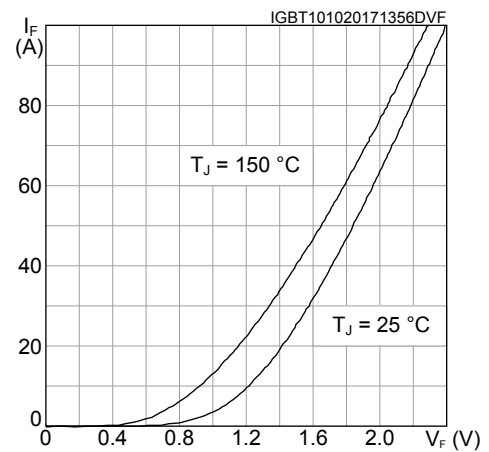
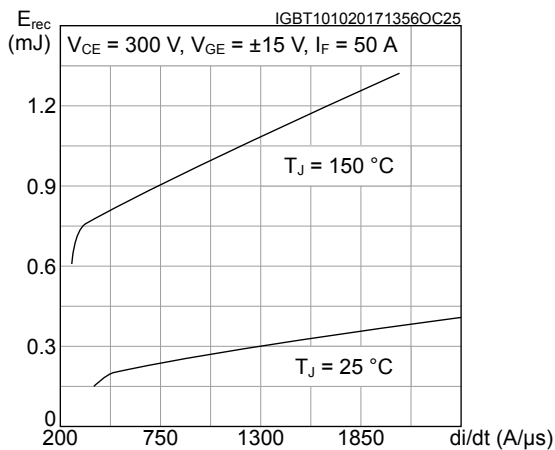
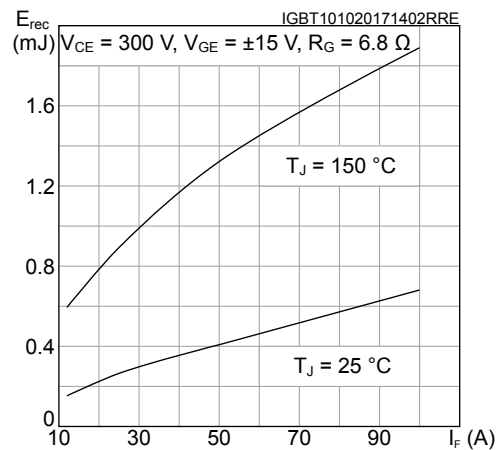
Figure 12. Diode reverse recovery energy vs forward current

Figure 13. Diode reverse recovery energy vs gate resistance

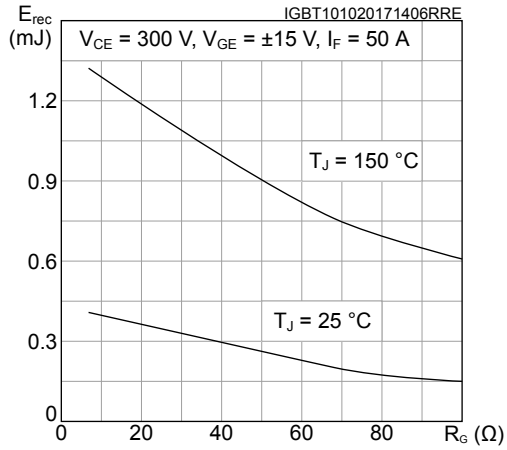

Figure 14. Inverter diode thermal impedance

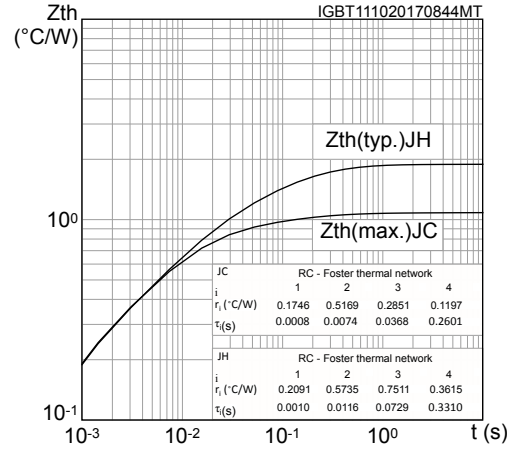
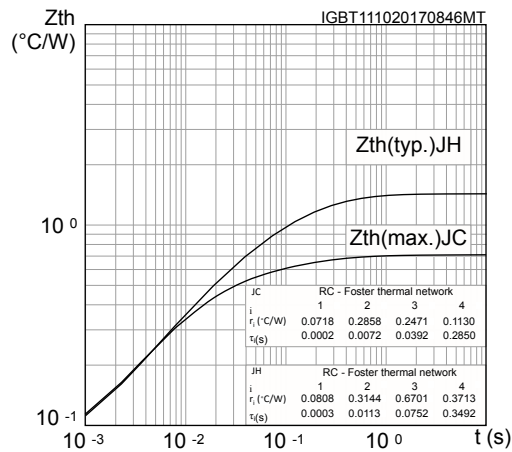
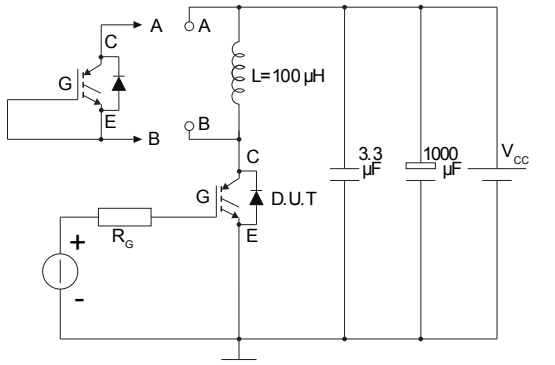

Figure 15. IGBT thermal impedance



3 Test circuits

Figure 16. Test circuit for inductive load switching

AM01504v1

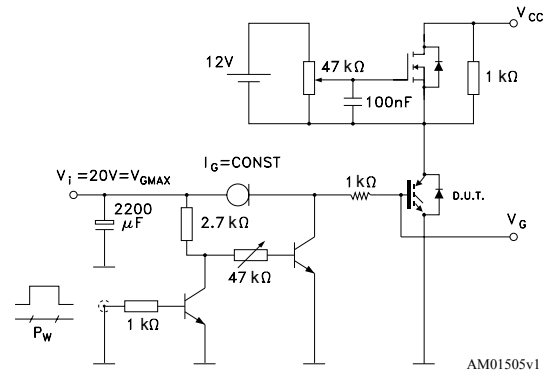
Figure 17. Gate charge test circuit

AM01505v1

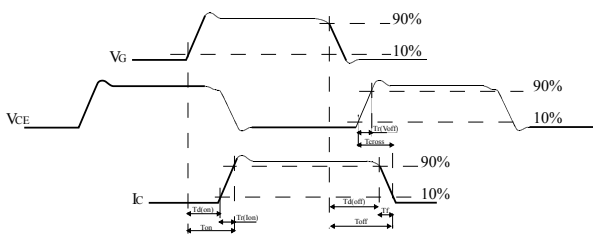
Figure 18. Switching waveform

AM01506v1

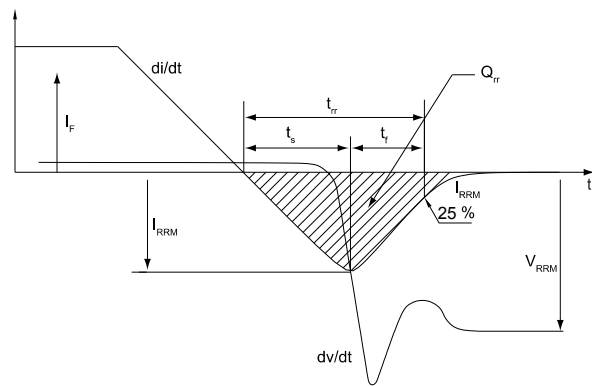
Figure 19. Diode reverse recovery waveform

AM01507v1

4 Topology and pin description

Figure 20. Electrical topology and pin description

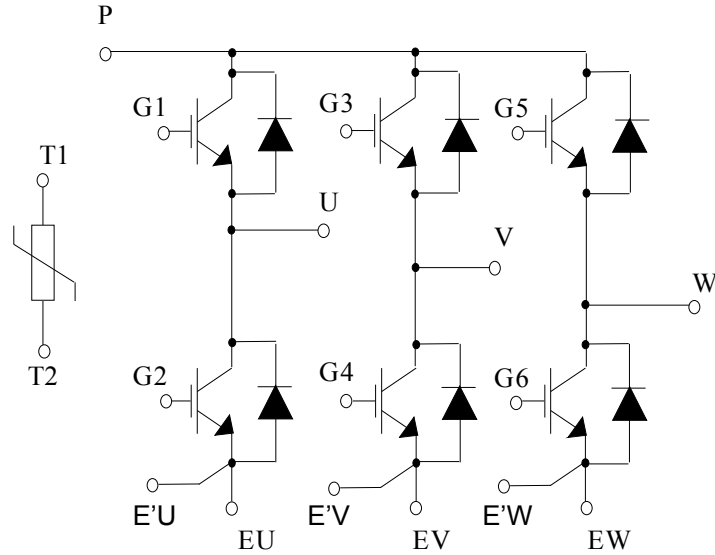
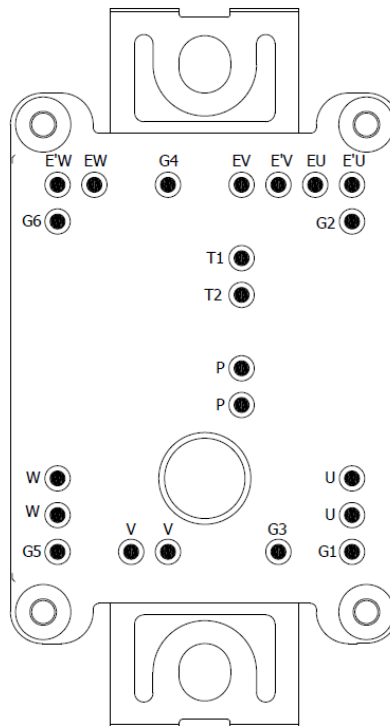

Figure 21. Package top view with sixpack pinout



5 Package information

In order to meet environmental requirements, ST offers these devices in different grades of **ECOPACK®** packages, depending on their level of environmental compliance. ECOPACK® specifications, grade definitions and product status are available at: www.st.com. ECOPACK® is an ST trademark.

5.1 ACEPACK™ 1 sixpack solder pins package information

Figure 22. ACEPACK™ 1 sixpack solder pins package outline (dimensions are in mm)

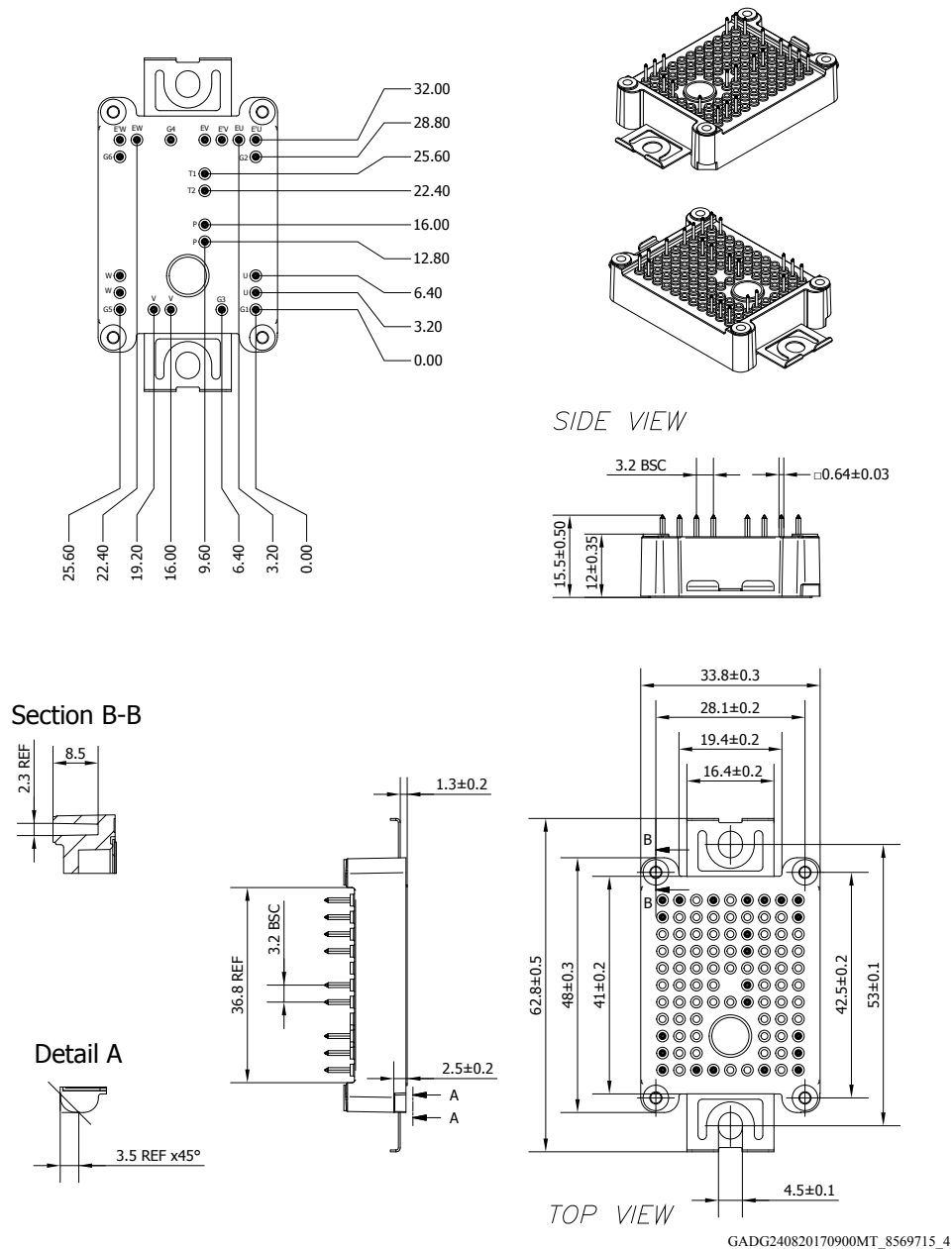

- The lead size includes the thickness of the lead plating material.
- Dimensions do not include mold protrusion.
- Package dimensions do not include any eventual metal burrs.

Revision history

Table 7. Document revision history

Date	Revision	Changes
11-Oct-2017	1	Initial release.
16-Feb-2018	2	<p>Updated features and removed maturity status indication from cover page.</p> <p>Updated <i>Figure 13. Inverter diode thermal impedance</i> and <i>Figure 14. IGBT thermal impedance</i>.</p> <p>Updated <i>Figure 21. ACEPACK™ 1 sixpack solder pins package outline (dimensions are in mm)</i>.</p> <p>Minor text changes</p>
14-Nov-2018	3	<p>Added Figure 6. IGBT collector current vs case temperature.</p> <p>Minor text changes</p>

Contents

1	Electrical ratings	2
1.1	IGBT	2
1.2	Diode	3
1.3	NTC.....	4
1.4	Package	4
2	Electrical characteristics (curves)	5
3	Test circuits	8
4	Topology and pin description	9
5	Package information	10
5.1	ACEPACK™ 1 sixpack solder pins package information	11
	Revision history	12