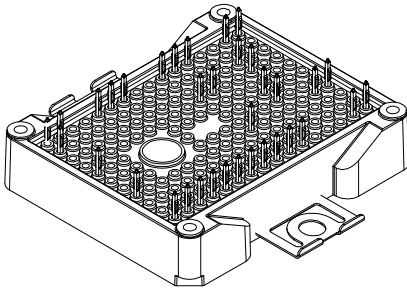
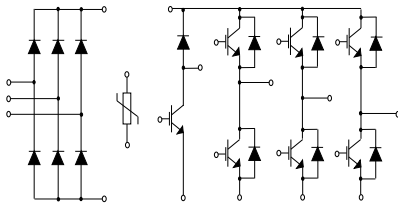

ACEPACK™ 2 converter inverter brake, 1200 V, 25 A, trench gate field-stop M series IGBT with soft diode and NTC

ACEPACK™ 2

Features

- ACEPACK™ 2 power module
 - DBC Cu Al₂O₃ Cu
- Converter inverter brake topology
 - 1600 V, very low drop rectifiers for converter
 - 1200 V, 25 A IGBTs and diodes
 - Soft and fast recovery diode
- Integrated NTC

Applications

- Inverters
- Motor drives

Description

This power module is a converter-inverter brake (CIB) topology in an ACEPACK™ 2 package with NTC, integrating the advanced trench gate field-stop technology from STMicroelectronics. This new IGBT technology represents the best compromise between conduction and switching loss, to maximize the efficiency of any converter system up to 20 kHz.



Product status

A2C25S12M3-F

Product summary

Order code	A2C25S12M3-F
Marking	A2C25S12M3-F
Package	ACEPACK™ 2
Leads type	Press fit contact pins

1 Electrical ratings

1.1 Inverter stage

Limiting values at $T_J = 25\text{ °C}$, unless otherwise specified.

1.1.1 IGBTs

Table 1. Absolute maximum ratings of the IGBTs, inverter stage

Symbol	Description	Value	Unit
V_{CES}	Collector-emitter voltage ($V_{GE} = 0\text{ V}$)	1200	V
I_C	Continuous collector current ($T_C = 100\text{ °C}$)	25	A
$I_{CP}^{(1)}$	Pulsed collector current ($t_p = 1\text{ ms}$)	50	A
V_{GE}	Gate-emitter voltage	± 20	V
P_{TOT}	Total power dissipation of each IGBT ($T_C = 25\text{ °C}$, $T_J = 175\text{ °C}$)	197	W
T_{JMAX}	Maximum junction temperature	175	$^{\circ}\text{C}$
T_{Jop}	Operating junction temperature range under switching conditions	-40 to 150	$^{\circ}\text{C}$

1. Pulse width limited by maximum junction temperature.

Table 2. Electrical characteristics of the IGBTs, inverter stage

Symbol	Parameter	Test conditions	Min.	Typ.	Max.	Unit
$V_{(BR)CES}$	Collector-emitter breakdown voltage	$I_C = 1\text{ mA}$, $V_{GE} = 0\text{ V}$	1200			V
$V_{CE(sat)}$ (terminal)	Collector-emitter saturation voltage	$V_{GE} = 15\text{ V}$, $I_C = 25\text{ A}$		1.95	2.45	V
		$V_{GE} = 15\text{ V}$, $I_C = 25\text{ A}$, $T_J = 150\text{ °C}$		2.3		V
$V_{GE(th)}$	Gate threshold voltage	$V_{CE} = V_{GE}$, $I_C = 1\text{ mA}$	5	6	7	V
I_{CES}	Collector cut-off current	$V_{GE} = 0\text{ V}$, $V_{CE} = 1200\text{ V}$			100	μA
I_{GES}	Gate-emitter leakage current	$V_{CE} = 0\text{ V}$, $V_{GE} = \pm 20\text{ V}$			± 500	nA
C_{ies}	Input capacitance	$V_{CE} = 25\text{ V}$, $f = 1\text{ MHz}$, $V_{GE} = 0\text{ V}$		1550		pF
C_{oes}	Output capacitance			130		pF
C_{res}	Reverse transfer capacitance			65		pF
Q_g	Total gate charge	$V_{CC} = 960\text{ V}$, $I_C = 25\text{ A}$, $V_{GE} = \pm 15\text{ V}$		80		nC
$t_{d(on)}$	Turn-on delay time	$V_{CC} = 600\text{ V}$, $I_C = 25\text{ A}$, $R_G = 15\text{ }\Omega$, $V_{GE} = \pm 15\text{ V}$, $di/dt = 1290\text{ A}/\mu\text{s}$		109		ns
t_r	Current rise time			15.3		ns
$E_{on}^{(1)}$	Turn-on switching energy				0.97	

Symbol	Parameter	Test conditions	Min.	Typ.	Max.	Unit
$t_{d(off)}$	Turn-off delay time	$V_{CC} = 600\text{ V}$, $I_C = 25\text{ A}$,		109		ns
t_f	Current fall time	$R_G = 15\ \Omega$, $V_{GE} = \pm 15\text{ V}$,		132		ns
$E_{off}^{(2)}$	Turn-off switching energy	$dv/dt = 9600\text{ V}/\mu\text{s}$		1.36		mJ
$t_{d(on)}$	Turn-on delay time	$V_{CC} = 600\text{ V}$, $I_C = 25\text{ A}$,		109		ns
t_r	Current rise time	$R_G = 15\ \Omega$, $V_{GE} = \pm 15\text{ V}$,		16.2		ns
$E_{on}^{(1)}$	Turn-on switching energy	$di/dt = 1274\text{ A}/\mu\text{s}$, $T_J = 150\text{ }^\circ\text{C}$		1.49		mJ
$t_{d(off)}$	Turn-off delay time	$V_{CC} = 600\text{ V}$, $I_C = 25\text{ A}$,		122		ns
t_f	Current fall time	$R_G = 15\ \Omega$, $V_{GE} = \pm 15\text{ V}$,		216		ns
$E_{off}^{(2)}$	Turn-off switching energy	$dv/dt = 8200\text{ V}/\mu\text{s}$, $T_J = 150\text{ }^\circ\text{C}$		1.85		mJ
t_{SC}	Short-circuit withstand time	$V_{CC} \leq 600\text{ V}$, $V_{GE} \leq 15\text{ V}$, $T_{Jstart} \leq 150\text{ }^\circ\text{C}$	10			μs
R_{THj-c}	Thermal resistance junction-to-case	Each IGBT		0.69	0.76	$^\circ\text{C}/\text{W}$
R_{THc-h}	Thermal resistance case-to- heatsink	Each IGBT, $\lambda_{grease} = 1\text{ W}/(\text{m}\cdot^\circ\text{C})$		0.79		$^\circ\text{C}/\text{W}$

1. Including the reverse recovery of the diode.
2. Including the tail of the collector current.

1.1.2

Diode

Limiting values at $T_J = 25\text{ }^\circ\text{C}$, unless otherwise specified.

Table 3. Absolute maximum ratings of the diode, inverter stage

Symbol	Parameter	Value	Unit
V_{RRM}	Repetitive peak reverse voltage	1200	V
I_F	Continuous forward current ($T_C = 100\text{ }^\circ\text{C}$)	25	A
$I_{FP}^{(1)}$	Pulsed forward current ($t_p = 1\text{ ms}$)	50	A
T_{JMAX}	Maximum junction temperature	175	$^\circ\text{C}$
T_{Jop}	Operating junction temperature range under switching conditions	-40 to 150	$^\circ\text{C}$

1. Pulse width limited by maximum junction temperature.

Table 4. Electrical characteristics of the diode, inverter stage

Symbol	Parameter	Test conditions	Min.	Typ.	Max.	Unit
V_F (terminal)	Forward voltage	$I_F = 25\text{ A}$	-	2.95	4.1	V
		$I_F = 25\text{ A}$, $T_J = 150\text{ }^\circ\text{C}$	-	2.3		
t_{rr}	Reverse recovery time		-	190		ns
Q_{rr}	Reverse recovery charge	$I_F = 25\text{ A}$, $V_R = 600\text{ V}$,	-	1.53		μC
I_{rrm}	Reverse recovery current	$V_{GE} = \pm 15\text{ V}$, $di_F/dt = 1290\text{ A}/\mu\text{s}$	-	29		A
E_{rec}	Reverse recovery energy		-	0.74		mJ

Symbol	Parameter	Test conditions	Min.	Typ.	Max.	Unit
t_{rr}	Reverse recovery time	$I_F = 25\text{ A}$, $V_R = 600\text{ V}$, $V_{GE} = \pm 15\text{ V}$, $di_F/dt = 1274\text{ A}/\mu\text{s}$, $T_J = 150\text{ }^\circ\text{C}$	-	378		ns
Q_{rr}	Reverse recovery charge		-	4.43		μC
I_{rrm}	Reverse recovery current		-	41		A
E_{rec}	Reverse recovery energy		-	2.33		mJ
R_{THj-c}	Thermal resistance junction-to-case	Each diode	-	1.05	1.16	$^\circ\text{C}/\text{W}$
R_{THc-h}	Thermal resistance case-to-heatsink	Each diode, $\lambda_{grease} = 1\text{ W}/(\text{m}\cdot^\circ\text{C})$	-	0.85		$^\circ\text{C}/\text{W}$

1.2 Brake stage

Limiting values at $T_J = 25\text{ }^\circ\text{C}$, unless otherwise specified.

1.2.1 IGBT

Table 5. Absolute maximum ratings of the IGBT, brake stage

Symbol	Parameter	Value	Unit
V_{CES}	Collector-emitter voltage ($V_{GE} = 0\text{ V}$)	1200	V
I_C	Continuous collector current ($T_C = 100\text{ }^\circ\text{C}$)	25	A
$I_{CP}^{(1)}$	Pulsed collector current ($t_p = 1\text{ ms}$)	50	A
V_{GE}	Gate-emitter voltage	± 20	V
P_{TOT}	Total power dissipation of each IGBT ($T_C = 25\text{ }^\circ\text{C}$, $T_J = 175\text{ }^\circ\text{C}$)	197	W
T_{JMAX}	Maximum junction temperature	175	$^\circ\text{C}$
T_{Jop}	Operating junction temperature range under switching conditions	-40 to 150	$^\circ\text{C}$

1. Pulse width limited by maximum junction temperature.

Table 6. Electrical characteristics of the IGBT, brake stage

Symbol	Parameter	Test conditions	Min.	Typ.	Max.	Unit
$V_{(BR)CES}$	Collector-emitter breakdown voltage	$I_C = 1\text{ mA}$, $V_{GE} = 0\text{ V}$	1200			V
$V_{CE(sat)}$ (terminal)	Collector-emitter saturation voltage	$V_{GE} = 15\text{ V}$, $I_C = 25\text{ A}$		1.95		V
		$V_{GE} = 15\text{ V}$, $I_C = 25\text{ A}$, $T_J = 150\text{ }^\circ\text{C}$		2.3		
$V_{GE(th)}$	Gate threshold voltage	$V_{CE} = V_{GE}$, $I_C = 1\text{ mA}$	5	6	7	V
I_{CES}	Collector cut-off current	$V_{GE} = 0\text{ V}$, $V_{CE} = 1200\text{ V}$			100	μA
I_{GES}	Gate-emitter leakage current	$V_{CE} = 0\text{ V}$, $V_{GE} = \pm 20\text{ V}$			± 500	nA
C_{ies}	Input capacitance	$V_{CE} = 25\text{ V}$, $f = 1\text{ MHz}$, $V_{GE} = 0\text{ V}$		1550		pF
C_{oes}	Output capacitance				130	pF
C_{res}	Reverse transfer capacitance				65	pF
Q_g	Total gate charge	$V_{CC} = 960\text{ V}$, $I_C = 25\text{ A}$, $V_{GE} = \pm 15\text{ V}$		80		nC

Symbol	Parameter	Test conditions	Min.	Typ.	Max.	Unit
$t_{d(on)}$	Turn-on delay time	$V_{CC} = 600\text{ V}$, $I_C = 25\text{ A}$, $R_G = 15\ \Omega$, $V_{GE} = \pm 15\text{ V}$, $di/dt = 1290\text{ A}/\mu\text{s}$		109		ns
t_r	Current rise time			15.3		ns
$E_{on}^{(1)}$	Turn-on switching energy			0.97		mJ
$t_{d(off)}$	Turn-off delay time	$V_{CC} = 600\text{ V}$, $I_C = 25\text{ A}$, $R_G = 15\ \Omega$, $V_{GE} = \pm 15\text{ V}$, $dv/dt = 9600\text{ V}/\mu\text{s}$		109		ns
t_f	Current fall time			132		ns
$E_{off}^{(2)}$	Turn-off switching energy			1.36		mJ
$t_{d(on)}$	Turn-on delay time	$V_{CC} = 600\text{ V}$, $I_C = 25\text{ A}$, $R_G = 15\ \Omega$, $V_{GE} = \pm 15\text{ V}$, $di/dt = 1274\text{ A}/\mu\text{s}$, $T_J = 150\text{ }^\circ\text{C}$		109		ns
t_r	Current rise time			16.2		ns
$E_{on}^{(1)}$	Turn-on switching energy			1.49		mJ
$t_{d(off)}$	Turn-off delay time	$V_{CC} = 600\text{ V}$, $I_C = 25\text{ A}$, $R_G = 15\ \Omega$, $V_{GE} = \pm 15\text{ V}$, $dv/dt = 8200\text{ V}/\mu\text{s}$, $T_J = 150\text{ }^\circ\text{C}$		122		ns
t_f	Current fall time			216		ns
$E_{off}^{(2)}$	Turn-off switching energy			1.85		mJ
t_{SC}	Short-circuit withstand time	$V_{CC} \leq 600\text{ V}$, $V_{GE} \leq 15\text{ V}$, $T_{Jstart} \leq 150\text{ }^\circ\text{C}$	10			μs
R_{THj-c}	Thermal resistance junction-to-case	Each IGBT		0.69	0.76	$^\circ\text{C}/\text{W}$
R_{THc-h}	Thermal resistance case-to-heatsink	Each IGBT, $\lambda_{grease} = 1\text{ W}/(\text{m}\cdot^\circ\text{C})$		0.79		$^\circ\text{C}/\text{W}$

1. Including the reverse recovery of the diode.
2. Including the tail of the collector current.

1.2.2 Diode

Table 7. Absolute maximum ratings of the diode, brake stage

Symbol	Parameter	Value	Unit
V_{RRM}	Repetitive peak reverse voltage	1200	V
I_F	Continuous forward current ($T_C = 100\text{ }^\circ\text{C}$)	25	A
$I_{FP}^{(1)}$	Pulsed forward current ($t_p = 1\text{ ms}$)	50	A
T_{JMAX}	Maximum junction temperature	175	$^\circ\text{C}$
T_{Jop}	Operating junction temperature range under switching conditions	-40 to 150	$^\circ\text{C}$

1. Pulse width limited by maximum junction temperature.

Table 8. Electrical characteristics of the diode, brake stage

Symbol	Parameter	Test conditions	Min.	Typ.	Max.	Unit
V_F (terminal)	Forward voltage	$I_F = 25\text{ A}$	-	2.95		V
		$I_F = 25\text{ A}$, $T_J = 150\text{ }^\circ\text{C}$	-	2.3		
t_{rr}	Reverse recovery time	$I_F = 25\text{ A}$, $V_R = 600\text{ V}$, $V_{GE} = \pm 15\text{ V}$, $di/dt = 1290\text{ A}/\mu\text{s}$	-	190		ns
Q_{rr}	Reverse recovery charge		-	1.53		μC
I_{rrm}	Reverse recovery current		-	29		A
E_{rec}	Reverse recovery energy		-	0.74		mJ

Symbol	Parameter	Test conditions	Min.	Typ.	Max.	Unit
t_{rr}	Reverse recovery time	$I_F = 25\text{ A}$, $V_R = 600\text{ V}$, $V_{GE} = \pm 15\text{ V}$, $di/dt = 1274\text{ A}/\mu\text{s}$, $T_J = 150\text{ }^\circ\text{C}$	-	378		ns
Q_{rr}	Reverse recovery charge		-	4.43		μC
I_{rrm}	Reverse recovery current		-	41		A
E_{rec}	Reverse recovery energy		-	2.33		mJ
R_{THj-c}	Thermal resistance junction-to-case	Each diode	-	1.05	1.16	$^\circ\text{C}/\text{W}$
R_{THc-h}	Thermal resistance case-to-heatsink	Each diode, $\lambda_{grease} = 1\text{ W}/(\text{m}\cdot^\circ\text{C})$	-	0.85		$^\circ\text{C}/\text{W}$

1.3
Converter stage

 Limiting values at $T_J = 25\text{ }^\circ\text{C}$, unless otherwise specified.

Table 9. Absolute maximum ratings of the bridge rectifiers

Symbol	Description	Value	Unit
V_{RRM}	Repetitive peak reverse voltage	1600	V
I_F	RMS forward current	50	A
I_{FSM}	Forward surge current $t_p = 10\text{ ms}$, $T_C = 25\text{ }^\circ\text{C}$	450	A
	Forward surge current $t_p = 10\text{ ms}$, $T_C = 150\text{ }^\circ\text{C}$	365	
I^2t	$t_p = 10\text{ ms}$, $T_C = 25\text{ }^\circ\text{C}$	1012	A^2s
	$t_p = 10\text{ ms}$, $T_C = 150\text{ }^\circ\text{C}$	666	
T_{JMAX}	Maximum junction temperature	175	$^\circ\text{C}$
T_{Jop}	Operating junction temperature range under switching conditions	-40 to 150	$^\circ\text{C}$

Table 10. Electrical characteristics of the bridge rectifiers

Symbol	Parameter	Test conditions	Min.	Typ.	Max.	Unit
V_F (terminal)	Forward voltage	$I_F = 25\text{ A}$	-	1.05	1.4	V
		$I_F = 25\text{ A}$, $T_J = 150\text{ }^\circ\text{C}$	-	0.92		
I_R	Reverse current	$T_J = 150\text{ }^\circ\text{C}$, $V_R = 1600\text{ V}$	-	1		mA
R_{THj-c}	Thermal resistance junction-to-case	Each diode	-	1.00	1.10	$^\circ\text{C}/\text{W}$
R_{THc-h}	Thermal resistance case-to-heatsink	Each diode, $\lambda_{grease} = 1\text{ W}/(\text{m}\cdot^\circ\text{C})$	-	0.95		$^\circ\text{C}/\text{W}$

1.4 NTC

Table 11. NTC temperature sensor, considered as stand-alone

Symbol	Parameter	Test condition	Min.	Typ.	Max.	Unit
R ₂₅	Resistance	T = 25 °C		5		kΩ
R ₁₀₀	Resistance	T = 100 °C		493		Ω
ΔR/R	Deviation of R ₁₀₀		-5		+5	%
B _{25/50}	B-constant			3375		K
B _{25/80}	B-constant			3411		K
T	Operating temperature range		-40		150	°C

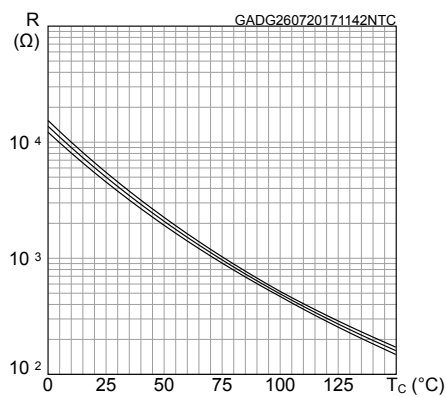
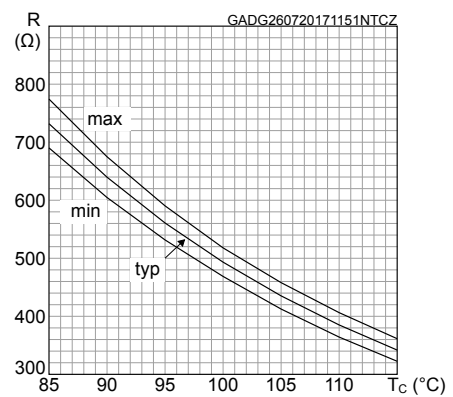
Figure 1. NTC resistance vs temperature

Figure 2. NTC resistance vs temperature, zoom

1.5 Package

Table 12. ACEPACK™ 2 package

Symbol	Parameter	Min.	Typ.	Max.	Unit
V _{isol}	Isolation voltage (AC voltage, t = 60 s)			2500	Vrms
T _{stg}	Storage temperature	-40		125	°C
CTI	Comparative tracking index	200			
L _s	Stray inductance module P1 - EW loop		33.5		nH
R _s	Module single lead resistance, terminal to chip		3.6		mΩ

2 Electrical characteristics (curves)

Figure 3. IGBT output characteristics
($V_{GE} = 15\text{ V}$, terminal)

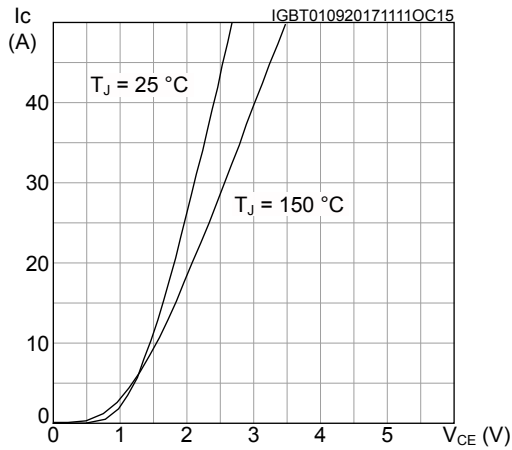

Figure 4. IGBT output characteristics ($T_J = 150\text{ °C}$, terminal)

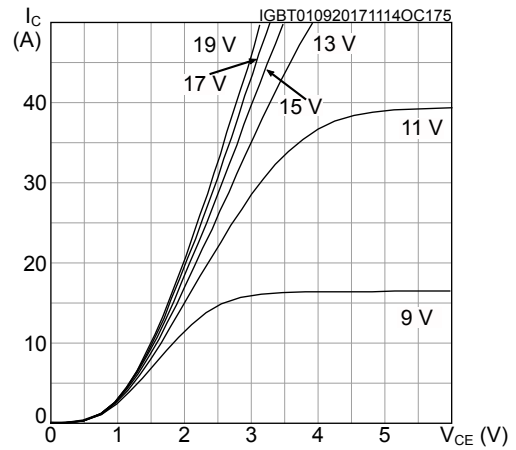

Figure 5. IGBT transfer characteristics
($V_{CE} = 15\text{ V}$, terminal)

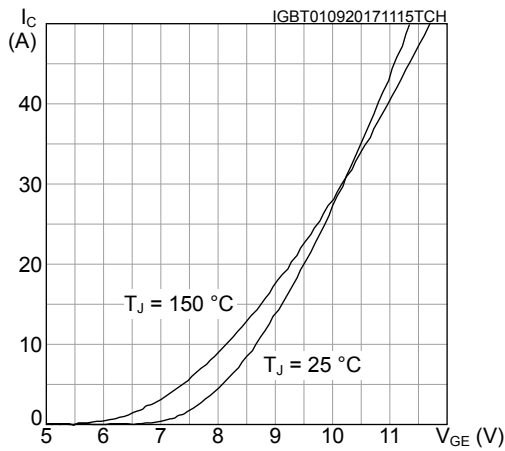

Figure 6. IGBT collector current vs case temperature

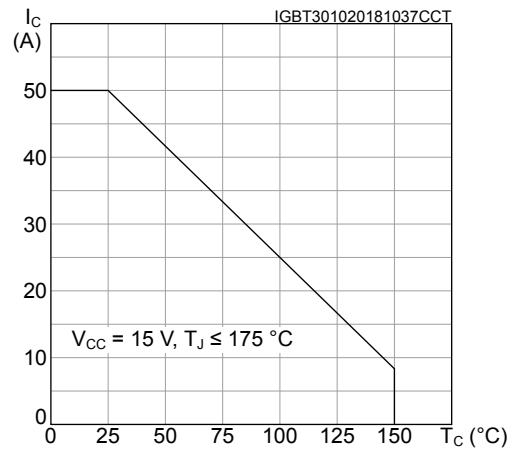

Figure 7. Switching energy vs gate resistance

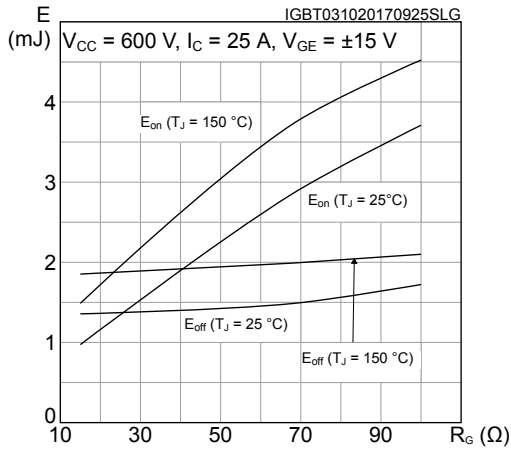

Figure 8. Switching energy vs collector current

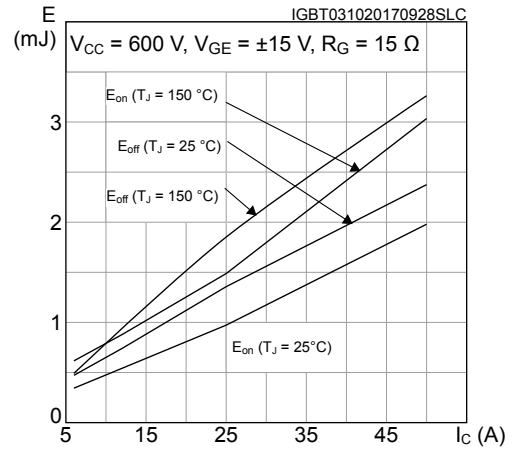

Figure 9. IGBT reverse biased safe operating area (RBSOA)

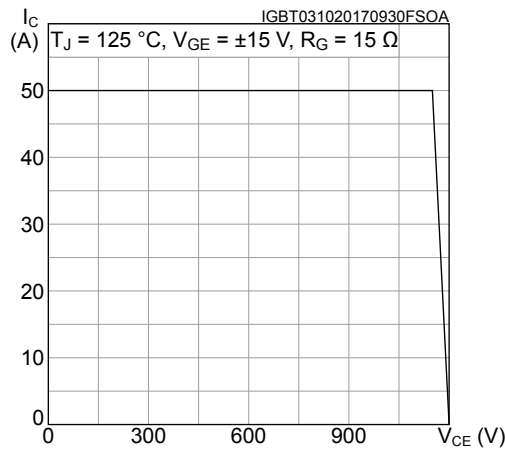

Figure 10. Diode forward characteristics (terminal)

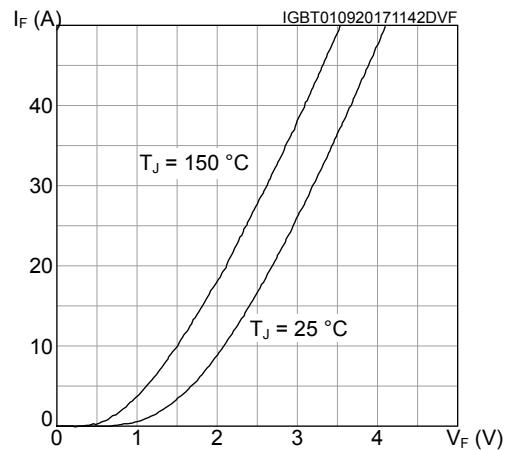

Figure 11. Diode reverse recovery energy vs diode current slope

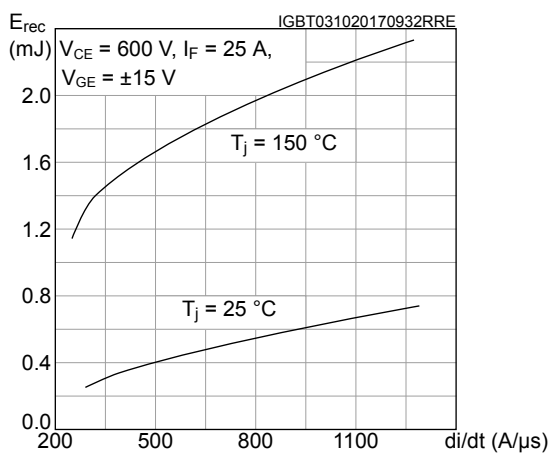

Figure 12. Diode reverse recovery energy vs forward current

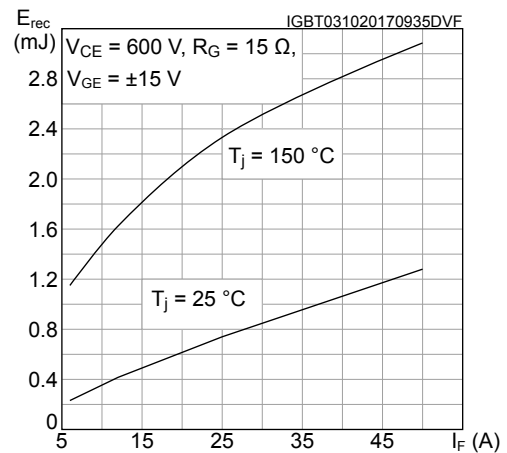

Figure 13. Diode reverse recovery energy vs gate resistance

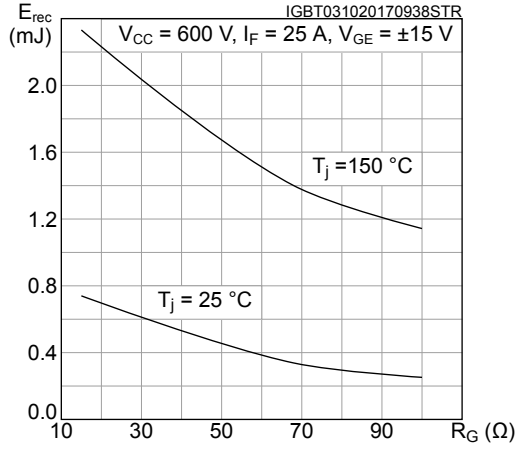

Figure 14. Converter diode forward characteristics (terminal)

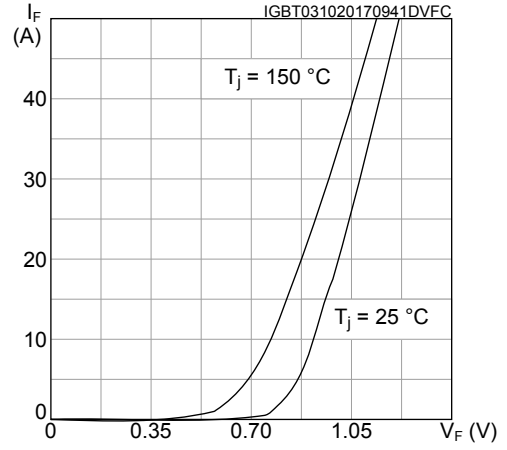

Figure 15. IGBT thermal impedance

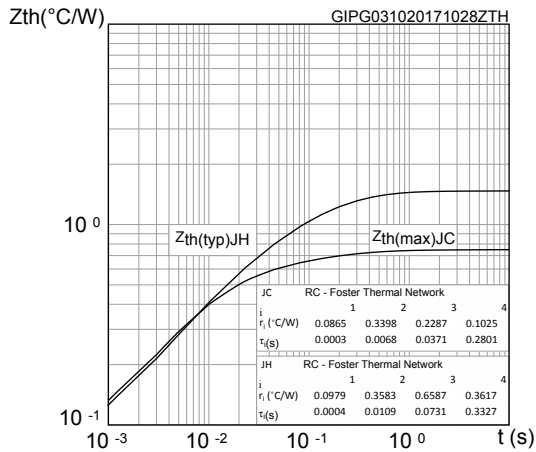
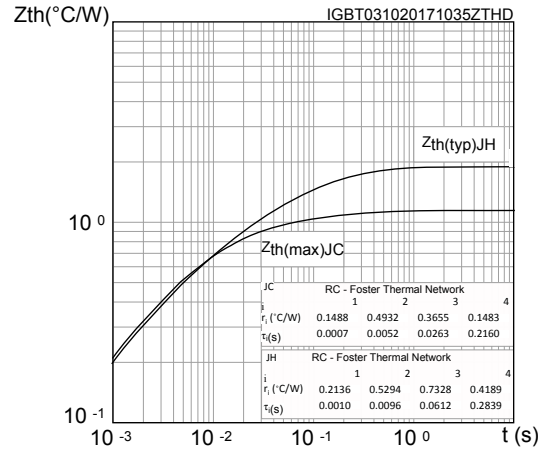

Figure 16. Inverter diode thermal impedance



4 Topology and pin description

Figure 21. Electrical topology and pin description

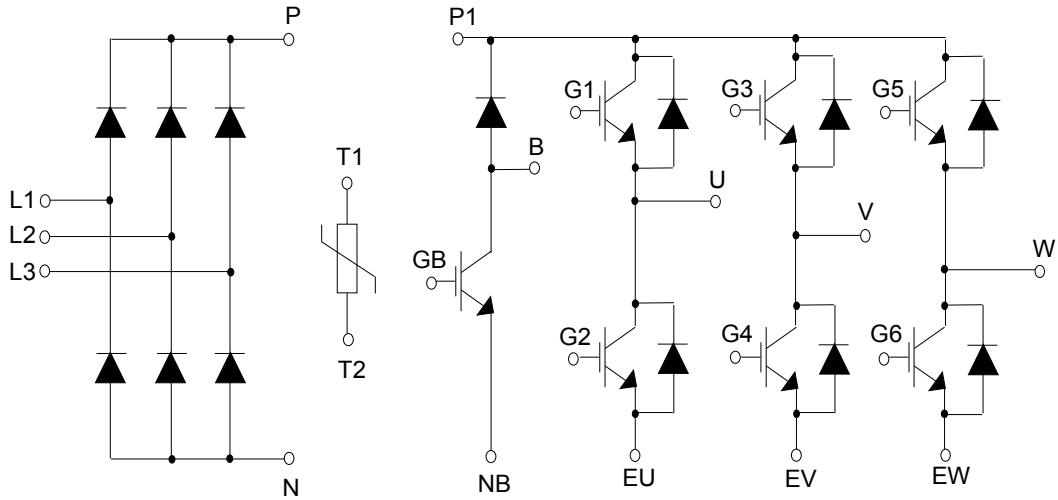
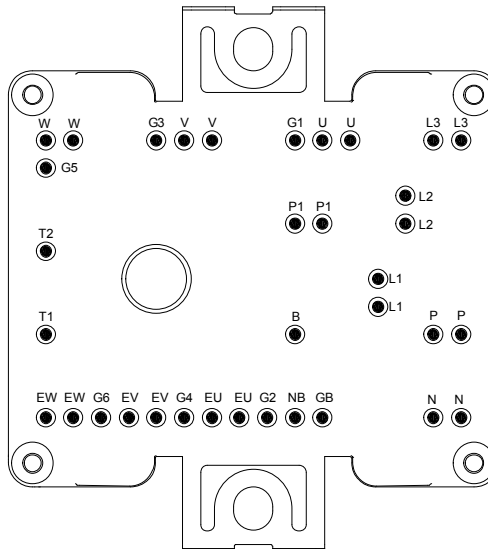

Figure 22. Package top view with CIB pinout



GADG041020170942SA

5 Package information

In order to meet environmental requirements, ST offers these devices in different grades of **ECOPACK[®]** packages, depending on their level of environmental compliance. ECOPACK[®] specifications, grade definitions and product status are available at: www.st.com. ECOPACK[®] is an ST trademark.

5.1 ACEPACK™ 2 CIB press fit contact pins package information

Figure 23. ACEPACK™ 2 CIB press fit contact pins package outline (dimensions are in mm)

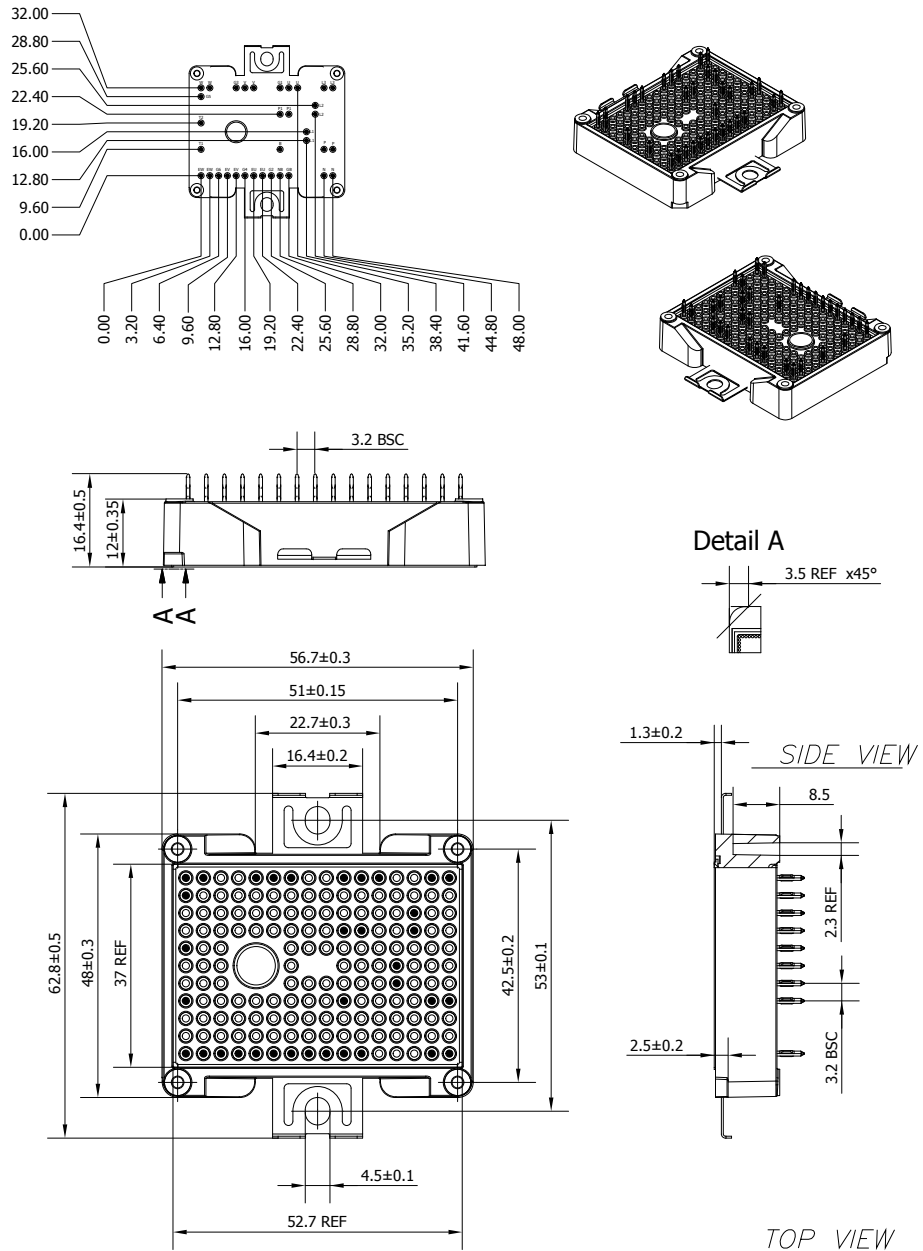

8569722_ACEPACK2_CIB_Press_fit_contact_pins_rev4

- The lead size includes the thickness of the lead plating material.
- Dimensions do not include mold protrusion.
- Package dimensions do not include any eventual metal burrs.

Figure 24. ACEPACK™ 2 CIB press fit contact pins recommended PCB holes layout (dimensions are in mm)

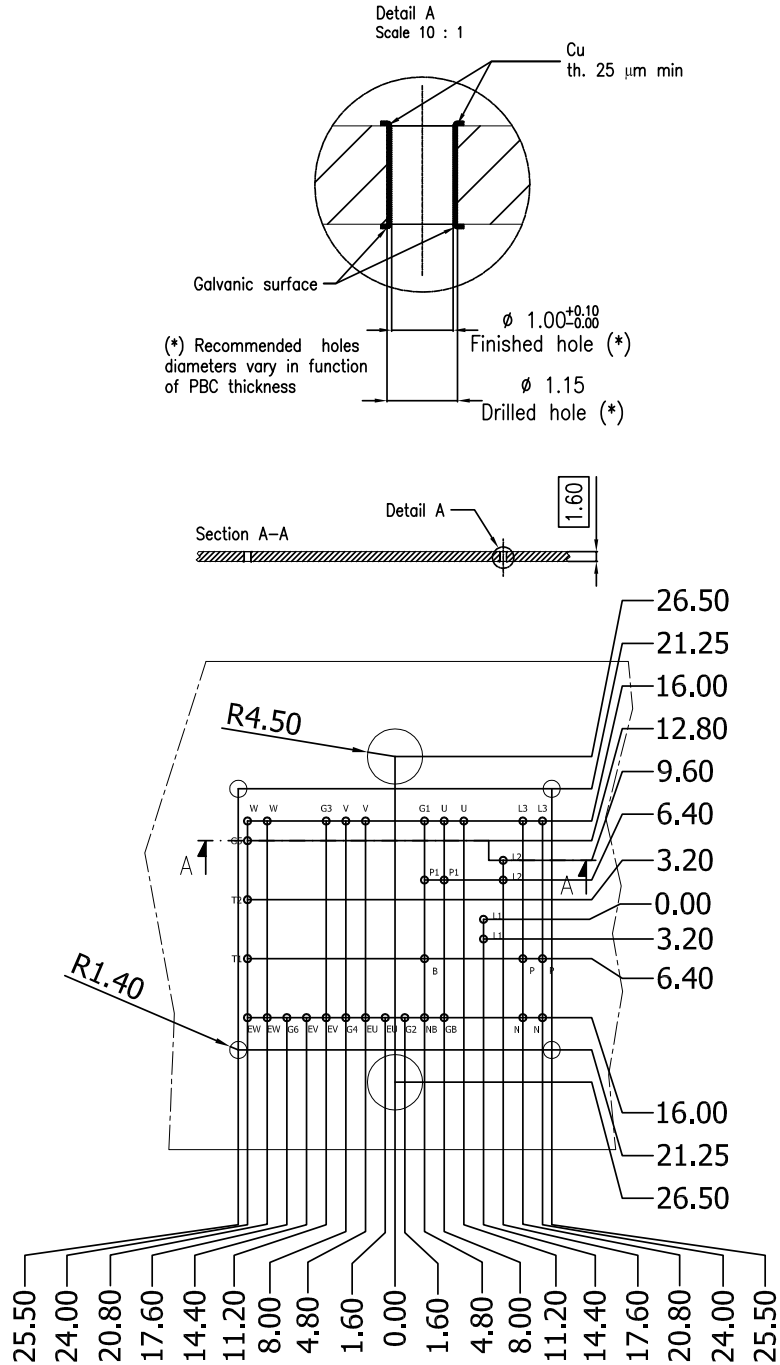

8569722_ACEPACK2_CIB_Press_fit_contact_pins_PCBholes_rev4

Revision history

Table 13. Document revision history

Date	Revision	Changes
02-Oct-2017	1	Initial release.
13-Mar-2018	2	<p>Removed maturity status indication from cover page. The document status is production data.</p> <p>Modified features on cover page.</p> <p>Updated <i>Figure 7. Switching energy vs collector current</i>, <i>Figure 14. IGBT thermal impedance</i> and <i>Figure 15. Inverter diode thermal impedance</i>.</p> <p>Updated <i>Section 5.1 ACEPACK™ 2 CIB press fit contact pins package information</i>.</p> <p>Minor text changes.</p>
14-Nov-2018	3	<p>Added Figure 6. IGBT collector current vs case temperature.</p> <p>Minor text changes</p>

Contents

1	Electrical ratings	2
1.1	Inverter stage	2
1.1.1	IGBTs	2
1.1.2	Diode	3
1.2	Brake stage	4
1.2.1	IGBT	4
1.2.2	Diode	5
1.3	Converter stage	6
1.4	NTC	7
1.5	Package	7
2	Electrical characteristics (curves)	8
3	Test circuits	11
4	Topology and pin description	12
5	Package information	13
5.1	ACEPACK™ 2 CIB press fit contact pins package information	14
	Revision history	16