

# AC axial fans

A-Range, Ø 200



- **Material:** sheet steel (coated in black)
- **Direction of rotation:** direction of air flow "V" counter-clockwise, direction of air flow "A" clockwise
- **Type of protection:** IP 44

ebm-papst • Muldingen

Nominal data		Characteristic	Voltage	Frequency	Air flow	Speed/rpm	Power input	Current draw	Capacitor	Sound pressure level	Max. back pressure	Perm. amb. temp.	Mass
Type	Motor	VAC	Hz	m³/h	min⁻¹	W	A	µF/VDB	dB(A)	Pa	°C	kg	
*2D 200 <sup>(1)</sup>	M2D068-CF	① 230/400	50	830	2800	53	0,15	---	67	140	75	1,7	
		230/400	60	940	3150	70	0,14	---	70	140	75		
*2E 200	M2E068-CA	② 230	50	740	2740	50	0,24	1,5/400	65	200	75	1,4	
		230	60	830	3120	61	0,28	1,5/400	69	200	75		
*4D 200 <sup>(1)</sup>	M4D068-CF	③ 230/400	50	390	1450	22	0,09	---	51	70	60	1,5	
		230/400	60	460	1730	21	0,07	---	55	100	80		
*4S 200	M4S068-BF	④ 230	50	375	1380	40	0,30	---	52	60	50	1,2	
		230	60	445	1630	34	0,24	---	53	80	65		

subject to alterations

<sup>(1)</sup> current draw established at 400 VAC (V)

	n [min <sup>-1</sup> ]	P <sub>1</sub> [W]
① ①	2785	53
① ②	2770	55
② ①	2670	51
② ②	2670	50

	n [min <sup>-1</sup> ]	P <sub>1</sub> [W]
③ ①	1460	24
③ ②	1460	24
④ ①	1375	40
④ ②	1380	39

## Characteristics

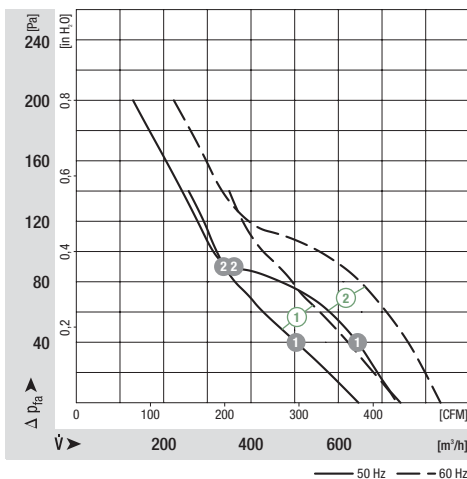

## Characteristics

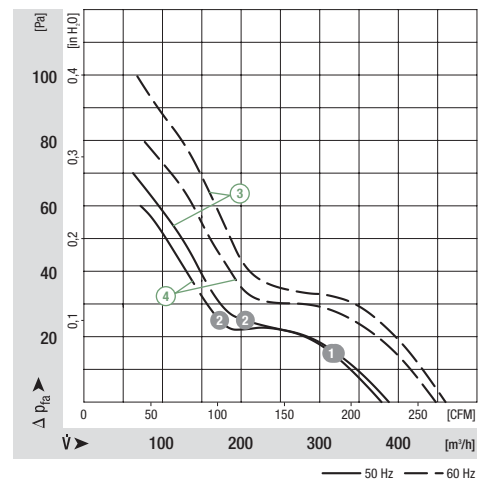

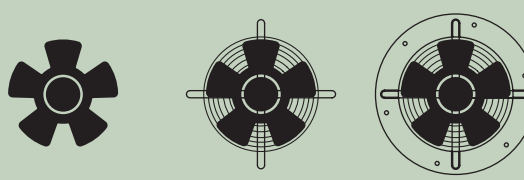
Selection	Cable exit	Direction of air flow				Dimensions	
						Type	S/A/B
*2D 200	S	"V"	A2D200-AA02 -01	S2D200-BA02 -01	W2D200-CA02 -01	21	
		"A"	A2D200-AA02 -02	S2D200-BA02 -02	W2D200-CA02 -02	21	
*2E 200	B	"V"	A2E 200-AF02 -01	S2E 200-BF02 -01	W2E 200-CF02 -01	21	
		"A"	A2E 200-AF02 -02	S2E 200-BF02 -02	W2E 200-CF02 -02	21	
*4D 200	S	"V"	A4D200-AA04 -01	S4D200-BA04 -01	W4D200-CA04 -01	20	
		"A"	A4D200-AA04 -02	S4D200-BA04 -02	W4D200-CA04 -02	20	
*4S 200	S	"V"	A4S 200-AA02 -01	S4S 200-BA02 -01	W4S 200-CA02 -01	20	
		"A"	A4S 200-AA02 -02	S4S 200-BA02 -02	W4S 200-CA02 -02	20	

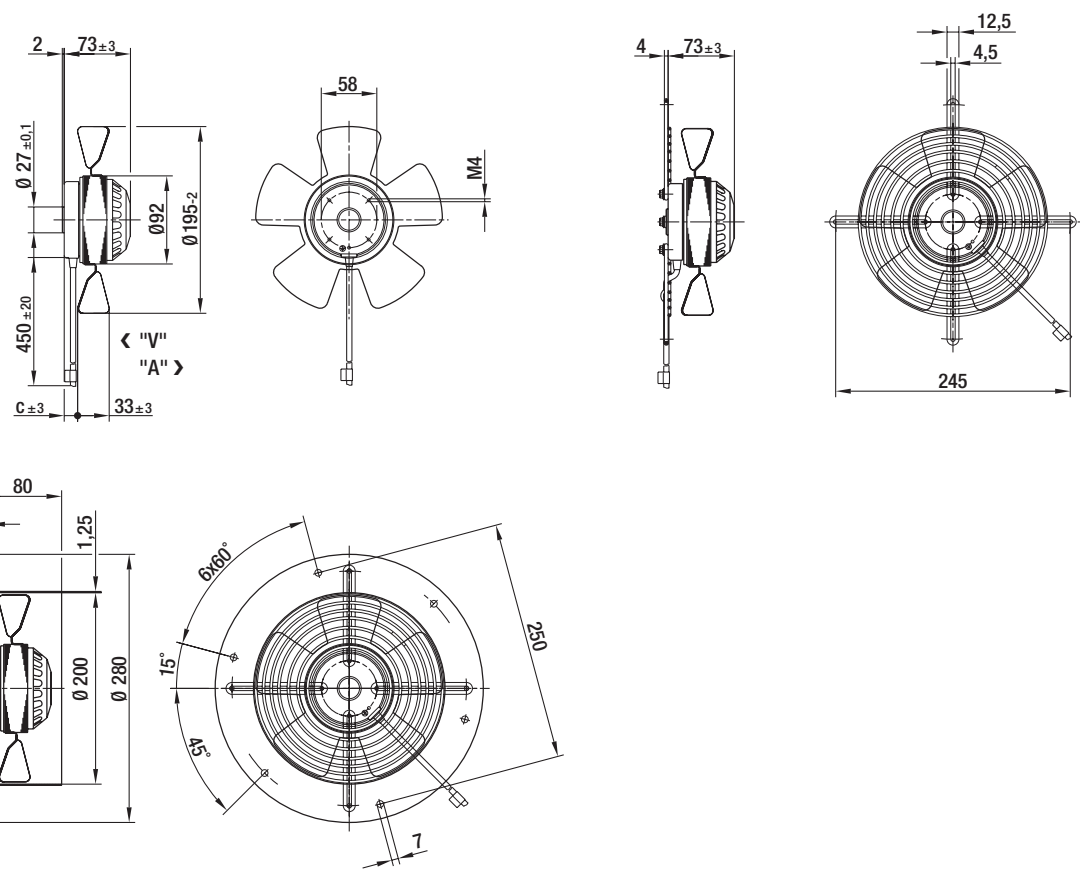

# AC axial fans

A-Range, Ø 250



- **Material:** sheet steel (coated in black)
- **Direction of rotation:** direction of air flow "V" counter-clockwise, direction of air flow "A" clockwise
- **Type of protection:** IP 44

ebm-papst • Muldingen

Nominal data		Characteristic	Voltage	Frequency	Air flow	Speed/rpm	Power input	Current draw	Capacitor	Sound pressure level	Max. back pressure	Perm. amb. temp.	Mass
Type	Motor	VAC	Hz	m³/h	min⁻¹	W	A	µF/VDB	dB(A)	Pa	°C	kg	
*2D 250 <sup>(1)</sup>	M2D068-DF	① 230/400	50	1685	2650	110	0,22	---	72	300	70	2,2	
		230/400	60	1845	2950	160	0,26	---	75	300	40		
*2E 250	M2E068-DF	② 230	50	1610	2550	115	0,51	4,0/400	72	150	55	2,2	
		230	60	1740	2750	165	0,74	4,0/400	73	130	50		
*4D 250 <sup>(1)</sup>	M4D068-CF	③ 230/400	50	890	1420	30	0,09	---	58	90	75	1,6	
		230/400	60	1035	1650	35	0,08	---	62	100	75		
*4S 250	M4S068-CF	④ 230	50	870	1400	72	0,53	---	58	80	40	1,7	
		230	60	1000	1620	67	0,46	---	62	100	50		

subject to alterations

<sup>(1)</sup> current draw established at 400 VAC (V)

	n [min <sup>-1</sup> ]	P <sub>1</sub> [W]
① ①	2645	123
① ②	2615	131
② ①	2520	122
② ②	2480	126

	n [min <sup>-1</sup> ]	P <sub>1</sub> [W]
③ ①	1420	32
③ ②	1410	33
④ ①	1400	70
④ ②	1395	71

## Characteristics

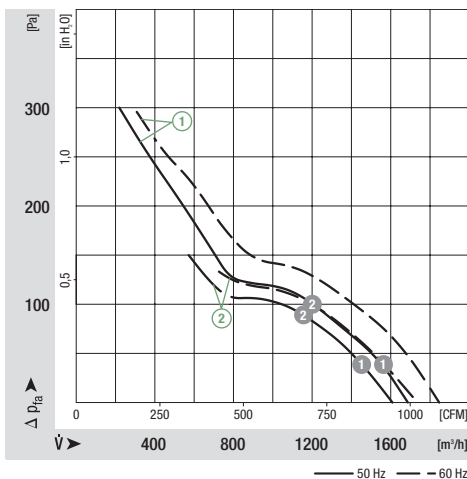

## Characteristics

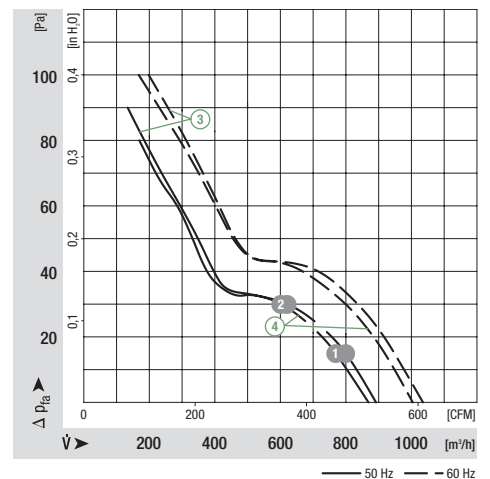

Selection	Cable exit	Direction of air flow	Fan models			Dimensions	
			Type	S/A/B		a	c
*2D 250	S	"V" "A"	A2D250-AA02 -01	S2D250-BA02 -01	W2D250-CA02 -01	83	27
			A2D250-AA02 -02	S2D250-BA02 -02	W2D250-CA02 -02	83	27
*2E 250	B	"V" "A"	A2E250-AE65 -01	S2E250-BE65 -01	W2E250-CE65 -01	83	27
			A2E250-AE65 -02	S2E250-BE65 -02	W2E250-CE65 -02	83	27
*4D 250	S	"V" "A"	A4D250-AA04 -01	S4D250-BA04 -01	W4D250-CA04 -01	73	19
			A4D250-AA04 -02	S4D250-BA04 -02	W4D250-CA04 -02	73	19
*4S 250	S	"V" "A"	A4S250-AA02 -01	S4S250-BA02 -01	W4S250-CA02 -01	73	19
			A4S250-AA02 -02	S4S250-BA02 -02	W4S250-CA02 -02	73	19

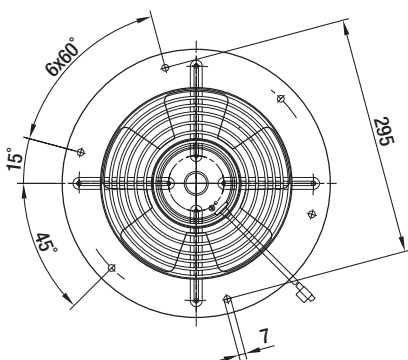
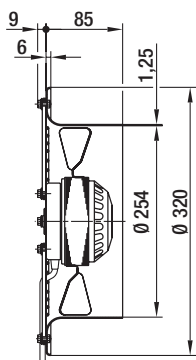
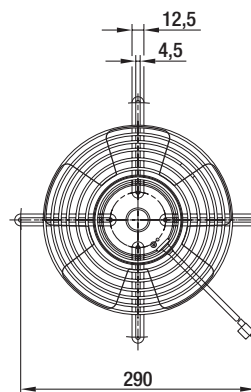
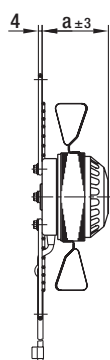
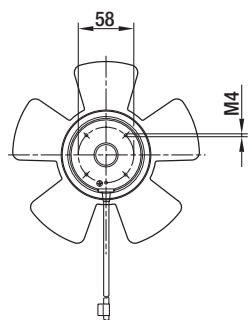
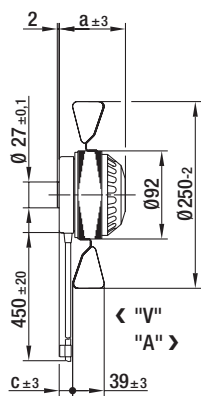

# AC axial fans

A-Range, Ø 300



- **Material:** sheet steel (coated in black)
- **Direction of rotation:** direction of air flow "V" counter-clockwise, direction of air flow "A" clockwise
- **Type of protection:** IP 44

ebm-papst • Muldingen

Nominal data		Characteristic	Voltage	Frequency	Air flow	Speed/rpm	Power input	Current draw	Capacitor	Sound pressure level	Max. back pressure	Perm. amb. temp.	Mass
Type	Motor	VAC	Hz	m³/h	min⁻¹	W	A	µF/VDB	dB(A)	Pa	°C	kg	
*2D 300 <sup>(1)</sup>	M2D068-EC	① 230/400	50	2760	2650	180	0,31	---	76	150	60	2,7	
		230/400	60	2940	2800	270	0,41	---	77	100	40		
*2E 300	M2E068-EC	② 230	50	2440	2650	140	0,62	5,0/400	75	150	55	2,5	
		230	60	2700	2900	190	0,83	5,0/400	78	150	50		
*4D 300 <sup>(1)</sup>	M4D068-DF	③ 230/400	50	1740	1370	85	0,21	---	66	100	55	2,3	
		230/400	60	1910	1520	110	0,22	---	68	110	40		
*4E 300	M4E068-DF	④ 230	50	1690	1350	95	0,44	3,0/400	65	120	45	2,3	
		230	60	1830	1450	105	0,47	2,0/400	66	100	40		
*4S 300	M4S068-DF	⑤ 230	50	1440	1380	94	0,67	---	62	75	30	2,1	
		230	60	1600	1550	94	0,67	---	64	60	40		

subject to alterations

<sup>(1)</sup> current draw established at 400 VAC (V)

	n [min⁻¹]	P <sub>1</sub> [W]
① ①	2610	190
① ②	2535	220
② ①	2600	149
② ②	2530	162

	n [min⁻¹]	P <sub>1</sub> [W]
③ ①	1360	86
③ ②	1345	94
④ ①	1345	96
④ ②	1315	101
⑤ ①	1375	92
⑤ ②	1360	94

## Characteristics

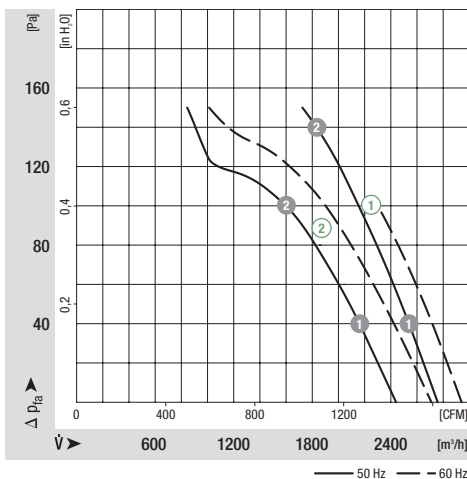

## Characteristics

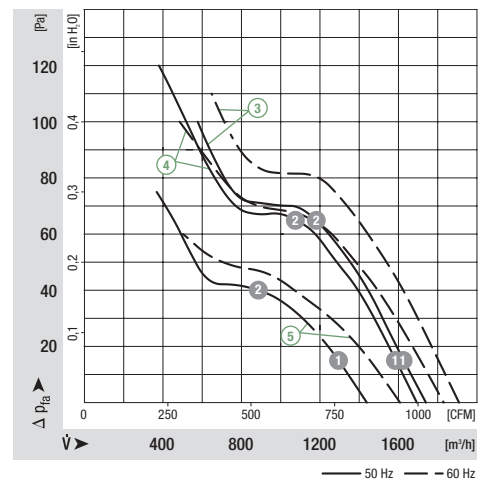

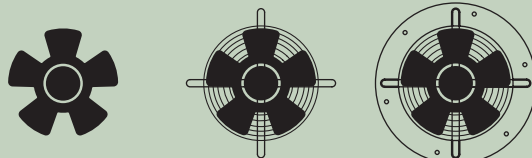
Selection	Cable exit	Direction of air flow				Dimensions			
						a	b	c	h
Type	S/A/B								
*2D 300	S	"V"	A2D300-AD02 -01	S2D300-BD02 -01	W2D300-CD02 -01	101	30	32	64
		"A"	A2D300-AD02 -02	S2D300-BD02 -02	W2D300-CD02 -02	101	30	32	64
*2E 300	S	"V"	A2E 300-AC47 -01	S2E 300-BC47 -01	W2E 300-CC47 -01	98	20	30	50
		"A"	A2E 300-AC47 -02	S2E 300-BC47 -02	W2E 300-CC47 -02	98	20	30	37
*4D 300	S	"V"	A4D300-AA02 -01	S4D300-BA02 -01	W4D300-CA02 -01	83	56	20	73
		"A"	A4D300-AA02 -02	S4D300-BA02 -02	W4D300-CA02 -02	83	56	20	73
*4E 300	S	"V"	A4E 300-AA01 -01	S4E 300-BA01 -01	W4E 300-CA01 -01	83	56	20	73
		"A"	A4E 300-AA01 -02	S4E 300-BA01 -02	W4E 300-CA01 -02	83	56	20	73
*4S 300	S	"V"	A4S 300-AA02 -01	S4S 300-BA02 -01	W4S 300-CA02 -01	83	30	20	52
		"A"	A4S 300-AA02 -02	S4S 300-BA02 -02	W4S 300-CA02 -02	83	30	20	52

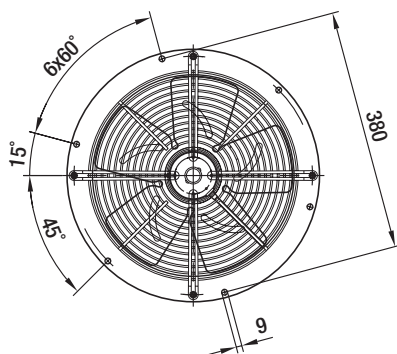
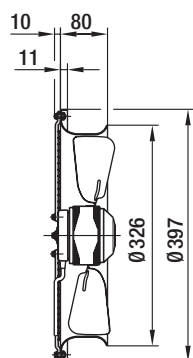
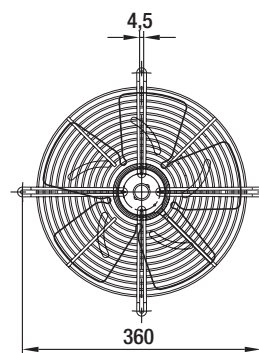
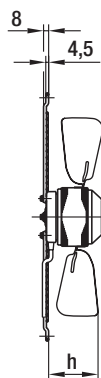
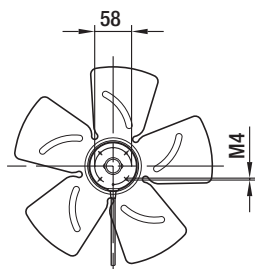
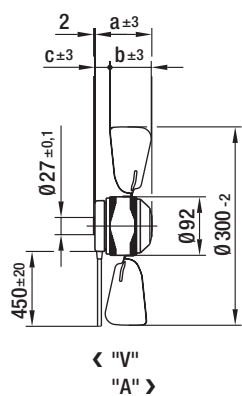

# AC axial fans

A-Range, Ø 315



- **Material:** sheet steel (coated in black)
- **Direction of rotation:** direction of air flow "V" counter-clockwise, direction of air flow "A" clockwise
- **Type of protection:** IP 44

ebm-papst • Muldingen

Nominal data		Characteristic	Voltage	Frequency	Air flow	Speed/rpm	Power input	Current draw	Capacitor	Sound pressure level	Max. back pressure	Perm. amb. temp.	Mass
Type	Motor		VAC	Hz	m³/h	min⁻¹	W	A	µF/VDB	dB(A)	Pa	°C	kg
*4D 315 <sup>(1)</sup>	M4D068-EC	①	230/400	50	1990	1400	78	0,19	---	65	150	80	2,8
			230/400	60	2260	1590	115	0,21	---	68	150	60	
*4E 315 <sup>(2)</sup>	M4E068-EC	②	230	50	1950	1400	120	0,53	5,0/400	67	180	50	2,8
			230	60	2230	1610	135	0,60	4,0/400	70	120	45	

subject to alterations

<sup>(1)</sup> current draw established at 400 VAC (Y)

<sup>(2)</sup> insulation class "F"

	n [min⁻¹]	P <sub>1</sub> [W]
① ①	1390	82
① ②	1370	95
② ①	1395	123
② ②	1360	136

## Characteristics

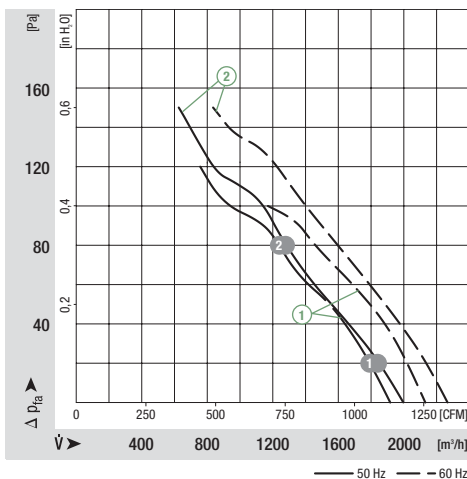

Selection	Cable exit	Direction of air flow	Dimensions			
Type	S/A/B		a			
*4D 315	S	"V"	A4D315-AC20 -01	S4D315-BC20 -01	W4D315-CC20 -01	101
		"A"	A4D315-AC20 -02	S4D315-BC20 -02	W4D315-CC20 -02	101
*4E 315	S	"V"	A4E 315-AA05 -01	S4E 315-BA05 -01	W4E 315-CA05 -01	92
		"A"	A4E 315-AA05 -02	S4E 315-BA05 -02	W4E 315-CA05 -02	92

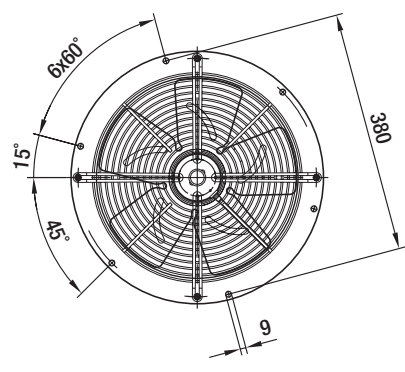
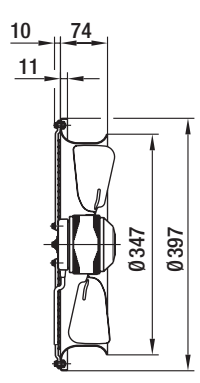
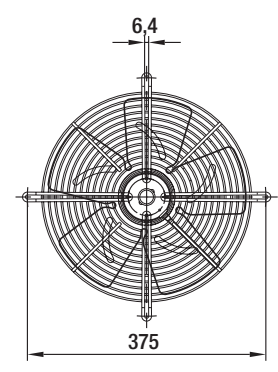
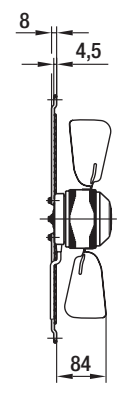
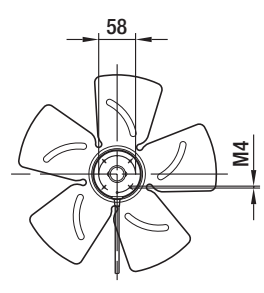
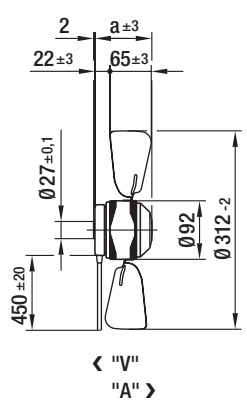



# AC axial fans

A-Range, Ø 350



- **Material:** sheet steel (coated in black)
- **Direction of rotation:** direction of air flow "V" counter-clockwise, direction of air flow "A" clockwise
- **Type of protection:** IP 44

ebm-papst • Muldingen

Nominal data		Characteristic	Voltage	Frequency	Air flow	Speed/rpm	Power input	Current draw	Capacitor	Sound pressure level	Max. back pressure	Perm. amb. temp.	Mass
Type	Motor		VAC	Hz	m³/h	min⁻¹	W	A	µF/VDB	dB(A)	Pa	°C	kg
*4D 350 <sup>(1)</sup>	M4D068-EC	①	230/400	50	2900	1420	145	0,39	---	69	150	45	3,1
			230/400	60	3300	1620	190	0,36	---	72	150	40	
*4E 350	M4E068-EC	②	230	50	2850	1390	140	0,62	5,0/400	68	120	60	3,1
			230	60	3190	1550	195	0,86	5,0/400	70	90	40	



subject to alterations

<sup>(1)</sup> current draw established at 400 VAC (Y)

	n [min <sup>-1</sup> ]	P <sub>1</sub> [W]
① ①	1405	154
① ②	1390	169
② ①	1375	147
② ②	1345	161

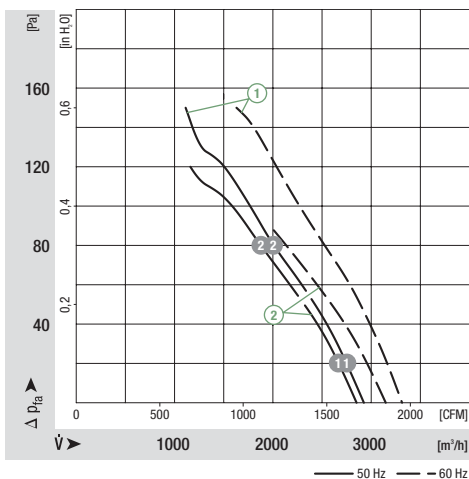
## Characteristics

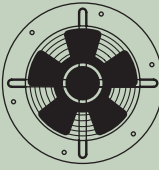

Selection	Cable exit	Direction of air flow			
Type	S/A/B				
*4D 350	S	"V"	A4D350-AA06 -01	S4D350-BA06 -01	W4D350-CA06 -01
		"A"	A4D350-AA06 -02	S4D350-BA06 -02	W4D350-CA06 -02
*4E 350	S	"V"	A4E350-AA06 -01	S4E350-BA06 -01	W4E350-CA06 -01
		"A"	A4E350-AA06 -02	S4E350-BA06 -02	W4E350-CA06 -02

