



# RF LDMOS Wideband Integrated Power Amplifiers

The A2I20H060N wideband integrated circuit is an asymmetrical Doherty designed with on-chip matching that makes it usable from 1800 to 2200 MHz. This multi-stage structure is rated for 26 to 32 V operation and covers all typical cellular base station modulation formats.

## 1800 MHz

- Typical Doherty Single-Carrier W-CDMA Characterization Performance:  $V_{DD} = 28$  Vdc,  $I_{DQ1A} = 24$  mA,  $I_{DQ2A} = 145$  mA,  $V_{GS1B} = 1.65$  Vdc,  $V_{GS2B} = 1.3$  Vdc,  $P_{out} = 12$  W Avg., Input Signal PAR = 9.9 dB @ 0.01% Probability on CCDF. (1)

Frequency	$G_{ps}$ (dB)	PAE (%)	ACPR (dBc)
1805 MHz	28.5	42.7	-37.4
1840 MHz	28.4	43.8	-37.8
1880 MHz	28.1	43.1	-34.7

## 2100 MHz

- Typical Doherty Single-Carrier W-CDMA Performance:  $V_{DD} = 28$  Vdc,  $I_{DQ1A} = 24$  mA,  $I_{DQ2A} = 145$  mA,  $V_{GS1B} = 1.65$  Vdc,  $V_{GS2B} = 1.3$  Vdc,  $P_{out} = 12$  W Avg., Input Signal PAR = 9.9 dB @ 0.01% Probability on CCDF. (1)

Frequency	$G_{ps}$ (dB)	PAE (%)	ACPR (dBc)
2110 MHz	27.8	42.3	-36.0
2140 MHz	27.5	42.2	-38.3
2170 MHz	27.3	42.2	-37.7

## Features

- Advanced High Performance In-Package Doherty
- On-Chip Matching (50 Ohm Input, DC Blocked)
- Integrated Quiescent Current Temperature Compensation with Enable/Disable Function (2)
- Designed for Digital Predistortion Error Correction Systems

**A2I20H060NR1**  
**A2I20H060GNR1**

**1800–2200 MHz, 12 W AVG., 28 V AIRFAST RF LDMOS WIDEBAND INTEGRATED POWER AMPLIFIERS**

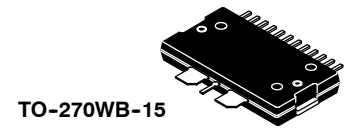

TO-270WB-15  
 PLASTIC  
 A2I20H060NR1

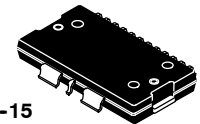

TO-270WBG-15  
 PLASTIC  
 A2I20H060GNR1

1. All data measured in fixture with device soldered to heatsink.

2. Refer to AN1977, *Quiescent Current Thermal Tracking Circuit in the RF Integrated Circuit Family*, and to AN1987, *Quiescent Current Control for the RF Integrated Circuit Device Family*. Go to <http://www.nxp.com/RF> and search for AN1977 or AN1987.

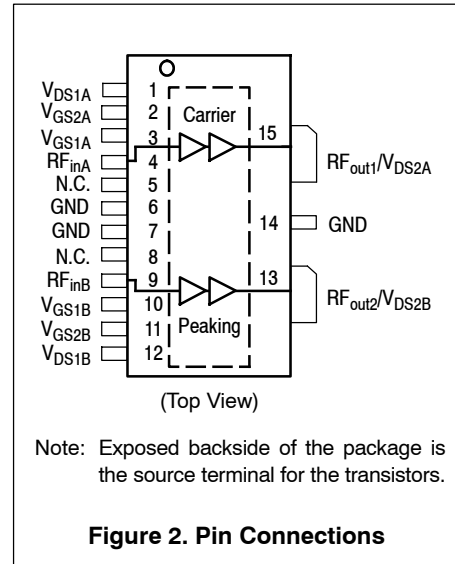
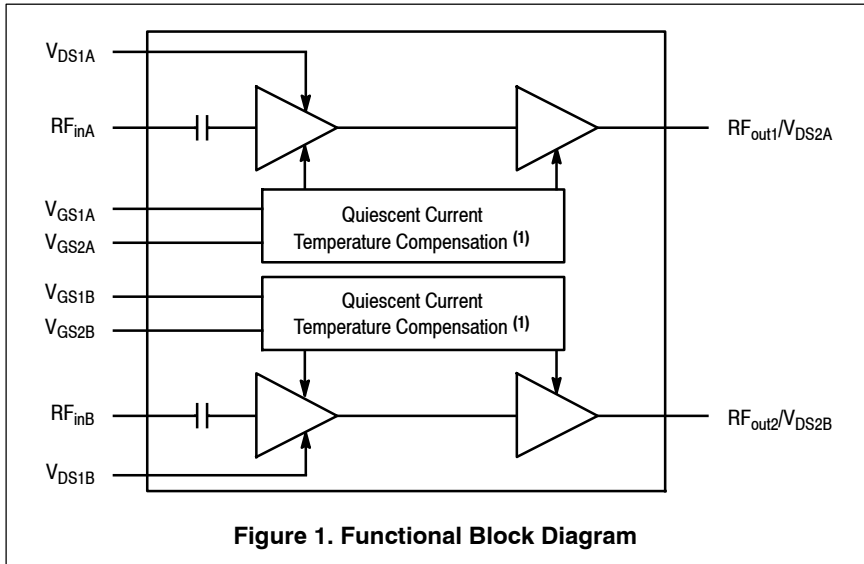

**Table 1. Maximum Ratings**

Rating	Symbol	Value	Unit
Drain-Source Voltage	$V_{DSS}$	-0.5, +65	Vdc
Gate-Source Voltage	$V_{GS}$	-0.5, +10	Vdc
Operating Voltage	$V_{DD}$	32, +0	Vdc
Storage Temperature Range	$T_{stg}$	-65 to +150	°C
Case Operating Temperature Range	$T_C$	-40 to +150	°C
Operating Junction Temperature Range (2,3)	$T_J$	-40 to +225	°C
Input Power	$P_{in}$	20	dBm

**Table 2. Thermal Characteristics**

Characteristic	Symbol	Value (3,4)	Unit
Thermal Resistance, Junction to Case Case Temperature 73°C, 12 W Avg., W-CDMA, 1840 MHz Stage 1, 28 Vdc, $I_{DQ1A} = 24$ mA, $V_{GS1B} = 1.65$ Vdc Stage 2, 28 Vdc, $I_{DQ2A} = 145$ mA, $V_{GS2B} = 1.3$ Vdc	$R_{\theta JC}$	5.2 1.6	°C/W

**Table 3. ESD Protection Characteristics**

Test Methodology	Class
Human Body Model (per JESD22-A114)	1C
Machine Model (per EIA/JESD22-A115)	A
Charge Device Model (per JESD22-C101)	III

**Table 4. Moisture Sensitivity Level**

Test Methodology	Rating	Package Peak Temperature	Unit
Per JESD22-A113, IPC/JEDEC J-STD-020	3	260	°C

1. Refer to AN1977, *Quiescent Current Thermal Tracking Circuit in the RF Integrated Circuit Family*, and to AN1987, *Quiescent Current Control for the RF Integrated Circuit Device Family*. Go to <http://www.nxp.com/RF> and search for AN1977 or AN1987.
2. Continuous use at maximum temperature will affect MTTF.
3. MTTF calculator available at <http://www.nxp.com/RF/calculators>.
4. Refer to AN1955, *Thermal Measurement Methodology of RF Power Amplifiers*. Go to <http://www.nxp.com/RF> and search for AN1955.

**Table 5. Electrical Characteristics** ( $T_A = 25^\circ\text{C}$  unless otherwise noted)

Characteristic	Symbol	Min	Typ	Max	Unit
<b>Carrier Stage 1 - Off Characteristics</b> <sup>(1)</sup>					
Zero Gate Voltage Drain Leakage Current ( $V_{DS} = 65\text{ Vdc}$ , $V_{GS} = 0\text{ Vdc}$ )	$I_{DSS}$	—	—	10	$\mu\text{Adc}$
Zero Gate Voltage Drain Leakage Current ( $V_{DS} = 32\text{ Vdc}$ , $V_{GS} = 0\text{ Vdc}$ )	$I_{DSS}$	—	—	1	$\mu\text{Adc}$
Gate-Source Leakage Current ( $V_{GS} = 1.0\text{ Vdc}$ , $V_{DS} = 0\text{ Vdc}$ )	$I_{GSS}$	—	—	1	$\mu\text{Adc}$
<b>Carrier Stage 1 - On Characteristics</b>					
Gate Threshold Voltage <sup>(1)</sup> ( $V_{DS} = 10\text{ Vdc}$ , $I_D = 3\ \mu\text{Adc}$ )	$V_{GS(th)}$	0.8	1.3	1.6	Vdc
Gate Quiescent Voltage ( $V_{DS} = 28\text{ Vdc}$ , $I_{DQ1A} = 24\text{ mAdc}$ )	$V_{GS(Q)}$	—	2.2	—	Vdc
Fixture Gate Quiescent Voltage ( $V_{DD} = 28\text{ Vdc}$ , $I_{DQ1A} = 24\text{ mAdc}$ , Measured in Functional Test)	$V_{GG(Q)}$	3.4	4.4	4.9	Vdc
<b>Carrier Stage 2 - Off Characteristics</b> <sup>(1)</sup>					
Zero Gate Voltage Drain Leakage Current ( $V_{DS} = 65\text{ Vdc}$ , $V_{GS} = 0\text{ Vdc}$ )	$I_{DSS}$	—	—	10	$\mu\text{Adc}$
Zero Gate Voltage Drain Leakage Current ( $V_{DS} = 32\text{ Vdc}$ , $V_{GS} = 0\text{ Vdc}$ )	$I_{DSS}$	—	—	1	$\mu\text{Adc}$
Gate-Source Leakage Current ( $V_{GS} = 1.0\text{ Vdc}$ , $V_{DS} = 0\text{ Vdc}$ )	$I_{GSS}$	—	—	1	$\mu\text{Adc}$
<b>Carrier Stage 2 - On Characteristics</b>					
Gate Threshold Voltage <sup>(1)</sup> ( $V_{DS} = 10\text{ Vdc}$ , $I_D = 24\ \mu\text{Adc}$ )	$V_{GS(th)}$	0.8	1.3	1.6	Vdc
Gate Quiescent Voltage ( $V_{DS} = 28\text{ Vdc}$ , $I_{DQ2A} = 145\text{ mAdc}$ )	$V_{GS(Q)}$	—	1.8	—	Vdc
Fixture Gate Quiescent Voltage ( $V_{DD} = 28\text{ Vdc}$ , $I_{DQ2A} = 145\text{ mAdc}$ , Measured in Functional Test)	$V_{GG(Q)}$	2.7	3.7	4.2	Vdc
Drain-Source On-Voltage <sup>(1)</sup> ( $V_{GS} = 10\text{ Vdc}$ , $I_D = 280\text{ mAdc}$ )	$V_{DS(on)}$	0.1	0.34	1.5	Vdc

1. Each side of device measured separately.

(continued)

**Table 5. Electrical Characteristics** ( $T_A = 25^\circ\text{C}$  unless otherwise noted) **(continued)**

Characteristic	Symbol	Min	Typ	Max	Unit
<b>Peaking Stage 1 - Off Characteristics</b> <sup>(1)</sup>					
Zero Gate Voltage Drain Leakage Current ( $V_{DS} = 65\text{ Vdc}$ , $V_{GS} = 0\text{ Vdc}$ )	$I_{DSS}$	—	—	10	$\mu\text{Adc}$
Zero Gate Voltage Drain Leakage Current ( $V_{DS} = 32\text{ Vdc}$ , $V_{GS} = 0\text{ Vdc}$ )	$I_{DSS}$	—	—	1	$\mu\text{Adc}$
Gate-Source Leakage Current ( $V_{GS} = 1.0\text{ Vdc}$ , $V_{DS} = 0\text{ Vdc}$ )	$I_{GSS}$	—	—	1	$\mu\text{Adc}$
<b>Peaking Stage 1 - On Characteristics</b> <sup>(1)</sup>					
Gate Threshold Voltage ( $V_{DS} = 10\text{ Vdc}$ , $I_D = 8\ \mu\text{Adc}$ )	$V_{GS(th)}$	0.8	1.3	1.6	Vdc
<b>Peaking Stage 2 - Off Characteristics</b> <sup>(1)</sup>					
Zero Gate Voltage Drain Leakage Current ( $V_{DS} = 65\text{ Vdc}$ , $V_{GS} = 0\text{ Vdc}$ )	$I_{DSS}$	—	—	10	$\mu\text{Adc}$
Zero Gate Voltage Drain Leakage Current ( $V_{DS} = 32\text{ Vdc}$ , $V_{GS} = 0\text{ Vdc}$ )	$I_{DSS}$	—	—	1	$\mu\text{Adc}$
Gate-Source Leakage Current ( $V_{GS} = 1.0\text{ Vdc}$ , $V_{DS} = 0\text{ Vdc}$ )	$I_{GSS}$	—	—	1	$\mu\text{Adc}$
<b>Peaking Stage 2 - On Characteristics</b> <sup>(1)</sup>					
Gate Threshold Voltage ( $V_{DS} = 10\text{ Vdc}$ , $I_D = 40\ \mu\text{Adc}$ )	$V_{GS(th)}$	0.8	1.3	1.6	Vdc
Drain-Source On-Voltage ( $V_{GS} = 10\text{ Vdc}$ , $I_D = 350\text{ mAdc}$ )	$V_{DS(on)}$	0.1	0.17	1.5	Vdc

1. Each side of device measured separately.

(continued)

**Table 5. Electrical Characteristics** ( $T_A = 25^\circ\text{C}$  unless otherwise noted) (continued)

Characteristic	Symbol	Min	Typ	Max	Unit
<b>Functional Tests</b> <sup>(1,2,3)</sup> (In Freescale Doherty Production Test Fixture, 50 ohm system) $V_{DD} = 28\text{ Vdc}$ , $I_{DQ1A} = 24\text{ mA}$ , $I_{DQ2A} = 145\text{ mA}$ , $V_{GS1B} = 1.65\text{ Vdc}$ , $V_{GS2B} = 1.3\text{ Vdc}$ , $P_{out} = 12\text{ W Avg.}$ , $f = 1842.5\text{ MHz}$ , Single-Carrier W-CDMA, IQ Magnitude Clipping, Input Signal PAR = 9.9 dB @ 0.01% Probability on CCDF. ACPR measured in 3.84 MHz Channel Bandwidth @ $\pm 5\text{ MHz}$ Offset.					
Power Gain	$G_{ps}$	27.5	28.9	30.9	dB
Power Added Efficiency	PAE	42.0	47.3	—	%
Adjacent Channel Power Ratio	ACPR	—	-34.5	-30.0	dBc
$P_{out}$ @ 3 dB Compression Point, CW	P3dB	65	74	—	W
<b>Load Mismatch</b> <sup>(2)</sup> (In Freescale Doherty Production Test Fixture, 50 ohm system) $I_{DQ1A} = 24\text{ mA}$ , $I_{DQ2A} = 145\text{ mA}$ , $V_{GS1B} = 1.65\text{ Vdc}$ , $V_{GS2B} = 1.3\text{ Vdc}$ , $f = 1840\text{ MHz}$					
VSWR 10:1 at 32 Vdc, 80 W CW Output Power (3 dB Input Overdrive from 69 W CW Rated Power)	No Device Degradation				
<b>Typical Performance</b> <sup>(2)</sup> (In Freescale Doherty Characterization Test Fixture, 50 ohm system) $V_{DD} = 28\text{ Vdc}$ , $I_{DQ1A} = 24\text{ mA}$ , $I_{DQ2A} = 145\text{ mA}$ , $V_{GS1B} = 1.65\text{ Vdc}$ , $V_{GS2B} = 1.3\text{ Vdc}$ , 1805–1880 MHz Bandwidth					
$P_{out}$ @ 1 dB Compression Point, CW	P1dB	—	63	—	W
$P_{out}$ @ 3 dB Compression Point <sup>(4)</sup>	P3dB	—	74	—	W
AM/PM (Maximum value measured at the P3dB compression point across the 1805–1880 MHz frequency range.)	$\Phi$	—	-15	—	°
VBW Resonance Point (IMD Third Order Intermodulation Inflection Point)	$VBW_{res}$	—	120	—	MHz
Quiescent Current Accuracy over Temperature <sup>(5)</sup> with 2 k $\Omega$ Gate Feed Resistors (-30 to 85°C) Stage 1 with 2 k $\Omega$ Gate Feed Resistors (-30 to 85°C) Stage 2	$\Delta I_{QT}$	— —	1.0 2.0	— —	%
Gain Flatness in 75 MHz Bandwidth @ $P_{out} = 12\text{ W Avg.}$	$G_F$	—	0.3	—	dB
Gain Variation over Temperature (-30°C to +85°C)	$\Delta G$	—	0.026	—	dB/°C
Output Power Variation over Temperature (-30°C to +85°C)	$\Delta P_{1dB}$	—	0.011	—	dB/°C

**Table 6. Ordering Information**

Device	Tape and Reel Information	Package
A2I20H060NR1	R1 Suffix = 500 Units, 44 mm Tape Width, 13-inch Reel	TO-270WB-15
A2I20H060GNR1		TO-270WBG-15

- Part internally input matched.
- Measurements made with device in an asymmetrical Doherty configuration.
- Measurements made with device in straight lead configuration before any lead forming operation is applied. Lead forming is used for gull wing (GN) parts.
- P3dB =  $P_{avg} + 7.0\text{ dB}$  where  $P_{avg}$  is the average output power measured using an unclipped W-CDMA single-carrier input signal where output PAR is compressed to 7.0 dB @ 0.01% probability on CCDF.
- Refer to AN1977, *Quiescent Current Thermal Tracking Circuit in the RF Integrated Circuit Family*, and to AN1987, *Quiescent Current Control for the RF Integrated Circuit Device Family*. Go to <http://www.nxp.com/RF> and search for AN1977 or AN1987.

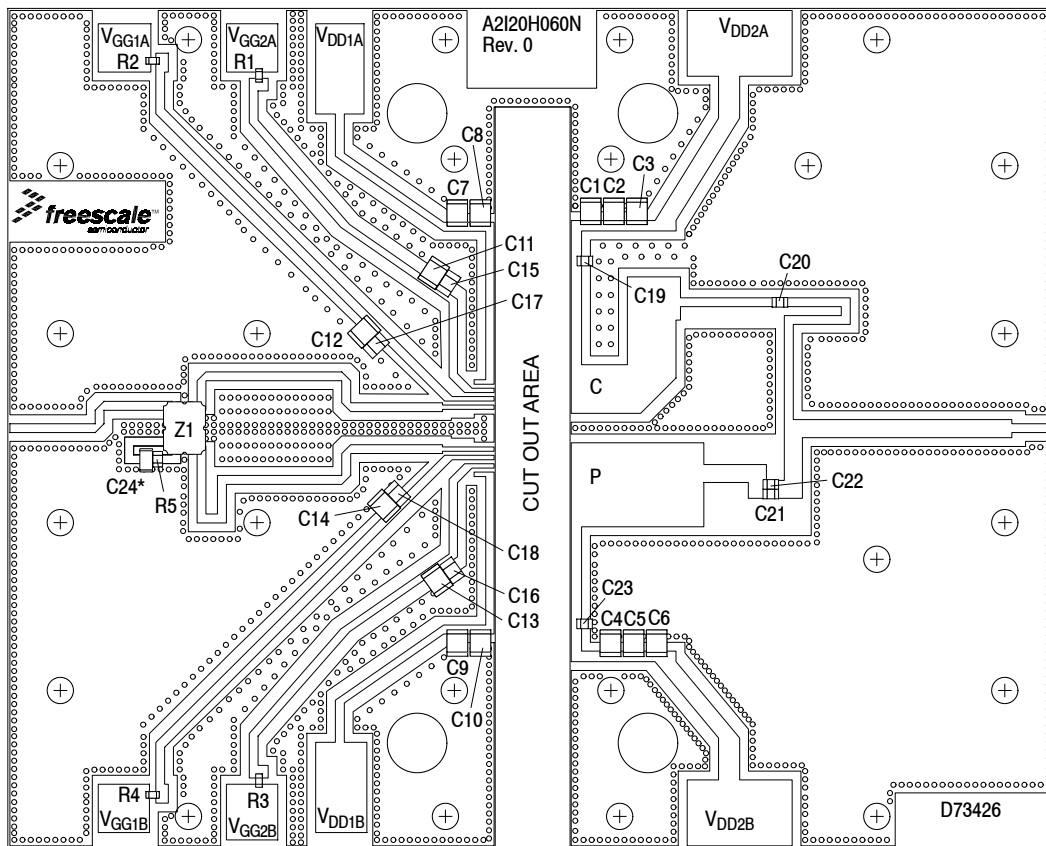

\*C24 is mounted vertically.

Figure 3. A2120H060NR1 Production Test Circuit Component Layout

Table 7. A2120H060NR1 Production Test Circuit Component Designations and Values

Part	Description	Part Number	Manufacturer
C1, C2, C3, C4, C5, C6, C7, C8, C9, C10, C11, C12, C13, C14	10 $\mu$ F Chip Capacitors	C3225X7S1H106K250AB	TDK
C15, C16, C17, C18	10 nF Chip Capacitors	08055C103KAT2A	AVX
C19, C20, C21, C22, C23	10 pF Chip Capacitors	ATC600S100JT250XT	ATC
C24	1.3 pF Chip Capacitor	ATC100B1R3BT500XT	ATC
R1, R2, R3, R4	2.2 k $\Omega$ , 1/8 W Chip Resistors	WCR0805-2K2FI	Welwyn
R5	50 $\Omega$ , 8 W Chip Resistor	C8A50Z4A	Anaren
Z1	1700–2000 MHz Band, 5 dB Directional Coupler	X3C19P1-05S	Anaren
PCB	RF35, 0.020", $\epsilon_r = 3.55$	D73426	MTL

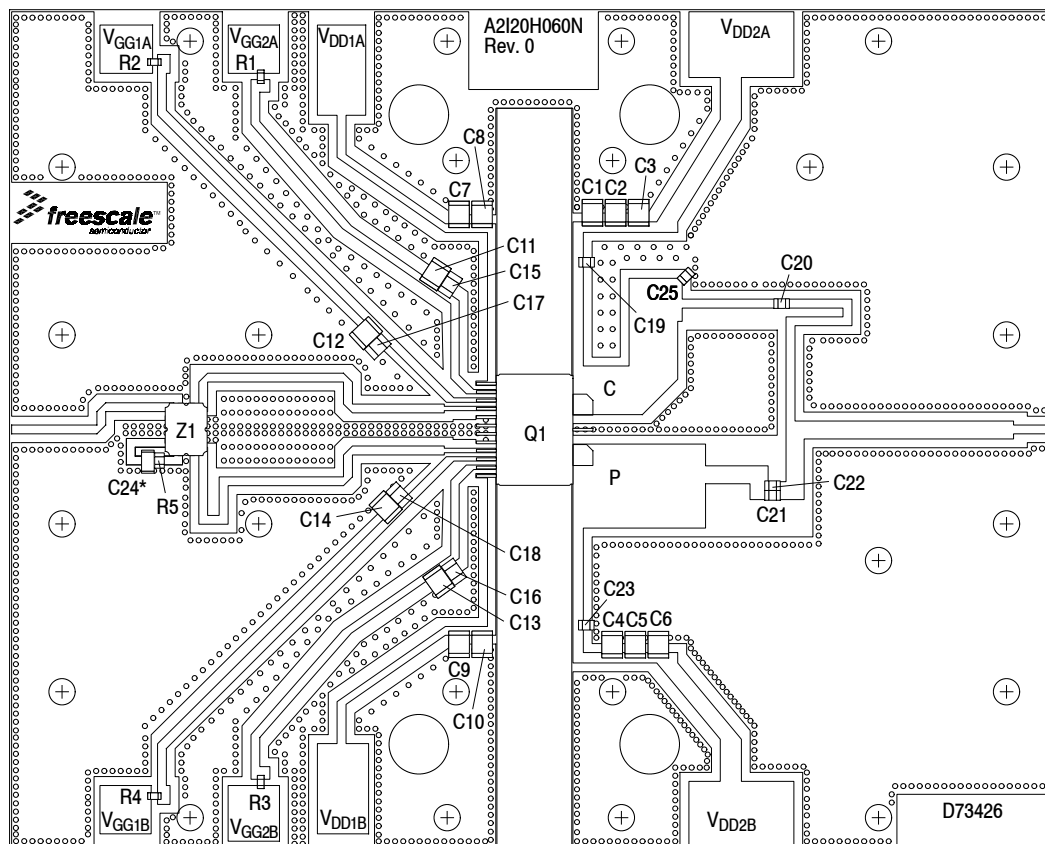

\*C24 is mounted vertically.

Note: All data measured in fixture with device soldered to heatsink.

**Figure 4. A2I20H060NR1 Characterization Test Circuit Component Layout**

**Table 8. A2I20H060NR1 Characterization Test Circuit Component Designations and Values**

Part	Description	Part Number	Manufacturer
C1, C2, C3, C4, C5, C6, C7, C8, C9, C10, C11, C12, C13, C14	10 $\mu$ F Chip Capacitors	C3225X7S1H106K250AB	TDK
C15, C16, C17, C18	10 nF Chip Capacitors	08055C103KAT2A	AVX
C19, C20, C21, C22, C23	10 pF Chip Capacitors	ATC600S100JT250XT	ATC
C24	1.3 pF Chip Capacitor	ATC100B1R3BT500XT	ATC
C25	0.3 pF Chip Capacitor	ATC600S0R3BT250XT	ATC
Q1	RF LDMOS Power Amplifier	A2I20H060NR1	Freescale
R1, R2, R3, R4	2.2 k $\Omega$ , 1/8 W Chip Resistors	WCR0805-2K2FI	Welwyn
R5	50 $\Omega$ , 8 W Chip Resistor	C8A50Z4A	Anaren
Z1	1700–2000 MHz Band, 5 dB Directional Coupler	X3C19P1-05S	Anaren
PCB	RF35, 0.020", $\epsilon_r = 3.55$	D73426	MTL

### TYPICAL CHARACTERISTICS — 1805–1880 MHz

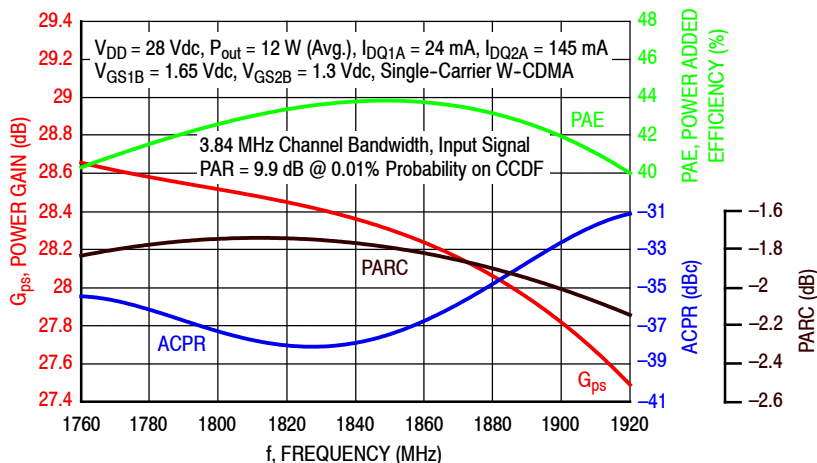

**Figure 5. Single-Carrier Output Peak-to-Average Ratio Compression (PARC) Broadband Performance @  $P_{out} = 12$  Watts Avg.**

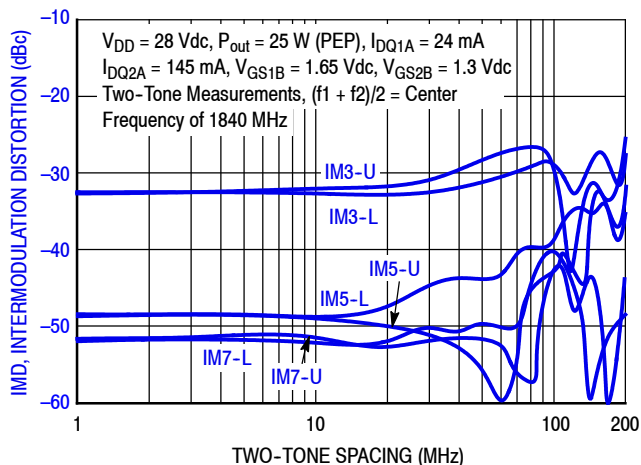

**Figure 6. Intermodulation Distortion Products versus Two-Tone Spacing**

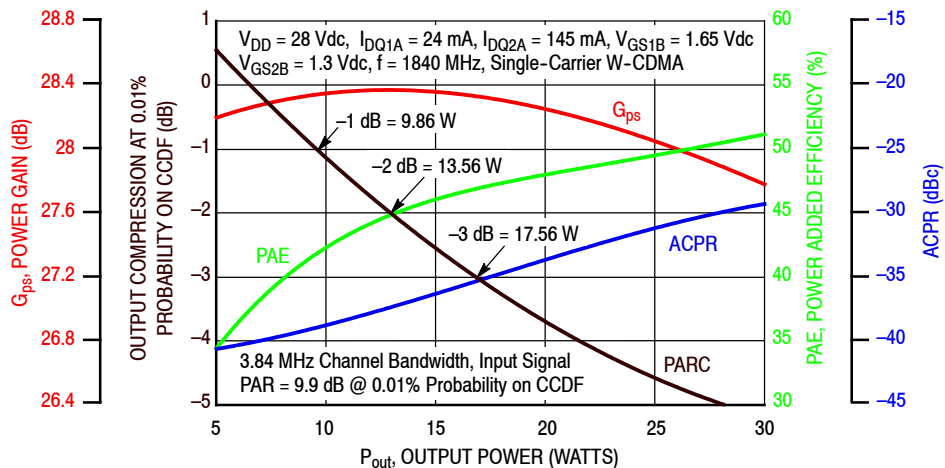

**Figure 7. Output Peak-to-Average Ratio Compression (PARC) versus Output Power**



TYPICAL CHARACTERISTICS — 1805–1880 MHz

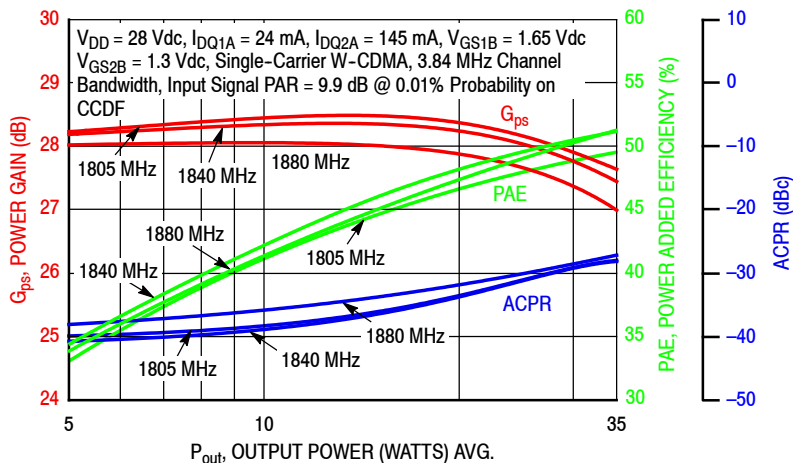

Figure 8. Single-Carrier W-CDMA Power Gain, Power Added Efficiency and ACPR versus Output Power

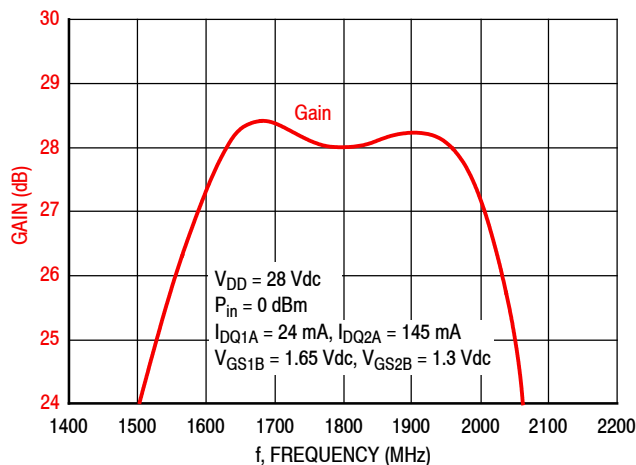

Figure 9. Broadband Frequency Response

**Table 9. Carrier Side Load Pull Performance — Maximum Power Tuning**

$V_{DD} = 28$  Vdc,  $I_{DQ1A} = 24$  mA,  $I_{DQ2A} = 149$  mA, Pulsed CW, 10  $\mu$ sec(on), 10% Duty Cycle

f (MHz)	$Z_{source}$ ( $\Omega$ )	$Z_{in}$ ( $\Omega$ )	Max Output Power					
			P1dB					
			$Z_{load}^{(1)}$ ( $\Omega$ )	Gain (dB)	(dBm)	(W)	$\eta_D$ (%)	AM/PM ( $^\circ$ )
1805	43.9 – j21.6	41.6 + j19.1	4.30 + j0.95	32.2	44.3	27	55.7	–7
1840	49.1 – j21.7	45.4 + j19.9	3.91 + j1.32	32.4	44.4	28	57.7	–7
1880	54.0 – j19.0	51.9 + j17.3	3.92 + j1.42	32.3	44.4	28	58.3	–8

f (MHz)	$Z_{source}$ ( $\Omega$ )	$Z_{in}$ ( $\Omega$ )	Max Output Power					
			P3dB					
			$Z_{load}^{(2)}$ ( $\Omega$ )	Gain (dB)	(dBm)	(W)	$\eta_D$ (%)	AM/PM ( $^\circ$ )
1805	43.9 – j21.6	43.8 + j18.4	4.55 + j0.70	30.0	45.0	32	57.1	–11
1840	49.1 – j21.7	47.9 + j18.3	4.31 + j1.06	30.2	45.1	32	58.6	–11
1880	54.0 – j19.0	53.9 + j14.6	4.31 + j1.12	30.0	45.1	32	58.4	–11

(1) Load impedance for optimum P1dB power.

(2) Load impedance for optimum P3dB power.

$Z_{source}$  = Measured impedance presented to the input of the device at the package reference plane.

$Z_{in}$  = Impedance as measured from gate contact to ground.

$Z_{load}$  = Measured impedance presented to the output of the device at the package reference plane.

**Table 10. Carrier Side Load Pull Performance — Maximum Efficiency Tuning**

$V_{DD} = 28$  Vdc,  $I_{DQ1A} = 24$  mA,  $I_{DQ2A} = 149$  mA, Pulsed CW, 10  $\mu$ sec(on), 10% Duty Cycle

f (MHz)	$Z_{source}$ ( $\Omega$ )	$Z_{in}$ ( $\Omega$ )	Max Drain Efficiency					
			P1dB					
			$Z_{load}^{(1)}$ ( $\Omega$ )	Gain (dB)	(dBm)	(W)	$\eta_D$ (%)	AM/PM ( $^\circ$ )
1805	43.9 – j21.6	41.9 + j25.2	2.87 + j4.44	33.8	41.9	16	65.5	–12
1840	49.1 – j21.7	47.7 + j27.1	2.25 + j4.50	33.9	41.6	14	69.2	–13
1880	54.0 – j19.0	55.7 + j23.0	2.35 + j4.13	33.7	42.1	16	69.0	–13

f (MHz)	$Z_{source}$ ( $\Omega$ )	$Z_{in}$ ( $\Omega$ )	Max Drain Efficiency					
			P3dB					
			$Z_{load}^{(2)}$ ( $\Omega$ )	Gain (dB)	(dBm)	(W)	$\eta_D$ (%)	AM/PM ( $^\circ$ )
1805	43.9 – j21.6	42.7 + j23.9	2.62 + j4.15	32.0	42.7	19	66.4	–17
1840	49.1 – j21.7	48.7 + j24.0	2.47 + j4.20	31.9	42.8	19	70.0	–17
1880	54.0 – j19.0	56.7 + j20.7	2.17 + j4.13	31.7	42.5	18	69.3	–19

(1) Load impedance for optimum P1dB efficiency.

(2) Load impedance for optimum P3dB efficiency.

$Z_{source}$  = Measured impedance presented to the input of the device at the package reference plane.

$Z_{in}$  = Impedance as measured from gate contact to ground.

$Z_{load}$  = Measured impedance presented to the output of the device at the package reference plane.

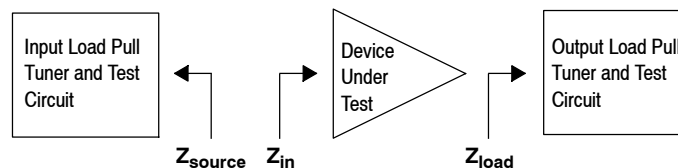

**Table 11. Peaking Side Load Pull Performance — Maximum Power Tuning** $V_{DD} = 28$  Vdc,  $I_{DQ1B} = 43$  mA,  $V_{GS2B} = 1.3$  Vdc, Pulsed CW, 10  $\mu$ sec(on), 10% Duty Cycle

f (MHz)	$Z_{source}$ ( $\Omega$ )	$Z_{in}$ ( $\Omega$ )	Max Output Power					
			P1dB					
			$Z_{load}^{(1)}$ ( $\Omega$ )	Gain (dB)	(dBm)	(W)	$\eta_D$ (%)	AM/PM ( $^\circ$ )
1805	35.1 – j7.58	36.1 + j8.10	2.33 – j0.53	28.6	46.5	45	57.5	–16
1840	33.9 – j9.77	35.8 + j8.91	2.23 – j0.44	28.6	46.6	45	58.0	–17
1880	36.6 – j10.5	37.3 + j8.43	2.22 – j0.35	28.5	46.5	45	57.0	–15

f (MHz)	$Z_{source}$ ( $\Omega$ )	$Z_{in}$ ( $\Omega$ )	Max Output Power					
			P3dB					
			$Z_{load}^{(2)}$ ( $\Omega$ )	Gain (dB)	(dBm)	(W)	$\eta_D$ (%)	AM/PM ( $^\circ$ )
1805	35.1 – j7.58	38.7 + j9.21	2.56 – j0.71	26.5	47.2	52	58.2	–21
1840	33.9 – j9.77	38.7 + j9.51	2.44 – j0.60	26.4	47.2	52	58.4	–22
1880	36.6 – j10.5	40.5 + j8.27	2.43 – j0.48	26.4	47.1	51	57.6	–20

(1) Load impedance for optimum P1dB power.

(2) Load impedance for optimum P3dB power.

 $Z_{source}$  = Measured impedance presented to the input of the device at the package reference plane. $Z_{in}$  = Impedance as measured from gate contact to ground. $Z_{load}$  = Measured impedance presented to the output of the device at the package reference plane.**Table 12. Peaking Side Load Pull Performance — Maximum Efficiency Tuning** $V_{DD} = 28$  Vdc,  $I_{DQ1B} = 43$  mA,  $V_{GS2B} = 1.3$  Vdc, Pulsed CW, 10  $\mu$ sec(on), 10% Duty Cycle

f (MHz)	$Z_{source}$ ( $\Omega$ )	$Z_{in}$ ( $\Omega$ )	Max Drain Efficiency					
			P1dB					
			$Z_{load}^{(1)}$ ( $\Omega$ )	Gain (dB)	(dBm)	(W)	$\eta_D$ (%)	AM/PM ( $^\circ$ )
1805	35.1 – j7.58	32.3 + j11.3	0.81 + j2.03	29.2	41.8	15	73.5	–56
1840	33.9 – j9.77	32.9 + j12.8	0.84 + j1.97	28.8	41.8	15	72.7	–62
1880	36.6 – j10.5	35.1 + j12.5	0.96 + j1.83	28.9	42.4	17	70.3	–67

f (MHz)	$Z_{source}$ ( $\Omega$ )	$Z_{in}$ ( $\Omega$ )	Max Drain Efficiency					
			P3dB					
			$Z_{load}^{(2)}$ ( $\Omega$ )	Gain (dB)	(dBm)	(W)	$\eta_D$ (%)	AM/PM ( $^\circ$ )
1805	35.1 – j7.58	34.1 + j11.5	0.83 + j1.85	27.4	42.7	19	72.9	–49
1840	33.9 – j9.77	34.8 + j12.0	1.07 + j1.56	27.5	43.8	24	71.8	–53
1880	36.6 – j10.5	37.7 + j10.8	1.45 + j1.41	27.4	44.9	31	69.5	–32

(1) Load impedance for optimum P1dB efficiency.

(2) Load impedance for optimum P3dB efficiency.

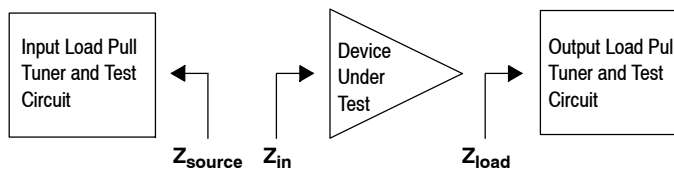
 $Z_{source}$  = Measured impedance presented to the input of the device at the package reference plane. $Z_{in}$  = Impedance as measured from gate contact to ground. $Z_{load}$  = Measured impedance presented to the output of the device at the package reference plane.

**P1dB – TYPICAL CARRIER LOAD PULL CONTOURS — 1840 MHz**

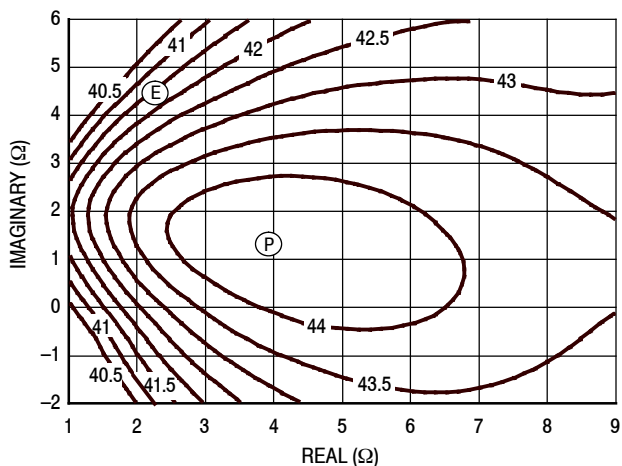

**Figure 10. P1dB Load Pull Output Power Contours (dBm)**

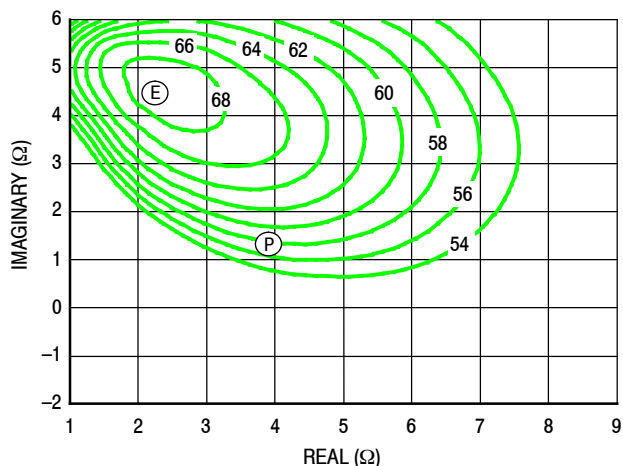

**Figure 11. P1dB Load Pull Efficiency Contours (%)**

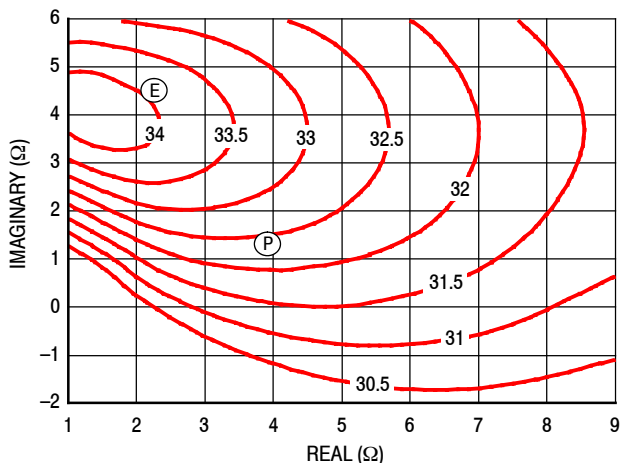

**Figure 12. P1dB Load Pull Gain Contours (dB)**

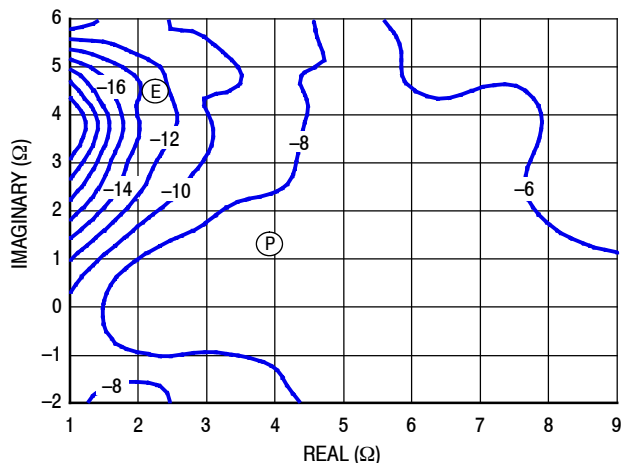

**Figure 13. P1dB Load Pull AM/PM Contours (°)**

**NOTE:** (P) = Maximum Output Power  
 (E) = Maximum Drain Efficiency

- Gain
- Drain Efficiency
- Linearity
- Output Power

P3dB – TYPICAL CARRIER LOAD PULL CONTOURS — 1840 MHz

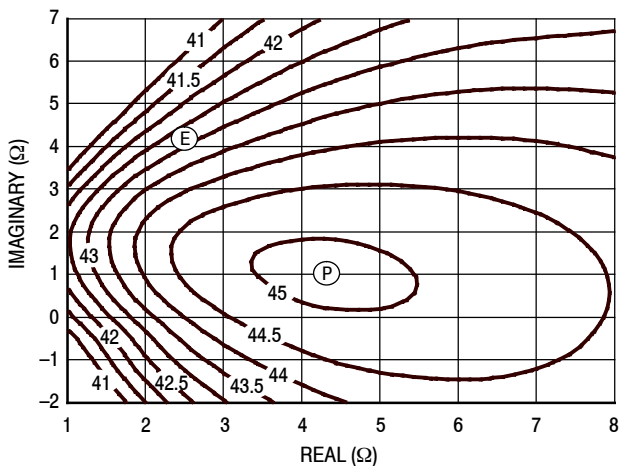

Figure 14. P3dB Load Pull Output Power Contours (dBm)

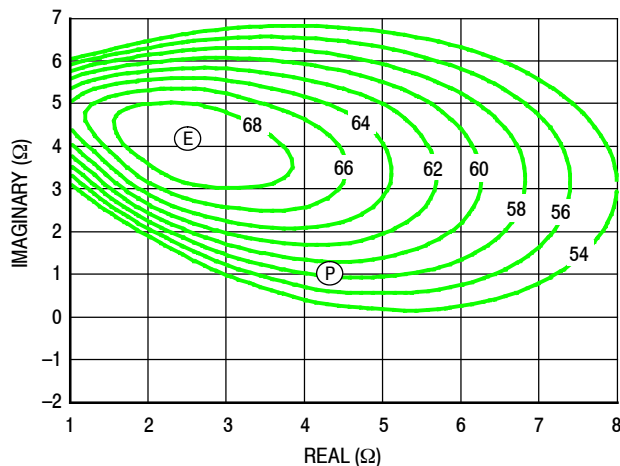

Figure 15. P3dB Load Pull Efficiency Contours (%)

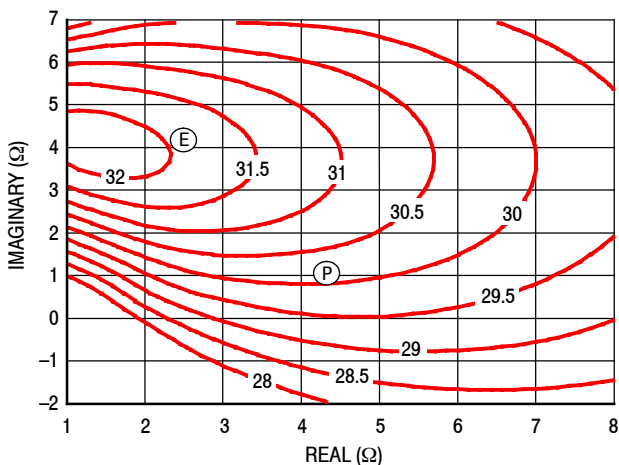

Figure 16. P3dB Load Pull Gain Contours (dB)

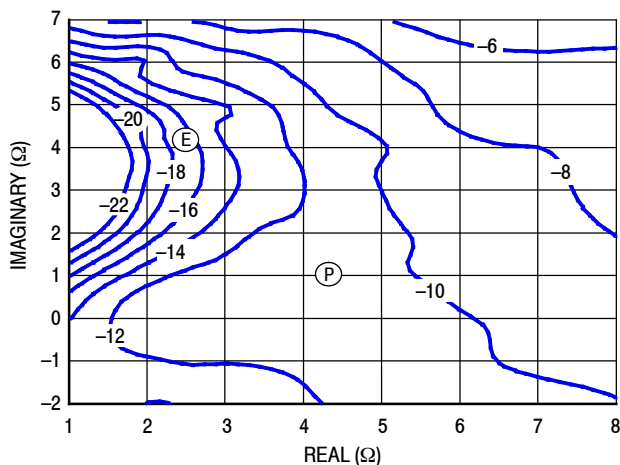

Figure 17. P3dB Load Pull AM/PM Contours (°)

NOTE: (P) = Maximum Output Power  
(E) = Maximum Drain Efficiency

- Gain
- Drain Efficiency
- Linearity
- Output Power

## P1dB – TYPICAL PEAKING LOAD PULL CONTOURS — 1840 MHz

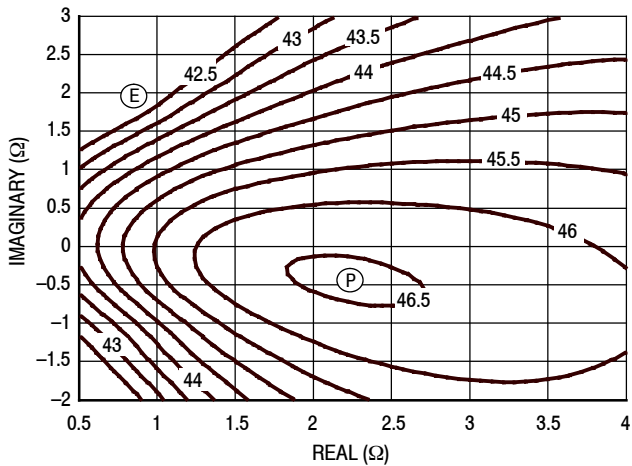

Figure 18. P1dB Load Pull Output Power Contours (dBm)

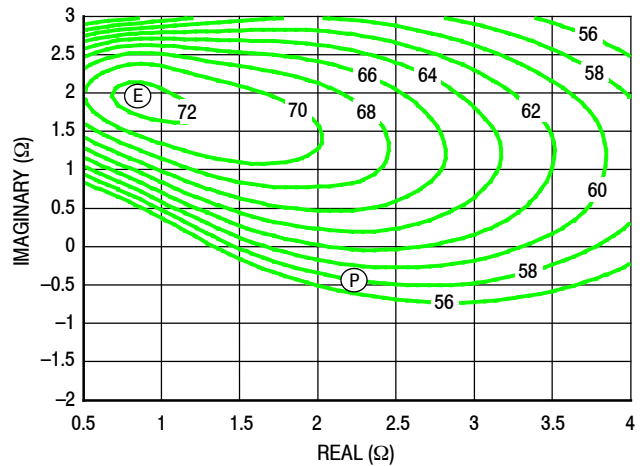

Figure 19. P1dB Load Pull Efficiency Contours (%)

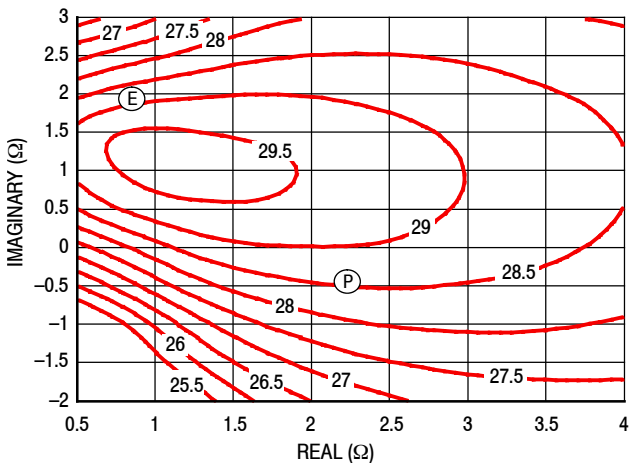

Figure 20. P1dB Load Pull Gain Contours (dB)

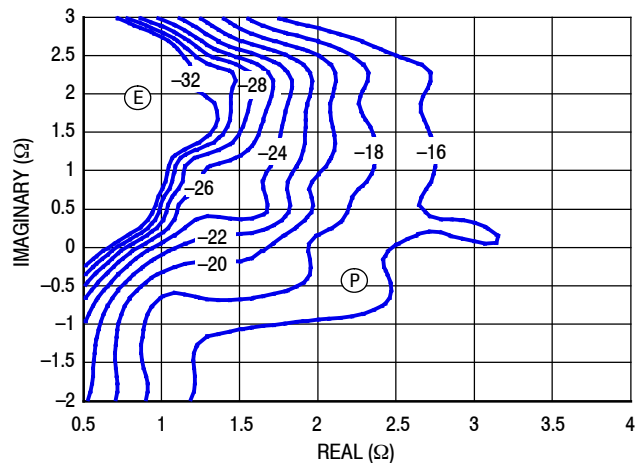
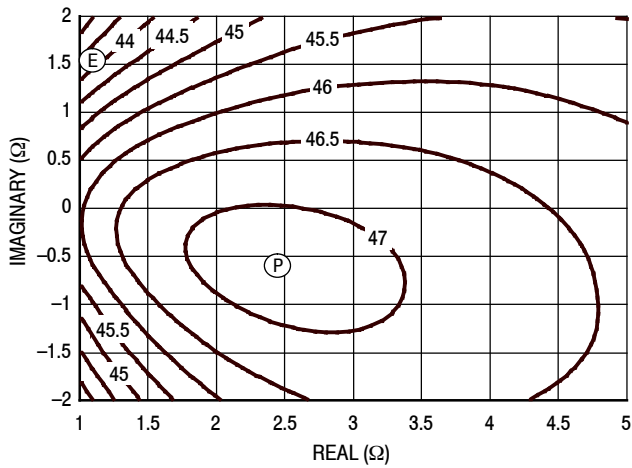

Figure 21. P1dB Load Pull AM/PM Contours (°)

**NOTE:** (P) = Maximum Output Power  
(E) = Maximum Drain Efficiency

- Gain
- Drain Efficiency
- Linearity
- Output Power

**P3dB – TYPICAL PEAKING LOAD PULL CONTOURS — 1840 MHz**



**Figure 22. P3dB Load Pull Output Power Contours (dBm)**

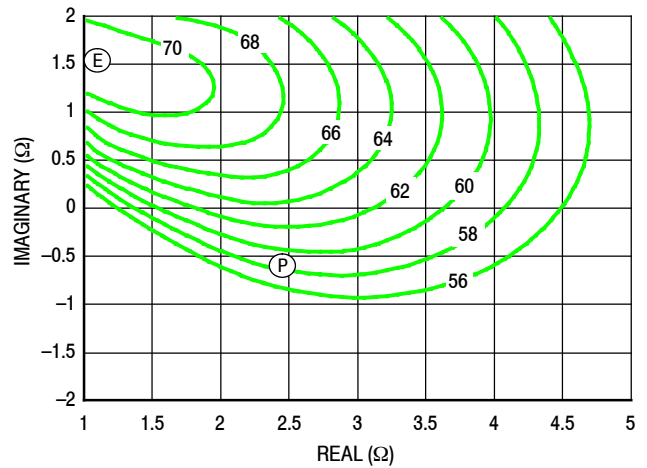

**Figure 23. P3dB Load Pull Efficiency Contours (%)**

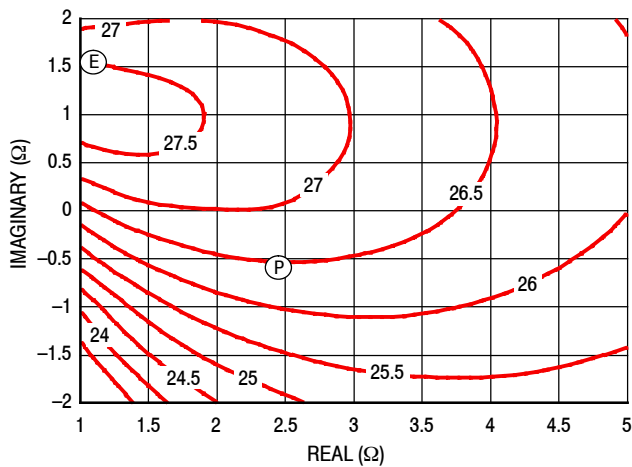

**Figure 24. P3dB Load Pull Gain Contours (dB)**

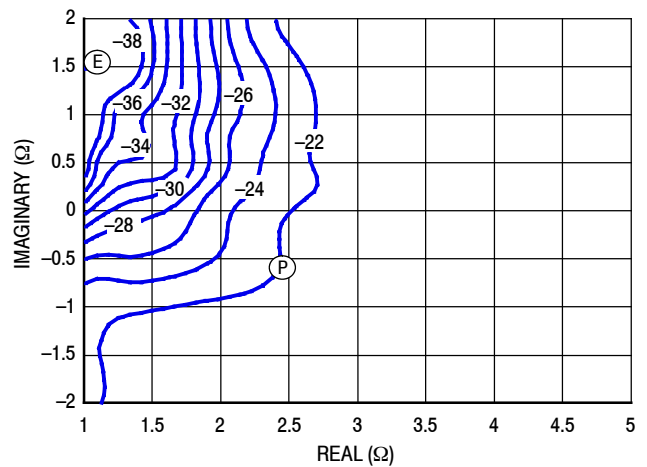
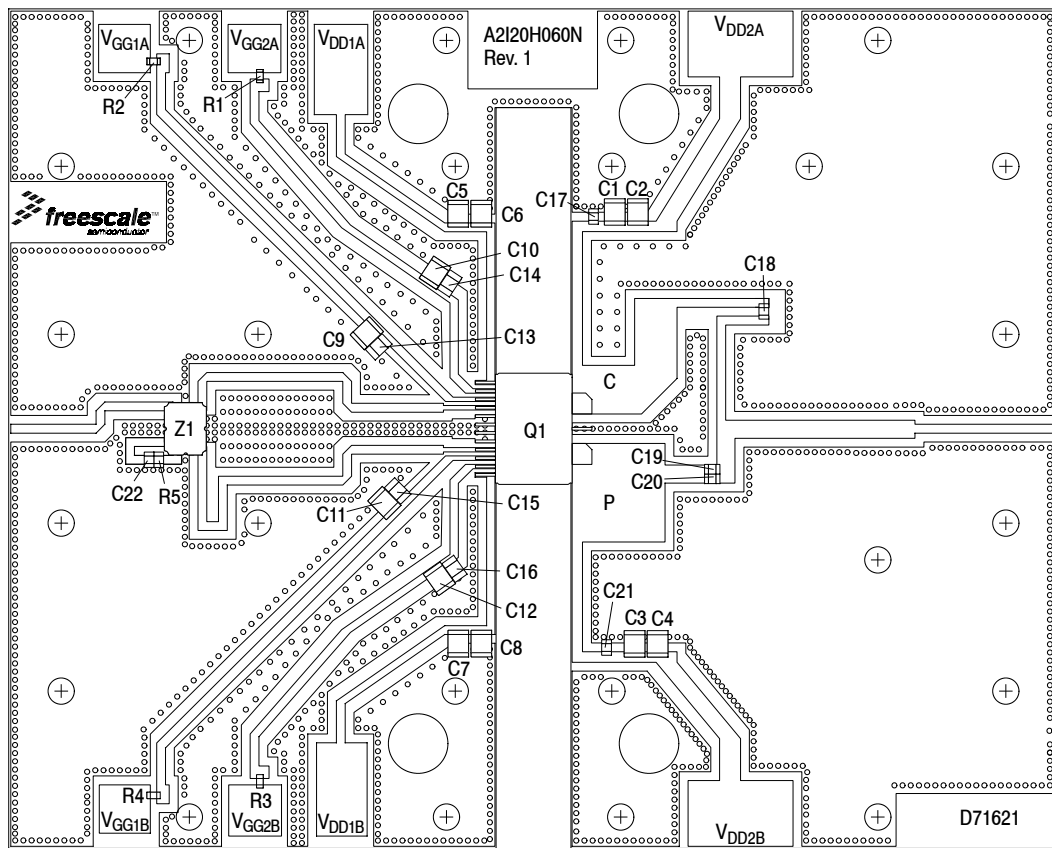

**Figure 25. P3dB Load Pull AM/PM Contours (°)**

**NOTE:** (P) = Maximum Output Power

(E) = Maximum Drain Efficiency

- Gain
- Drain Efficiency
- Linearity
- Output Power



Note: All data measured in fixture with device soldered to heatsink.

Figure 26. A2120H060NR1 Test Circuit Component Layout — 2110–2170 MHz

Table 13. A2120H060NR1 Test Circuit Component Designations and Values — 2110–2170 MHz

Part	Description	Part Number	Manufacturer
C1, C2, C3, C4, C5, C6, C7, C8, C9, C10, C11, C12	10 $\mu$ F Chip Capacitors	C3225X7S1H106K250AB	TDK
C13, C14, C15, C16	10 nF Chip Capacitors	08055C103KAT2A	AVX
C17, C18, C19, C20, C21	10 pF Chip Capacitors	ATC600S100JT250XT	ATC
C22	0.7 pF Chip Capacitor	ATC600S0R7BT250XT	ATC
Q1	RF LDMOS Power Amplifier	A2120H060NR1	Freescale
R1, R2, R3, R4	2.2 k $\Omega$ , 1/8 W Chip Resistors	WCR0805-2K2FI	Welwyn
R5	50 $\Omega$ , 8 W Chip Resistor	C8A50Z4A	Anaren
Z1	2000–2300 MHz Band, 5 dB Directional Coupler	X3C21P1-05S	Anaren
PCB	RF35, 0.020", $\epsilon_r = 3.55$	D71621	MTL



### TYPICAL CHARACTERISTICS — 2110–2170 MHz

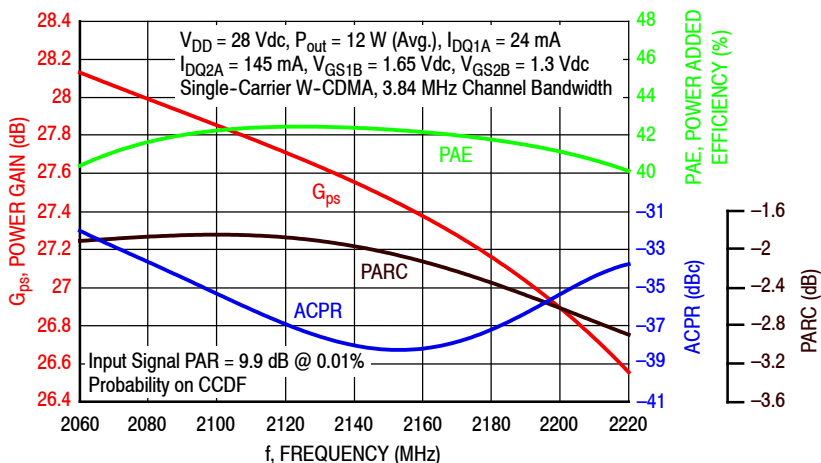

Figure 27. Single-Carrier Output Peak-to-Average Ratio Compression (PARC) Broadband Performance @  $P_{out} = 12$  Watts Avg.

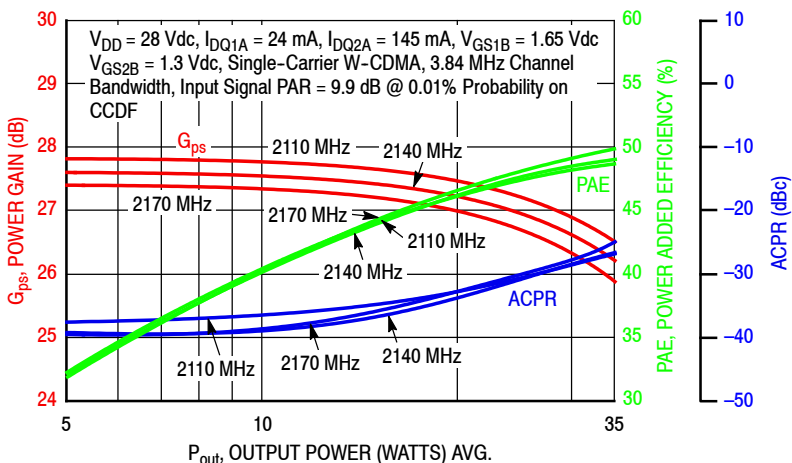

Figure 28. Single-Carrier W-CDMA Power Gain, Power Added Efficiency and ACPR versus Output Power

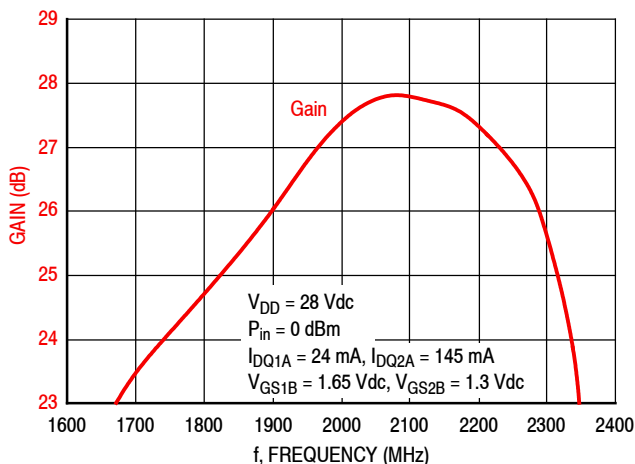

Figure 29. Broadband Frequency Response

**Table 14. Carrier Side Load Pull Performance — Maximum Power Tuning**

$V_{DD} = 28$  Vdc,  $I_{DQ1A} = 24$  mA,  $I_{DQ2A} = 149$  mA, Pulsed CW, 10  $\mu$ sec(on), 10% Duty Cycle

f (MHz)	$Z_{source}$ ( $\Omega$ )	$Z_{in}$ ( $\Omega$ )	Max Output Power					
			P1dB					
			$Z_{load}^{(1)}$ ( $\Omega$ )	Gain (dB)	(dBm)	(W)	$\eta_D$ (%)	AM/PM ( $^\circ$ )
2110	69.5 + j18.1	70.6 – j18.1	3.84 + j1.66	31.7	44.1	26	53.2	–8
2140	65.9 + j18.2	69.2 – j19.8	4.08 + j1.52	31.6	44.2	26	53.8	–8
2170	69.5 + j20.2	69.1 – j20.1	3.94 + j1.55	31.7	44.2	27	55.3	–9

f (MHz)	$Z_{source}$ ( $\Omega$ )	$Z_{in}$ ( $\Omega$ )	Max Output Power					
			P3dB					
			$Z_{load}^{(2)}$ ( $\Omega$ )	Gain (dB)	(dBm)	(W)	$\eta_D$ (%)	AM/PM ( $^\circ$ )
2110	69.5 + j18.1	67.0 – j19.9	4.38 + j1.42	29.5	44.8	30	53.4	–12
2140	65.9 + j18.2	65.6 – j21.2	4.45 + j1.31	29.4	44.9	31	54.2	–11
2170	69.5 + j20.2	65.5 – j20.8	4.24 + j1.26	29.5	44.9	31	55.2	–12

(1) Load impedance for optimum P1dB power.

(2) Load impedance for optimum P3dB power.

$Z_{source}$  = Measured impedance presented to the input of the device at the package reference plane.

$Z_{in}$  = Impedance as measured from gate contact to ground.

$Z_{load}$  = Measured impedance presented to the output of the device at the package reference plane.

**Table 15. Carrier Side Load Pull Performance — Maximum Efficiency Tuning**

$V_{DD} = 28$  Vdc,  $I_{DQ1A} = 24$  mA,  $I_{DQ2A} = 149$  mA, Pulsed CW, 10  $\mu$ sec(on), 10% Duty Cycle

f (MHz)	$Z_{source}$ ( $\Omega$ )	$Z_{in}$ ( $\Omega$ )	Max Drain Efficiency					
			P1dB					
			$Z_{load}^{(1)}$ ( $\Omega$ )	Gain (dB)	(dBm)	(W)	$\eta_D$ (%)	AM/PM ( $^\circ$ )
2110	69.5 + j18.1	74.2 – j19.6	2.36 + j3.84	32.7	42.3	17	61.2	–12
2140	65.9 + j18.2	73.0 – j21.6	2.42 + j3.87	32.6	42.3	17	62.1	–11
2170	69.5 + j20.2	72.4 – j21.5	2.60 + j3.58	32.6	42.8	19	63.2	–11

f (MHz)	$Z_{source}$ ( $\Omega$ )	$Z_{in}$ ( $\Omega$ )	Max Drain Efficiency					
			P3dB					
			$Z_{load}^{(2)}$ ( $\Omega$ )	Gain (dB)	(dBm)	(W)	$\eta_D$ (%)	AM/PM ( $^\circ$ )
2110	69.5 + j18.1	70.8 – j20.0	2.62 + j3.53	30.7	43.5	22	60.9	–15
2140	65.9 + j18.2	69.3 – j21.7	2.66 + j3.46	30.6	43.5	23	61.8	–15
2170	69.5 + j20.2	69.5 – j21.7	2.48 + j3.34	30.6	43.5	22	63.0	–16

(1) Load impedance for optimum P1dB efficiency.

(2) Load impedance for optimum P3dB efficiency.

$Z_{source}$  = Measured impedance presented to the input of the device at the package reference plane.

$Z_{in}$  = Impedance as measured from gate contact to ground.

$Z_{load}$  = Measured impedance presented to the output of the device at the package reference plane.

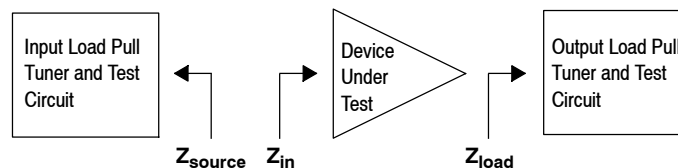

**Table 16. Peaking Side Load Pull Performance — Maximum Power Tuning** $V_{DD} = 28$  Vdc,  $I_{DQ1B} = 43$  mA,  $V_{GS2B} = 1.3$  Vdc, Pulsed CW, 10  $\mu$ sec(on), 10% Duty Cycle

f (MHz)	$Z_{source}$ ( $\Omega$ )	$Z_{in}$ ( $\Omega$ )	Max Output Power					
			P1dB					
			$Z_{load}^{(1)}$ ( $\Omega$ )	Gain (dB)	(dBm)	(W)	$\eta_D$ (%)	AM/PM ( $^\circ$ )
2110	63.5 + j9.31	67.9 – j12.2	2.29 + j0.28	27.7	46.3	43	54.8	–15
2140	68.4 + j14.6	70.3 – j18.9	2.35 + j0.19	27.6	46.3	43	54.0	–15
2170	73.3 + j22.8	72.1 – j25.6	2.32 + j0.09	27.6	46.3	43	54.0	–16

f (MHz)	$Z_{source}$ ( $\Omega$ )	$Z_{in}$ ( $\Omega$ )	Max Output Power					
			P3dB					
			$Z_{load}^{(2)}$ ( $\Omega$ )	Gain (dB)	(dBm)	(W)	$\eta_D$ (%)	AM/PM ( $^\circ$ )
2110	63.5 + j9.31	67.3 – j18.4	2.42 + j0.19	25.6	46.9	49	55.2	–19
2140	68.4 + j14.6	68.2 – j25.0	2.50 + j0.10	25.6	46.8	48	54.3	–19
2170	73.3 + j22.8	68.6 – j31.3	2.55 – j0.04	25.5	46.8	48	53.9	–21

(1) Load impedance for optimum P1dB power.

(2) Load impedance for optimum P3dB power.

 $Z_{source}$  = Measured impedance presented to the input of the device at the package reference plane. $Z_{in}$  = Impedance as measured from gate contact to ground. $Z_{load}$  = Measured impedance presented to the output of the device at the package reference plane.**Table 17. Peaking Side Load Pull Performance — Maximum Efficiency Tuning** $V_{DD} = 28$  Vdc,  $I_{DQ1B} = 43$  mA,  $V_{GS2B} = 1.3$  Vdc, Pulsed CW, 10  $\mu$ sec(on), 10% Duty Cycle

f (MHz)	$Z_{source}$ ( $\Omega$ )	$Z_{in}$ ( $\Omega$ )	Max Drain Efficiency					
			P1dB					
			$Z_{load}^{(1)}$ ( $\Omega$ )	Gain (dB)	(dBm)	(W)	$\eta_D$ (%)	AM/PM ( $^\circ$ )
2110	63.5 + j9.31	71.0 – j8.08	1.53 + j1.79	28.3	44.6	29	64.0	–20
2140	68.4 + j14.6	74.6 – j15.1	1.51 + j1.73	28.2	44.5	28	63.3	–21
2170	73.3 + j22.8	76.8 – j23.1	1.67 + j1.62	28.2	44.8	30	62.8	–22

f (MHz)	$Z_{source}$ ( $\Omega$ )	$Z_{in}$ ( $\Omega$ )	Max Drain Efficiency					
			P3dB					
			$Z_{load}^{(2)}$ ( $\Omega$ )	Gain (dB)	(dBm)	(W)	$\eta_D$ (%)	AM/PM ( $^\circ$ )
2110	63.5 + j9.31	70.4 – j13.3	1.61 + j1.61	26.4	45.5	35	63.1	–26
2140	68.4 + j14.6	72.6 – j20.3	1.57 + j1.51	26.3	45.5	35	62.4	–26
2170	73.3 + j22.8	74.0 – j27.8	1.67 + j1.49	26.3	45.4	35	61.9	–28

(1) Load impedance for optimum P1dB efficiency.

(2) Load impedance for optimum P3dB efficiency.

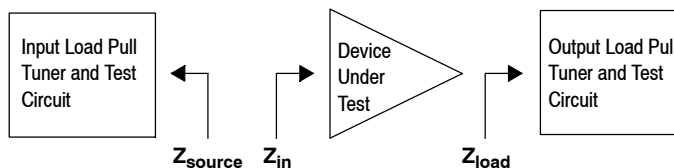
 $Z_{source}$  = Measured impedance presented to the input of the device at the package reference plane. $Z_{in}$  = Impedance as measured from gate contact to ground. $Z_{load}$  = Measured impedance presented to the output of the device at the package reference plane.

## P1dB – TYPICAL CARRIER SIDE LOAD PULL CONTOURS — 2140 MHz

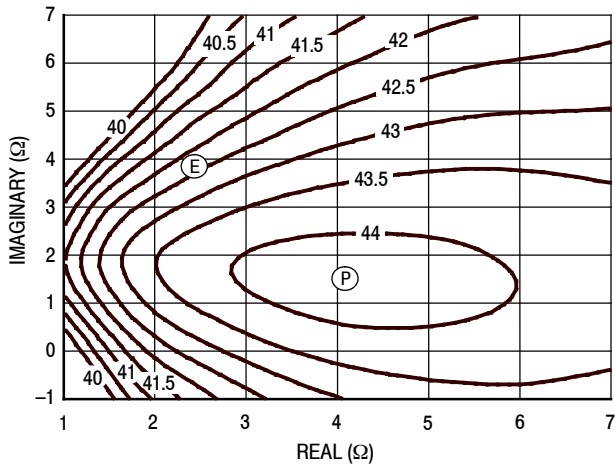

Figure 30. P1dB Load Pull Output Power Contours (dBm)

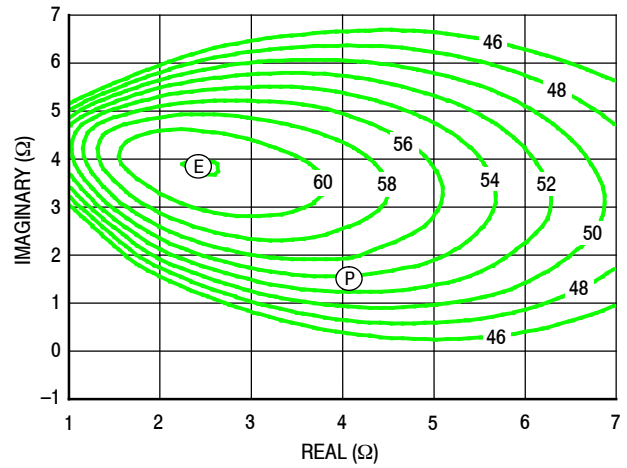

Figure 31. P1dB Load Pull Efficiency Contours (%)

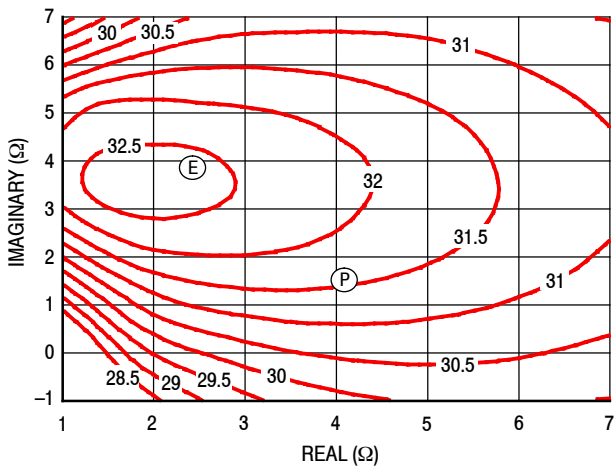

Figure 32. P1dB Load Pull Gain Contours (dB)

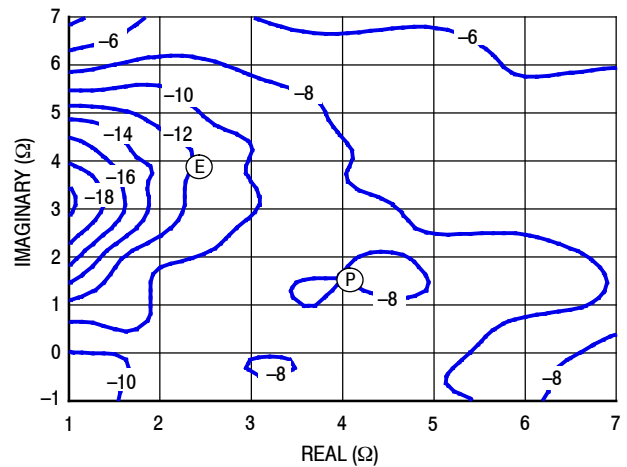

Figure 33. P1dB Load Pull AM/PM Contours (°)

**NOTE:** (P) = Maximum Output Power  
(E) = Maximum Drain Efficiency

- Gain
- Drain Efficiency
- Linearity
- Output Power

### P3dB – TYPICAL CARRIER LOAD PULL CONTOURS — 2140 MHz

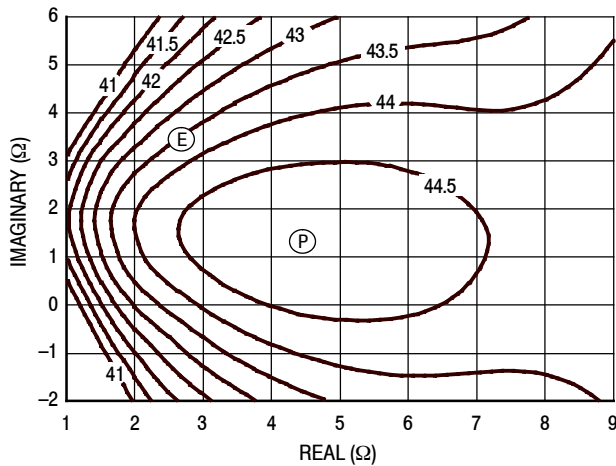

Figure 34. P3dB Load Pull Output Power Contours (dBm)

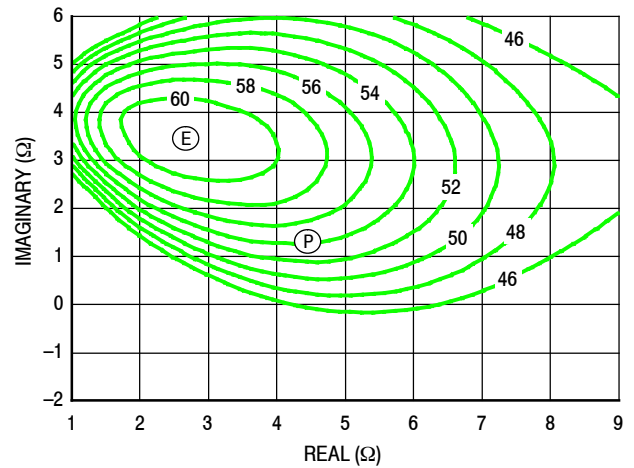

Figure 35. P3dB Load Pull Efficiency Contours (%)

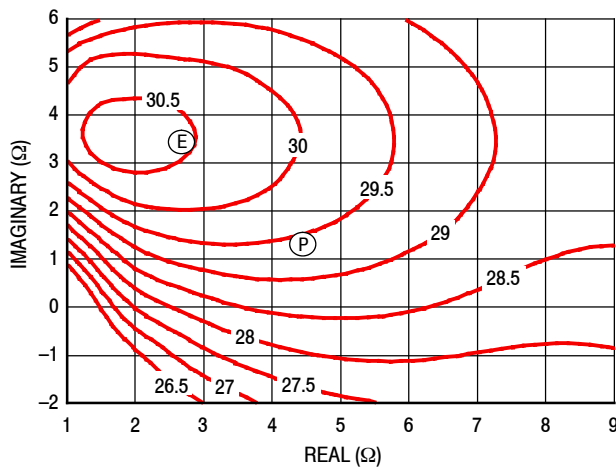

Figure 36. P3dB Load Pull Gain Contours (dB)

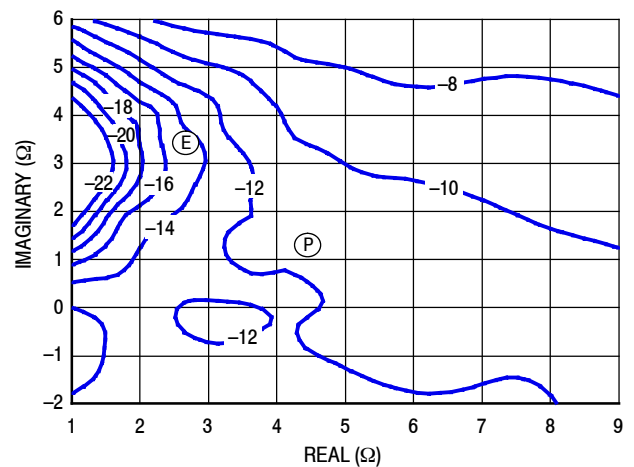
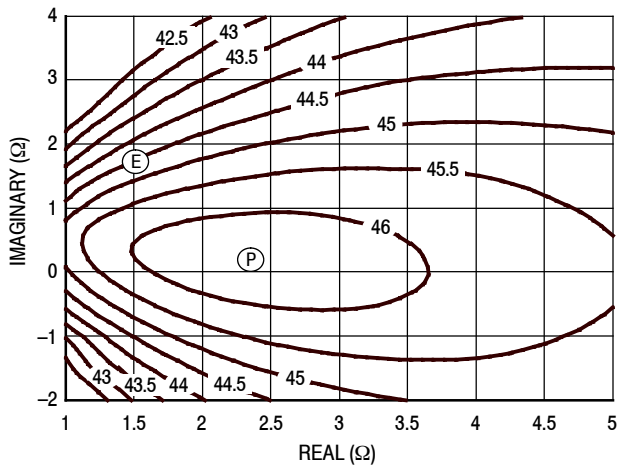

Figure 37. P3dB Load Pull AM/PM Contours (°)

**NOTE:** (P) = Maximum Output Power  
(E) = Maximum Drain Efficiency

- Gain
- Drain Efficiency
- Linearity
- Output Power

**P1dB – TYPICAL PEAKING LOAD PULL CONTOURS — 2140 MHz**



**Figure 38. P1dB Load Pull Output Power Contours (dBm)**

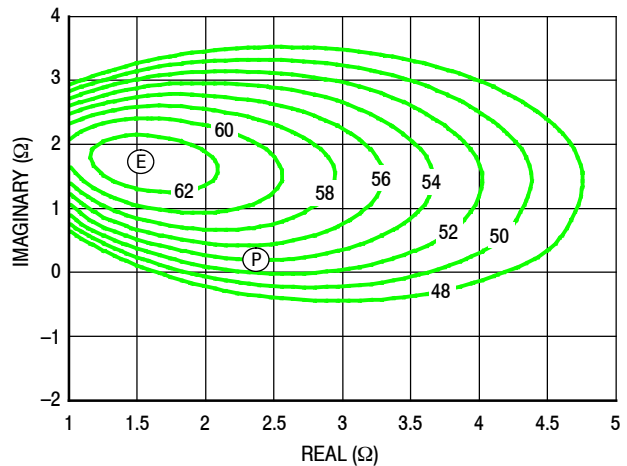

**Figure 39. P1dB Load Pull Efficiency Contours (%)**

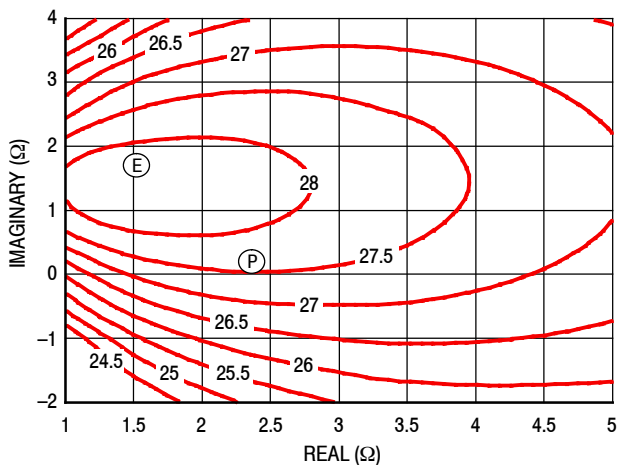

**Figure 40. P1dB Load Pull Gain Contours (dB)**

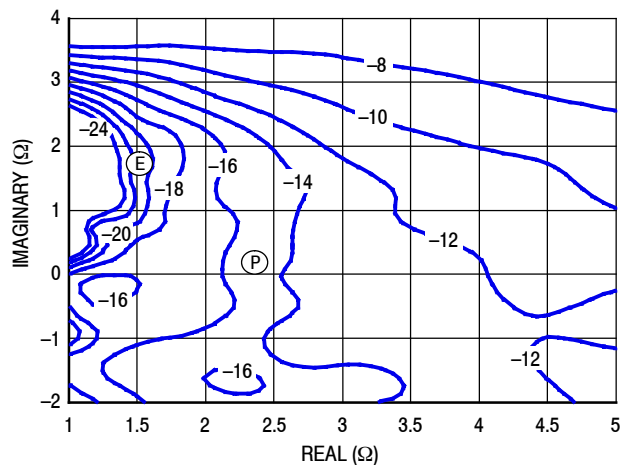
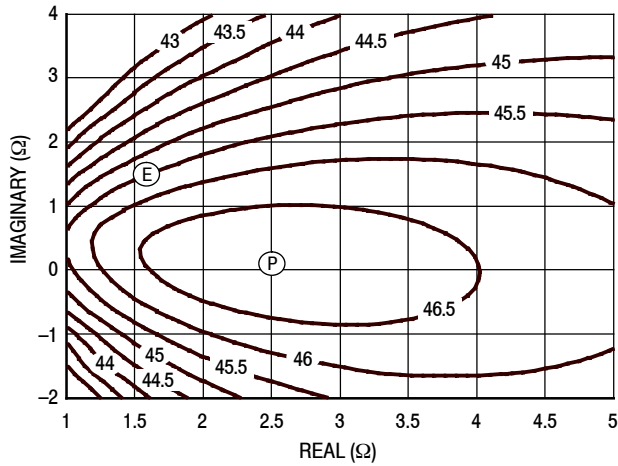

**Figure 41. P1dB Load Pull AM/PM Contours (°)**

**NOTE:** (P) = Maximum Output Power  
 (E) = Maximum Drain Efficiency

- Gain
- Drain Efficiency
- Linearity
- Output Power

**P3dB – TYPICAL PEAKING LOAD PULL CONTOURS — 2140 MHz**



**Figure 42. P3dB Load Pull Output Power Contours (dBm)**

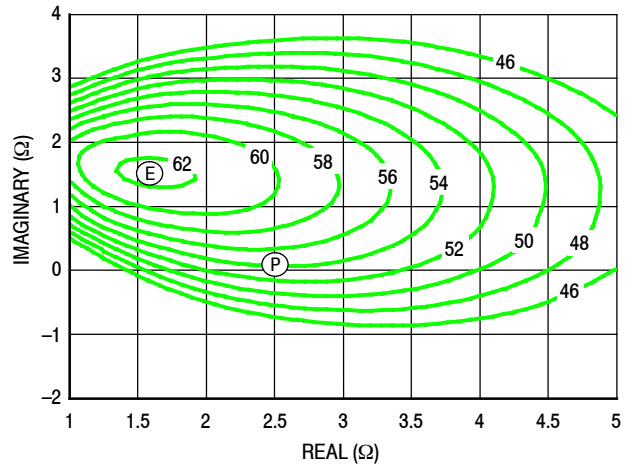

**Figure 43. P3dB Load Pull Efficiency Contours (%)**

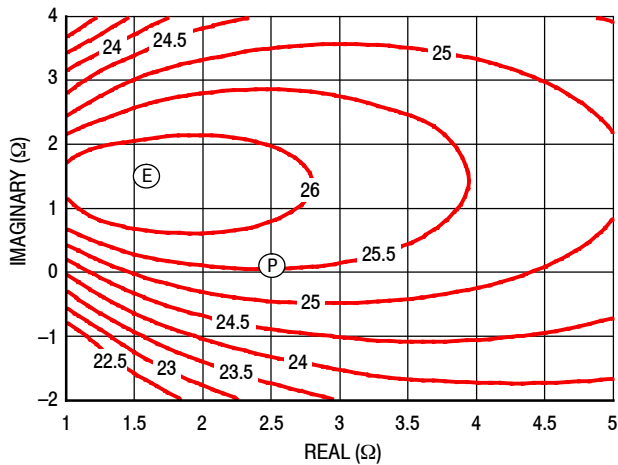

**Figure 44. P3dB Load Pull Gain Contours (dB)**

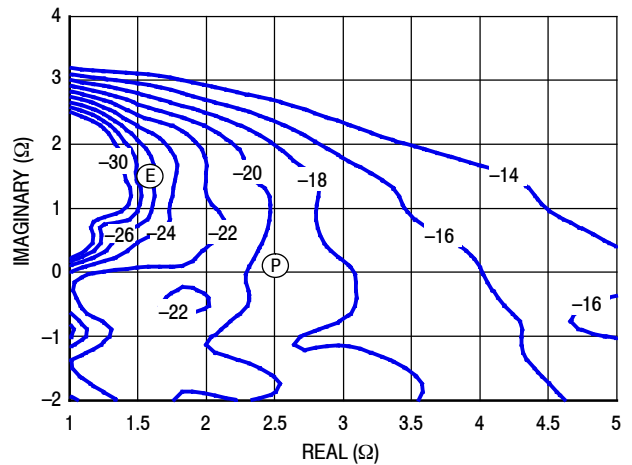
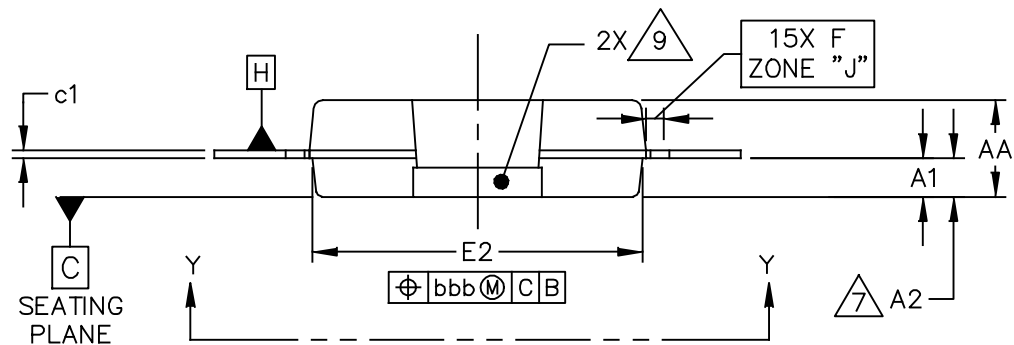
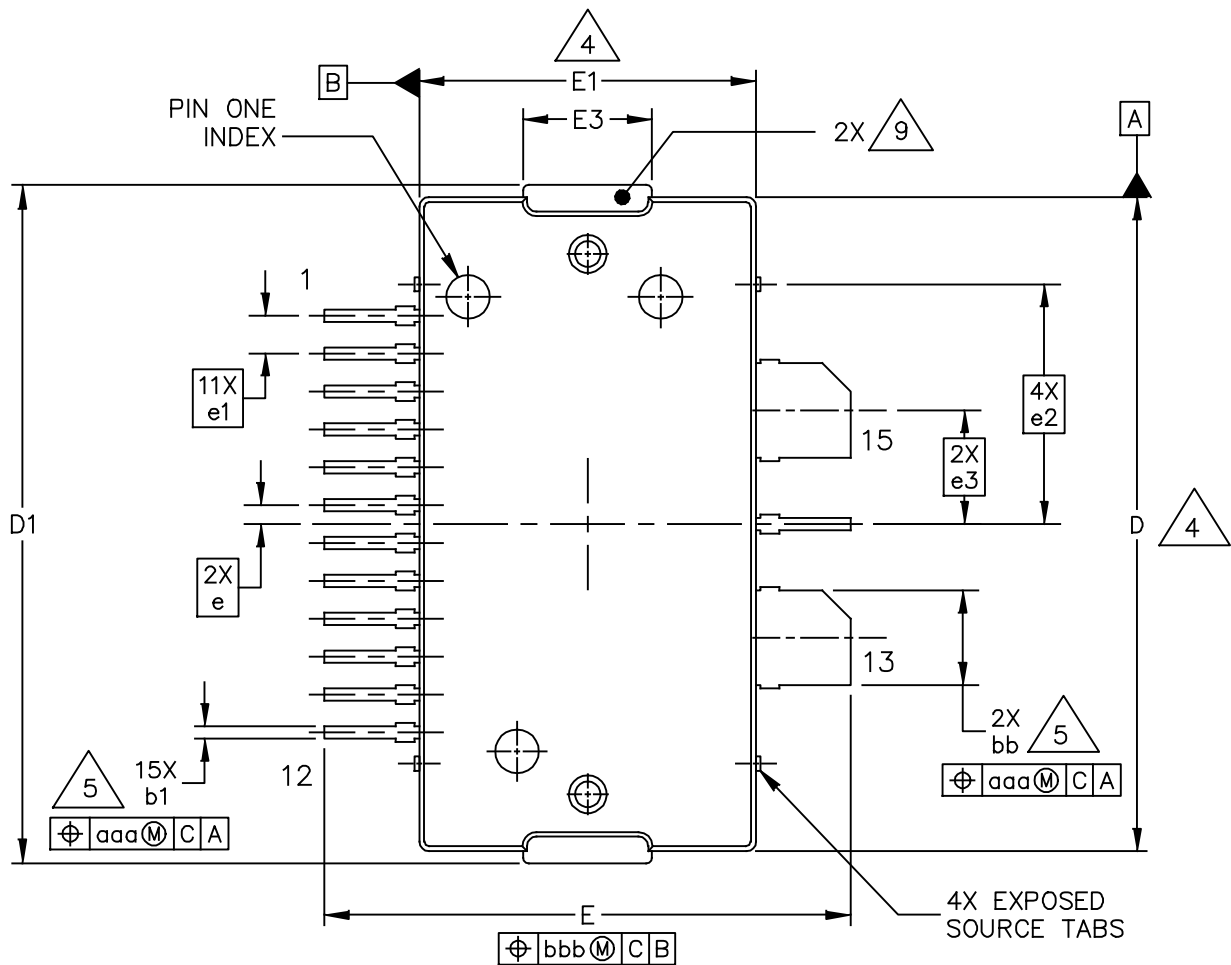

**Figure 45. P3dB Load Pull AM/PM Contours (°)**

**NOTE:** (P) = Maximum Output Power  
(E) = Maximum Drain Efficiency

- Gain
- Drain Efficiency
- Linearity
- Output Power

# PACKAGE DIMENSIONS



© FREESCALE SEMICONDUCTOR, INC. ALL RIGHTS RESERVED.	MECHANICAL OUTLINE	PRINT VERSION NOT TO SCALE
TITLE:  TO-270WB-15	DOCUMENT NO: 98ASA00630D	REV: 0
	STANDARD: NON-JEDEC	
	17 JUN 2014	



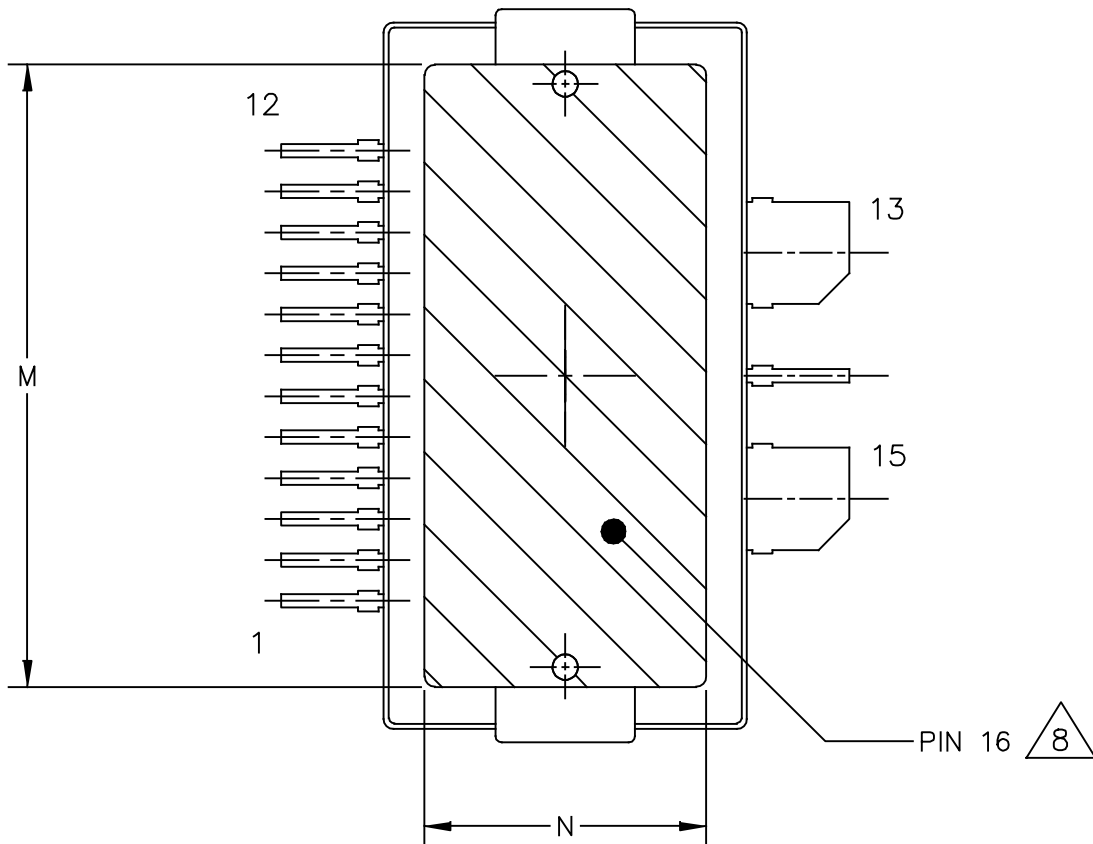

VIEW Y-Y

© FREESCALE SEMICONDUCTOR, INC. ALL RIGHTS RESERVED.	MECHANICAL OUTLINE	PRINT VERSION NOT TO SCALE	
TITLE:  TO-270WB-15		DOCUMENT NO: 98ASA00630D	REV: 0
		STANDARD: NON-JEDEC	
		17 JUN 2014	

NOTES:

1. CONTROLLING DIMENSION: INCH
2. INTERPRET DIMENSIONS AND TOLERANCES PER ASME Y14.5M-1994.
3. DATUM PLANE H IS LOCATED AT THE TOP OF LEAD AND IS COINCIDENT WITH THE LEAD WHERE THE LEAD EXITS THE PLASTIC BODY AT THE TOP OF THE PARTING LINE.
4. DIMENSIONS D AND E1 DO NOT INCLUDE MOLD PROTRUSION. ALLOWABLE PROTRUSION IS .006 INCH (0.15 MM) PER SIDE. DIMENSIONS D AND E1 DO INCLUDE MOLD MISMATCH AND ARE DETERMINED AT DATUM PLANE H.
5. DIMENSIONS bb AND b1 DO NOT INCLUDE DAMBAR PROTRUSION. ALLOWABLE DAMBAR PROTRUSION SHALL BE .005 INCH (0.13 MM) TOTAL IN EXCESS OF THE bb AND b1 DIMENSIONS AT MAXIMUM MATERIAL CONDITION.
6. DATUMS A AND B TO BE DETERMINED AT DATUM PLANE H.
7. DIMENSION A2 APPLIES WITHIN ZONE J ONLY.
8. HATCHING REPRESENTS THE EXPOSED AND SOLDERABLE AREA OF THE HEAT SLUG. DIMENSIONS M AND N REPRESENT THE VALUES BETWEEN THE TWO OPPOSITE POINTS ALONG THE EDGES OF EXPOSED AREA OF THE HEAT SLUG.
9. THESE SURFACES OF THE HEAT SLUG ARE NOT PART OF THE SOLDERABLE SURFACES AND MAY REMAIN UNPLATED.

DIM	INCH		MILLIMETER		DIM	INCH		MILLIMETER	
	MIN	MAX	MIN	MAX		MIN	MAX	MIN	MAX
AA	.099	.105	2.51	2.67	M	.600	----	15.24	----
A1	.039	.043	0.99	1.09	N	.270	----	6.86	----
A2	.040	.042	1.02	1.07	bb	.097	.103	2.46	2.62
D	.688	.692	17.48	17.58	b1	.010	.016	0.25	0.41
D1	.712	.720	18.08	18.29	c1	.007	.011	0.18	0.28
E	.551	.559	14.00	14.20	e	.020 BSC		0.51 BSC	
E1	.353	.357	8.97	9.07	e1	.040 BSC		1.02 BSC	
E2	.346	.350	8.79	8.89	e2	.253 INFO ONLY		6.43 INFO ONLY	
E3	.132	.140	3.35	3.56	e3	.120 BSC		3.05 BSC	
F	.025 BSC		0.64 BSC		aaa	.004		0.10	
					bbb	.008		0.20	

© FREESCALE SEMICONDUCTOR, INC. ALL RIGHTS RESERVED.		MECHANICAL OUTLINE		PRINT VERSION NOT TO SCALE	
TITLE: TO-270WB-15			DOCUMENT NO: 98ASA00630D		REV: 0
			STANDARD: NON-JEDEC		
			17 JUN 2014		

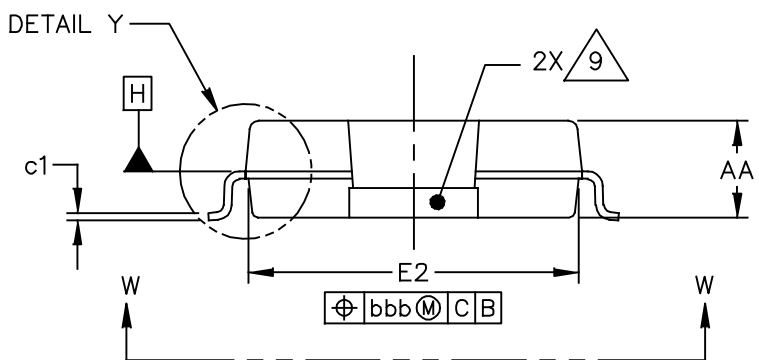
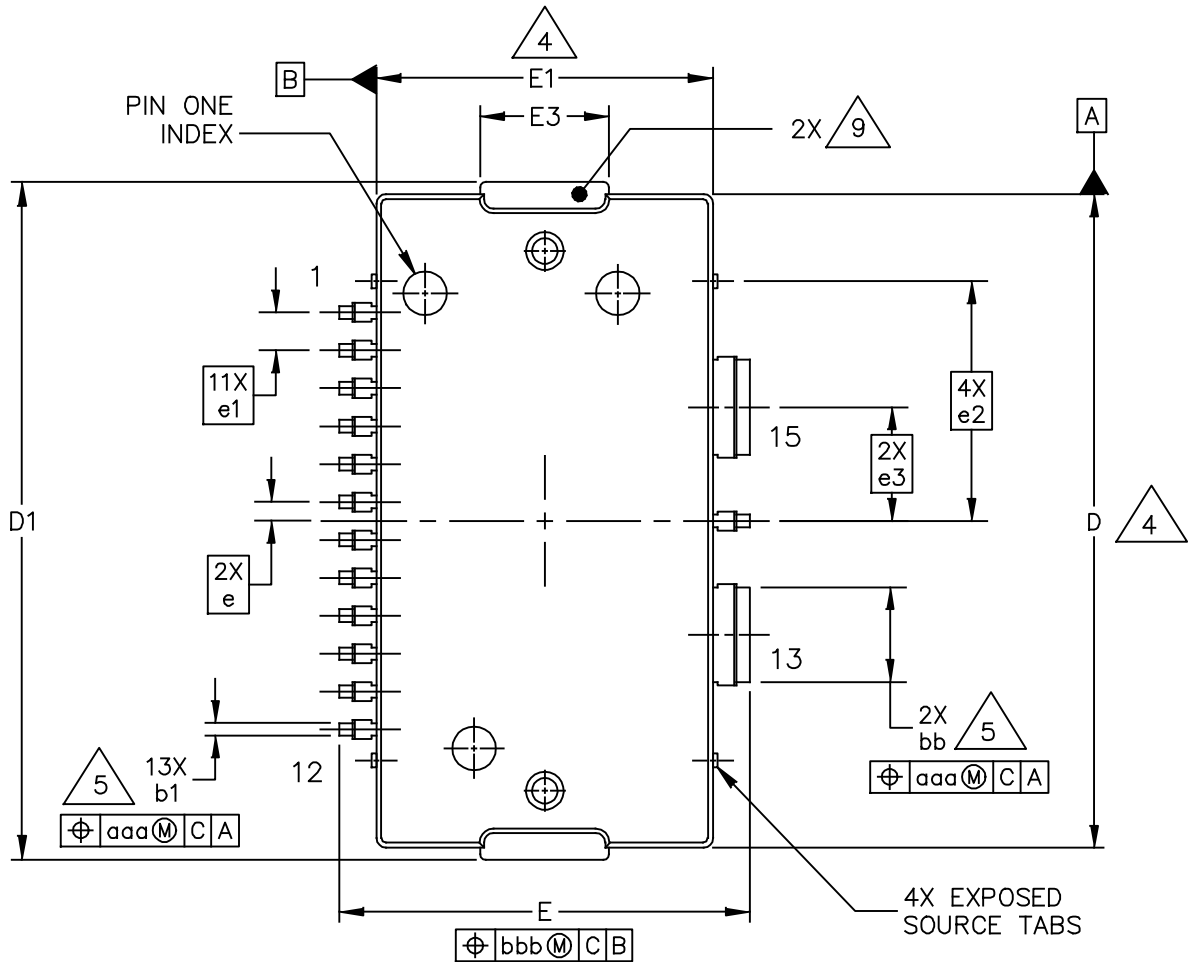

© FREESCALE SEMICONDUCTOR, INC. ALL RIGHTS RESERVED.	MECHANICAL OUTLINE	PRINT VERSION NOT TO SCALE
TITLE:  TO-270WBG-15	DOCUMENT NO: 98ASA00684D      REV: 0	
	STANDARD: NON-JEDEC	
	17 JUN 2014	

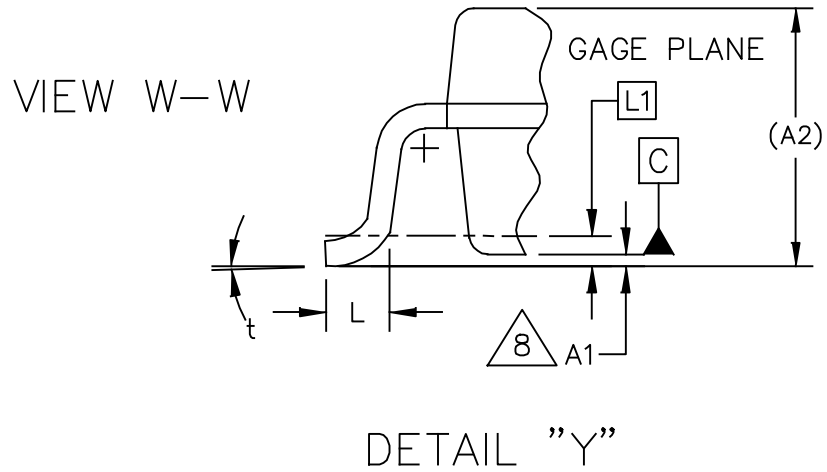
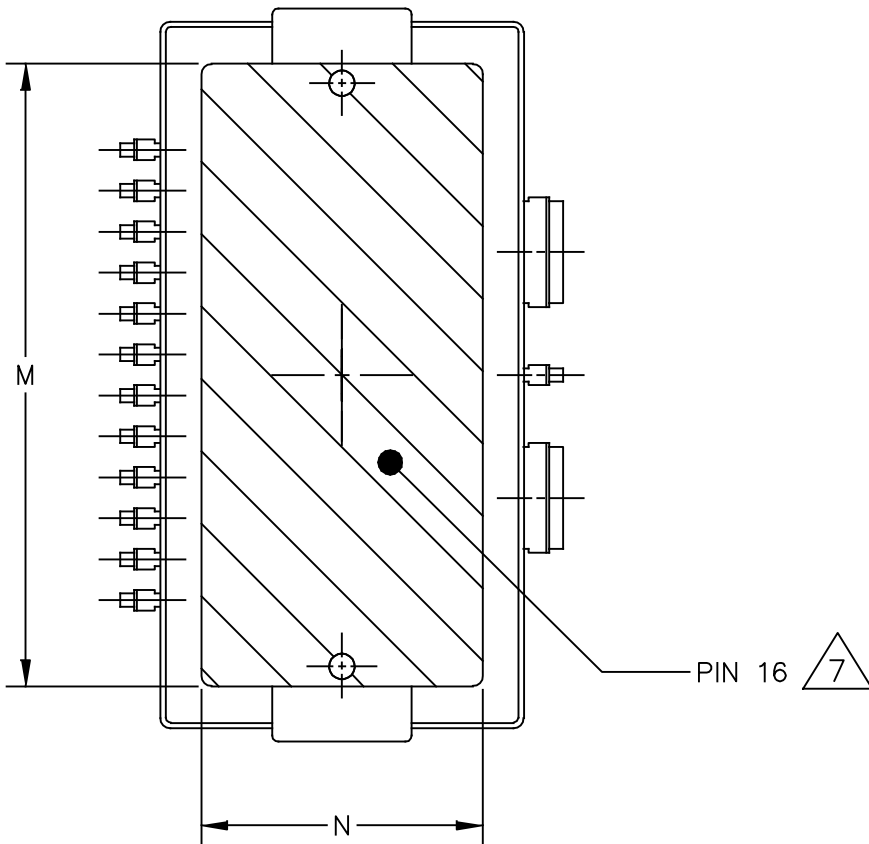

© FREESCALE SEMICONDUCTOR, INC. ALL RIGHTS RESERVED.	MECHANICAL OUTLINE	PRINT VERSION NOT TO SCALE
TITLE:  TO-270WBG-15	DOCUMENT NO: 98ASA00684D	REV: 0
	STANDARD: NON-JEDEC	
	17 JUN 2014	

NOTES:

1. CONTROLLING DIMENSION: INCH
2. INTERPRET DIMENSIONS AND TOLERANCES PER ASME Y14.5M-1994.
3. DATUM PLANE H IS LOCATED AT THE TOP OF LEAD AND IS COINCIDENT WITH THE LEAD WHERE THE LEAD EXITS THE PLASTIC BODY AT THE TOP OF THE PARTING LINE.
4. DIMENSIONS D AND E1 DO NOT INCLUDE MOLD PROTRUSION. ALLOWABLE PROTRUSION IS .006 INCH (0.15 MM) PER SIDE. DIMENSIONS D AND E1 DO INCLUDE MOLD MISMATCH AND ARE DETERMINED AT DATUM PLANE H.
5. DIMENSIONS bb AND b1 DO NOT INCLUDE DAMBAR PROTRUSION. ALLOWABLE DAMBAR PROTRUSION SHALL BE .005 INCH (0.13 MM) TOTAL IN EXCESS OF THE bb AND b1 DIMENSIONS AT MAXIMUM MATERIAL CONDITION.
6. DATUMS A AND B TO BE DETERMINED AT DATUM PLANE H.
7. HATCHING REPRESENTS THE EXPOSED AND SOLDERABLE AREA OF THE HEAT SLUG. DIMENSIONS M AND N REPRESENT THE VALUES BETWEEN THE TWO OPPOSITE POINTS ALONG THE EDGES OF EXPOSED AREA OF THE HEAT SLUG.
8. DIMENSION A1 IS MEASURED WITH REFERENCE TO DATUM C. THE POSITIVE VALUE IMPLIES THAT THE BOTTOM OF THE PACKAGE IS HIGHER THAN THE BOTTOM OF THE LEAD.
9. THESE SURFACES OF THE HEAT SLUG ARE NOT PART OF THE SOLDERABLE SURFACES AND MAY REMAIN UNPLATED.

DIM	INCH		MILLIMETER		DIM	INCH		MILLIMETER	
	MIN	MAX	MIN	MAX		MIN	MAX	MIN	MAX
AA	.099	.105	2.51	2.67	M	.600	----	15.24	----
A1	.001	.004	0.03	0.10	N	.270	----	6.86	----
A2	(.105)		(2.67)		bb	.097	.103	2.46	2.62
D	.688	.692	17.48	17.58	b1	.010	.016	0.25	0.41
D1	.712	.720	18.08	18.29	c1	.007	.011	0.18	0.28
E	.429	.437	10.90	11.10	e	.020 BSC		0.51 BSC	
E1	.353	.357	8.97	9.07	e1	.040 BSC		1.02 BSC	
E2	.346	.350	8.79	8.89	e2	.253 INFO ONLY		6.43 INFO ONLY	
E3	.132	.140	3.35	3.56	e3	.120 BSC		3.05 BSC	
L	.018	.024	0.46	0.61	t	2°	8°	2°	8°
L1	.010 BSC		0.25 BSC		aaa	.004		0.10	
					bbb	.008		0.20	

© FREESCALE SEMICONDUCTOR, INC. ALL RIGHTS RESERVED.		MECHANICAL OUTLINE	PRINT VERSION NOT TO SCALE
TITLE:  TO-270WBG-15		DOCUMENT NO: 98ASA00684D	REV: 0
		STANDARD: NON-JEDEC	
			17 JUN 2014

## PRODUCT DOCUMENTATION, SOFTWARE AND TOOLS

Refer to the following resources to aid your design process.

### Application Notes

- AN1907: Solder Reflow Attach Method for High Power RF Devices in Over-Molded Plastic Packages
- AN1955: Thermal Measurement Methodology of RF Power Amplifiers
- AN1977: Quiescent Current Thermal Tracking Circuit in the RF Integrated Circuit Family
- AN1987: Quiescent Current Control for the RF Integrated Circuit Device Family

### Engineering Bulletins

- EB212: Using Data Sheet Impedances for RF LDMOS Devices

### Software

- Electromigration MTTF Calculator
- RF High Power Model
- .s2p File

### Development Tools

- Printed Circuit Boards

### To Download Resources Specific to a Given Part Number:

1. Go to <http://www.nxp.com/RF>
2. Search by part number
3. Click part number link
4. Choose the desired resource from the drop down menu

## REVISION HISTORY

The following table summarizes revisions to this document.

Revision	Date	Description
0	Feb. 2016	• Initial release of data sheet