



RF Power LDMOS Transistor

N-Channel Enhancement-Mode Lateral MOSFET

This 71 W asymmetrical Doherty RF power LDMOS transistor is designed for cellular base station applications requiring very wide instantaneous bandwidth capability covering the frequency range of 1805 to 1880 MHz.

1800 MHz

- Typical Doherty Single-Carrier W-CDMA Performance: $V_{DD} = 28$ Vdc, $I_{DQA} = 300$ mA, $V_{GSB} = 0.7$ Vdc, $P_{out} = 71$ W Avg., Input Signal PAR = 9.9 dB @ 0.01% Probability on CCDF.

Frequency	G_{ps} (dB)	η_D (%)	Output PAR (dB)	ACPR (dBc)
1805 MHz	17.0	53.2	7.8	-31.0
1840 MHz	17.1	53.4	7.6	-31.6
1880 MHz	16.8	52.8	7.4	-32.5

Features

- Advanced high performance in-package Doherty
- Designed for wide instantaneous bandwidth applications
- Greater negative gate-source voltage range for improved Class C operation
- Able to withstand extremely high output VSWR and broadband operating conditions
- Designed for digital predistortion error correction systems

A3T18H400W23SR6

1805–1880 MHz, 71 W AVG., 28 V AIRFAST RF POWER LDMOS TRANSISTOR

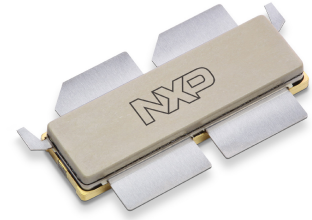

ACP-1230S-4L2S

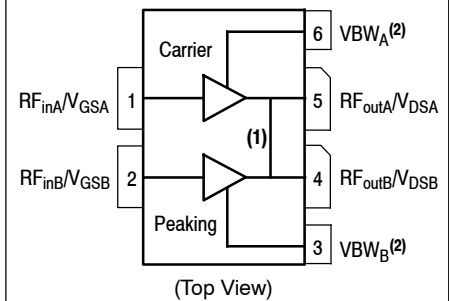

Figure 1. Pin Connections

- Pin connections 4 and 5 are DC coupled and RF independent.
- Device can operate with V_{DD} current supplied through pin 3 and pin 6.

Table 1. Maximum Ratings

Rating	Symbol	Value	Unit
Drain-Source Voltage	V_{DSS}	-0.5, +65	Vdc
Gate-Source Voltage	V_{GS}	-6.0, +10	Vdc
Operating Voltage	V_{DD}	32, +0	Vdc
Storage Temperature Range	T_{stg}	-65 to +150	°C
Case Operating Temperature Range	T_C	-40 to +150	°C
Operating Junction Temperature Range (1,2)	T_J	-40 to +225	°C
CW Operation @ $T_C = 25^\circ\text{C}$ when DC current is fed through pin 3 and pin 6 Derate above 25°C	CW	173 0.9	W W/°C

Table 2. Thermal Characteristics

Characteristic	Symbol	Value (2,3)	Unit
Thermal Resistance, Junction to Case Case Temperature 73°C , 71 W Avg., W-CDMA, 28 Vdc, $I_{DQA} = 300\text{ mA}$, $V_{GSB} = 0.7\text{ Vdc}$, 1840 MHz	$R_{\theta JC}$	0.18	°C/W

Table 3. ESD Protection Characteristics

Test Methodology	Class
Human Body Model (per JESD22-A114)	2
Charge Device Model (per JESD22-C101)	C3

Table 4. Electrical Characteristics ($T_A = 25^\circ\text{C}$ unless otherwise noted)

Characteristic	Symbol	Min	Typ	Max	Unit
----------------	--------	-----	-----	-----	------

Off Characteristics (4)

Zero Gate Voltage Drain Leakage Current ($V_{DS} = 65\text{ Vdc}$, $V_{GS} = 0\text{ Vdc}$)	I_{DSS}	—	—	10	μAdc
Zero Gate Voltage Drain Leakage Current ($V_{DS} = 32\text{ Vdc}$, $V_{GS} = 0\text{ Vdc}$)	I_{DSS}	—	—	5	μAdc
Gate-Source Leakage Current ($V_{GS} = 5\text{ Vdc}$, $V_{DS} = 0\text{ Vdc}$)	I_{GSS}	—	—	1	μAdc

On Characteristics - Side A, Carrier

Gate Threshold Voltage ($V_{DS} = 10\text{ Vdc}$, $I_D = 140\ \mu\text{Adc}$)	$V_{GS(th)}$	1.3	1.9	2.3	Vdc
Gate Quiescent Voltage ($V_{DD} = 28\text{ Vdc}$, $I_{DA} = 300\text{ mAdc}$, Measured in Functional Test)	$V_{GSA(Q)}$	2.2	2.6	3.0	Vdc
Drain-Source On-Voltage ($V_{GS} = 10\text{ Vdc}$, $I_D = 1.4\text{ Adc}$)	$V_{DS(on)}$	0.1	0.2	0.3	Vdc

On Characteristics - Side B, Peaking

Gate Threshold Voltage ($V_{DS} = 10\text{ Vdc}$, $I_D = 320\ \mu\text{Adc}$)	$V_{GS(th)}$	0.8	1.3	1.8	Vdc
Drain-Source On-Voltage ($V_{GS} = 10\text{ Vdc}$, $I_D = 3.2\text{ Adc}$)	$V_{DS(on)}$	0.1	0.2	0.3	Vdc

1. Continuous use at maximum temperature will affect MTTF.
2. MTTF calculator available at <http://www.nxp.com/RF/calculators>.
3. Refer to AN1955, *Thermal Measurement Methodology of RF Power Amplifiers*. Go to <http://www.nxp.com/RF> and search for AN1955.
4. Side A and Side B are tied together for these measurements.

(continued)

Table 4. Electrical Characteristics ($T_A = 25^\circ\text{C}$ unless otherwise noted) (continued)

Characteristic	Symbol	Min	Typ	Max	Unit
Functional Tests ^(1,2,3) (In NXP Doherty Test Fixture, 50 ohm system) $V_{DD} = 28\text{ Vdc}$, $I_{DQA} = 300\text{ mA}$, $V_{GSB} = 0.7\text{ Vdc}$, $P_{out} = 71\text{ W Avg.}$, $f = 1880\text{ MHz}$, Single-Carrier W-CDMA, IQ Magnitude Clipping, Input Signal PAR = 9.9 dB @ 0.01% Probability on CCDF. ACPR measured in 3.84 MHz Channel Bandwidth @ $\pm 5\text{ MHz}$ Offset.					
Power Gain	G_{ps}	16.0	16.8	18.8	dB
Drain Efficiency	η_D	49.0	52.8	—	%
P_{out} @ 3 dB Compression Point, CW	P3dB	55.3	56.1	—	dBm
Adjacent Channel Power Ratio	ACPR	—	-32.5	-29.0	dBc

Load Mismatch ⁽³⁾ (In NXP Doherty Test Fixture, 50 ohm system) $I_{DQA} = 300\text{ mA}$, $V_{GSB} = 0.7\text{ Vdc}$, $f = 1840\text{ MHz}$, $12\ \mu\text{sec(on)}$, 10% Duty Cycle

VSWR 10:1 at 32 Vdc, 468 W Pulsed CW Output Power (3 dB Input Overdrive from 234 W Pulsed CW Rated Power)	No Device Degradation
--	-----------------------

Typical Performance ⁽³⁾ (In NXP Doherty Test Fixture, 50 ohm system) $V_{DD} = 28\text{ Vdc}$, $I_{DQA} = 300\text{ mA}$, $V_{GSB} = 0.7\text{ Vdc}$, 1805-1880 MHz Bandwidth

P_{out} @ 3 dB Compression Point ⁽⁴⁾	P3dB	—	427	—	W
AM/PM (Maximum value measured at the P3dB compression point across the 1805-1880 MHz bandwidth)	Φ	—	-20	—	°
VBW Resonance Point (IMD Third Order Intermodulation Inflection Point)	VBW_{res}	—	190	—	MHz
Gain Flatness in 75 MHz Bandwidth @ $P_{out} = 71\text{ W Avg.}$	G_F	—	0.4	—	dB
Gain Variation over Temperature (-30°C to +85°C)	ΔG	—	0.005	—	dB/°C
Output Power Variation over Temperature (-30°C to +85°C)	ΔP_{1dB}	—	0.006	—	dB/°C

Table 5. Ordering Information

Device	Tape and Reel Information	Package
A3T18H400W23SR6	R6 Suffix = 150 Units, 56 mm Tape Width, 13-inch Reel	ACP-1230S-4L2S

- V_{DDA} and V_{ddb} must be tied together and powered by a single DC power supply.
- Part internally matched both on input and output.
- Measurements made with device in an asymmetrical Doherty configuration.
- $P_{3dB} = P_{avg} + 7.0\text{ dB}$ where P_{avg} is the average output power measured using an unclipped W-CDMA single-carrier input signal where output PAR is compressed to 7.0 dB @ 0.01% probability on CCDF.

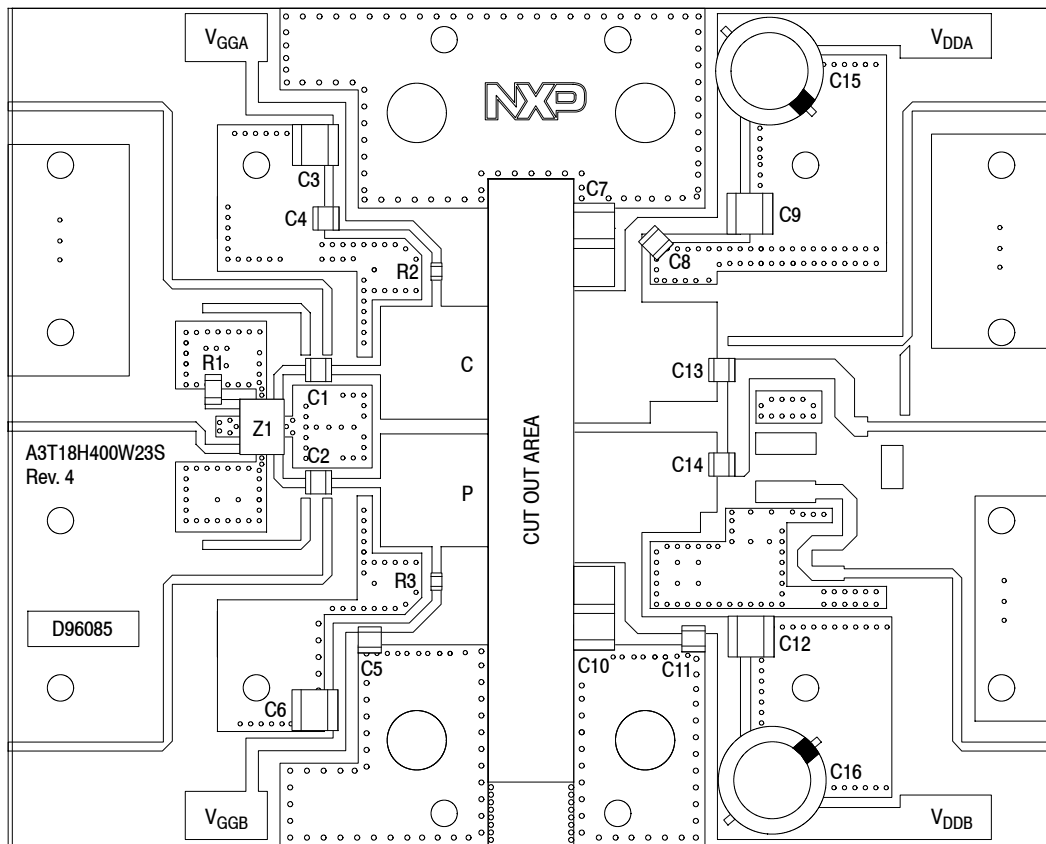

Note: V_{DDA} and V_{DDB} must be tied together and powered by a single DC power supply.

Figure 2. A3T18H400W23SR6 Test Circuit Component Layout

Table 6. A3T18H400W23SR6 Test Circuit Component Designations and Values

Part	Description	Part Number	Manufacturer
C1, C2, C4, C5, C8, C11, C14	12 pF Chip Capacitor	ATC100B120JT500XT	ATC
C3, C6, C7, C9, C10, C12	10 μ F Chip Capacitor	C5750X7S2A106M230KB	TDK
C13	6.8 pF Chip Capacitor	ATC100B6R8CT500XT	ATC
C15, C16	470 μ F, 63 V Electrolytic Capacitor	MCGPR63V477M13X26-RH	Multicomp
R1	50 Ω , 4 W Termination Chip Resistor	ATCCW12010T0050GBK	ATC
R2, R3	2.4 Ω , 1/4 W Chip Resistor	CRCW12062R40FKEA	Vishay
Z1	1700–2000 MHz Band, 90°, 2 dB Directional Coupler	CMX19Q02	RN2
PCB	Rogers RO4350B, 0.020", $\epsilon_r = 3.66$	D96085	MTL

TYPICAL CHARACTERISTICS — 1805–1880 MHz

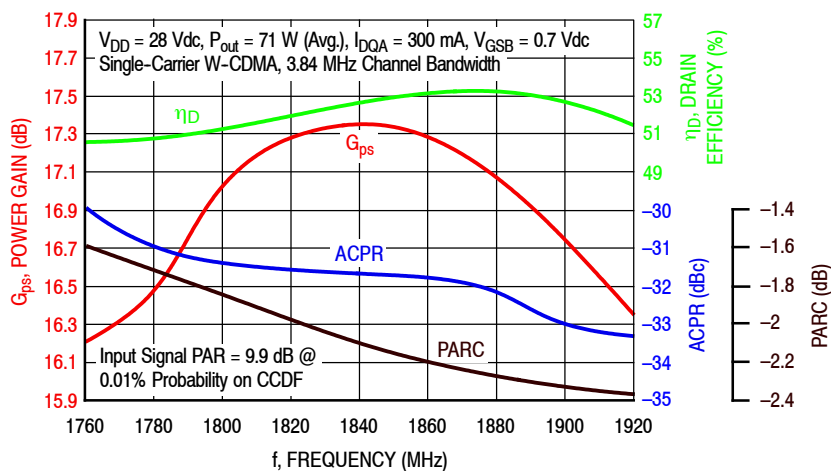

Figure 3. Single-Carrier Output Peak-to-Average Ratio Compression (PARC) Broadband Performance @ $P_{out} = 71$ Watts Avg.

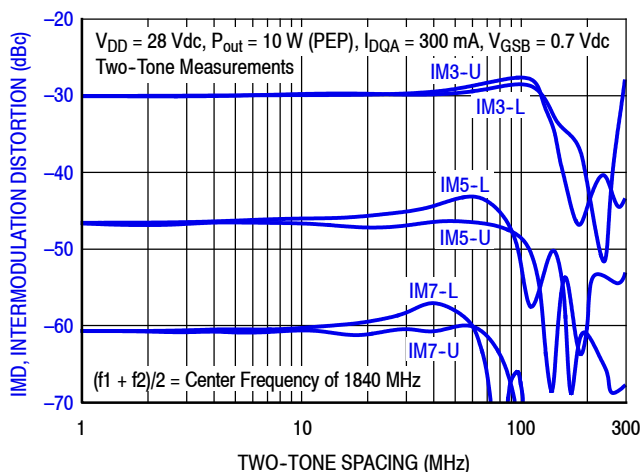

Figure 4. Intermodulation Distortion Products versus Two-Tone Spacing

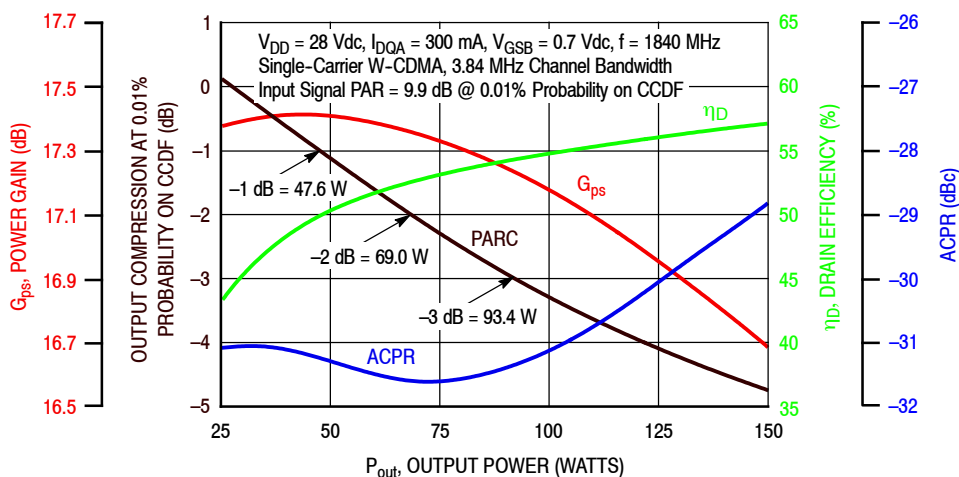

Figure 5. Output Peak-to-Average Ratio Compression (PARC) versus Output Power

TYPICAL CHARACTERISTICS — 1805–1880 MHz

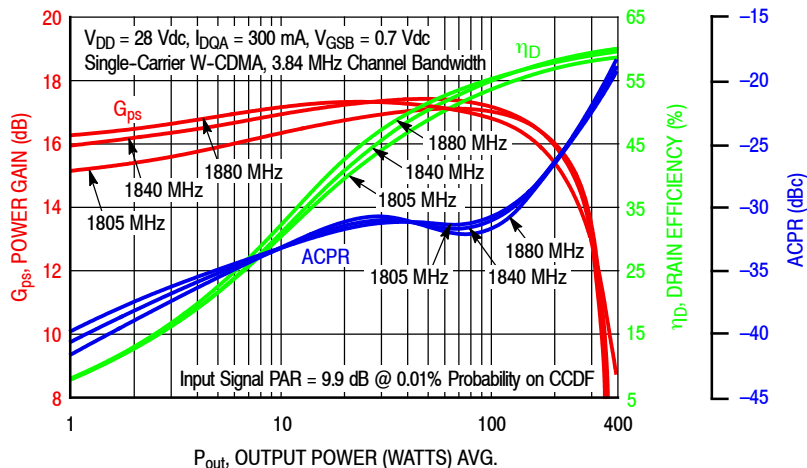

Figure 6. Single-Carrier W-CDMA Power Gain, Drain Efficiency and ACPR versus Output Power

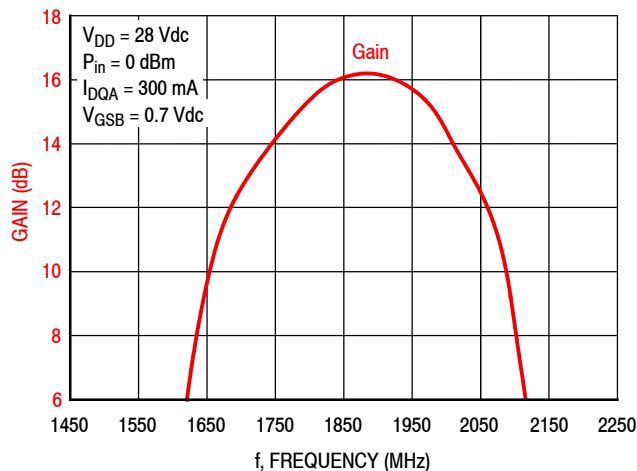

Figure 7. Broadband Frequency Response

Table 7. Carrier Side Load Pull Performance — Maximum Power Tuning

$V_{DD} = 28$ Vdc, $I_{DQA} = 693$ mA, Pulsed CW, 10 μ sec(on), 10% Duty Cycle

f (MHz)	Z_{source} (Ω)	Z_{in} (Ω)	Max Output Power					
			P1dB					
			$Z_{load}^{(1)}$ (Ω)	Gain (dB)	(dBm)	(W)	η_D (%)	AM/PM ($^\circ$)
1805	1.14 – j4.36	1.70 + j4.09	1.09 – j4.02	20.7	52.3	170	60.7	–14
1840	1.50 – j4.52	2.10 + j4.51	1.05 – j4.12	20.7	52.3	169	60.4	–13
1880	2.35 – j4.93	2.76 + j4.93	1.02 – j4.20	20.8	52.3	169	59.7	–13

f (MHz)	Z_{source} (Ω)	Z_{in} (Ω)	Max Output Power					
			P3dB					
			$Z_{load}^{(2)}$ (Ω)	Gain (dB)	(dBm)	(W)	η_D (%)	AM/PM ($^\circ$)
1805	1.14 – j4.36	1.51 + j4.44	1.07 – j4.12	18.6	53.1	204	62.8	–20
1840	1.50 – j4.52	1.91 + j4.93	1.05 – j4.21	18.7	53.1	202	62.5	–20
1880	2.35 – j4.93	2.67 + j5.53	1.03 – j4.33	18.7	53.0	201	61.8	–19

(1) Load impedance for optimum P1dB power.

(2) Load impedance for optimum P3dB power.

Z_{source} = Measured impedance presented to the input of the device at the package reference plane.

Z_{in} = Impedance as measured from gate contact to ground.

Z_{load} = Measured impedance presented to the output of the device at the package reference plane.

Table 8. Carrier Side Load Pull Performance — Maximum Efficiency Tuning

$V_{DD} = 28$ Vdc, $I_{DQA} = 693$ mA, Pulsed CW, 10 μ sec(on), 10% Duty Cycle

f (MHz)	Z_{source} (Ω)	Z_{in} (Ω)	Max Drain Efficiency					
			P1dB					
			$Z_{load}^{(1)}$ (Ω)	Gain (dB)	(dBm)	(W)	η_D (%)	AM/PM ($^\circ$)
1805	1.14 – j4.36	1.53 + j4.22	2.13 – j3.21	23.3	50.8	120	71.6	–21
1840	1.50 – j4.52	1.90 + j4.66	2.21 – j3.12	23.6	50.3	108	71.6	–21
1880	2.35 – j4.93	2.57 + j5.08	1.95 – j3.42	23.3	50.7	118	70.5	–19

f (MHz)	Z_{source} (Ω)	Z_{in} (Ω)	Max Drain Efficiency					
			P3dB					
			$Z_{load}^{(2)}$ (Ω)	Gain (dB)	(dBm)	(W)	η_D (%)	AM/PM ($^\circ$)
1805	1.14 – j4.36	1.40 + j4.48	2.46 – j3.45	21.4	51.2	131	72.6	–28
1840	1.50 – j4.52	1.73 + j4.97	2.25 – j3.32	21.5	51.1	130	73.3	–28
1880	2.35 – j4.93	2.43 + j5.58	1.95 – j3.53	21.2	51.5	140	72.5	–27

(1) Load impedance for optimum P1dB efficiency.

(2) Load impedance for optimum P3dB efficiency.

Z_{source} = Measured impedance presented to the input of the device at the package reference plane.

Z_{in} = Impedance as measured from gate contact to ground.

Z_{load} = Measured impedance presented to the output of the device at the package reference plane.



Table 9. Peaking Side Load Pull Performance — Maximum Power Tuning

$V_{DD} = 28$ Vdc, $V_{GSB} = 0.81$ Vdc, Pulsed CW, 10 μ sec(on), 10% Duty Cycle

f (MHz)	Z_{source} (Ω)	Z_{in} (Ω)	Max Output Power					
			P1dB					
			$Z_{load}^{(1)}$ (Ω)	Gain (dB)	(dBm)	(W)	η_D (%)	AM/PM ($^\circ$)
1805	1.27 – j5.03	1.80 + j4.59	1.91 – j4.60	15.7	55.5	356	55.9	–25
1840	1.78 – j5.77	2.31 + j4.83	2.04 – j4.87	15.5	55.6	367	56.2	–29
1880	2.94 – j6.36	3.33 + j5.17	2.27 – j5.00	15.8	55.6	361	56.7	–31

f (MHz)	Z_{source} (Ω)	Z_{in} (Ω)	Max Output Power					
			P3dB					
			$Z_{load}^{(2)}$ (Ω)	Gain (dB)	(dBm)	(W)	η_D (%)	AM/PM ($^\circ$)
1805	1.27 – j5.03	1.80 + j5.06	2.08 – j4.82	13.6	56.2	414	57.5	–31
1840	1.78 – j5.77	2.43 + j5.41	2.38 – j4.99	13.6	56.3	422	59.2	–36
1880	2.94 – j6.36	3.89 + j5.87	2.59 – j5.14	13.8	56.2	415	58.2	–37

(1) Load impedance for optimum P1dB power.

(2) Load impedance for optimum P3dB power.

Z_{source} = Measured impedance presented to the input of the device at the package reference plane.

Z_{in} = Impedance as measured from gate contact to ground.

Z_{load} = Measured impedance presented to the output of the device at the package reference plane.

Table 10. Peaking Side Load Pull Performance — Maximum Efficiency Tuning

$V_{DD} = 28$ Vdc, $V_{GSB} = 0.81$ Vdc, Pulsed CW, 10 μ sec(on), 10% Duty Cycle

f (MHz)	Z_{source} (Ω)	Z_{in} (Ω)	Max Drain Efficiency					
			P1dB					
			$Z_{load}^{(1)}$ (Ω)	Gain (dB)	(dBm)	(W)	η_D (%)	AM/PM ($^\circ$)
1805	1.27 – j5.03	1.39 + j4.47	2.73 – j1.89	17.1	53.4	219	65.7	–36
1840	1.78 – j5.77	1.82 + j4.74	2.63 – j2.64	16.9	54.2	262	67.4	–36
1880	2.94 – j6.36	2.56 + j5.14	2.26 – j2.70	17.2	54.0	250	67.6	–38

f (MHz)	Z_{source} (Ω)	Z_{in} (Ω)	Max Drain Efficiency					
			P3dB					
			$Z_{load}^{(2)}$ (Ω)	Gain (dB)	(dBm)	(W)	η_D (%)	AM/PM ($^\circ$)
1805	1.27 – j5.03	1.62 + j4.98	2.92 – j2.99	15.0	55.0	315	64.2	–41
1840	1.78 – j5.77	2.13 + j5.32	2.81 – j2.91	14.8	54.9	312	65.1	–44
1880	2.94 – j6.36	3.38 + j5.84	2.69 – j3.07	15.0	55.0	314	65.2	–45

(1) Load impedance for optimum P1dB efficiency.

(2) Load impedance for optimum P3dB efficiency.

Z_{source} = Measured impedance presented to the input of the device at the package reference plane.

Z_{in} = Impedance as measured from gate contact to ground.

Z_{load} = Measured impedance presented to the output of the device at the package reference plane.

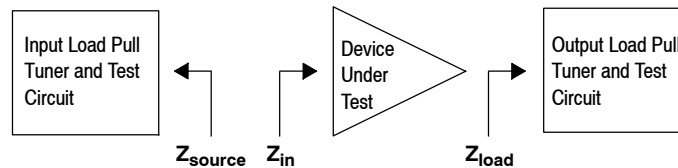

P1dB – TYPICAL CARRIER SIDE LOAD PULL CONTOURS — 1840 MHz

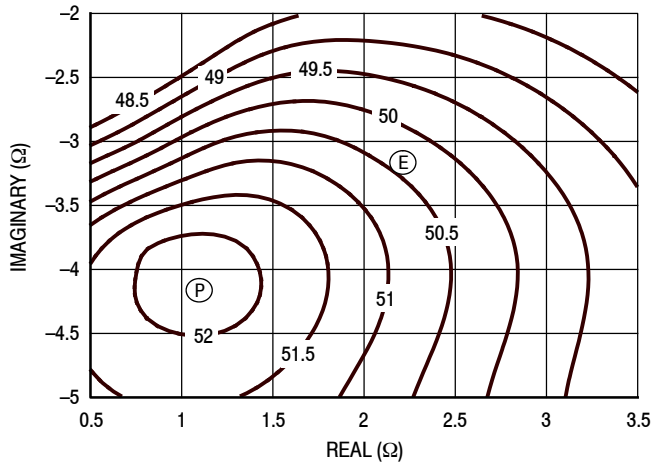

Figure 8. P1dB Load Pull Output Power Contours (dBm)

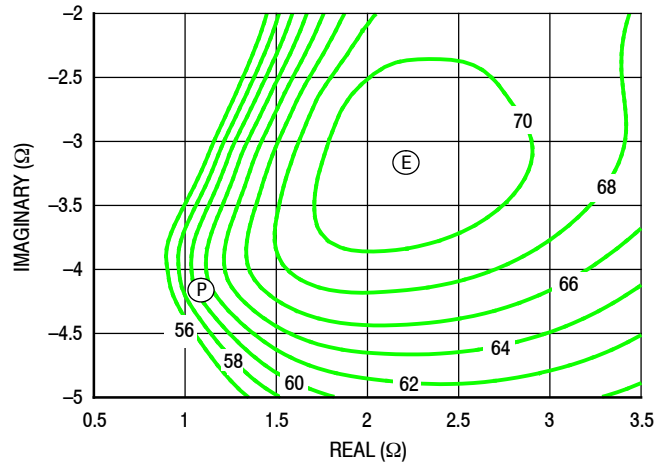

Figure 9. P1dB Load Pull Efficiency Contours (%)

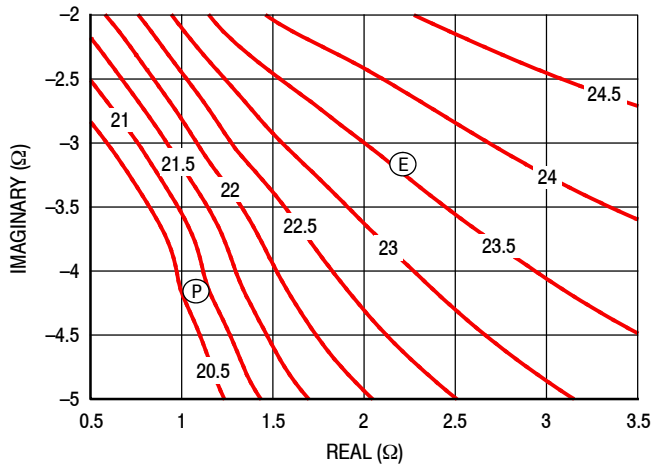

Figure 10. P1dB Load Pull Gain Contours (dB)

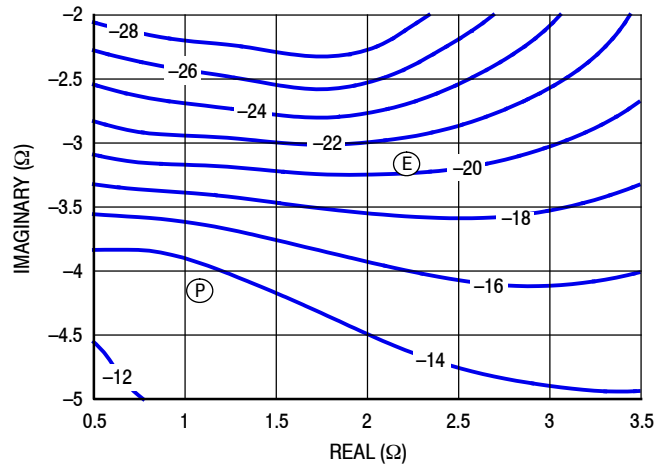

Figure 11. P1dB Load Pull AM/PM Contours (°)

NOTE: (P) = Maximum Output Power
(E) = Maximum Drain Efficiency

- Gain
- Drain Efficiency
- Linearity
- Output Power

P3dB – TYPICAL CARRIER SIDE LOAD PULL CONTOURS — 1840 MHz

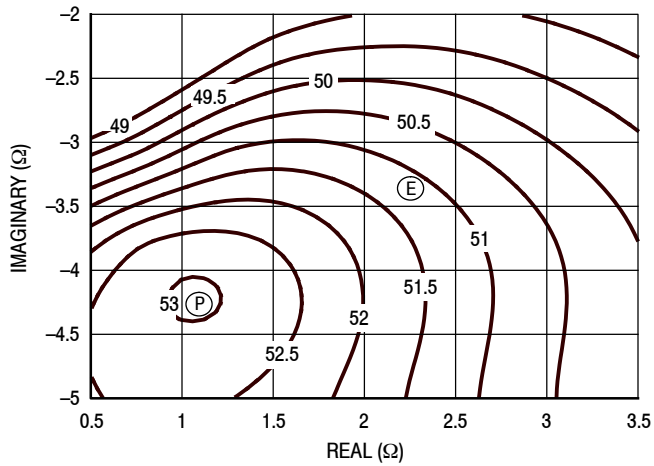

Figure 12. P3dB Load Pull Output Power Contours (dBm)

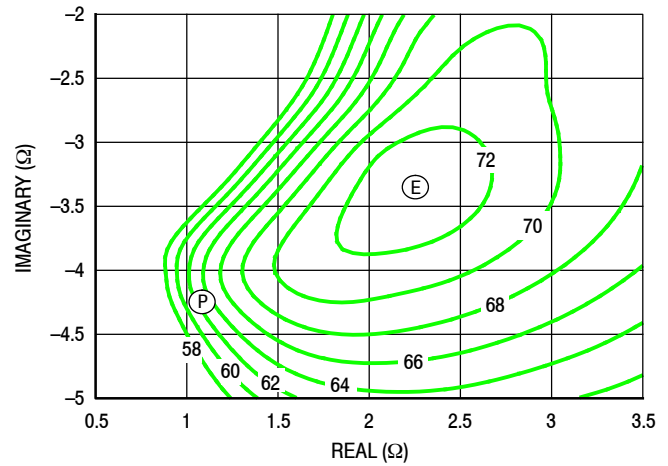

Figure 13. P3dB Load Pull Efficiency Contours (%)

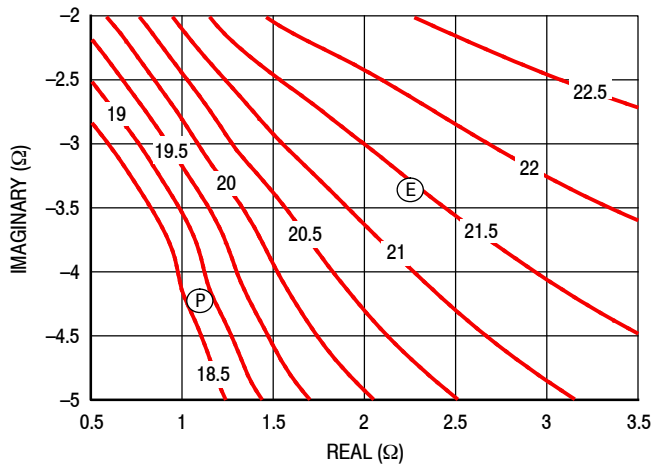

Figure 14. P3dB Load Pull Gain Contours (dB)

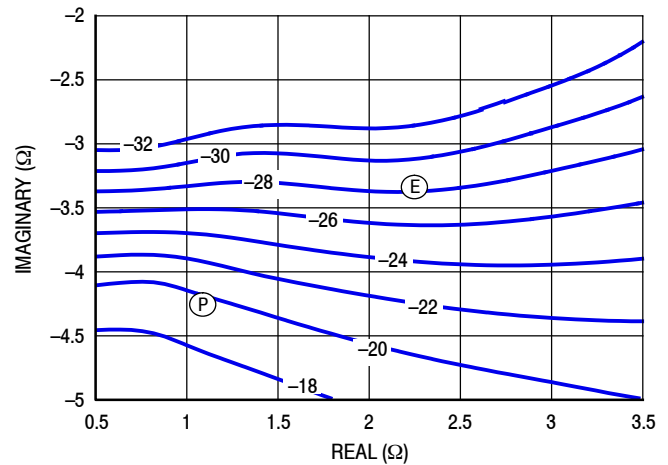

Figure 15. P3dB Load Pull AM/PM Contours (°)

NOTE: (P) = Maximum Output Power
(E) = Maximum Drain Efficiency

- Gain
- Drain Efficiency
- Linearity
- Output Power

P1dB – TYPICAL PEAKING SIDE LOAD PULL CONTOURS — 1840 MHz

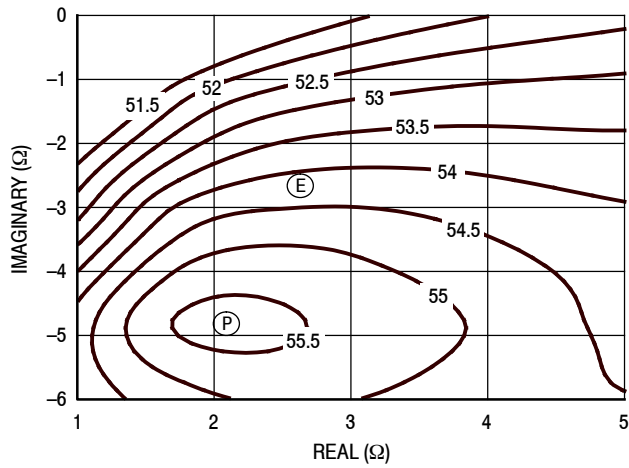

Figure 16. P1dB Load Pull Output Power Contours (dBm)

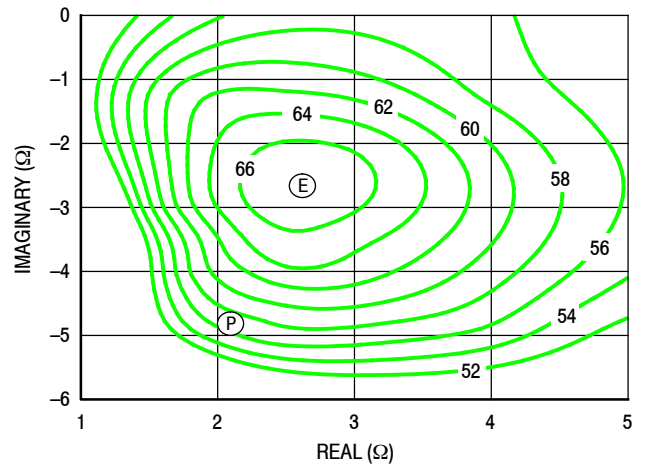

Figure 17. P1dB Load Pull Efficiency Contours (%)

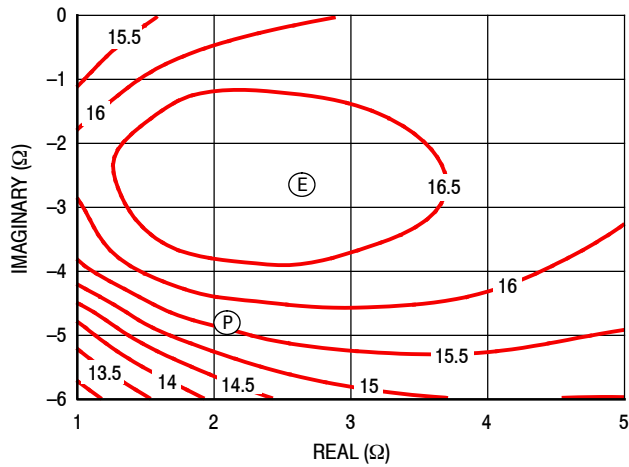

Figure 18. P1dB Load Pull Gain Contours (dB)

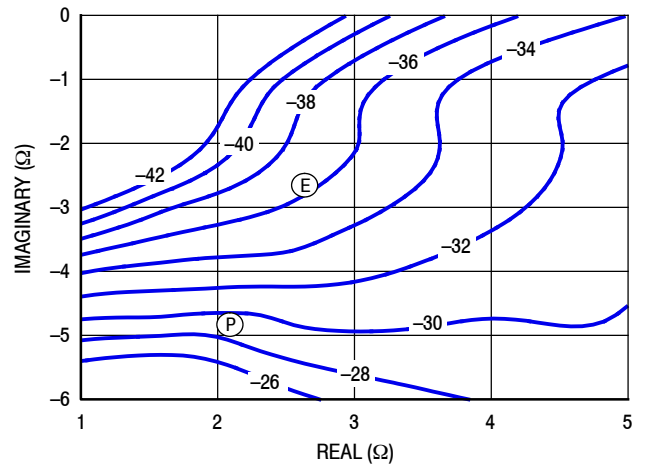

Figure 19. P1dB Load Pull AM/PM Contours (°)

NOTE: (P) = Maximum Output Power
(E) = Maximum Drain Efficiency

- Gain
- Drain Efficiency
- Linearity
- Output Power

P3dB – TYPICAL PEAKING SIDE LOAD PULL CONTOURS — 1840 MHz

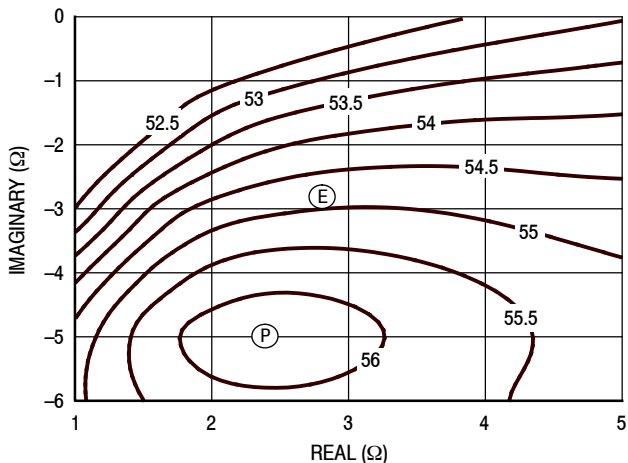

Figure 20. P3dB Load Pull Output Power Contours (dBm)

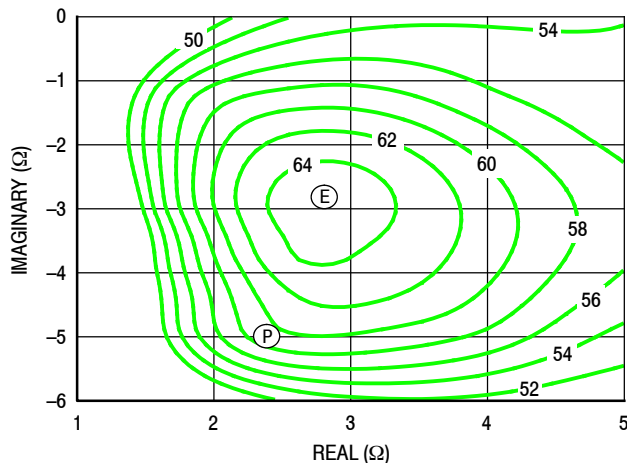

Figure 21. P3dB Load Pull Efficiency Contours (%)

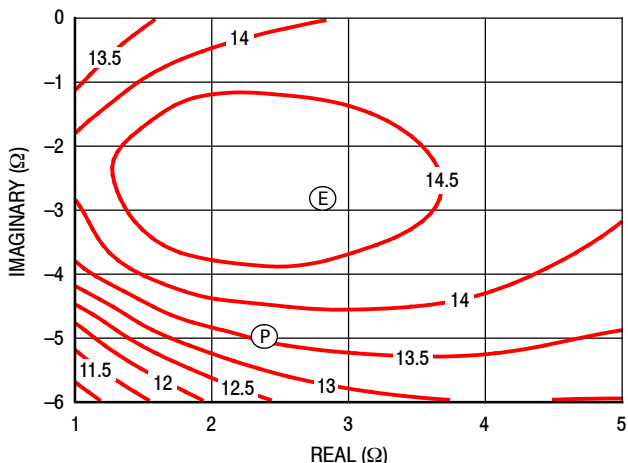

Figure 22. P3dB Load Pull Gain Contours (dB)

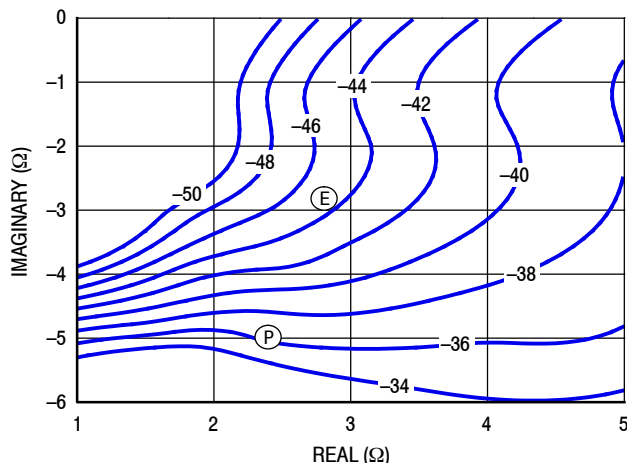
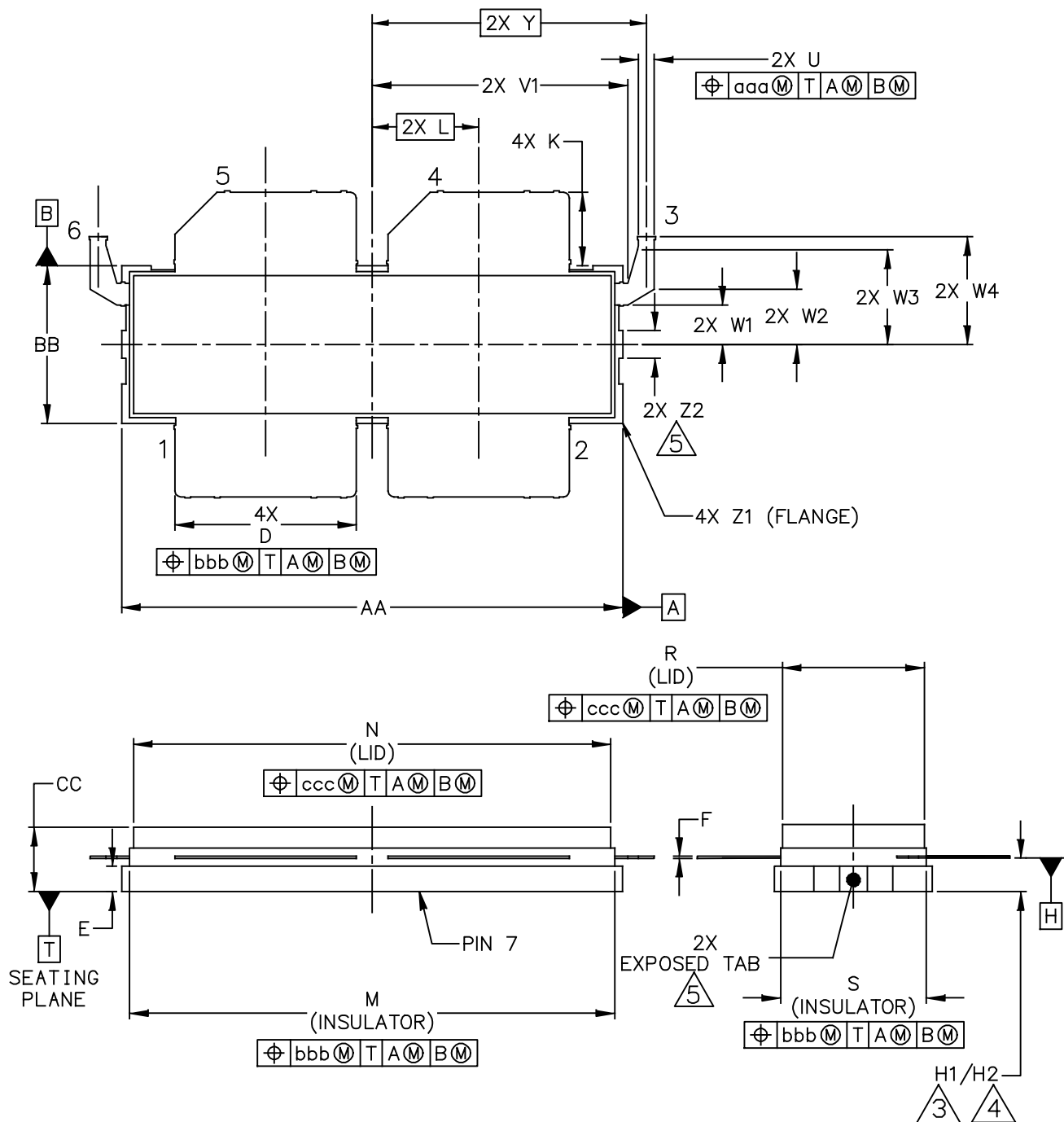

Figure 23. P3dB Load Pull AM/PM Contours (°)

NOTE: (P) = Maximum Output Power
 (E) = Maximum Drain Efficiency

- Gain
- Drain Efficiency
- Linearity
- Output Power

PACKAGE DIMENSIONS



© NXP SEMICONDUCTORS N. V. ALL RIGHTS RESERVED	MECHANICAL OUTLINE	PRINT VERSION NOT TO SCALE
TITLE: ACP-1230S-4L2S	DOCUMENT NO: 98ASA00974D	REV: A
	STANDARD: NON-JEDEC	
	SOT1800-4	21 JUN 2017

NOTES:

1. INTERPRET DIMENSIONS AND TOLERANCES PER ASME Y14.5M-1994.

2. CONTROLLING DIMENSION: INCH

3. DIMENSIONS H1 AND H2 ARE MEASURED .030 INCH (0.762 MM) AWAY FROM FLANGE PARALLEL TO DATUM B. H1 APPLIES TO PINS 1, 2, 4 & 5. H2 APPLIES TO PINS 3 & 6.

4. TOLERANCE OF DIMENSION H2 IS TENTATIVE.

5. THESE SURFACES OF THE HEAT SLUG ARE NOT PART OF THE SOLDERABLE SURFACES AND MAY REMAIN UNPLATED.

6. DATUM H IS LOCATED AT THE BOTTOM OF THE LEAD FRAME AND IS COINCIDENT WITH THE LEAD WHERE THE LEADS EXIT THE PLASTIC BODY.

7. DIMENSIONS M AND S DO NOT INCLUDE MOLD PROTRUSION. ALLOWABLE PROTRUSION IS .012 INCH (0.30 MM) PER SIDE. DIMENSIONS M AND S DO INCLUDE MOLD MISMATCH AND ARE DETERMINED AT DATUM PLANE H.

8. DIMENSIONS D, U AND K DO NOT INCLUDE DAMBAR PROTRUSION. ALLOWABLE DAMBAR PROTRUSION SHALL BE .010 INCH (0.25 MM) TOTAL IN EXCESS OF THE D, U AND K DIMENSION AT MAXIMUM MATERIAL CONDITION.

9. DATUM A AND B TO BE DETERMINED AT DATUM T.

DIM	INCHES		MILLIMETERS		DIM	INCHES		MILLIMETERS	
	MIN	MAX	MIN	MAX		MIN	MAX	MIN	MAX
AA	1.265	1.275	32.13	32.39	S	.365	.375	9.27	9.53
BB	.395	.405	10.03	10.29	U	.035	.045	0.89	1.14
CC	.160	.190	4.06	4.83	V1	.640	.655	16.26	16.64
D	.455	.465	11.56	11.81	W1	.105	.115	2.67	2.92
E	.062	.069	1.57	1.75	W2	.135	.145	3.43	3.68
F	.004	.007	0.10	0.18	W3	.245	.255	6.22	6.48
H1	.082	.090	2.08	2.29	W4	.265	.281	6.73	7.14
H2	.078	.094	1.98	2.39	Y	0.695 BSC		17.65 BSC	
K	.175	.195	4.45	4.95	Z1	R.000	R.040	R0.00	R1.02
L	0.270 BSC		6.86 BSC		Z2	.060	.100	1.52	2.54
M	1.219	1.241	30.96	31.52	aaa	.015		0.38	
N	1.218	1.242	30.94	31.55	bbb	.010		0.25	
R	.365	.375	9.27	9.53	ccc	.020		0.51	

© NXP SEMICONDUCTORS N.V.
ALL RIGHTS RESERVED

MECHANICAL OUTLINE

PRINT VERSION NOT TO SCALE

TITLE:

ACP-1230S-4L2S

DOCUMENT NO: 98ASA00974D

REV: A

STANDARD: NON-JEDEC

SOT1800-4

21 JUN 2017

PRODUCT DOCUMENTATION, SOFTWARE AND TOOLS

Refer to the following resources to aid your design process.

Application Notes

- AN1908: Solder Reflow Attach Method for High Power RF Devices in Air Cavity Packages
- AN1955: Thermal Measurement Methodology of RF Power Amplifiers

Engineering Bulletins

- EB212: Using Data Sheet Impedances for RF LDMOS Devices

Software

- Electromigration MTTF Calculator
- RF High Power Model
- .s2p File

Development Tools

- Printed Circuit Boards

To Download Resources Specific to a Given Part Number:

1. Go to <http://www.nxp.com/RF>
2. Search by part number
3. Click part number link
4. Choose the desired resource from the drop down menu

REVISION HISTORY

The following table summarizes revisions to this document.

Revision	Date	Description
0	Oct. 2017	<ul style="list-style-type: none">• Initial release of data sheet