



User Manual Anybus[®] Communicator[™] for DeviceNet[™]

Doc. Id. HMSI-27-305
Rev. 3.12

Important User Information

This document contains a general introduction as well as a description of the technical features provided by the Anybus Communicator, including the PC-based configuration software.

The reader of this document is expected to be familiar with PLC and software design, as well as communication systems in general. The reader is also expected to be familiar with the Microsoft® Windows® operating system.

Liability

Every care has been taken in the preparation of this manual. Please inform HMS Industrial Networks AB of any inaccuracies or omissions. The data and illustrations found in this document are not binding. We, HMS Industrial Networks AB, reserve the right to modify our products in line with our policy of continuous product development. The information in this document is subject to change without notice and should not be considered as a commitment by HMS Industrial Networks AB. HMS Industrial Networks AB assumes no responsibility for any errors that may appear in this document.

There are many applications of this product. Those responsible for the use of this device must ensure that all the necessary steps have been taken to verify that the applications meet all performance and safety requirements including any applicable laws, regulations, codes, and standards.

HMS Industrial Networks AB will under no circumstances assume liability or responsibility for any problems that may arise as a result from the use of undocumented features, timing, or functional side effects found outside the documented scope of this product. The effects caused by any direct or indirect use of such aspects of the product are undefined, and may include e.g. compatibility issues and stability issues.

The examples and illustrations in this document are included solely for illustrative purposes. Because of the many variables and requirements associated with any particular implementation, HMS Industrial Networks AB cannot assume responsibility for actual use based on these examples and illustrations.

Intellectual Property Rights

HMS Industrial Networks AB has intellectual property rights relating to technology embodied in the product described in this document. These intellectual property rights may include patents and pending patent applications in the US and other countries.

Trademark Acknowledgements

Anybus® is a registered trademark of HMS Industrial Networks AB. Microsoft® and Windows® are registered trademarks of Microsoft, Inc. DeviceNet™ and ODVA™ are trademarks of ODVA, Inc. All other trademarks are the property of their respective holders.

Warning: This is a class A product. In a domestic environment this product may cause radio interference in which case the user may be required to take adequate measures.

ESD Note: This product contains ESD (Electrostatic Discharge) sensitive parts that may be damaged if ESD control procedures are not followed. Static control precautions are required when handling the product. Failure to observe this may cause damage to the product.

Anybus Communicator DeviceNet User Manual
Copyright© HMS Industrial Networks AB
Doc: HMSI-27-305

Table of Contents

Preface	About This Document	
	Related Documents	7
	Document History	7
	Conventions & Terminology	8
	<i>Glossary</i>	8
	Support.....	8
Chapter 1	About the Anybus Communicator for DeviceNet	
	External View.....	10
	Status LEDs	11
	Configuration Switches.....	11
	Hardware Installation.....	12
	Software Installation	13
	<i>Anybus Configuration Manager</i>	13
	<i>Electronic Datasheet (EDS-file)</i>	13
Chapter 2	Basic Operation	
	General.....	14
	Data Exchange Model	15
	<i>Memory Map</i>	15
	<i>Data Exchange Example</i>	16
	Subnetwork Protocol.....	17
	<i>Protocol Modes</i>	17
	<i>Protocol Building Blocks</i>	17
	<i>Master Mode</i>	18
	<i>Generic Data Mode</i>	19
	<i>DF1 Master Mode</i>	19
	Data Representation on DeviceNet.....	20
	<i>General</i>	20
	<i>Data Types</i>	20
	<i>Memory Layout</i>	21
Chapter 3	Navigating ACM	
	Main Window.....	22
	<i>Drop-down Menus</i>	23
	<i>Toolbar Icons</i>	26

Chapter 4	Basic Settings	
	Fieldbus Settings.....	27
	Communicator Parameters	28
	Sub-network Parameters	29
Chapter 5	Nodes	
	General.....	30
	Adding & Managing Nodes.....	30
	Node Parameters	30
	<i>Master Mode and Generic Data Mode</i>	30
Chapter 6	Transactions	
	General.....	31
	Adding & Managing Transactions.....	32
	Transaction Parameters (Master Mode).....	33
	<i>Parameters (Query & Broadcast)</i>	33
	<i>Parameters (Response)</i>	34
	Transaction Parameters (Generic Data Mode).....	35
	<i>Produce Transactions</i>	35
	<i>Consume Transactions</i>	36
	Transaction Editor	37
Chapter 7	Frame Objects	
	General.....	38
	Adding and Editing Frame Objects	38
	Constant Objects (Byte, Word, Dword).....	39
	Limit Objects (Byte, Word, Dword)	40
	Data Object.....	41
	Variable Data Object	41
	Checksum Object.....	43
Chapter 8	Commands	
	General.....	44
	Adding & Managing Commands	44
	<i>Drop-down Menu</i>	45
	<i>Toolbar Icons</i>	45
	The Command Editor	46
	<i>General</i>	46
	<i>Basic Navigation</i>	46
	<i>Drop-down Menu</i>	47
	<i>Editing a Command</i>	47
	<i>Example: Specifying a Modbus-RTU Command in Master Mode</i>	48

Chapter 9	DF1 Protocol Mode	
	General.....	49
	Communicator Parameters	50
	Sub-network Parameters	51
	Node Parameters	52
	Services.....	52
	<i>Available Services</i>	53
	Integrity Check	54
	Read Diagnostics	54
	Read Data	55
	Write Data	55
Chapter 10	Sub-network Monitor	
	General.....	56
	Operation.....	56
Chapter 11	Node Monitor	
	General.....	57
	Navigating the Node Monitor.....	58
	<i>Drop-down Menu</i>	59
	<i>Toolbar Icons</i>	60
Chapter 12	Data Logger	
	General.....	61
	Operation.....	61
	Configuration	62
Chapter 13	Configuration Wizards	
	General.....	63
	Selecting a Wizard Profile	63
	Wizard - Modbus RTU Master	64
Chapter 14	Control and Status Registers	
	General.....	65
	<i>Handshaking Procedure</i>	65
	<i>Data Consistency</i>	66
	Status Register Contents (Gateway to Control System).....	67
	<i>General Information</i>	67
	<i>Status Codes in Master Mode and DF1 Master Mode</i>	67
	<i>Status Code in Generic Data Mode</i>	68
	Control Register Contents (Control System to Gateway).....	69
	<i>General Information</i>	69
	<i>Control Codes in Master Mode and DF1 Master Mode</i>	69
	<i>Control Codes in Generic Data Mode</i>	69

Chapter 15**CIP Object Implementation**

Identity Object, Class 01h.....	71
<i>General Information</i>	71
<i>Class Attributes</i>	71
<i>Instance Attributes</i>	71
Message Router, Class 02h.....	72
<i>General Information</i>	72
<i>Class Attributes</i>	72
<i>Instance Attributes</i>	72
DeviceNet Object, Class 03h	73
<i>General Information</i>	73
<i>Class Attributes</i>	73
<i>Instance Attributes</i>	73
Assembly Object, Class 04h	74
<i>General Information</i>	74
<i>Class Attributes</i>	74
<i>Instance Attributes - Instance/Connection Point 64h</i>	74
<i>Instance Attributes - Instance/Connection Point 96h</i>	74
Connection Object, Class 05h.....	75
<i>General Information</i>	75
<i>Class Attributes</i>	75
<i>Instance 1 & 10...14 (Explicit Messaging Connection) Attributes</i>	75
<i>Instance 2 (Polled Connection) Attributes</i>	75
<i>Instance 3 (Bit-strobe connection) Attributes</i>	76
<i>Instance 4 (COS/Cyclic connection) Attributes</i>	76
Acknowledge Handler Object, Class 2Bh	77
<i>General Information</i>	77
<i>Class Attributes</i>	77
<i>Instance Attributes</i>	77
Diagnostic Object, Class AAh.....	78
<i>General Information</i>	78
<i>Class Attributes</i>	78
<i>Instance Attributes, Instance 01h</i>	78
Parameter Data Input Mapping Object, Class B0h	79
<i>General Information</i>	79
<i>Class Attributes</i>	79
<i>Instance Attributes, Instance 01h</i>	79
Parameter Data Output Mapping Object, Class B1h	80
<i>General Information</i>	80
<i>Class Attributes</i>	80
<i>Instance Attributes, Instance 01h</i>	80

Chapter 16**Advanced Fieldbus Configuration**

General.....	81
Mailbox Editor.....	81

Appendix A	Parameter Data Initialization (Explicit Data)	
	General.....	82
	Add a Mailbox Message.....	82
	Mapping Input Parameter Data to DeviceNet.....	83
	Mapping Output Parameter Data to DeviceNet.....	85
Appendix B	Connector Pin Assignments	
	DeviceNet Connector.....	87
	Power Connector	87
	PC Connector	88
	Subnetwork Interface	89
	<i>General Information</i>	89
	<i>Bias Resistors (RS485 Only)</i>	89
	<i>Termination (RS485 & RS422 Only)</i>	89
	<i>Connector Pinout (DB9F)</i>	89
	<i>Typical Connection (RS485)</i>	90
	<i>Typical Connection (RS422 & 4-Wire RS485)</i>	90
	<i>Typical Connection (RS232)</i>	90
Appendix C	Technical Specification	
	Mechanical Properties.....	91
	Electrical Characteristics	91
	Environmental Characteristics	91
	Regulatory Compliance	92
Appendix D	Troubleshooting	
Appendix E	ASCII Table	

P. About This Document

For more information, documentation etc., please visit the HMS website, "www.anybus.com".

P.1 Related Documents

Document name	Author
Anybus Communicator - DeviceNet Installation Sheet	HMS
DF1 Protocol and Command Set - Reference Manual, 1770-6.5.16, October 1996	Allen-Bradley

P.2 Document History

Summary of Recent Changes (3.00... 3.10)

Change	Page(s)
Device type changed from "Group two only server" to "Group two server"	9
Screenshots and descriptions of ABC Tool updated for Anybus Configuration Manager	Multiple
Changed "ABC" to "Communicator RS232/422/485"	Multiple
Amended description of "Update time" parameter	34, 35
Added description for Consume/Response to "Object Delimiter" parameter	42
Changed "Maximum Data Length" limit	42
Removed obsolete "Start Bits" parameter	51
Removed obsolete "ABCC ExtLink Wizard" entry	64
Replaced "Sales and Support" info with link to website	8
Added parameters to checksum object description	43
Minor text edits, typo corrections	Multiple

Summary of Recent Changes (3.10... 3.12)

Revision	Change	Page(s)
3.11	Added trademark symbol	Front cover
3.12	Added compliance/conformance info	92

Revision List

Revision	Date	Author	Chapter	Description
2.00	2003-12-03	PeP	All	Second major release
2.01	2004-03-08	PeP	16	Corrected Control Codes
2.50	2006-04-05	PeP	All	Major update
2.51	2006-12-22	PeP	-	Misc. minor corrections & updates
2.52	2009-04-23	KeL	All	Misc. minor corrections and updates
3.00	2011-02-09	KaD	All	Misc. corrections, new template and DF1 functionality
3.01	2011-09-30	KaD	All	Misc corrections and updates, new Anybus Configuration Manager
3.10	2015-02-20	ThN	All	Misc. corrections and updates, new Doc ID
3.11	2015-03-13	ThN	Cover	Added trademark symbol
3.12	2015-03-20	ThN	C	Added compliance/conformance info

P.3 Conventions & Terminology

The following conventions are used throughout this document:

- Numbered lists provide sequential steps
- Bulleted lists provide information, not procedural steps
- The term “user” refers to the person or persons responsible for installing the Anybus Communicator in a network.
- The term “ABC” refers to the Anybus Communicator.
- Hexadecimal values are written in the format 0xNNNN, where NNNN is the hexadecimal value.
- Decimal values are represented as NNNN where NNNN is the decimal value
- As in all communication systems, the terms “input” and “output” can be ambiguous, because their meaning depend on which end of the link is being referenced. The convention in this document is that “input” and “output” are always being referenced to the master/scanner end of the link.

P.3.1 Glossary

Term	Meaning
ABC	Anybus Communicator
ACM	Anybus Configuration Manager
Broadcaster	A protocol-specific node in the configuration that handles transactions destined to all nodes.
DEV	DeviceNet
Command	A predefined transaction
Configuration	List of configured nodes with transactions on the subnetwork
Fieldbus	The higher level network to which the communicator is connected
Fieldbus Control System	Fieldbus master
Frame Object	Low level entities which are used to describe the different parts of a transaction
Monitor	A tool for debugging the Anybus Communicator and the network connections
Node	A device in the configuration which defines the communication with a node on the subnetwork
Sub-network	The network that is logically located on a subsidiary level with respect to the fieldbus, and to which the Anybus Communicator acts as a gateway
Transaction	A generic building block that is used in the subnetwork configuration and defines the data that is sent and received on the subnetwork
User	Person or persons responsible for installing the Anybus Communicator
Higher Level Network	In this case, DeviceNet
Network	
Fieldbus	

P.4 Support

For general contact information and support, please refer to the contact and support pages at www.anybus.com

1. About the Anybus Communicator for DeviceNet

The Anybus Communicator for DeviceNet acts as a gateway between virtually any serial application protocol and a DeviceNet-based network. Integration of industrial devices is enabled without loss of functionality, control and reliability, both when retro-fitting to existing equipment as well as when setting up new installations.

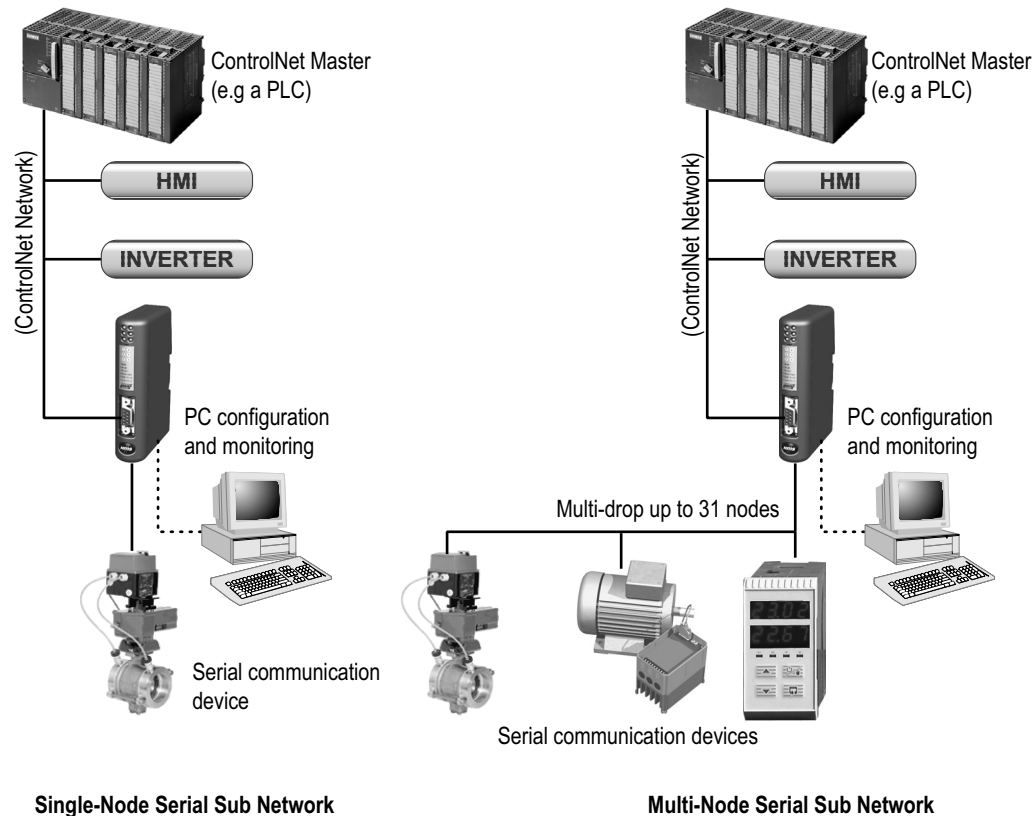

Subnetwork

The Anybus Communicator can address up to 31 nodes, and supports the following physical standards:

- RS-232
- RS-422
- RS-485

DeviceNet Interface

DeviceNet connectivity is provided through the patented Anybus technology; a proven industrial communication solution used all over the world by leading manufacturers of industrial automation products.

- Communications Adapter, profile no. 12
- Group two server
- MacID and baudrate configuration via on-board switches
- Polled, Change-of-state and Bit strobed I/O

1.1 External View

For wiring and pin assignments, see Appendix “Connector Pin Assignments” on page 87.

A: DeviceNet Connector

This connector is used to connect the Anybus Communicator to the fieldbus network.

See also...

- “DeviceNet Connector” on page 87

B: Configuration Switches

See also...

- “Configuration Switches” on page 11

C: Status LEDs

See also...

- “Status LEDs” on page 11

D: PC-connector

This connector is used to connect the gateway to a PC for configuration and monitoring purposes.

See also...

- “PC Connector” on page 88

E: Subnetwork Connector

This connector is used to connect the gateway to the serial subnetwork.

See also...

- “Subnetwork Interface” on page 89

F: Power Connector

This connector is used to apply power to the gateway.

See also...

- “Power Connector” on page 87
- “Connector Pin Assignments” on page 87

G: DIN-rail Connector

The DIN-rail mechanism connects the gateway to PE (Protective Earth).

See also...

- “Connector Pin Assignments” on page 87

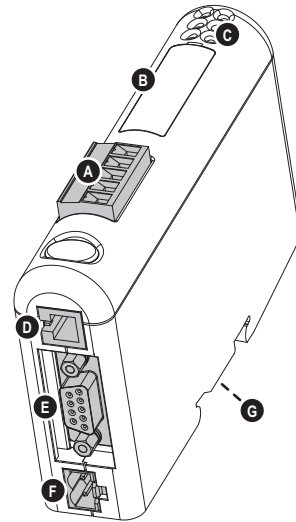

1.2 Status LEDs

#	State	Status
1 - Network Status	Off	Not powered / not online
	Green	Link OK, On line, Connected
	Green, flashing	On line, Not connected
	Red	Critical Link Failure
	Red, flashing	Connection timeout
2 - Module Status	Off	No power to device
	Green	Device Operational
	Green, flashing	Data size bigger than configured
	Red	Unrecoverable fault
	Red, flashing	Minor Fault
3 - (Not used)	-	-
4 - (Not used)	-	-
5 - Subnet Status ^a	Off	Power off
	Green, flashing	Running correctly, but one or more transaction error(s) have occurred
	Green	Running
	Red	Transaction error/timeout or subnet stopped
6 - Device Status	Off	Power off
	Alternating Red/Green	Invalid or missing configuration
	Green	Initializing
	Green, flashing	Running
	Red	Bootloader mode ^b
	Red, flashing	If the Device Status LED is flashing in a sequence starting with one or more red flashes, please note the sequence pattern and contact the HMS support department

- a. This led turns green when all transactions have been active at least once. This includes any transactions using "change of state" or "change of state on trigger". If a timeout occurs on a transaction, this led will turn red.
- b. The gateway is in bootloader mode, and firmware must be restored in order for it to work properly. Start up the Anybus Configuration Manager and connect to the Anybus Communicator. Choose Tools/Options/Module. Click "Factory Restore" to restore firmware. See "Tools" on page 24.

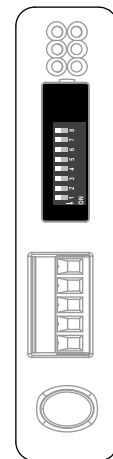
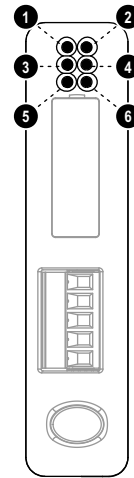

1.3 Configuration Switches

The configuration switches are used to set the DeviceNet MacID and baudrate settings.

Note that these settings cannot be changed during runtime, i.e. the Anybus Communicator requires a reset for any changes to have effect.

The switches are interpreted as follows:

Baudrate	sw. 1	sw. 2	Mac ID	sw. 3	sw. 4	sw. 5	sw. 6	sw. 7	sw. 8
125k	OFF	OFF	0	OFF	OFF	OFF	OFF	OFF	OFF
250K	OFF	ON	1	OFF	OFF	OFF	OFF	OFF	ON
500K	ON	OFF
(reserved)	ON	ON	62	ON	ON	ON	ON	ON	OFF
			63	ON	ON	ON	ON	ON	ON

1.4 Hardware Installation

Perform the following steps when physically installing the Anybus Communicator:

1. Snap the gateway on to the DIN-rail (See “External View” on page 10)

The DIN-rail mechanism works as follows:

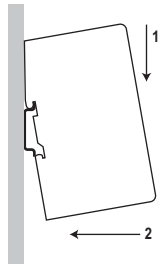

To snap the gateway *on*, first press it downwards (1) to compress the spring in the DIN-rail mechanism, then push it against the DIN-rail as to make it snap on (2)

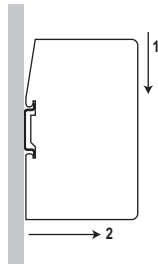

To snap the gateway *off*, push it downwards (1) and pull it out from the DIN-rail (2), as to make it snap off from the DIN-rail

2. Connect the gateway to the DeviceNet network
3. Connect the gateway to the serial subnetwork
4. Connect the gateway to a free COM-port on the PC via the PC-cable
5. Set the DeviceNet baudrate and Mac-ID using the on-board switches
6. Connect the power cable and apply power
7. Start the Anybus Configuration Manager program on the PC
(The Anybus Configuration Manager attempts to detect the serial port automatically. If not successful, select the correct port manually in the “Port”-menu)
8. Configure the ABC using the Anybus Configuration Manager and download the configuration

1.5 Software Installation

1.5.1 Anybus Configuration Manager

System requirements

- Pentium 133 MHz or higher
- 650 MB of free space on the hard drive
- 32 MB RAM
- Screen resolution 800 x 600 (16 bit color) or higher
- Microsoft Windows® 2000 / XP / Vista / 7 (32- or 64-bit)
- Internet Explorer 4.01 SP1 or newer (or any equivalent browser)

Installation

- **Anybus Communicator resource CD**
 - Insert the CD and follow the on-screen instructions.
 - If the installation does not start automatically: right-click on the CD drive icon and select “Explore” to show the contents of the CD. Locate the installation executable and double-click on it to start the installation, then follow the on-screen instructions.
- **From HMS website**
 - Download the latest version of Anybus Configuration Manager from www.anybus.com.
 - Unzip the archive on your computer and double-click on the installation executable.

1.5.2 Electronic Datasheet (EDS-file)

On DeviceNet, the characteristics of a device is stored in an ASCII data file with the suffix EDS. This file is used by DeviceNet configuration tools when setting up the network.

The latest version of this file can be obtained from the HMS website www.anybus.com.

2. Basic Operation

2.1 General

The Anybus Communicator gateway is designed to exchange data between a serial sub-network and a higher level network. Unlike most other gateway devices of similar kind, it does not have a fixed protocol for the sub-network, and can be configured to handle almost any form of serial communication.

The gateway can issue serial telegrams cyclically, on change of state, or based on trigger events issued by the control system of the higher level network (i.e. the fieldbus master or PLC). It can also monitor certain aspects of the sub-network communication and notify the higher level network when data has changed.

An essential part of the Anybus Communicator package is Anybus Configuration Manager (ACM), a Windows®-based application used to supply the gateway with a description of the sub-network protocol. No programming skills are required; instead, a visual protocol description-system is used to specify the different parts of the serial communication.

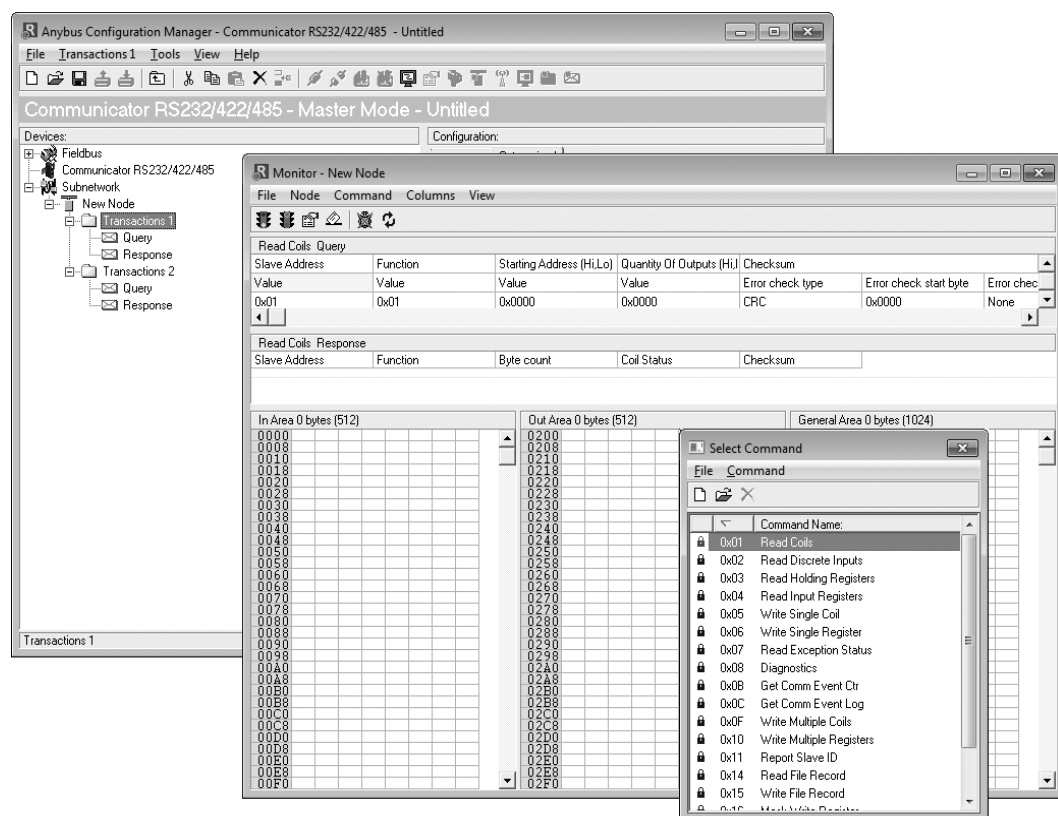

2.2 Data Exchange Model

Internally, the data exchanged on the subnetwork, and the data exchanged on the higher level network, resides in the same memory.

This means that in order to exchange data with the subnetwork, the higher level network simply reads and writes data to memory locations specified using the Anybus Configuration Manager. The very same memory locations can then be exchanged on the subnetwork.

The internal memory buffer is divided into three areas based on their function:

- **Input Data (512 bytes)**

This area can be read by the higher level network.

(how this data is represented on the higher level network will be described later in this chapter).

- **Output Data (512 bytes)**

This area can be written to by the higher level network.

(how this data is represented on the higher level network will be described later in this chapter).

- **General Data**

This area is not exchanged on the higher level network, and can be used for transfers between individual nodes on the subnetwork, or as a general “scratch pad” for data. The actual size of this area depends on the amount of data that is exchanged on the subnetwork. The gateway can handle up to 1024 bytes of General Data.

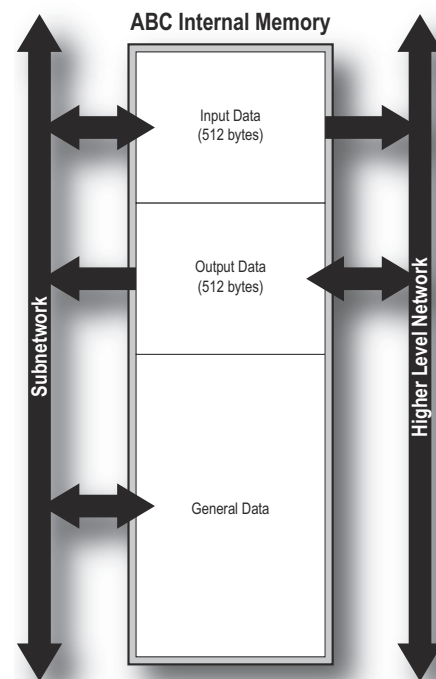

2.2.1 Memory Map

When building the subnetwork configuration using the Anybus Configuration Manager, the different areas described above are mapped to the memory locations (addresses) specified below.

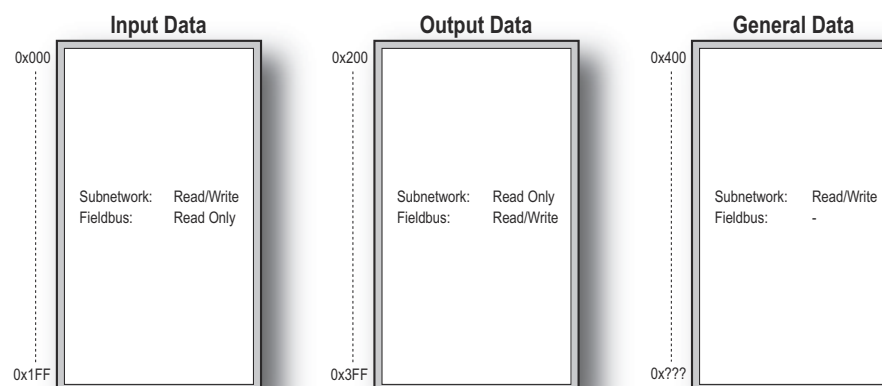

2.2.2 Data Exchange Example

In the following example, a temperature regulator on the subnetwork exchanges information with a PLC on the higher level network, via the internal memory buffers in the Anybus Communicator.

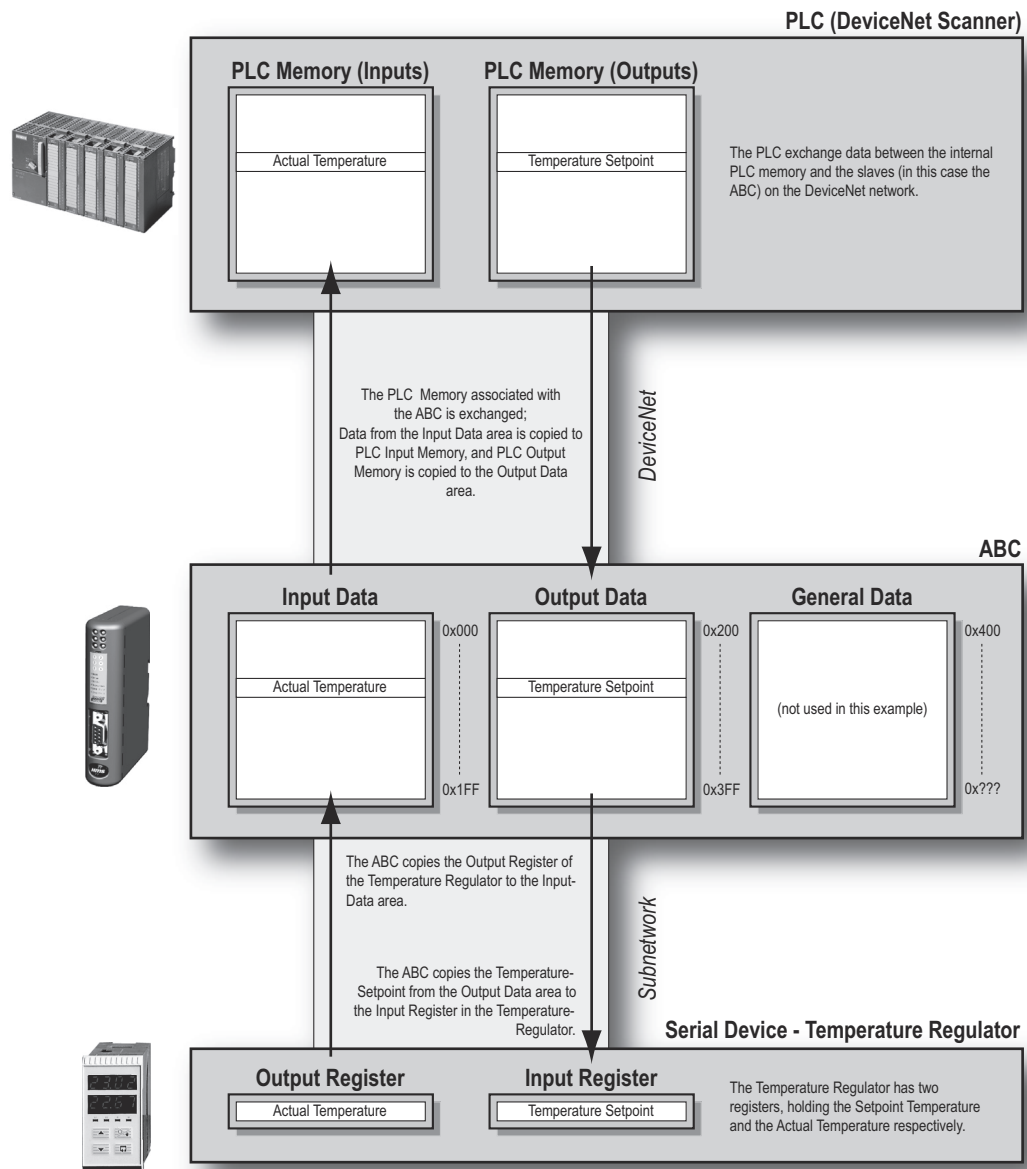

2.3 Subnetwork Protocol

2.3.1 Protocol Modes

The Anybus Communicator features three distinct modes of operation regarding the subnetwork communication, called “Master Mode”, “DF1 Master Mode” and “Generic Data Mode”. Note that the protocol mode only specifies the basic communication model, not the actual subnetwork protocol.

- **Master Mode**

In this mode, the gateway acts as a master on the subnetwork, and the serial communication takes place in a query-response fashion. The nodes on the network are not permitted to issue messages unless they have been addressed by the gateway first.

For more information about this mode, see “Master Mode” on page 18.

- **DF1 Master Mode**

In this mode, the gateway acts as a master on the subnetwork, using the DF1 protocol. The serial communication takes place in a query-response fashion. For more information about this mode, see “DF1 Protocol Mode” on page 49.

- **Generic Data Mode**

In this mode, there is no master-slave relationship between the subnetwork nodes and the gateway; any node on the subnetwork, including the gateway, may spontaneously produce or consume messages.

For more information about this mode, see “Generic Data Mode” on page 19.

2.3.2 Protocol Building Blocks

The following building blocks are used in Anybus Configuration Manager to describe the subnetwork communication. How these blocks apply to the two protocol modes will be described later in this document.

- **Node**

A node represents a single device on the subnetwork. Each node can be associated with a number of transactions, see below.

- **Transaction**

A “transaction” represents a complete serial telegram, and consists of a number of frame objects (see below). Each transaction is associated with a set of parameters controlling how and when to use it on the subnetwork.

- **Commands**

A “command” is simply a predefined transaction stored in a list in the Anybus Configuration Manager. This simplifies common operations by allowing transactions to be stored and reused.

- **Frame Object**

“Frame objects” are low level entities used to compose a transaction (see above). A frame object can represent a fixed value (a constant), a range of values (limit objects), a block of data or a calculated checksum.

2.3.3 Master Mode

In this mode, the communication is based on a query-response scheme; when the Anybus Communicator issues a query on the subnetwork, the addressed node is expected to issue a response to that query. Nodes are not permitted issue responses spontaneously, i.e. without first receiving a query.

There is one exception to this rule; the broadcaster. Most protocols offer some way of broadcasting messages to all nodes on the network, without expecting them to respond to the broadcasted message. This is also reflected in the gateway, which features a dedicated broadcaster node.

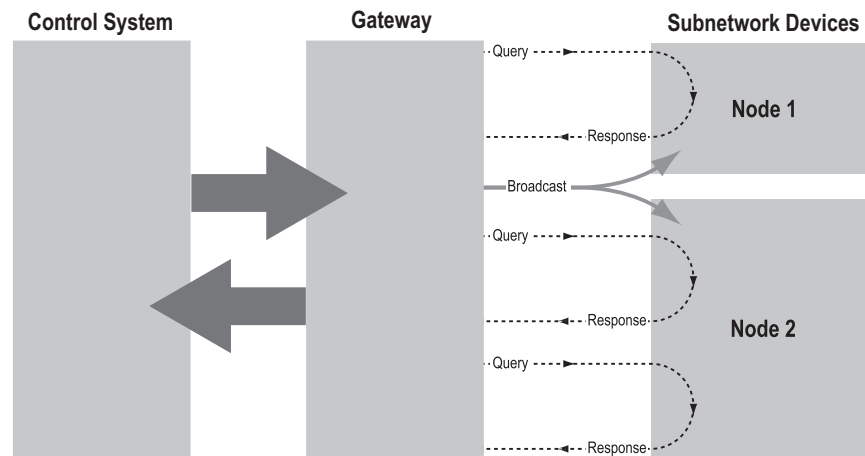

In Master Mode, Anybus Configuration Manager comes preloaded with most commonly used Modbus RTU commands, which can conveniently be reached by right-clicking on a node in the Anybus Configuration Manager and selecting “Insert New Command”. Note however that this does not in any way prevent other protocols based on the same query-response message-scheme to be implemented.

2.3.4 Generic Data Mode

In this mode, there is no master-slave relationship between the nodes on the subnetwork and the gateway. Any node, including the gateway, may spontaneously produce or consume a message. Nodes do not have to respond to messages, nor do they have to wait for a query in order to send one.

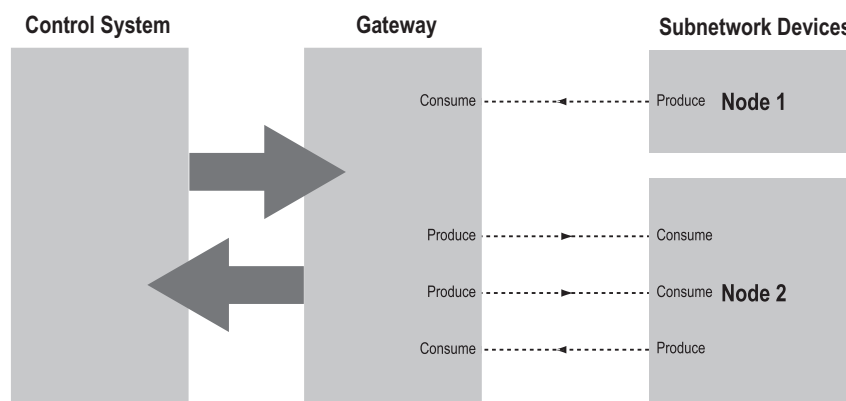

In the figure above, the gateway “consumes” data that is “produced” by a node on the subnetwork. This “consumed” data can then be accessed from the higher level network. This also works the other way around; the data received from the higher level network is used to “produce” a message on the subnetwork to be “consumed” by a node.

2.3.5 DF1 Master Mode

Please refer to “DF1 Protocol Mode” on page 49.

2.4 Data Representation on DeviceNet

2.4.1 General

DeviceNet is based on the Control and Information protocol (CIP) which is also the application layer for ControlNet and EtherNet/IP.

The input and output data is accessed using I/O connections or explicit messages towards the Assembly Object and the Parameter Input/Output Mapping Objects.

See also...

- “CIP Object Implementation” on page 70

2.4.2 Data Types

The input and output data holds two types of data; I/O Data and parameter data. I/O Data is exchanged on change of value, and can be accessed using I/O connections towards the Assembly Object.

Parameter data can be accessed acyclically via the Parameter Input- and Output Mapping Objects. Note however that each instance attribute within these objects must be created manually using the Anybus Configuration Manager. For more information see “Parameter Data Initialization (Explicit Data)” on page 82.

See also...

- “Assembly Object, Class 04h” on page 74
- “Parameter Data Input Mapping Object, Class B0h” on page 79
- “Parameter Data Output Mapping Object, Class B1h” on page 80
- “Fieldbus Settings” on page 27

2.4.3 Memory Layout

The I/O sizes are specified using the Anybus Configuration Manager and correlates to gateway memory as follows:

Example:

In this example, the I/O Sizes for the gateway have been set to the following values:

IO Size In= 256 bytes(0x0100)

IO Size Out= 128 bytes(0x0080)

Resulting memory layout:

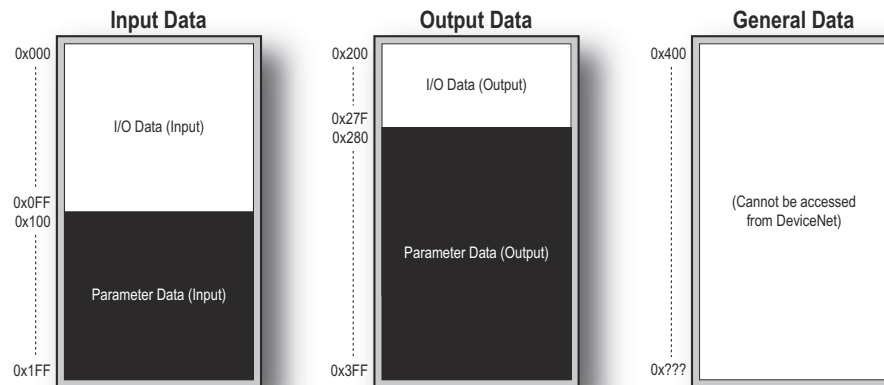

3. Navigating ACM

3.1 Main Window

The main window in ACM can be divided into 4 sections as follows:

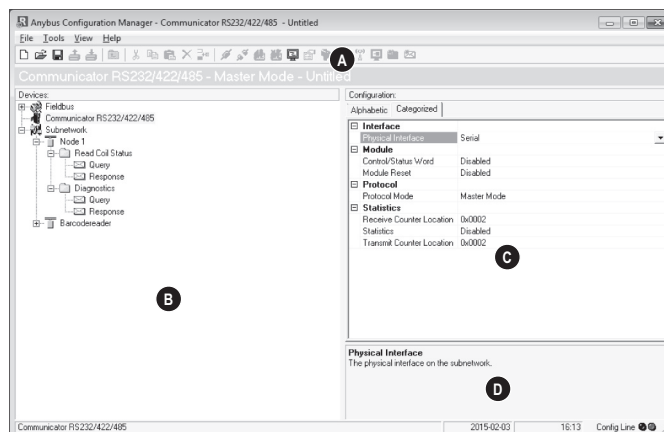

- **A: Drop-down Menus & Tool Bar**

The second drop-down menu from the left will change depending on the current context. The Tool Bar provides quick access to the most frequently used functions.

- **B: Navigation Section**

This section is the main tool for selecting and altering different levels of the sub-network configuration.

Entries preceded by a “+” holds further configuration parameters or “sub menus”. To gain access to these parameters, the entry must be expanded by clicking “+”.

There are three main levels in the navigation window, namely Fieldbus, Communicator RS232/422/485, and Subnetwork.

Right-clicking on entries in this section brings out additional selections related to that particular entry.

- **C: Parameter Section**

This section holds a list of parameters or options related to the currently selected entry in the Navigation Section.

The parameter value may be specified either using a selection box or manually, depending on the parameter itself. Values can be specified in decimal form (e.g. “42”), or in hexadecimal format (e.g. “0x2A”).

- **D: Information Section**

This section holds information related to the currently selected parameter.

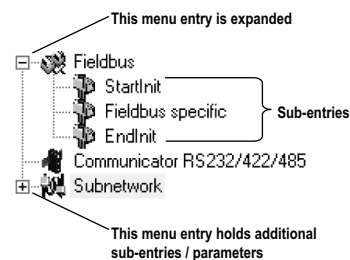

3.1.1 Drop-down Menus

File

- **New**
Create a new configuration.
See also “Configuration Wizards” on page 64.
- **Open...**
Open a previously created configuration.
- **Save**
Save the current configuration.
- **Save As...**
Save the current configuration under a new name.
- **Print...**
Send details about the current configuration to a printer.
- **Properties...**
Set the name and (optional) passwords for the configuration.

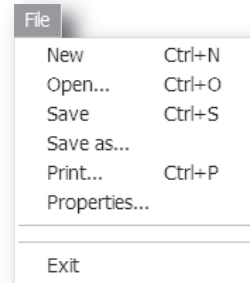

Item	Description
Select a Name for the Configuration	Enter a descriptive name for the new configuration
Enable Password	Enables password protection
Download Password(6)	Set passwords for downloading and uploading the configuration (max. 6 characters)
Upload Password(6)	

CAUTION: Always keep a copy of the password in a safe place. A lost password cannot be retrieved!

- **Exit**
Close ACM.



Tools

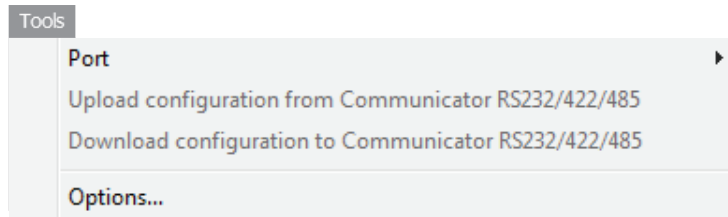

- **Port**
Select the COM-port used for the configuration of the gateway.
- **Upload configuration from Communicator RS232/422/485**
Upload the configuration from the gateway to ACM.
- **Download configuration to Communicator RS232/422/485**
Download the current configuration to the gateway.
- **Start Logging**
Start the Data Logger (see “Data Logger” on page 61).
Note that when the Data Logger is active, this menu entry is changed to “Stop Logging”.
- **Options**

This will open the following window:

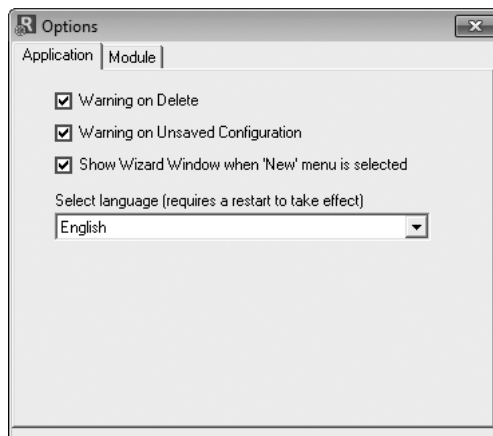

Item	Description
Warning on Delete	A confirmation dialog is displayed each time something is deleted.
Warning on Unsaved Configuration	A confirmation dialog is displayed when closing ACM with unsaved data.
Show Wizard when “New” menu is selected	The Wizard is displayed each time a new configuration is created.
Select language	Selects which language to use. The new setting will be active the next time the program is launched.

Selecting the “Module” tab will reveal additional properties:

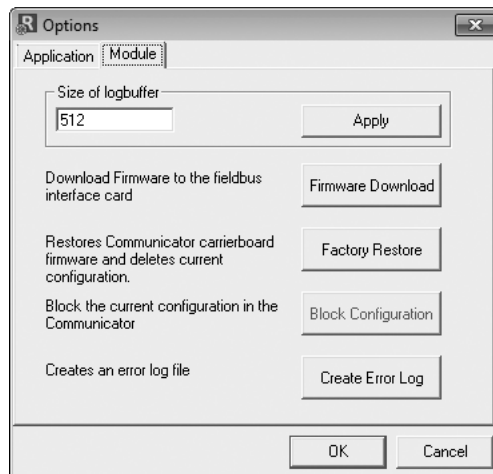

Item	Description
Size of logbuffer	By default, the Data Logger can log up to 512 entries in each direction. If necessary, it is possible to specify a different number of entries (valid settings range from 1...512). Click “Apply” to validate the new settings. See also “Data Logger” on page 61.
Firmware Download	Download firmware to the embedded fieldbus interface. Warning: Use with caution.
Factory Restore	Restores the gateway firmware to the original state (does not affect the embedded fieldbus interface).
Block Configuration	When selected, the downloaded configuration will not be executed by the gateway. Warning: Use with caution.
Create Error log	Creates an error log file

View

- **Toolbar**

Enables/disables the toolbar icons at the top of the main window.

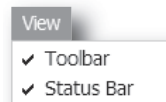

- **Status Bar**

Enables/disables the status bar at the bottom of the main window.

Help

- **Contents/Search For Help On...**

Opens a built-in browser window with a link to the Anybus support website.

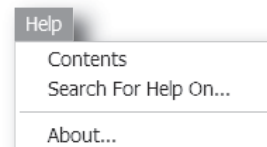



- **About...**



Displays general information about the gateway and the current version of ACM.

3.1.2 Toolbar Icons





The toolbar features icons for the most commonly used functions.

- **New, Open & Save**
See “File” on page 23.





- **Upload from ABC & Download to ABC**
See “Tools” on page 24.





- **Up one Level**
Clicking on this icon will move the selection in the navigation section.



- **Cut, Copy, Paste, Delete, Insert**
These icons are used for common editing functions in the navigation section.







- **Connect**
Clicking on this icon will cause ACM to attempt to connect to the gateway.



- **Disconnect**
Clicking on this icon will cause ACM to disconnect from the gateway.



- **Start Logging & Stop Logging**
See “Tools” on page 24 & “Data Logger” on page 61.



- **Sub-network Monitor**
Clicking on this icon will launch the sub-network Monitor (see “Sub-network Monitor” on page 56).



- **Add Command**
This icon is used to add commands to the currently selected node.

- **Add Mailbox**
(Advanced functionality, see “Mailbox Editor” on page 81)

- **Add Node & Add Broadcaster**
These icons are used to add nodes to the configuration.



- **Node Monitor**
Clicking on this icon will launch the Node Monitor (see “Node Monitor” on page 57)

- **Add Transaction(s)**
These icons are used to add transactions to the currently selected node.

4. Basic Settings

4.1 Fieldbus Settings

(Select “Fieldbus” in the Navigation Section to gain access to the parameters described in this section).



General

During start-up the fieldbus interface of the Anybus Communicator is initialized to fit the configuration created in the Anybus Configuration Manager. Optionally, some initialization parameters can be set manually to provide better control over how the data shall be treated by the gateway.

Fieldbus Type

The Anybus Configuration Manager supports a wide range of networking systems. Make sure that this parameter is set to “DeviceNet”.

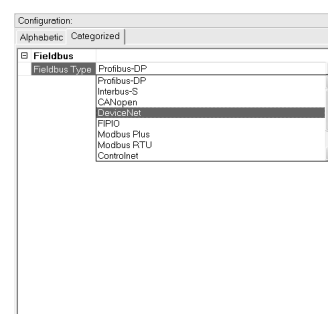

Fieldbus Type

IO Sizes

These parameters specify how data from the internal memory buffer shall be exchanged on DeviceNet. This can either be handled automatically based on the subnetwork configuration, or specified manually.

- **Automatic**
All data will be represented as I/O Data on DeviceNet.
- **User defined**
Additional parameter properties appear; “IO Size In” and “IO Size Out”. The specified amount, starting at address 0x0000 of the respective memory buffers, will be reserved for and represented as I/O Data. The remainder will be reserved for parameter data.

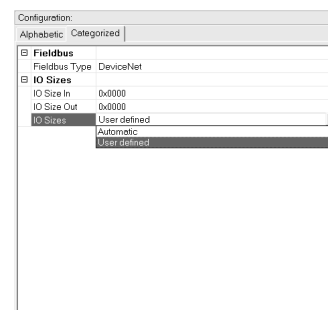

IO Sizes

See also...

- “Data Representation on DeviceNet” on page 20
- “Assembly Object, Class 04h” on page 74
- “Parameter Data Input Mapping Object, Class B0h” on page 79
- “Parameter Data Output Mapping Object, Class B1h” on page 80

4.2 Communicator Parameters

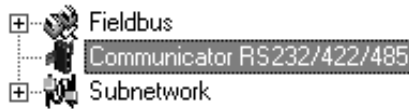

Interface

Only serial communication is currently supported.

Control/Status Word

See “Control and Status Registers” on page 65.

Value	Description
Enabled	Enable the Control and Status Registers. The “Data Valid”-bit in the Control Register must be set to start the sub-network communication.
Enabled but no startup lock	This setting is similar to “Enabled”, except that the control system is not required to set the “Data Valid”-bit to start the sub-network communication.
Disabled	This setting completely disables the Control and Status Registers.

Module Reset

This parameter specifies how the gateway will behave in the event of a fatal error.

Value	Description
Enabled	The gateway will be restarted, and no error will be indicated to the user.
Disabled	The gateway will halt and indicate an error.

Protocol Mode

This parameter specifies which protocol mode to use for the sub-network. See “Protocol Modes” on page 17.

Value	Description
Generic Data Mode	This mode is primarily intended for Produce & Consume-based protocols, where there are no Master-Slave relationship between the gateway and the nodes on the sub-network.
Master Mode	This mode is intended for “Query & Response”-based protocols, where a single Master exchanges data with a number of Slaves.
DF1	This mode is intended for the DF1 protocol. The Anybus Communicator can only be configured as a Master with half-duplex communication. Note: This is the only mode available if you intend to configure an ABC module for DF1.

Statistics

The Transmit- and Receive Counters indicate how many transactions that have successfully been exchanged on the sub-network. This feature is primarily intended for debugging purposes.

- **Receive Counter Location**
Specifies the location of the Receive Counter in the internal memory buffer.
- **Transmit Counter Location**
Specifies the location of the Transmit Counter in the internal memory buffer.
- **Statistics**
Enables/disables the Receive and Transmit Counters.

4.1 Sub-network Parameters



Communication

These parameters specify the actual communication settings used for the sub-network.

Parameter	Description	Master Mode and Generic Mode
Bitrate (bits/s)	Selects the bit rate	1200 2400 4800 9600 19200 35700 38400 57600
Data bits	Selects the number of data bits	7, 8
Parity	Selects the parity mode	None, Odd, Even
Physical standard	Selects the physical interface type	RS232, RS422, RS485
Stop bits	Number of stop bits.	1, 2

Start- and End Character

Note: These parameters are only available in Generic Data Mode.

Start and end characters are used to indicate the beginning and end of a serial message. For example, a message may be initiated with <ESC> and terminated with <LF>. In this case, the Start character would be 0x1B (ASCII code for <ESC>) and the End character 0x0A (ASCII code for <LF>)

Parameter	Description	Valid settings
End character value	End character for the message, ASCII	0x00–0xFF
Use End character	Determines if the End character shall be used or not	Enable / Disable
Start character value	Start character for the message, ASCII	0x00–0xFF
Use Start character	Determines if the Start character shall be used or not	Enable / Disable

Timing (Message Delimiter)

The parameters in this category differs slightly between the different protocol modes.

- **Master Mode**

The Message Delimiter specifies the time that separates two messages in steps of 10 ms. If set to 0 (zero), the gateway will use the standard Modbus delimiter of 3.5 characters (the actual number of ms will be calculated automatically based on the currently used communication settings).

- **Generic Data Mode**

The Message Delimiter specifies the time that separates two messages in steps of 10 μ s.

5. Nodes

5.1 General

In ACM, a node represents a single device on the network. Although the gateway does not feature a scan list in the traditional sense, all nodes and their transactions will be processed in the order they were defined in ACM.

The maximum number of nodes that can be created in ACM is 31.

5.2 Adding & Managing Nodes

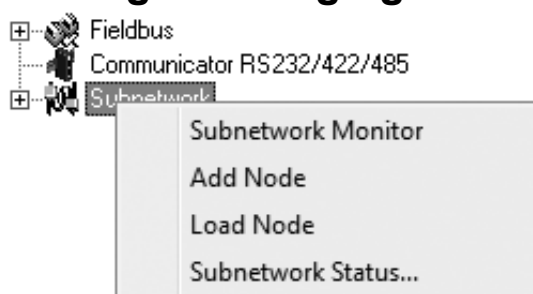

Function	Description
Paste	Paste a node from the clipboard
Subnetwork Monitor	Launch the subnet monitor (see "Sub-network Monitor" on page 56)
Add Node	Add a node to the configuration
Add Broadcaster ^a	Add a broadcaster node to the configuration
Load Node	Add a previously saved node
Subnetwork Status...	View diagnostic information about the sub-network

a. This function is only available in Master Mode.

5.3 Node Parameters

5.3.1 Master Mode and Generic Data Mode



To gain access to the parameters described in this section, select a node in the Navigation Section.

Parameter	Description
Slave Address	The value entered here may be used to set the node address in certain commands. For more information, see "The Command Editor" on page 46.

6. Transactions

6.1 General

As mentioned previously, transactions are representations of the actual serial telegrams exchanged on the serial sub-network. Although the gateway does not feature a scan list in the traditional sense, all nodes and their transactions will be processed in the order they were defined in ACM.

Transactions are handled slightly differently in the three protocol modes:

- **Master Mode**

For regular nodes, transactions always come in pairs; a query and a response. The query is issued by the gateway, while responses are issued by the slaves on the sub-network. The Broadcaster can only send transactions.

- **Generic Data Mode**

Transactions can be added as desired for both directions. Transactions sent to the sub-network are called “Transaction Produce”, and transactions issued by other nodes are called “Transaction Consume”.

- **DF1 Master Mode**

Please refer to “DF1 Protocol Mode” on page 49.

Theoretically, the gateway supports up to 150 transactions. The actual number may however be less depending on the memory requirements of the defined transactions.

6.2 Adding & Managing Transactions

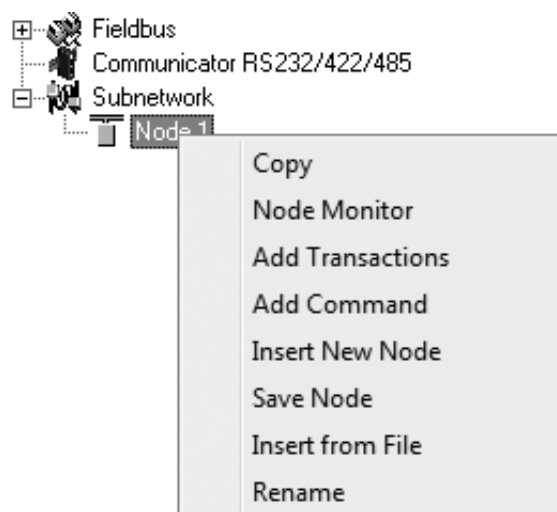

Function	Description
Copy	Copy a node to the clipboard
Delete ^a	Delete a node
Node Monitor	Launch the node monitor (see "Node Monitor" on page 57)
Add Transaction(s) ^b	On regular nodes, this adds a Query and a Response. The two transactions will be grouped in order to increase readability. On the Broadcaster, a single transaction will be added.
Add Transaction Consume ^c	Add a "Consume"-transaction
Add transaction Produce ^c	Add a "Produce"-transaction
Add Command	Add predefined transactions to the node
Insert New Node	Insert a new node above the currently selected one
Save Node	Save the selected node
Insert from File	Insert a previously saved node above the currently selected node
Rename	To increase readability, each node can be given a unique name using this function

a. Only available if more than one node exists

b. Only available in Master Mode

c. Only available in Generic Data Mode

6.3 Transaction Parameters (Master Mode)

6.3.1 Parameters (Query & Broadcast)

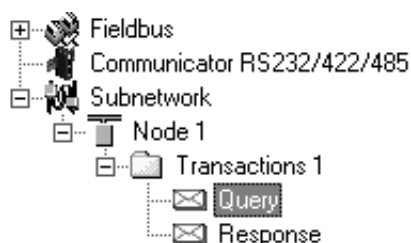

Alphabetic	Categorized
<input type="checkbox"/> General	
Offline options for fieldbus	Clear
Offline options for sub-network	Clear
Update mode	Cyclically
<input type="checkbox"/> Timing	
Minimum time between broadcasts (10ms)	100
Reconnect time (10ms)	1000
Retries	3
Timeout time (10ms)	100
Update time (10ms)	100
<input type="checkbox"/> Trigger	
Trigger byte address	0x05FF

Parameter	Description
Minimum time between broadcasts (10 ms)	This parameter specifies how long the gateway shall wait after transmitting a broadcast transaction before processing the next entry in the scanlist. The value should be set high enough to allow the slave devices time to finish the handling of the broadcast. The entered value is multiplied by 10. An entered value of 5 will result in 50 ms. Note: This setting is only relevant for the Broadcaster node.
Offline options for fieldbus	This parameter specifies the action to take for this transaction if the higher level network goes offline. This affects the data that is sent to the sub-network. <ul style="list-style-type: none"> • Clear - The data destined for the slave-devices is cleared (set to zero) • Freeze - The data destined for the slave-device is frozen • NoScanning -The updating of the sub-network is stopped
Offline options for sub-network	This parameter specifies the action to take for this transaction if the sub-network goes offline. This affects the data that is reported to the control system. <ul style="list-style-type: none"> • Clear - Data is cleared (0) on the higher level network if the sub-network goes offline • Freeze - Data is frozen on the higher level network if the sub-network goes offline
Reconnect time (10 ms)	This parameter specifies how long the gateway shall wait before attempting to reconnect a disconnected node. A node will be disconnected in case the maximum number of retries (below) has been reached. The entered value is multiplied by 10. An entered value of 5 will result in 50 ms. Note: This setting is not relevant for the Broadcaster node.
Retries	This parameter specifies how many times a timeout may occur in sequence before the node is disconnected.
Timeout time (10 ms)	This parameter specifies how long the gateway will wait for a response from a node. If this time is exceeded, the gateway will retransmit the Query until the maximum number of retries (see above) has been reached. The entered value is multiplied by 10. An entered value of 5 will result in 50 ms.
Trigger byte address	This parameter specifies the location of the trigger byte in internal memory (only relevant when "Update mode" is set to "Change of state on trigger"). Valid settings range from 0x200 to 0x3FF and 0x400 to 0xFF

Parameter	Description
Update mode	<p>This parameter is used to specify when the transaction shall be sent to the slave:</p> <ul style="list-style-type: none"> • Cyclically The transaction is issued cyclically at the interval specified in the "Update time" parameter. • On data change The data area is polled for changes at the time interval defined by Update time. A transaction is issued when a change in data is detected. • Single shot The Query is issued once at start up. • Change of state on trigger The Query is issued when the trigger byte value has changed. This feature enables the control system to notify the gateway when to issue a particular Query. To use this feature correctly, the control system must first update the data area associated with the Query/transaction, then increase the trigger byte by one. The location of the trigger byte is specified by the "Trigger byte address" parameter. The trigger byte is checked at the interval specified in the "Update time" parameter.
Update time (10 ms)	<p>This parameter specifies how often the transaction will be issued in steps of 10 ms (relevant only when "Update mode" is set to "Cyclically", "On data change" or "Change of state on trigger").</p> <p>The entered value is multiplied by 10. An entered value of 5 will result in 50 ms.</p>

6.3.2 Parameters (Response)



Alphabetic		Categorized
[-] Trigger		
Trigger byte	Disabled	
Trigger byte address	0x05FF	

Parameter	Description
Trigger byte	<p>This parameter is used to enable/disable the trigger functionality for the response. If enabled, the gateway will increase the trigger byte by one when the gateway receives new data from the sub-network. This can be used to notify the control system of the updated data.</p> <p>The location of the trigger byte is specified by the "Trigger byte address" parameter below.</p>
Trigger byte address	<p>This parameter specifies the location of the trigger byte in the internal memory buffer.</p> <p>Valid settings range from 0x000 to 0x1FF and 0x400 to 0xFFF</p>

6.4 Transaction Parameters (Generic Data Mode)

6.4.1 Produce Transactions



Alphabetic	Categorized
General	
Offline options for fieldbus	Clear
Update mode	Cyclically
Timing	
Update time (10ms)	100
Trigger	
Trigger byte address	0x05FF

Parameter	Description
Offline options for fieldbus	<p>This parameter specifies the action to take for this transaction if the higher level network goes offline. This affects the data that is sent to the sub-network.</p> <ul style="list-style-type: none"> • Clear Data is cleared (0) on the sub-network if the higher level network goes offline • Freeze Data is frozen on the sub-network if the higher level network goes offline • NoScanning Stop subnet scanning for this transaction if the higher level network goes offline
Update mode	<p>The update mode for the transaction:</p> <ul style="list-style-type: none"> • Cyclically The transaction is sent cyclically at the interval specified in "Update Time". • On data change The data area is polled for changes at the time interval defined by Update time. A transaction is issued when a change in data is detected. • Single shot The transaction is sent once at startup. • Change of state on trigger The transaction is sent when the trigger byte has changed. This feature enables the control system to notify the gateway when to issue a particular transaction. To use this feature correctly, the control system must first update the data area associated with the transaction, then increase the trigger byte by one. The location of the trigger byte is specified by the "Trigger byte address" parameter. The trigger byte is checked at the interval specified in the "Update time" parameter.
Update time (10 ms)	<p>This parameter specifies how often the transaction will be issued in steps of 10ms (relevant only when "Update mode" is set to "Cyclically", "On data change" or "Change of state on trigger").</p> <p>The entered value is multiplied by 10. An entered value of 5 will result in 50 ms.</p>

Parameter	Description
Trigger byte address	<p>This parameter specifies location of the trigger byte in the internal memory buffer.</p> <p>If “Update mode” is set to “Change of state on trigger”, the memory location specified by this parameter is monitored by the gateway. Whenever the trigger byte is updated, the gateway will produce the transaction on the sub-network.</p> <p>This way, the control system can instruct the gateway to produce a specific transaction on the sub-network by updating the corresponding trigger byte.</p> <p>The trigger byte should be incremented by one for each activation. Please note that the trigger byte address must be unique to each transaction. It can not be shared by two or more transactions.</p> <p>Note: This parameter has no effect unless the “Update mode” parameter is set to “Change of state on trigger”.</p> <p>Valid settings range from 0x200 to 0x3FF and 0x400 to 0xFF</p>

6.4.2 Consume Transactions



Alphabetic		Categorized
General		
Offline options for sub-network		Clear
Timing		
Offline timeout time (10ms)		100
Trigger		
Trigger byte		Disabled
Trigger byte address		0x05FF

Parameter	Description
Offline options for sub-network	<p>This parameter specifies the action to take for this transaction if the sub-network goes offline. This affects the data that is sent to the higher level network.</p> <ul style="list-style-type: none"> • Clear Data is cleared (0) on the higher level network if the sub-network goes offline • Freeze Data is frozen on the higher level network if the sub-network goes offline
Offline timeout time (10 ms)	<p>This parameter specifies the maximum allowed time between two incoming messages in steps of 10ms. If this time is exceeded, the sub-network is considered to be offline. A value of 0 disables this feature, i.e. the sub-network can never go offline.</p> <p>The entered value is multiplied by 10. An entered value of 5 will result in 50 ms.</p>
Trigger byte	<ul style="list-style-type: none"> • Enable Enables the trigger byte. The location of the trigger byte must be specified in “Trigger byte address”. The trigger byte value will be increased each time a valid transaction has been consumed by the gateway. The trigger byte will also be increased if the offline option is set to “Clear” and the offline timeout time value is reached. This feature enables the control system to be notified each time new data has been consumed on the sub-network. • Disable Disables the trigger byte functionality.
Trigger byte address	<p>This parameter specifies the location of the trigger byte in the internal memory buffer.</p> <p>Valid settings range from 0x000 to 0x1FF and 0x400 to 0xFF.</p> <p>Please note that the trigger byte address must be unique to each transaction. It can not be shared by two or more transactions.</p>

6.5 Transaction Editor

The Transaction Editor can be used to edit the individual frame objects of a transaction. The same settings are also available in the parameter section of the main window, however the Transaction Editor presents the frame objects in a more visual manner.

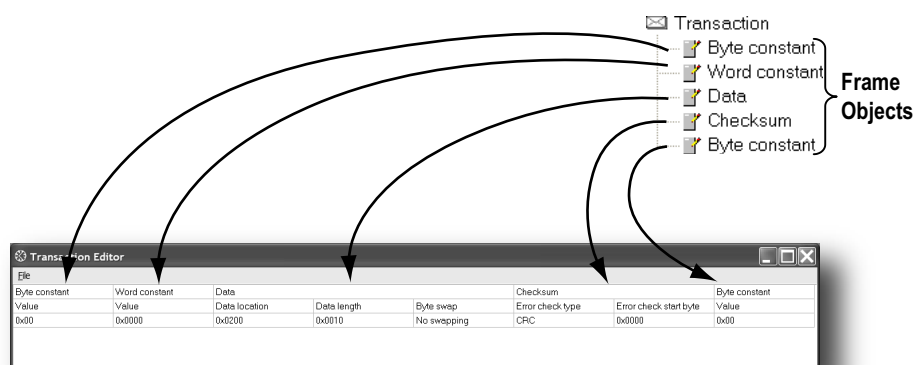

To edit the value of a parameter, click on it and enter a new value using the keyboard. When editing transactions which are based on predefined commands, certain parts of the transaction may not be editable.

The File menu features the following entries:

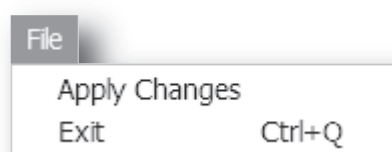

- **Apply Changes**
This will save any changes and exit to the main window.
- **Exit**
Exit without saving.

Example:

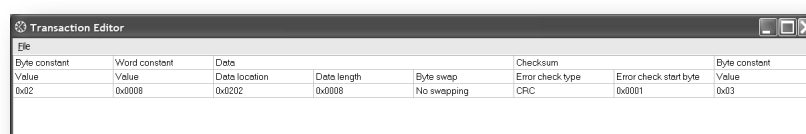

The transaction created in this example are built up as follows:

The first byte holds the STX (0x02) followed by two bytes specifying the length of the data field (in this case 8). The next 8 bytes are data and since this is a “query”-transaction, the data is to be fetched from the Output Area which starts at address location 0x202. No swapping will be performed on the data. This is followed by a two-byte checksum. The checksum calculation starts with the second byte in the transaction.

The transaction ends with a byte constant, the ETX (0x03).

7. Frame Objects

7.1 General

Each transaction consists of Frame Objects which makes up the serial telegram frame. Each Frame Object specifies how the gateway shall interpret or generate a particular part of the telegram.

There are 5 types of frame objects, which are described in detail later in this chapter:

- Constant Objects
- Limit Objects
- Data Objects
- Variable Data Objects
- Checksum Objects

Example:

The following Transaction consists of several frame objects; three constants, a data object, and a checksum object.

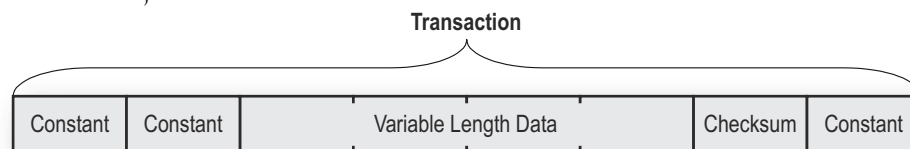

7.2 Adding and Editing Frame Objects

To add a frame object to a Transaction, right-click on the Transaction in the Navigation Section and select one of the entries in the menu that appears.

The entry called "Transaction Editor" will launch the Transaction Editor, which is used to edit transactions and frame objects in a more visual manner. For more information, see "Transaction Editor" on page 37.

To edit parameters associated with a particular frame object, select the frame object in the Navigation Section. The settings for that frame object will be displayed in the Parameter Section.

It is also possible to edit the frame objects in a transaction in a more visual manner using the Transaction Editor, see "Transaction Editor" on page 37.

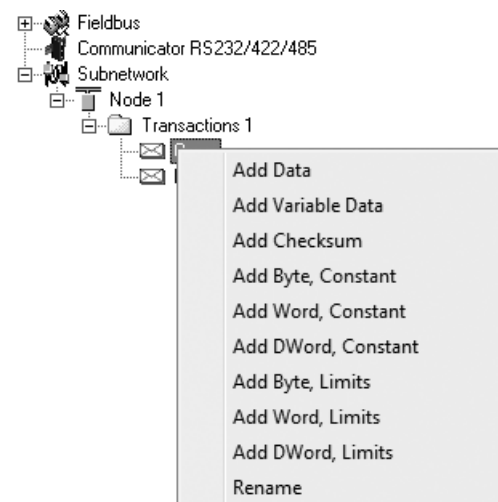

7.3 Constant Objects (Byte, Word, Dword)

Constant Objects have a fixed value and come in three sizes:

- **Byte**
8 bits
- **Word**
16 bits
- **Dword**
32 bits

Constants are handled differently depending on the direction of the transaction:

- **Produce/Query Transactions**
The gateway will send the value as it is without processing it.
- **Consume/Response Transactions**
The gateway will check if the received byte/word/dword matches the specified value. If not, the message will be discarded.

To set the value of the object, select it in the Navigation Section and enter the desired value in the Parameter section.

Parameter	Description
Value	Constant value

7.4 Limit Objects (Byte, Word, Dword)

Limit Objects have a fixed range and come in three sizes:

- **Byte**
8 bits
- **Word**
16 bits
- **Dword**
32 bits

Limit Objects are handled differently depending on the direction of the transaction:

- **Produce/Query Transactions**
This object shall not be used for such transactions (value will be undefined).
- **Consume/Response Transactions**
The gateway will check if the received byte/word/dword fits inside the specified boundaries. If not, the message will be discarded.

There are 3 types of interval objects:

- **Byte**
8 bit interval
- **Word**
16 bit interval
- **Dword**
32 bit interval

To set the range of the object, select it in the Navigation Section and enter the desired range in the Parameter section as follows:

Parameter	Description
Maximum Value	This is the largest allowed value for the range. Range:0x00 to 0xFFh(byte) 0x0000 to 0xFFFFh(word) 0x00000000 to 0xFFFFFFFFh(dword) Note: The value must be larger than the Minimum Value.
Minimum Value	This is the smallest allowed value for the range. Range:0x00 to 0xFEh(byte) 0x0000 to 0xFFEh(word) 0x00000000 to 0xFFFFFEEh(dword) Note: The value must be less than the Maximum Value.

7.5 Data Object

Data Objects are used to represent raw data as follows:

- **Produce/Query Transactions**
The specified data block is forwarded from the higher level network to the sub-network.
- **Consume/Response Transactions**
The specified data block is forwarded from the sub-network to the higher level network.

To specify the properties of the object, select it in the Navigation Section and enter the desired settings in the Parameter section as follows:

Parameter	Description
Byte Swapping	<ul style="list-style-type: none"> • No Swapping No swapping is performed on the data • Swap 2 bytes A, B, C, D becomes B, A, D, C • Swap 4 bytes A, B, C, D becomes D, C, B, A
Data Length	The length of the data block, in bytes. In case of a Response or Consume transaction, incoming messages where the data size differs from the value specified here will be discarded. Maximum data length allowed for one frame is 300 bytes.
Data Location	The location of the data block in the internal memory buffer.

7.6 Variable Data Object

Note: Only one Variable Data Object is permitted for each transaction.

This object is similar to the Data Object, except that it has no predefined length. Instead, an End or Length-character specifies the size of the data block as follows:

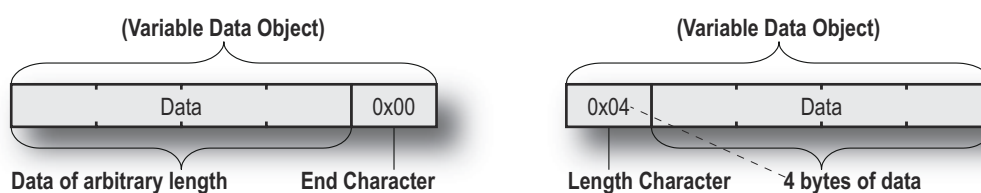

- **Produce/Query Transactions**
The specified data block will be forwarded from the higher level network to the sub-network. The control system must supply an End or Length character in order for the gateway to know the size of the data block.
The End- or Length-character itself may either be forwarded to the sub-network or discarded.
- **Consume/Response Transactions**
The specified data block is forwarded from the sub-network to the higher level network. The End- or Length-character will be generated by the gateway automatically (if applicable).
The End- or Length-character itself may either be forwarded to the higher level network or discarded.

To specify the properties of the object, select it in the Navigation Section enter the desired settings in the Parameter section as follows:

Parameter	Description
Byte Swapping	<ul style="list-style-type: none"> • No Swapping No swapping will be performed on the data • Swap 2 bytes A, B, C, D becomes B, A, D, C • Swap 4 bytes A, B, C, D becomes D, C, B, A
Fill unused bytes	<ul style="list-style-type: none"> • Enabled^a Fill unused data with the value specified in "Filler byte". • Disabled Don't fill
Filler byte	Filler byte value. Only used if "Fill unused bytes" has been enabled.
Data Location	The offset in the internal memory buffer where the data shall be read from / written to
Object Delimiter (Produce/Query)	<ul style="list-style-type: none"> • Length Character Length character visible in internal memory buffer but <i>not</i> sent out on the sub-network • Length Character Visible Length character visible in internal memory buffer <i>and</i> sent out on the sub-network • End Character End character visible in internal memory buffer but <i>not</i> sent out on the sub-network • End Character Visible End character visible in the internal memory buffer <i>and</i> sent out on the sub-network • No Character No end- or length-character generated in the internal memory buffer
Object Delimiter (Consume/Response)	<ul style="list-style-type: none"> • Length Character Length character visible in internal memory buffer but <i>not</i> received from the sub-network • Length Character Visible Length character visible in internal memory buffer <i>and</i> received from the sub-network • End Character End character visible in internal memory buffer but <i>not</i> received from the sub-network • End Character Visible End character visible in the internal memory buffer <i>and</i> received from the sub-network • No Character No end or length characters included in the received string or generated in the internal memory buffer
End Character Value	End Character value ^b
Maximum Data Length	The maximum allowed length (in bytes) of the variable data object. If the actual length of the data exceeds this value, the message will be discarded. The value must not exceed 256 bytes, which is the maximum data length allowed for one frame.

a. Only relevant for Consume/Response transactions

b. Only used if "Object Delimiter" is set to "End Character" or "End Character Visible"

7.7 Checksum Object

Most serial protocols features some way of verifying that the data has not been corrupted during transfer. The Checksum Object calculates and includes a checksum in a transaction.

Parameter	Description
Error Check Start byte	Specifies the byte offset in the transaction to start checksum calculations on. ^a
Error Check Type	<p>This parameter specifies which type of algorithm to use:</p> <ul style="list-style-type: none"> • CRC (2 bytes) CRC-16 with 0xA001 polynome (Modbus RTU standard) • LRC (1 byte) All bytes are added together as unsigned 8-bit values. The two's complement of the result will be used as a checksum. (Modbus ASCII standard with Error Check Start Byte = 0x01 and Representation = ASCII) • XOR (1 byte) All bytes are logically XOR:ed together. The resulting byte will be used as a checksum. • ADD (1 byte) All bytes are added together as unsigned 16-bit values. The lowest 8 bits in the result will be used as a checksum.
Error check type combined with	<p>The binary value can be converted to its one's or two's complement. This conversion is carried out before ASCII formatting (see next parameter).</p> <ul style="list-style-type: none"> • None The checksum binary value is transmitted without conversion. • One's complement The checksum value will be converted to its one's complement (inverse code). Example: 00001100 will be transmitted as 11110011 • Two's complement The checksum value will be converted to its two's complement (complement code). Example: 00001100 will be transmitted as 11110100
Representation	<ul style="list-style-type: none"> • Binary The checksum is transmitted in binary format. • ASCII All characters in the checksum are converted to ASCII values.

a. In Generic Data Mode the Start character (if used) will not be included in the checksum calculation.

8. Commands

This information is only valid for the Master and Generic Data modes. For DF1 master mode, please refer to “Services” on page 52.

8.1 General

As mentioned previously, commands are actually predefined transactions that can be stored and reused. Just like regular transactions, commands consist of frame objects and are representations of the actual serial telegrams exchanged on the serial sub-network.

Adding a command to a node actually results in (a) transaction(s) being added according to the directions specified in the command. The frame objects in such a transaction may retrieve their values not only from parameters in the parameter section, but also from other sources such as the “SlaveAddress”-parameter (see “Node Parameters” on page 30). In such case, the parameters in the parameter section will be greyed out and cannot be edited directly.

In Master Mode, ACM comes preloaded with commands for most common Modbus RTU functions. Additional commands can easily be added using the Command Editor (see “The Command Editor” on page 46). For DF1 Master Mode, see “Services” on page 52. In Generic Data Mode, no predefined commands exist, but custom ones may be implemented as desired.

8.2 Adding & Managing Commands

To add a command to a node, right-click on the node in the Navigation Section and select “Add Command”.

A list of commands will appear:

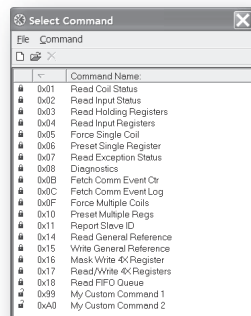

Select the desired command in the list, and select “Add Command” in the “Command”-menu. The specified command will be added to the node.

Just like other transactions, the frame objects of added command may be edited in the Navigation/Parameter Section or using the Transaction Editor. Note however that certain frame objects may be locked for editing.

8.2.1 Drop-down Menu

File

This menu features the following entries:

- **Select**
Add the currently selected Command to the node.
- **Exit**
Exit without adding a command to the node.

Command

This menu is used to manage the commands in the list:

- **Add Command**
Add a custom command to the list, and open the new command in the Command Editor.
See also “The Command Editor” on page 46.
- **Edit Command**
Edit the currently selected command using the Command Editor.
See also “The Command Editor” on page 46.
- **Delete Command**
Delete the currently selected command from the list. Note that some commands are fixed and cannot be deleted.

8.2.2 Toolbar Icons

The toolbar features icons for the Add, Edit and Delete Command functions.



8.3 The Command Editor

8.3.1 General

The Command Editor is used to define new commands and edit existing ones. This makes it possible to build a library of commands, which can be stored and reused at a later stage.

Note that the Command Editor is somewhat protocol-dependent in the sense that certain frame objects may not be deleted or altered.

The examples in this section use Master Mode. The procedures involved are similar in Generic Data Mode, but without the limitations imposed by the Modbus RTU protocol.

8.3.2 Basic Navigation

Open the Command Editor by selecting “Edit Command” or “Add Command” from the “Command”-menu.

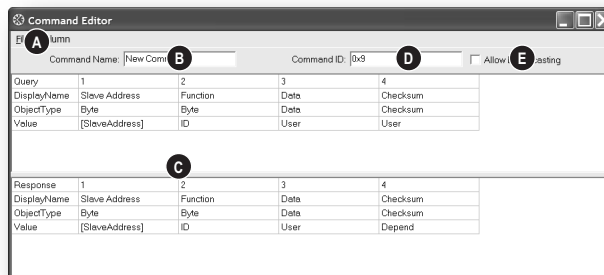

A: Drop-down Menu

See “Drop-down Menu” on page 47.

B: Name of Command

Actual name of the command, in text form.

C: Command Transactions

This section holds the actual transactions associated with the command. This can either be a query-response pair, or a single transaction, depending on the protocol mode etc.

D: Command ID

This can be used as desired when building the command, e.g. to specify the function code.

E: Other Settings

Setting	Description
Allow Broadcasting	Specifies if it is allowed to broadcast the command (only relevant in Master Mode)
Produce	The command is producing data (Generic Data Mode only)
Consume	The command is consuming data (Generic Data Mode only)

8.3.3 Drop-down Menu

File

This menu features the following entries:

- **Apply Changes**
Save changes and exit to the main window.
- **Exit**
Exit without saving.

Column

The functions in this menu alters the structure of the command.

- **Append Column**
Add another column to the command.
- **Insert Column**
Insert a column at the selected position.
- **Delete Column**
Delete the column at the selected position.

8.3.4 Editing a Command

As mentioned previously, the transaction section in the Command Editor represents the actual transactions associated with the command. Each column represents a frame object within the transaction.

Each column features four rows with the following parameters:

- **Query/Response/Produce/Consume**
The upper right cell indicates the direction of the transaction.
- **DisplayName**
Each column can be named so that the different parts of the command appears in a more user friendly manner when editing its settings in the Transaction Editor or in the Parameter Section of the Main Window.
- **ObjectType**
This row specifies the type of frame object that shall be used for the column.
- **Value**
This row specifies where the frame object shall retrieve its value/settings.

Value	Description
Depend	This setting is only relevant for Responses in Master Mode. The value will be retrieved from the corresponding part of the "Query"-transaction.
Id	Value will be retrieved from the "Command ID"-setting (see "Basic Navigation" on page 46).
User	Settings associated with the object can be edited by the user.
[SlaveAddress]	Value will be retrieved from the "SlaveAddress"-parameter (see "Node Parameters" on page 30).
(other settings)	Other settings are no longer supported.

8.3.5 Example: Specifying a Modbus-RTU Command in Master Mode

In the following example, a Modbus-RTU command is created in Master Mode. In Modbus-RTU, a transaction always feature the following parts:

- Slave Address (1 byte)
- Function Code (1 bytes)
- A data field
- CRC (CRC-16)

Furthermore, each command always consists of a query and a response.

- **Example Query**

Query	1	2	3	4
DisplayName	Slave Address	Function	Data	Checksum
Object Type	Byte Object	Byte Object	Data Object	Checksum Object
Value	[SlaveAddress]	ID	User	User
	<i>The value of this byte constant will be set using the "SlaveAddress" parameter (see "Node Parameters" on page 30).</i>	<i>The value of this byte constant will be set using the "Command ID"-field.</i>	<i>The size and location of the data associated with this object is determined by the user.</i>	<i>The checksum type etc can be selected by the user. By default, this is set to match the Modbus-RTU standard.</i>

- **Example Response**

Response	1	2	3	4
DisplayName	Slave Address	Function	Data	Checksum
Object Type	Byte Object	Byte Object	Data Object	Checksum Object
Value	[SlaveAddress]	ID	User	Depend
	<i>This value is linked to the "SlaveAddress" parameter in the parameter window.</i>	<i>The value of this byte constant will be set using the "Command ID"-field.</i>	<i>The size and location of the data associated with this object is determined by the user.</i>	<i>This object will retrieve its settings from the corresponding object in the Query.</i>

By default, the Modbus-RTU-specific frame objects are already in place, and a data object is inserted between the function code and the CRC. These objects cannot be moved or deleted, however it is possible to add additional objects between the function code and the CRC as desired.

Name the new command by entering its name in the "Command Name" field, and enter a suitable function code in the "Command ID"-field. If the command is allowed to be broadcasted, check the "Allow Broadcasting" checkbox.

9. DF1 Protocol Mode

This mode makes the Anybus Communicator act as a DF1 protocol master on the sub-network.

9.1 General

In DF1 master mode, communication is based on “services”. A “service” represents a set of commands and operations on the sub-network, that is predefined in the Anybus Communicator. Each service is associated with a set of parameters controlling how and when to use it on the sub-network.

The communication is based on a query-response scheme, where the gateway issues a query on the sub-network. The addressed node on the sub-network is expected to issue a response to that query. Nodes are not permitted to issue responses spontaneously, i. e. without first receiving a query.

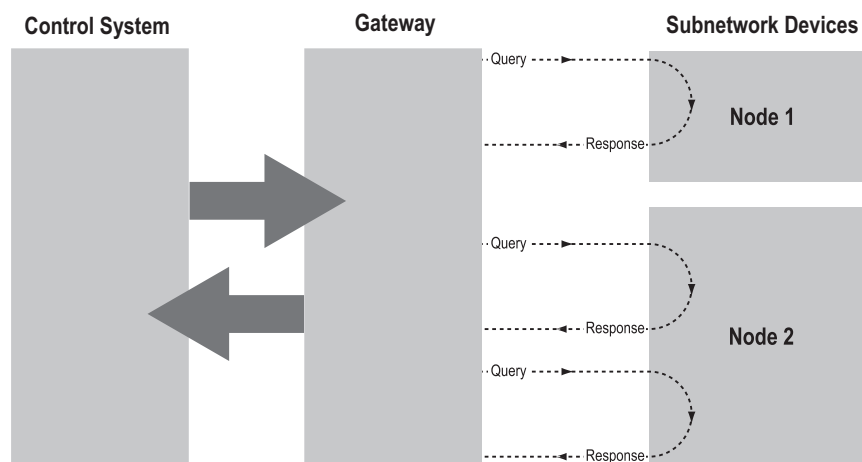

In DF1 Master Mode, ACM comes preloaded with a number of services, that can be selected by the user. The actual DF1 commands, that perform the services during runtime, are predefined in the Anybus Communicator. The configuration of the services is performed by right-clicking on a node in the ACM and selecting “Add Command”.

9.2 Communicator Parameters



Interface

Currently, only serial communication is supported.

Control/Status Word

(See “Control and Status Registers” on page 65).

Value	Description
Enabled	Enable the Control and Status Registers. The “Data Valid”-bit in the Control Register must be set to start the sub-network communication.
Enabled but no startup lock	This setting is similar to “Enabled”, except that the control system is not required to set the “Data Valid”-bit to start the sub-network communication.
Disabled	This setting completely disables the Control and Status Registers.

Module Reset

This parameter specifies how the gateway will behave in the event of a fatal error.

Value	Description
Enabled	The gateway will be restarted, and no error will be indicated to the user.
Disabled	The gateway will halt and indicate an error.

Protocol Mode

This parameter specifies which protocol mode to use for the sub-network.

Value	Description
DF1	This mode is intended for the DF1 protocol. The Anybus Communicator can only be configured as a Master with half-duplex communication. Note: This is the only mode available if you intend to configure an ABC module for DF1.

See also “Protocol Modes” on page 17.

Statistics

The Transmit- and Receive Counters indicate how many transactions that have successfully been exchanged on the sub-network. This feature is primarily intended for debugging purposes.

- **Receive Counter Location**
Specifies the location of the Receive Counter in the internal memory buffer.
- **Transmit Counter Location**
Specifies the location of the Transmit Counter in the internal memory buffer.
- **Statistics**
Enables/disables the Receive and Transmit Counters.

9.3 Sub-network Parameters



Communication

These parameters specify the actual communication settings used for the sub-network.

Parameter	Description	Valid Settings
Bitrate (bits/s)	Selects the bit rate	2400 4800 9600 19200 38400 (Default)
Data bits	Selects the number of data bits	8
Parity	Selects the parity mode	None, Odd, Even
Physical standard	Selects the physical interface type	RS232, RS422, RS485
Stop bits	Number of stop bits.	1

DF1 Settings

Parameter	Description	Default
Master Node Address	Node address of the master, valid values: 0–254	1
Poll time, active slaves (10 ms)	Determines how often the slave shall be polled in steps of 10 ms	100 ms ^a
Poll time, inactive slaves (10 ms)	Determines how often the slave shall be polled in steps of 10 ms	1000 ms ^b

- a. The default value is given as 10 in the parameter window. Each change of 10 ms either increases or decreases this value by 1, i.e. 9 represents a poll time of 90 ms and 11 represents a poll time of 110 ms.
- b. The default value is given as 100 in the parameter window. Each change of 10 ms either increases or decreases this value by 1, i.e. 99 represents a poll time of 990 ms and 101 represents a poll time of 1010 ms.

9.4 Node Parameters



To gain access to the parameters described in this section, select a node in the navigation section. For more information about nodes, see “Nodes” on page 30.

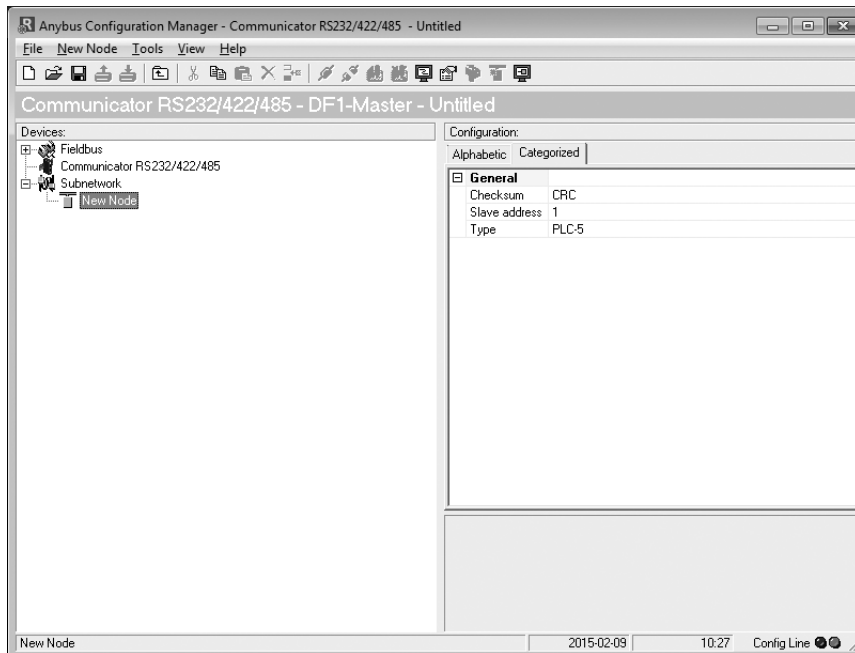

Parameter	Description	Valid Settings
Checksum	Selects the type of checksum on the network.	BCC CRC (default)
Slave Address	The value entered here sets the node address.	0-254
Type	The PLC type of the slave	PLC-5 SLC500 MicroLogix

9.5 Services

Services are commands that can be stored and reused. The user configures each slave with services that can be issued from the master. A total of 50 services are allowed.

The Anybus Communicator supports a selection of DF1 commands. When the gateway is going to execute a service, it automatically chooses the appropriate DF1 command(s) that are used to perform the service on the selected DF1 node type.

9.5.1 Available Services

Right click on the node, and choose Add Command. A pop-up window will show the four different services that are available:

- Integrity check
- Read diagnostics
- Read data
- Write data

A maximum of 50 services in total (for all nodes) can be selected.

The predefined services can be configured to suit the application. Select a service to show the parameters.

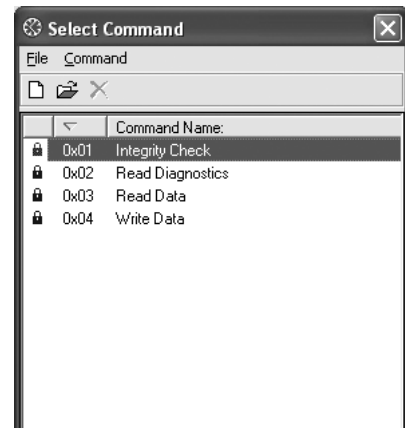

General Configuration Parameters

These parameters are common to all services, but the settings are individual to each instance of a service.

General:

Parameter	Description	Valid settings
Offline options for fieldbus	The action to take for this service if the fieldbus goes offline. This option affects the data that is sent out to the sub-network.	Clear Freeze Noscanning
Offline options for sub-network	The action to take for this service if the sub-network goes offline. This option affects the data that is reported to the fieldbus master.	Clear Freeze
Update mode	The update mode for this service	Cyclically On data change Single shot Change of state on trigger

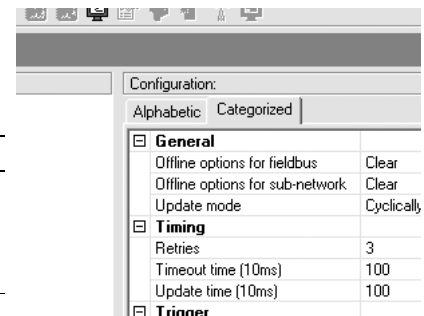

Timing:

Parameter	Description	Default
Retries	The number of times to resend this service before the node is disconnected	3
Timeout time (10 ms)	The time to wait before resending this service (in steps of 10 ms) ^a	1000 ms
Update time (10 ms)	The minimum time between two services of this kind (in steps of 10 ms) ^a	1000 ms

a. The default value is given as 100 in the parameter window. Each change of 10 ms either increases or decreases this value by 1, i.e. 99 represents a poll time of 990 ms and 101 represents a poll time of 1010 ms.

Trigger:

Parameter	Description	Default
Request Trigger byte address	The memory location of the trigger byte this service uses for updates on trigger byte changes	0x05FF
Response Trigger byte	Enables/disables the trigger byte	Disabled
Response Trigger byte address	The memory location of the trigger byte this service uses for updates on trigger byte changes Valid settings range from 0x200 to 0x3FF and 0x400 to 0xFF	0x05FF

9.6 Integrity Check

This service checks that a node is up and running correctly. A telegram is sent to the node. The node mirrors and returns the telegram. No configuration is needed, apart from the general parameters, common to all services.

9.7 Read Diagnostics

This service reads diagnostic information from the module.

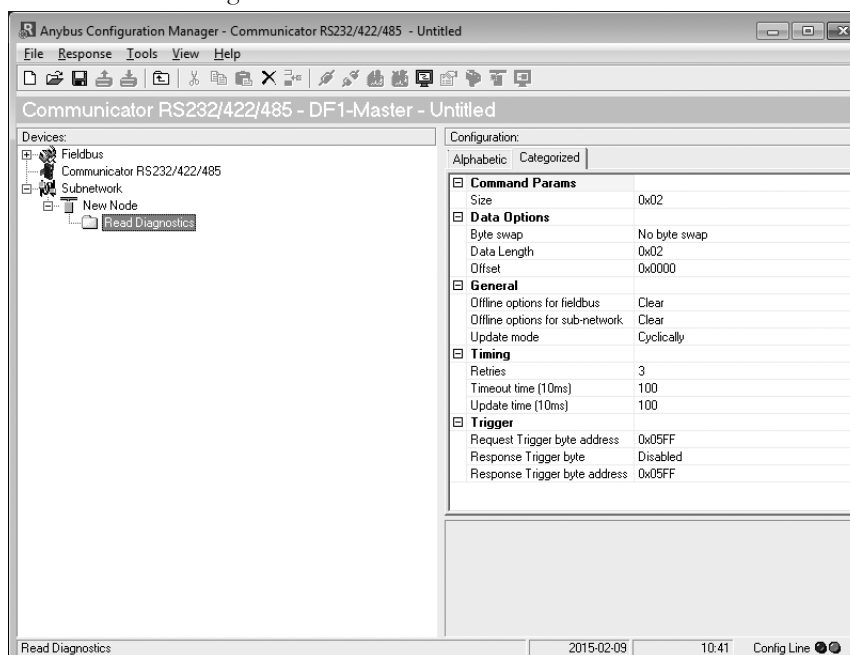

Command parameters

The command parameter Size decides the amount of data that can be read. The size is given in bytes which means that it always has to be an even number as only whole elements can be read from the slave. One bit/integer element is 2 bytes and one float element is 4 bytes. The range of the size differs, depending on node type:

	PLC-5	SLC500	MicroLogix
Size range (in bytes)	1–26	1–28	1–26

Data options:

Parameter	Description	Valid settings
Byte swap	Determines if the data shall be swapped	No byte swap Swap words Swap double words
Data length	The number of bytes, read from the DF1 network, to write to the area determined by the Offset parameter	≤ Size
Offset	The offset in the internal memory buffer in the module, where the data shall be read.	

9.8 Read Data

This service is used to read data from the nodes in the sub-network.

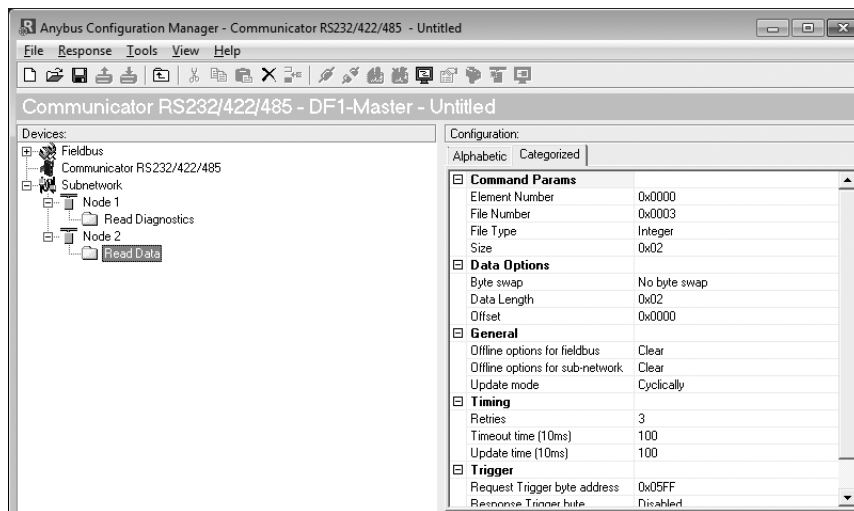

Command Parameters

Parameter	Description	Valid settings
Element Number	The element number of the data file to be accessed within the slave.	PLC-5: 0–999 SLC500: 0–255 MicroLogix: 0–255
File number	The file number of the data file to be accessed.	PLC-5: 3, 7, 8, 10–999 SLC500: 3, 7, 8, 10–255 MicroLogix: 3, 7, 8, 10–255
File type	The file type of the data to be accessed.	Integer Bit Float
Size	The number of bytes to read from the slave. One bit/integer element is 2 bytes and one float element is 4 bytes. The parameter must have an even value as only whole elements can be read from the slave.	PLC-5: 2–240 SLC500: 2–236 MicroLogix: 2–242

Data Options

Parameter	Description	Valid settings
Byte swap	Determines if the data shall be swapped.	No byte swap Swap words Swap double words
Data length	The number of bytes, read from the DF1 network, to write to the area determined by the Offset parameter	≤ Size
Offset	The offset in the internal memory buffer in the module, where the data shall be read. See “Memory Map” on page 15. Note: If the control and status registers are enabled (default), first available data location will be: Input area 0x002, Output area 0x202.	-

9.9 Write Data

This service is used to write data to the nodes in the sub-network. The parameters to be configured are the same as for the service Read Data. The only difference is that data is read from the internal memory buffer in the Anybus Communicator and written to the sub-network bus, instead of being written to the internal memory buffer.

10. Sub-network Monitor

10.1 General

The sub-network Monitor is intended to simplify configuration and troubleshooting of the sub-network. Its main function is to display the data allocated for sub-network communication and detect if any area has been allocated twice (i.e if a collision has occurred).

All configured nodes, and their transactions, are listed in the middle of the screen (B). Selecting and de-selecting single transactions makes it possible to view any combination of allocated data.

Note: The sub-network monitor has a negative influence on the overall performance of the gateway. Therefore the monitor functionality should be used with care.

10.2 Operation

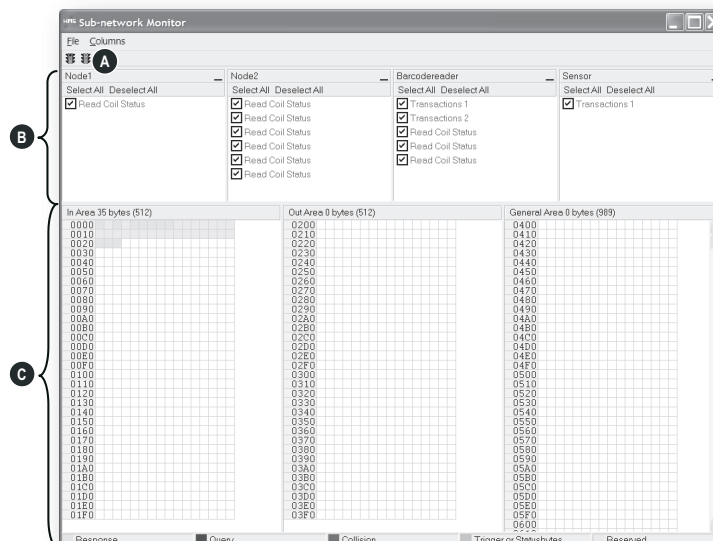

A: Start Network & Stop Network Icons

These icons controls the sub-network activity. To stop all activity, click on the red light. To start the sub-network again, click on the green light.



B: Nodes / Transactions

To view data blocks associated with a transaction, select the transaction in the list. The corresponding data will then appear in the Monitor Section (C).

C: Monitor Section

This section visualizes how data is allocated in the Input, Output and General Data areas.

Color	Meaning
White	Not allocated
Yellow	Data allocated by a Response or Consume transaction
Blue	Data allocated by a Query or Produce transaction
Red	Collision; area has been allocated more than once
Grey	Reserved (illustrates memory consumption, area can be allocated if necessary)
Green	Data allocated by Trigger byte, Transmit/Receive Counter, or Control/Status Registers

11. Node Monitor

11.1 General

The Node Monitor can provide valuable information when setting up the communication with the sub-network, by allowing individual commands to be issued manually, and monitoring the response (if applicable). It also provides an overview of the memory used by a particular node.

Note: The node monitor has a negative influence on the overall performance of the gateway, i.e. it should be used only when necessary.

The Node Monitor behaves somewhat differently in the three protocol modes:

- **Master Mode and DF1 Master Mode**

The selected Command (Query Transaction) or Service is sent to the sub-network. The response to the Query can be monitored in the Response Section.

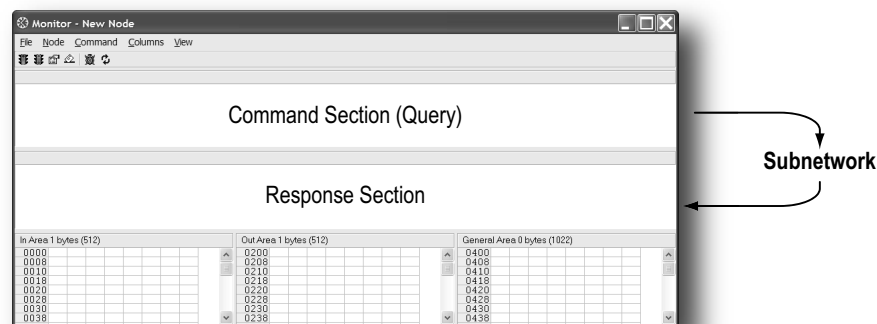

- **Generic Data Mode**

The selected command (Transaction Produce) is sent to the sub-network. It is not possible to monitor any responses etc. generated by other nodes.

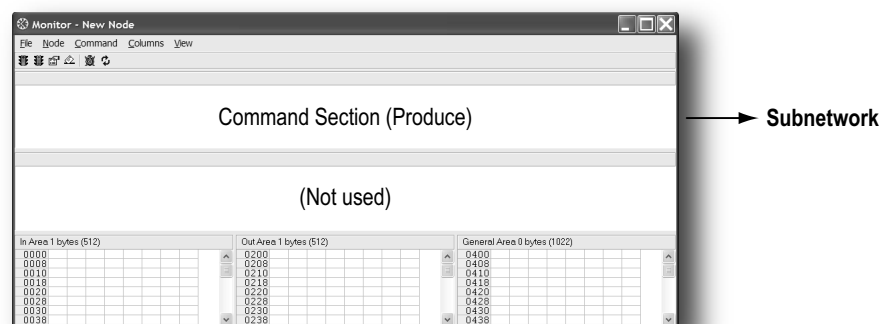

11.2 Navigating the Node Monitor

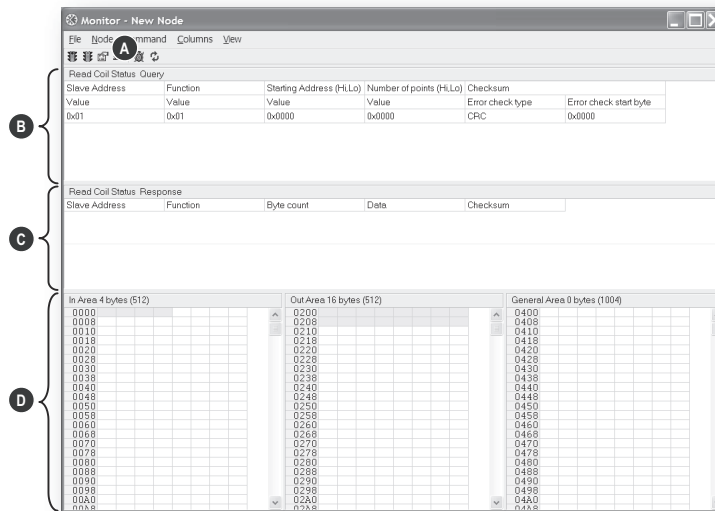

A: Drop-down Menu & Toolbar Icons

See “Drop-down Menu” on page 59 and “Toolbar Icons” on page 60.

B: Command Section

This section holds the currently selected command. The individual frame objects in the command can be edited in a similar way as in the Transaction and Command Editors.

C: Response Section (Master Mode and DF1 Master Mode only)

This section holds the response to the selected Command.

D: Monitor Section

This section displays the data associated with the node. Areas in dark grey are reserved for the Status & Control Registers, and areas displayed in light grey represent the data that is used by the node.

The data displayed in this section will be refreshed based on the refresh-icons in the toolbar. For more information, see “Toolbar Icons” on page 60.

11.2.1 Drop-down Menu

File

There is only one entry in this menu:

- **Exit**
This will close the Node Monitor. Note however that if the node has been disabled using “Stop Node” (see below), it will not resume data exchange until enabled again using “Start node”.

Node

This menu controls the data exchange for the node. This feature can help isolate problems associated with a particular node.

- **Start Node**
Enable the transactions associated with the node.
- **Stop Node**
Disable the transactions associated with the node.

Command

This menu is used to specify and issue a command manually.

- **Select Command**
Select a command to be sent to the sub-network.
- **Send Command**
Send the specified command to the sub-network.

Columns

This menu specifies the number of columns in the Monitor Section.

- **Free**
The number of columns depends on the width of the window.
- **8 Multiple**
The number of columns will be fixed to 8.

View

This menu specifies the data representation in the Monitor Section.

- **Hex**
Display the data in hexadecimal format.
- **Decimal**
Display the data in decimal format.

11.2.2 Toolbar Icons

The toolbar features icons for the most commonly used functions.

- **Start Node & Stop Node**

These icons corresponds to the functions in the “Node” menu.

See also “Node” on page 59.



Start



Stop

- **Select Command & Send Command**

These icons corresponds to the functions in the “Command” menu.

See also “Command” on page 59.



Select



Send

- **Resume Refresh & Stop Refresh**

The data displayed in the Monitor Section will normally be refreshed automatically (cyclically).

Click on “Stop” to stop automatic data refresh. Data will now only be refreshed if you click “Refresh” (see below).

Press “Resume” to resume automatic refreshing of data.



Stop



Resume

- **Refresh**

Refreshes the data displayed in the Monitor Section.



Refresh

12. Data Logger

12.1 General

This feature allows the sub-network traffic to be logged into a buffer for examination. This may provide valuable information when debugging the lowest levels of the sub-network communication.

Note that the logger function is part of the gateway itself and is separate from ACM. This means that logging can be performed even if the gateway is physically disconnected from the PC running ACM.

12.2 Operation

Start & Stop Logging

- **Start logging**
Select “Start Logging” in the “Tools”-menu. ACM will then prompt for the desired mode of operation, see below.
- **Stop logging**
Select “Stop Logging” in the “Tools”-menu. This will open the log-window, see below.

Modes of Operation

Select the desired mode of operation and click “OK” to start logging data.

- **Log until full**
Data will be logged until the log-buffer is full.
- **Log continuously**
Data will be logged continuously until logging is stopped by clicking “Stop Logging”. The log-buffer will contain the most recent data.

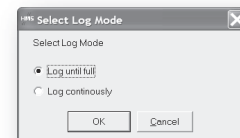

Log Window

The logged data is displayed in hexadecimal, decimal and ASCII format for both directions. The time between the log-entries is displayed in a separate column.

The data may optionally be saved in ASCII text format by clicking “Create Text file”.

Click “Close” to exit.

Line #	Relative Time [ms]	Hex	Dec	ASCII	Hex	Dec	ASCII
1	0				0x6A	10	
2	0				0x02	2	
3	1				0x00	0	
4	0				0x00	0	
5	1				0x00	0	
6	1				0x01	1	
7	0				0x05	5	
8	1				0x71	113	q
9	4	0x04	4				
10	1	0x03	3				
11	0	0x02	2				
12	1	0x00	0				
13	1	0x00	0				
14	0	0x10	16				
15	1	0x05	5				
16	6				0x6A	10	
17	0				0x10	16	
18	1				0x01	1	
19	1				0x00	0	
20	0				0x00	0	
21	1				0x01	1	
22	0				0x02	2	
23	1				0x00	0	

12.3 Configuration

By default, the log-buffer can hold 512 bytes of data in each direction. To specify a different size for the buffer, select “Options” in the “Tools”-menu.

A window with various settings will appear. Select the “Module” tab, and enter the desired number of buffer entries under “Size of logbuffer” (valid settings range from 1–512).

Click “Apply” to validate the new settings.

Click “OK” to exit.

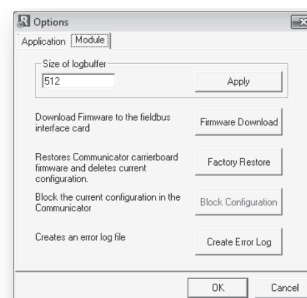

13. Configuration Wizards

13.1 General

When creating a new subnetwork configuration, the Anybus Configuration Manager provides a choice between starting out with a blank configuration, or using a predefined template, a.k.a a wizard.

The wizard automatically creates a subnetwork configuration based on information supplied by the user, i.e the user simply has to “fill in the blanks”. Note however that this will only work when the subnetwork fits the wizard profile; in all other cases the “Blank Configuration” option must be used.

13.2 Selecting a Wizard Profile

The following window appears each time the Anybus Configuration Manager is started, or upon selecting the “New” entry in the “File” menu (unless it has been disabled in the “Options” menu, see “Tools” on page 24). does not

Currently, the following wizards are available:

- **Wizard - Modbus RTU Master**

This option is suitable for Modbus RTU-based networks.

See also “Wizard - Modbus RTU Master” on page 64.

- **Blank Configuration**

This option creates an empty configuration.

Highlight the desired wizard and click “OK” to continue.

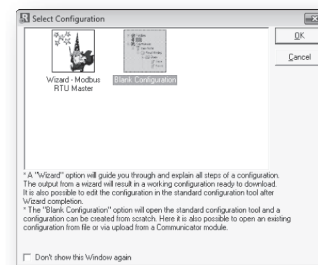

13.3 Wizard - Modbus RTU Master

This wizard can be used to create a Modbus-RTU based network configuration based on certain information about the subnetwork. The online help system explains each configuration step in detail.

- **Important Notes:**

Many OEM devices do not fully comply with the Modbus standard. For example, they may implement a variation of this standard or be limited to the use of specific Modbus commands other than the ones used by this wizard. In all cases, the user should consult the documentation of the devices that shall be used on the subnetwork for information about their serial communication requirements, and if necessary contact the manufacturer of the device to obtain further information about the serial communication protocol.

In the event that the wizard does not handle a particular Modbus command required by a device, it is possible to specify this command manually as a transaction in the Anybus Configuration Manager.

Using this wizard involves the following steps:

Step 1: Communicator Type

Select “DeviceNet”.

Click “Next” to continue.

Tip: It is possible to return to a previous menu at any time without losing any settings by clicking “Previous”.

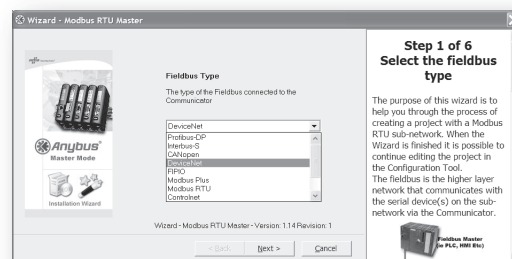

Step 1a: I/O Sizes

This parameter is used to set the sizes of the in/out data areas. For more information, see “IO Sizes” on page 27.

Click “Next” to continue.

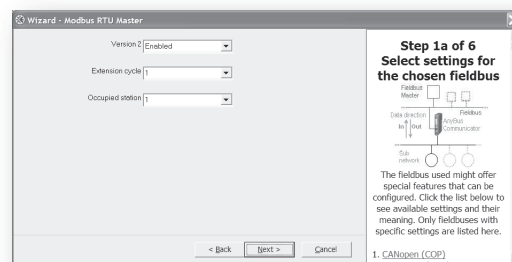

Step 2: Physical Settings

Select the physical properties of the subnetwork.

Click “Next” to continue.

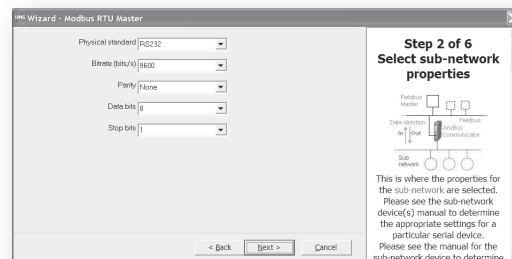

Steps 3 - 6

Consult the online help system for further information.

14. Control and Status Registers

14.1 General

The Control and Status Registers are disabled by default, but can be enabled using ACM (see “Control/Status Word” on page 28). These registers form an interface for exchanging status information between the sub-network and the fieldbus control system.

The main purpose of these registers is to...

- Report sub-network related problems to the fieldbus control system
- Ensure that only valid data is exchanged in both directions
- Enable the fieldbus control system to start/stop data exchange with selected nodes on the sub-network

If enabled, these registers occupy the first two bytes in the input and output data areas (0x000–0x001 and 0x200–0x201 respectively), which means they can be accessed from the fieldbus just like any other data in these areas.

Note: Internally, these registers are stored in Motorola-format (i.e. MSB first). If the higher level network uses a different byte order, the upper and lower bytes will appear swapped.

14.1.1 Handshaking Procedure

A special handshaking procedure, which is illustrated in the two flowcharts below, must be followed when accessing these registers to ensure that both parts receive proper information.

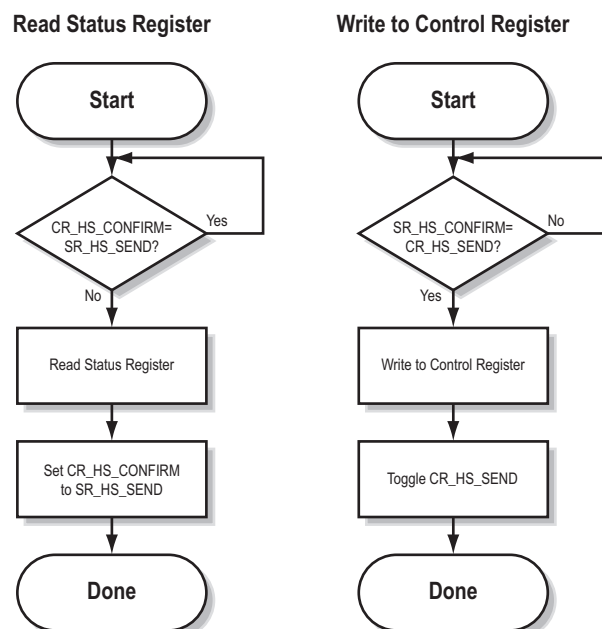

14.1.2 Data Consistency

The “Data Valid”-bits in the Control and Status Registers are used to ensure data consistency during start-up and fieldbus offline/online transitions.

If the “Control/Status Word”-parameter in ACM is set to “Enabled”, the gateway will wait for the fieldbus control system to set the “Data Valid”-bit in the Control Register before it starts exchanging data on the sub-network.

If the same parameter is set to “Disabled” or “Enabled but no startup lock”, communication will start as soon as the fieldbus goes online.

State Machine

The fieldbus network participation can be described using a state machine as described below.

A: Offline (No data exchange)

1. Clear the “Data Valid”-bit in the Control Register.
2. Write initial data to the Output Area according to the sub-network configuration.
3. Wait until the fieldbus control system and the gateway are online on the fieldbus network, and shift to state B.

B: Online (Not yet exchanging data)

4. Wait until the “Data Valid”-bit in the Status Register is cleared by the gateway.
5. Set the “Data Valid”-bit in the Control Register.
6. When the “Data Valid”-bit in the Status Register is set by the gateway, shift to state C.
7. If the gateway goes offline on the fieldbus, shift to state A.

C: Online (Exchanging data)

Exchanging valid data in both directions.
If the gateway goes offline on the fieldbus, shift to state A.

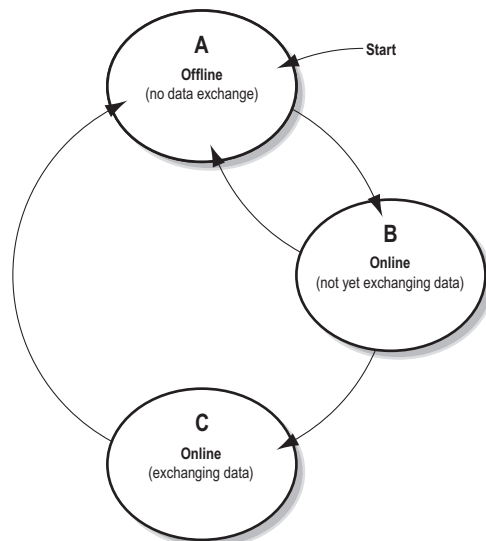

Note: The gateway cannot spontaneously clear the “Data Valid”-bit in the Status Register.

Latency

The “Data Valid”-bit in the Status Register may in some cases be delayed. This latency can be caused by a missing node or a bad connection to a node with a long timeout value assigned to it.

Therefore, the fieldbus control system should not wait for this bit to be set before communicating with the sub-network devices; it should be considered as an aid for the fieldbus control system to know when all data has been updated.

14.2 Status Register Contents (Gateway to Control System)

14.2.1 General Information

The Status Register is (if enabled) located at 0x000–0x001 and constitutes a bit-field as follows:

bit(s)	Name	Description
15	Send (SR_HS_SEND)	These bits control the handshaking towards the fieldbus control system.
14	Confirm (SR_HS_CONFIRM)	See also... - “Handshaking Procedure” on page 65 - “Control Register Contents (Control System to Gateway)” on page 69
13	Data Valid (Master Mode and DF1 Master Mode Only)	This bit is set when all transactions have been executed successfully at least once. Once set, it will not change. 1:Data Valid 0:Data not Valid Note: This bit is not used in Generic Data Mode.
12... 8	Status Code	This field holds the last status report from the gateway.
7... 0	Data	See also... - “Status Codes in Master Mode and DF1 Master Mode” on page 67 - “Status Code in Generic Data Mode” on page 68

Note: Internally, this is treated as a Motorola-format word (i.e. MSB first). If the higher level network uses a different byte order, the upper and lower bytes will appear swapped.

14.2.2 Status Codes in Master Mode and DF1 Master Mode

(This table is valid only in Master Mode and DF1 Master Mode).

Code	Condition	Type	Data	Description
0x00	Retransmission Counter Updated	Warning	Counter	The number of retransmissions on the sub-network has increased. If this problem persists, this may eventually trigger a Single- or Multiple Node(s) Missing condition.
0x01	Single Node Missing	Error	Slave address	A single node is missing.
0x02	Multiple Nodes Missing	Error	Number of nodes	Multiple nodes are missing.
0x03	Buffer Overrun	Warning	Slave address	A node returned more data than expected.
0x04	Other Error	Error	Slave address	Undefined error
0x1F	No Error	Warning	-	No errors

Note: Conditions of type “Error” will eventually be followed by a “No Error” condition when the cause has been resolved. Conditions of type “Warning” are however considered informational and may not necessarily be followed by a “No Error” condition later on.

14.2.3 Status Code in Generic Data Mode

(This table is valid only in Generic Data Mode).

Code	Condition	Type	Data	Description
0x00	Invalid Transaction Counter Updated	Error	Counter	The number of invalid transactions (i.e. received transactions which does not match any of the consume-transactions defined in the sub-network configuration) has increased.
0x01	Frame Error	Warning	-	End character is enabled, but a message delimiter timeout occurs prior to receiving it.
0x02	Offline Timeout Counter Updated	Error	Counter	The of number of timed out consume-transactions has increased. See also... - "Consume Transactions" on page 36 (Offline timeout time)
0x03	Buffer Overrun	Warning	-	A node returned more data than expected - or - the gateway was unable to finish processing a message prior to receiving a new one.
0x04	Other Error	Error	-	Undefined error
0x1F	No Error	Warning	-	No errors

Note: Conditions of type "Error" will eventually be followed by a "No Error" condition when the cause no longer is detected. Conditions of type "Warning" are however considered informational and may not necessarily be followed by a "No Error" condition later on.

14.3 Control Register Contents (Control System to Gateway)

14.3.1 General Information

The Control Register is (if enabled) located at 0x200–0x201 and constitutes a bit-field as follows:

bit(s)	Name	Description
15	Confirm (CR_HS_CONFIRM)	These bits control the handshaking towards the gateway.
14	Send (CR_HS_SEND)	See also... - "Handshaking Procedure" on page 65 - "Status Register Contents (Gateway to Control System)" on page 67
13	Data Valid	This bit controls data consistency (see "Data Consistency" on page 66). 1:Output Area valid; exchange data on the sub-network 0:Output Area not valid; do not exchange data on the sub-network Note: This bit is only relevant if the Control/Status Registers are set as "Enabled"
12	Execute Command	If set, the specified command will be executed by the gateway (see below).
11... 8	Control Code	This field holds commands which can be executed by the gateway (see below).
7... 0	Data	See also... - "Control Codes in Master Mode and DF1 Master Mode" on page 69 - "Control Codes in Generic Data Mode" on page 69

Note: Internally, this is treated as a Motorola-format word (i.e. MSB first). If the higher level network uses a different byte order, the upper and lower bytes will appear to be swapped.

14.3.2 Control Codes in Master Mode and DF1 Master Mode

(This table is valid only in Master Mode and DF1 Master Mode).

Code	Instruction	Data	Description
0x00	Disable Node	Actual node address	Disables the specified node.
0x01	Enable Node	Actual node address	Enables a previously disabled node.
0x02	Enable Nodes	Actual number of nodes to enable	Enables the specified number of nodes, starting from the first node in the configuration. Remaining nodes will be disabled.

14.3.3 Control Codes in Generic Data Mode

(No Control Codes are currently supported in this mode).

15. CIP Object Implementation

DeviceNet is based on the Control and Information protocol (CIP) which is also the application layer for ControlNet and EtherNet/IP.

The following CIP-objects are implemented in this product:

Mandatory Objects

Object	Page
Identity Object, Class 01h	71
Message Router, Class 02h	72
DeviceNet Object, Class 03h	73
Assembly Object, Class 04h	74
Connection Object, Class 05h	75
Acknowledge Handler Object, Class 2Bh	77

Vendor Specific Objects

Object	Page
Diagnostic Object, Class AAh	78
Parameter Data Input Mapping Object, Class B0h	79
Parameter Data Output Mapping Object, Class B1h	80

15.1 Identity Object, Class 01h

15.1.1 General Information

Object Description

-

Implemented Services

Class services: Get Attribute All
 Get Attribute Single

Instance services: Get Attribute All
 Get Attribute Single
 Reset

15.1.2 Class Attributes

#	Access	Name	Type	Value	Description
1	Get	Revision	UINT	0001h	Revision 1

15.1.3 Instance Attributes

#	Access	Name	Type	Value	Description
1	Get	Vendor ID	UINT	Default: 005Ah	HMS Industrial Networks AB
2	Get	Device Type	UINT	Default: 000Ch	Communication Adapter
3	Get	Product Code	UINT	Default: 003Ch	Anybus Communicator for DeviceNet
4	Get	Revision	Struct of:		-
			USINT		Major fieldbus version
			USINT		Minor fieldbus version
5	Get	Status	WORD	-	Device status, see table below
6	Get	Serial Number	UDINT	Module serial number	Serial number of the module
7	Get	Product Name	SHORT_STRING	"AnyBus-C"	Product name
8	Get	Config Consist Value	UINT	N/A	-

Device Status

bit(s)	Name
0	Module Owned
1	(reserved)
2	Configured
3... 7	(reserved)
8	Set for minor recoverable faults
9	Set for minor unrecoverable faults
10	Set for major recoverable faults
11	Set for major unrecoverable faults
12... 15	(reserved)

15.2 Message Router, Class 02h

15.2.1 General Information

Object Description

-

Supported Services

Class services: Get Attribute Single

Instance services: -

15.2.2 Class Attributes

#	Access	Name	Type	Value	Description
1	Get	Revision	UINT	0001h	Revision 1

15.2.3 Instance Attributes

-

15.3 DeviceNet Object, Class 03h

15.3.1 General Information

Object Description

-

Implemented Services

Class services: Get Attribute Single

Instance services: Get Attribute Single

15.3.2 Class Attributes

#	Access	Name	Type	Value	Description
1	Get	Revision	UINT	0002h	Revision 2

15.3.3 Instance Attributes

#	Access	Name	Type	Value	Description
1	Get	MAC ID	USINT	N/A	Currently used MacID
2	Get	Baud Rate	USINT	N/A	Currently used baudrate: 1 = 125 kbps 2 = 250 kbps 3 = 500 kbps
5	Get	Allocation Information	Struct of:		-
			BYTE	N/A	Allocation choice byte
			USINT	N/A	Master's MAC ID

15.4 Assembly Object, Class 04h

15.4.1 General Information

Object Description

This object provides access to the I/O Data in the Input- and Output Data areas in the Anybus Communicator.

See also...

- “Data Representation on DeviceNet” on page 20
- “Fieldbus Settings” on page 27

Services

Class services: Get Attribute Single

Instance services: Get Attribute Single
 Set Attribute Single

15.4.2 Class Attributes

#	Access	Name	Type	Value	Description
1	Get	Revision	UINT	0001h	Revision 1

15.4.3 Instance Attributes - Instance/Connection Point 64h

This instance is used to access I/O Data (Input) in gateway memory.

#	Access	Name	Type	Value	Description
3	Get	Data	Array of BYTE	-	Data produced by the ABC

15.4.4 Instance Attributes - Instance/Connection Point 96h

This instance is used to access I/O Data (Output) in gateway memory.

#	Access	Name	Type	Value	Description
3	Set	Data	Array of BYTE	-	Data consumed by the ABC

15.5 Connection Object, Class 05h

15.5.1 General Information

Object Description

-

Implemented Services

Class services: Get Attribute Single

Instance services: Get Attribute Single
Set Attribute Single

15.5.2 Class Attributes

#	Access	Name	Type	Value	Description
1	Get	Revision	UINT	0002h	Revision 2

Instance 1 = Explicit messaging connection (Predefined in DeviceNet object)

Instance 2 = Polled connection / COS / Cyclic consuming connection

Instance 3 = Bit strobe connection

Instance 4 = COS / Cyclic producing connection

Instance 10 - 14 = Explicit connection (UCMM allocated)

15.5.3 Instance 1 & 10...14 (Explicit Messaging Connection) Attributes

#	Access	Name	Type	Value	Description
1	Get	State	USINT	N/A	0 = Non existent 1 = Configuring 3 = Established 4 = Timeout 5 = Deferred delete
2	Get	Instance type	USINT	0	Explicit messaging connection

15.5.4 Instance 2 (Polled Connection) Attributes

#	Access	Name	Type	Value	Description
1	Get	State	USINT	N/A	0 = Non existent 1 = Configuring 3 = Established 4 = Timeout
2	Get	Instance type	USINT	1	I/O Connection

15.5.5 Instance 3 (Bit-strobe connection) Attributes

#	Access	Name	Type	Value	Description
1	Get	State	USINT	N/A	0 = Non existent 1 = Configuring 3 = Established 4 = Timeout
2	Get	Instance type	USINT	1	I/O Connection

15.5.6 Instance 4 (COS/Cyclic connection) Attributes

#	Access	Name	Type	Value	Description
1	Get	State	USINT	N/A	0 = Non existent 1 = Configuring 3 = Established 4 = Timeout
2	Get	Instance type	USINT	1	I/O Connection
3	Get	Transport Class trigger	BYTE	N/A	Defines the behaviour of the connection
4	Get	Produced Connection ID	UINT	N/A	CAN ID for transmission
5	Get	Consumed Connection ID	UINT	N/A	CAN ID for reception
6	Get	Initial Comm Characteristics	BYTE	0Fh (No ACK)	Produces over message group 1 Does not consume.
				01h (ACK)	Produces over message group 1 Consumes over message group 2
7	Get	Produced Connection Size	UINT	N/A	Number of bytes transmitted across this connection
8	Get	Consumed Connection Size	UINT	0	Number of bytes received across this connection
9	Get/Set	Expected Packet Rate	UINT	0	Timing associated with this connection
12	Get	Watchdog timeout action	USINT	N/A	0 = Transition to the timed out state 1 = Auto Delete 2 = Auto Reset 3 = Deferred Delete
13	Get	Produced Connection path length	UINT	0006h	Number of bytes in the produced connection path attribute
14	Get	Produced Connection Path	EPATH	20 04 24 66 30 03h	Application object producing data on this connection
15	Get	Consumed Connection path length	UINT	0004h	Number of bytes in the consumed connection path length attribute
16	Get	Consumed Connection Path	EPATH	20 2B 24 01h	Specifies the application object(s) that are to receive the data consumed by this connection object

15.6 Acknowledge Handler Object, Class 2Bh

15.6.1 General Information

Object Description

-

Implemented Services

Class services: Get Attribute Single

Instance services: Get Attribute Single
Set Attribute Single

15.6.2 Class Attributes

#	Access	Name	Type	Value	Description
1	Get	Revision	UINT	0001h	Revision 1
2	Get	Max Instance	UINT	0001h	Max instance number

15.6.3 Instance Attributes

#	Access	Name	Type	Value	Description
1	Get/Set	Acknowledge Timer	UINT	16	Time (in ms) to wait for acknowledge before re-sending
2	Get/Set	Retry Limit	USINT	1	Number of ACK timeouts before retry limit reached event
3	Get/Set	Producing connection Instance	UINT	4	Connection instance, which contains the path of the producing I/O application object, which will be notified of Ack Handler events.
4	Get	Ack List Size	Byte	-	Max. no. of members in Ack list. 0 = Dynamic
5	Get	Ack List	Array of USINT	N/A	List of active connection instance which are receiving Acks.
6	Get	Data with Ack Path List Size	Byte	-	Max. no. of members in Data with Ack Path List. 0 = Dynamic
7	Get	Data with Ack Path List	Array of USINT	N/A	List of connection instance/consuming application object pairs.

Note: Instance 1 is created when using an ACK:ed COS/Cyclic connection.

15.7 Diagnostic Object, Class AAh

15.7.1 General Information

Object Description

This vendor specific object provides diagnostic information from the module.

Implemented Services

Class services: Get Attribute All

Instance services: Get Attribute Single

15.7.2 Class Attributes

#	Access	Name	Type	Value	Description
1	Get	Revision	UINT	0001h	Revision 1

15.7.3 Instance Attributes, Instance 01h

#	Access	Name	Type	Description
01h	Get	Module serial number	UDINT	Serial number
04h	Get	Module Software version	UINT	DeviceNet Interface software version
0Fh	Get	Input I/O Size ^a	UINT	IO Size In
11h	Get	Input Total Size	UINT	Total size of Input Data area (I/O + Parameter Data)
12h	Get	Output I/O Size ^a	UINT	IO Size Out
14h	Get	Output Total Size	UINT	Total size of Output Data area (I/O + Parameter Data)

a. See "IO Sizes" on page 27.

15.8 Parameter Data Input Mapping Object, Class B0h

15.8.1 General Information

Object Description

This object can be used to access input data acyclically, and is set up dynamically based on the Parameter Data Mailbox initialization (see “Parameter Data Initialization (Explicit Data)” on page 82).

See also...

- “Data Representation on DeviceNet” on page 20
- “Parameter Data Output Mapping Object, Class B1h” on page 80
- “Fieldbus Settings” on page 27
- “Parameter Data Initialization (Explicit Data)” on page 82

Supported Services

Class services: Get Attribute All

Instance services: Get Attribute Single

15.8.2 Class Attributes

#	Access	Name	Type	Value	Description
1	Get	Revision	UINT	0001h	Revision 1

15.8.3 Instance Attributes, Instance 01h

Each attribute corresponds to a block of Input Data. Note that the size and location of each block must be specified using the Anybus Configuration Manager.

For more information, see “Mapping Input Parameter Data to DeviceNet” on page 83.

#	Access	Name	Type	Description
01h	Get	Data	Array of USINT	Mapped block if Input Data
02h	Get	Data	Array of USINT	Mapped block if Input Data
02h	Get	Data	Array of USINT	Mapped block if Input Data
02h	Get	Data	Array of USINT	Mapped block if Input Data
02h	Get	Data	Array of USINT	Mapped block if Input Data
02h	Get	Data	Array of USINT	Mapped block if Input Data
...
32h	Get	Data	Array of USINT	Mapped block if Input Data

15.9 Parameter Data Output Mapping Object, Class B1h

15.9.1 General Information

Object Description

This object can be used to access output data acyclically, and is set up dynamically based on the Parameter Data Mailbox initialization (see “Parameter Data Initialization (Explicit Data)” on page 82).

See also...

- “Data Representation on DeviceNet” on page 20”
- “Parameter Data Input Mapping Object, Class B0h” on page 79
- “Fieldbus Settings” on page 27
- “Parameter Data Initialization (Explicit Data)” on page 82

Supported Services

Class services: Get Attribute All

Instance services: Get Attribute Single
 Set Attribute Single

15.9.2 Class Attributes

#	Access	Name	Type	Value	Description
1	Get	Revision	UINT	0001h	Revision 1

15.9.3 Instance Attributes, Instance 01h

Each attribute corresponds to a block of output data. Note that the size and location of each block must be specified using the Anybus Configuration Manager.

For more information, see “Mapping Output Parameter Data to DeviceNet” on page 85.

#	Access	Name	Type	Description
01h	Get/Set	Data	Array of USINT	Mapped block of Output Data
02h	Get/Set	Data	Array of USINT	Mapped block of Output Data
03h	Get/Set	Data	Array of USINT	Mapped block of Output Data
04h	Get/Set	Data	Array of USINT	Mapped block of Output Data
05h	Get/Set	Data	Array of USINT	Mapped block of Output Data
06h	Get/Set	Data	Array of USINT	Mapped block of Output Data
...
32h	Get/Set	Data	Array of USINT	Mapped block of Output Data

16. Advanced Fieldbus Configuration

16.1 General

The fieldbus interface of the gateway consists of an embedded Anybus-S communication interface. Normally, the Anybus-S configuration settings are set up automatically by the gateway. However, advanced users can configure the Anybus-S card for specific features. This chapter assumes that the reader is familiar with the Anybus-S and its application interface. For more information about the Anybus-S platform, consult the Anybus-S Parallel Design Guide.

The standard initialization parameters are determined by the sub-network configuration. Information about the amount of input and output data used for sub-network communication is used by ACM to create the configuration message that sets the sizes of the input and output data areas in the Dual Port RAM of the embedded Anybus-S interface. It is possible to add fieldbus specific mailbox messages to customize the initialization. This is done in the Mailbox Editor, see below.

(A mailbox message is a HMS specific command structure used for low-level communication with an Anybus-S interface. Consult the Anybus-S Parallel Design Guide and the fieldbus appendix for the desired fieldbus for further information.)

16.2 Mailbox Editor

To add a mailbox message to the configuration, right-click on “EndInit” and select “Insert New Mailbox”.

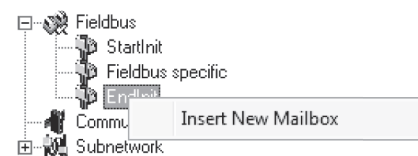

A mailbox message consists of a Header section and a data section where the Header consists of 16 words (32 bytes) and the data section consists of up to 128 words (256 bytes). All fields are editable except the Message information field that is fixed to 0x4002, which means that only fieldbus specific mailbox messages can be entered here.

The mailbox message is presented as two columns; one contains header information (A), the other one contains the message data (B).

To add message data, simply change the Data size parameter in the header column (A), and the corresponding number of bytes will appear in the message data column (B).

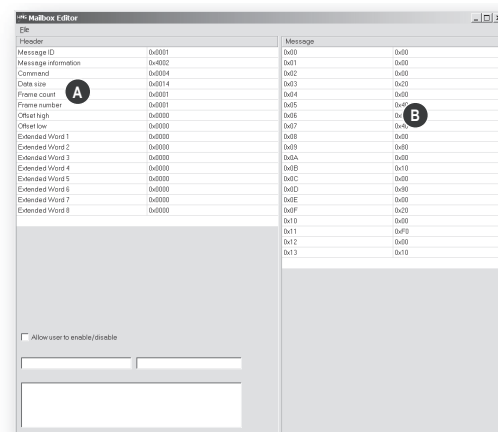

For more information about fieldbus specific mailbox messages, consult the separate Anybus-S Fieldbus Appendix for the fieldbus you are using. For general information about the Anybus-S platform, consult the Anybus-S Design Guide.

A. Parameter Data Initialization (Explicit Data)

A.1 General

The portion of the Input and Output Data declared as Parameter Data cannot be accessed from the network unless it has been properly initialized.

The purpose of this procedure is to specify which data blocks in the Input and Output Data areas to associate with the instance attributes in the Parameter Data Input Mapping Object and the Parameter Data Output Mapping Object.

To achieve this, it is required to set up two mailbox messages in the Mailbox Editor of the Anybus Configuration Manager.

For more information about the Mailbox Editor, see “Mailbox Editor” on page 81.

A.2 Add a Mailbox Message

To add a mailbox message to the configuration, right-click on “EndInit” and select “Insert New Mailbox”.

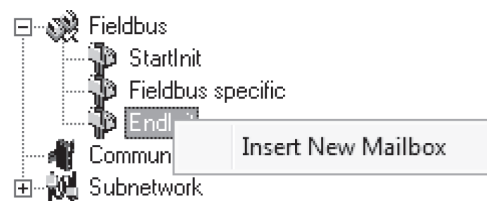

This causes the following window to appear:

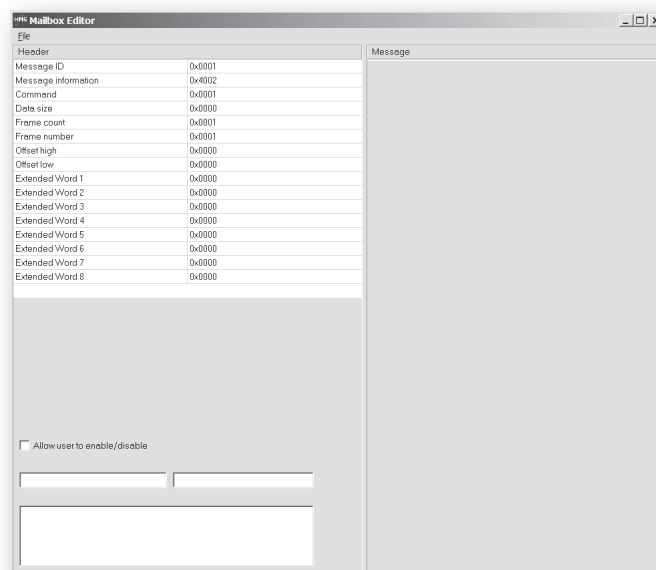

This window, a.k.a. the Mailbox Editor, will be used in the examples later in this chapter.

A.3 Mapping Input Parameter Data to DeviceNet

Example

In the following example, a total of 160 bytes of data will be mapped to the Parameter Data Input Mapping Object. The data is made up of 5 separate data blocks, each associated with a particular instance attribute.

To achieve this, perform the following steps:

1. Add a new mailbox message to the configuration (see “Add a Mailbox Message” on page 82).
2. Change the “Command”-value in the mailbox header to 0004h.
3. Adjust the “Data Size”-value in the mailbox header (left column). In this example, the size shall be set to 20 (0014h), since each mapped attribute occupies 4 bytes of mailbox data.
4. Specify the mapping locations for the attributes in the mailbox data section. As mentioned above, each mapping entry needs 4 bytes; two bytes specifying the offset¹ of the data block, followed by two bytes which specify the length of the data block. Note that these values must be entered in big endian (Motorola) format.

In this example, this gives us the following mailbox data:

Mailbox Data		Attribute no.	Comments
Location	Data		
0x00	0x00	1	Offset = 0000h Size = 32 bytes
0x01	0x00		
0x02	0x00		
0x03	0x20		
0x04	0x00	2	Offset = 0040h Size = 64 bytes
0x05	0x40		
0x06	0x00		
0x07	0x40		
0x08	0x00	3	Offset = 0080h Size = 16 bytes
0x09	0x80		
0x0A	0x00		
0x0B	0x10		
0x0C	0x00	4	Offset = 0090h Size = 32 bytes
0x0D	0x90		
0x0E	0x00		
0x0F	0x20		
0x10	0x00	5	Offset = 00F0h Size = 16 bytes
0x11	0xF0		
0x12	0x00		
0x13	0x10		

As shown in the table above, the attributes are numbered in the order they are mapped, i.e. it is possible to rearrange the attribute numbering by physically changing the mapping order in the mailbox data.

5. To save the new mailbox, select “Apply changes” in the “File”-menu.

1. The offset is specified from the start of the parameter data, not from the physical memory location in the Anybus Communicator.

Resulting Attribute Mapping

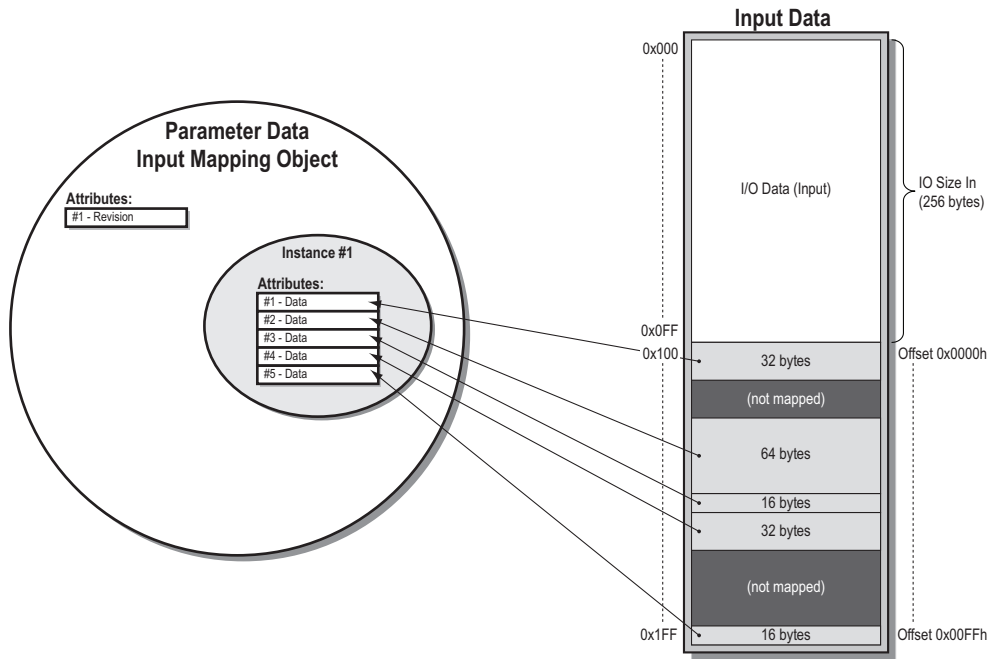

Mailbox Editor Screenshot

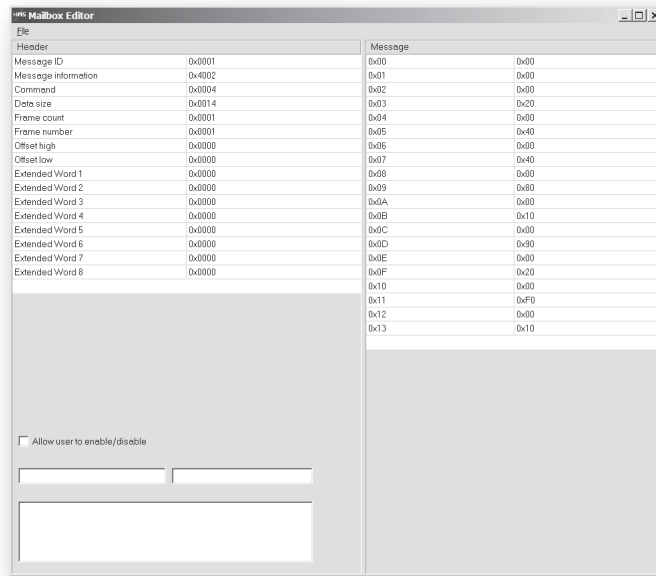

A.4 Mapping Output Parameter Data to DeviceNet

Example

Mapping output data is similar to mapping input data; in the following example, a total of 144 bytes of data will be mapped to the Parameter Data Output Mapping Object. The data is made up of 4 separate blocks, each associated with a particular instance attribute.

To achieve this, perform the following steps:

1. Add a new mailbox message to the configuration (see “Add a Mailbox Message” on page 82).
2. Change the “Command”-value in the mailbox header to 0005h.
3. Adjust the “Data Size”-value in the mailbox header (left column). In this example, the size shall be set to 16 (0010h), since each mapped attribute occupies 4 bytes of mailbox data.
4. Specify the mapping locations for the attributes in the mailbox data section. As mentioned above, each mapping entry needs 4 bytes; two bytes specifying the offset¹ of the data block, followed by two bytes which specify the length of the data block. Note that these values must be entered in big endian (Motorola) format.

In this example, this gives us the following mailbox data:

Mailbox Data		Attribute no.	Comments
Location	Data		
0x00	0x00	1	Offset = 0020h Size = 16 bytes
0x01	0x20		
0x02	0x00		
0x03	0x10		
0x04	0x00	2	Offset = 0050h Size = 32 bytes
0x05	0x50		
0x06	0x00		
0x07	0x20		
0x08	0x00	3	Offset = 0070h Size = 32 bytes
0x09	0x70		
0x0A	0x00		
0x0B	0x20		
0x0C	0x00	4	Offset = 00D0h Size = 64 bytes
0x0D	0xD0		
0x0E	0x00		
0x0F	0x40		

As shown in the table above, the attributes are numbered in the order they are mapped, i.e. it is possible to rearrange the attribute numbering by physically changing the mapping order in the mailbox data.

5. To save the new mailbox, select “Apply changes” in the “File”-menu.

1. The offset is specified from the start of the Parameter Data, not from the physical memory location in the Anybus Communicator.

Resulting Attribute Mapping

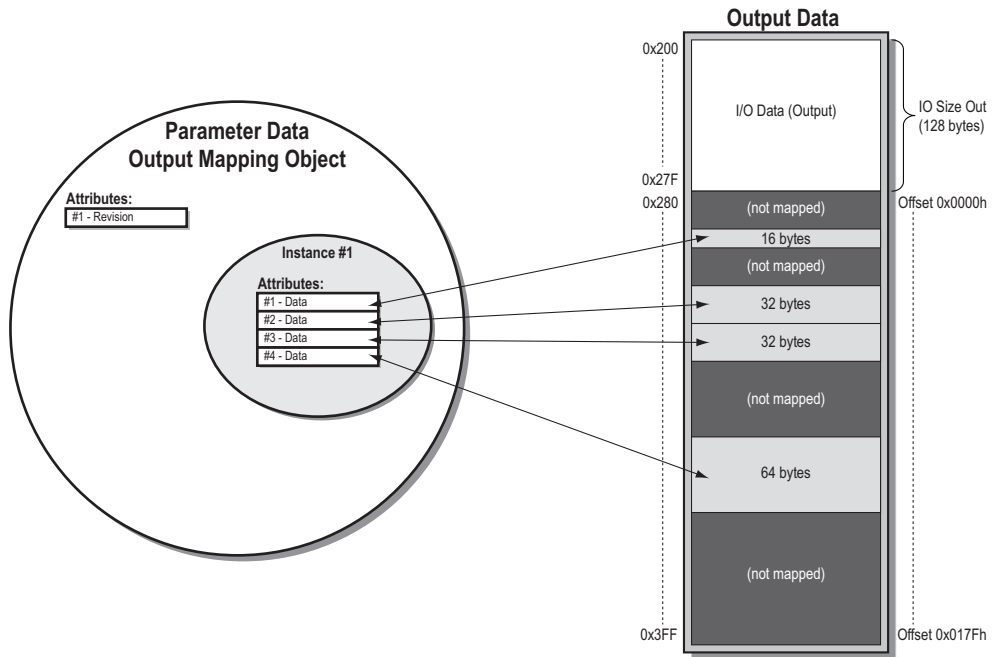

Mailbox Editor Screenshot

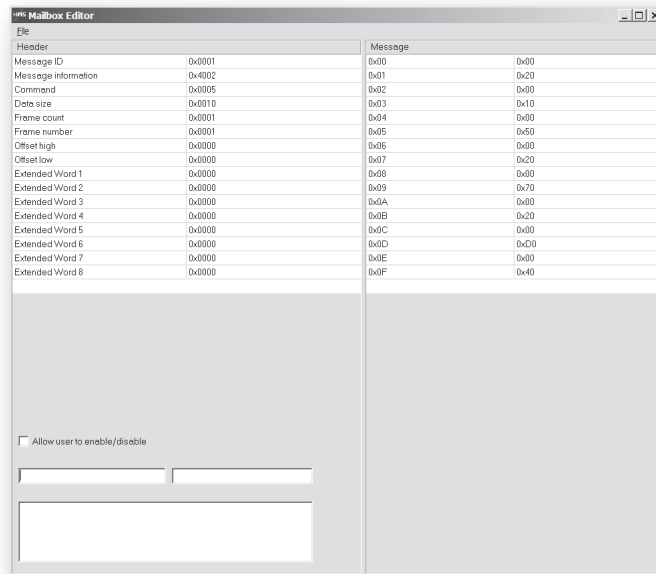

B. Connector Pin Assignments

B.1 DeviceNet Connector

Pin	Signal	Description
1	V -	DeviceNet bus power, negative supply voltage
2	CAN L	Can L bus line
3	Shield	Cable shield
4	CAN H	CAN H bus line
5	V +	DeviceNet bus power, positive supply voltage

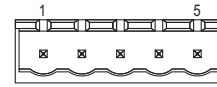

B.2 Power Connector

Pin	Description
1	+24 VDC
2	GND

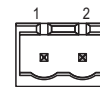

Notes:

- Use 60/75 or 75 °C copper (Cu) wire only.
- Minimum terminal tightening torque: 5–7 lb-in (0.5–0.8 Nm).

B.3 PC Connector

Configuration Cable Wiring

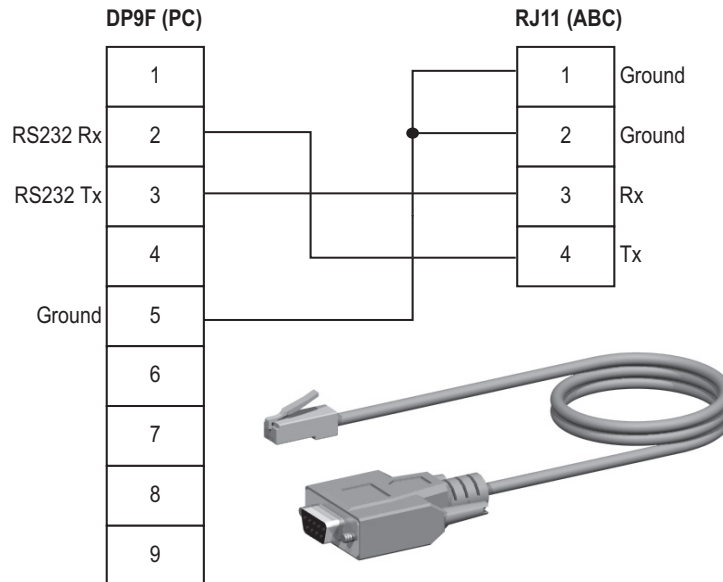

RJ11 (4P4C modular)¹ : ABC

Pin	Description
1	Signal ground
2	
3	RS232 Rx (Input)
4	RS232 Tx (Output)

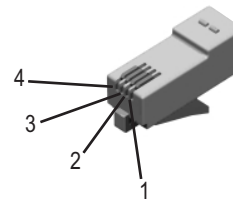

DB9F : PC

Pin	Description
1	-
2	RS232 Rx (Input)
3	RS232 Tx (Output)
4	-
5	Signal Ground
6 - 9	-

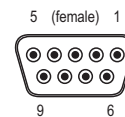

1. The RJ11 (4P4C modular) is sometimes referred to as an RJ9.

B.4 Subnetwork Interface

B.4.1 General Information

The subnetwork interface provides for RS232, RS422 and RS485 communications. Depending on the configuration specified in the Anybus Configuration Manager, different signals are activated in the subnetwork connector.

B.4.2 Bias Resistors (RS485 Only)

When idle, RS485 enters an indeterminate state, which may cause the serial receivers to pick up noise from the serial lines and interpret this as data. To prevent this, the serial lines should be forced into a known state using pull-up and pull-down resistors, commonly known as bias resistors.

The bias resistors form a voltage divider, forcing the voltage between the differential pair to be higher than the threshold for the serial receivers, typically >200 mV.

Note that bias resistors shall only be installed on one node; installing bias resistors on several nodes may compromise the signal quality on the network and cause transmission problems.

B.4.3 Termination (RS485 & RS422 Only)

To avoid reflections on the serial lines, it is important to properly terminate the subnetwork by placing termination resistors between the serial receivers near the end nodes.

The resistor value should ideally match the characteristic impedance of the cable, typically 100–120 Ω .

B.4.4 Connector Pinout (DB9F)

Pin	Description	RS232	RS422	RS485
1	+5 V Output (100 mA max)	✓	✓	✓
2	RS232 Rx	✓		
3	RS232 Tx	✓		
4	(reserved)			
5	Signal Ground ^a	✓	✓	✓
6	RS422 Rx +		✓	
7	RS422 Rx -		✓	
8	RS485 + / RS422 Tx+		✓	✓
9	RS485 - / RS422 Tx-		✓	✓
(housing)	Cable Shield	✓	✓	✓

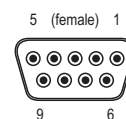

- a. Connecting this signal directly to Protective Earth (PE) of other nodes may, in case of grounding loops etc., cause damage to the on-board serial transceivers. It is therefore generally recommended to connect it only to Signal Ground (if available) of other nodes.

B.4.5 Typical Connection (RS485)

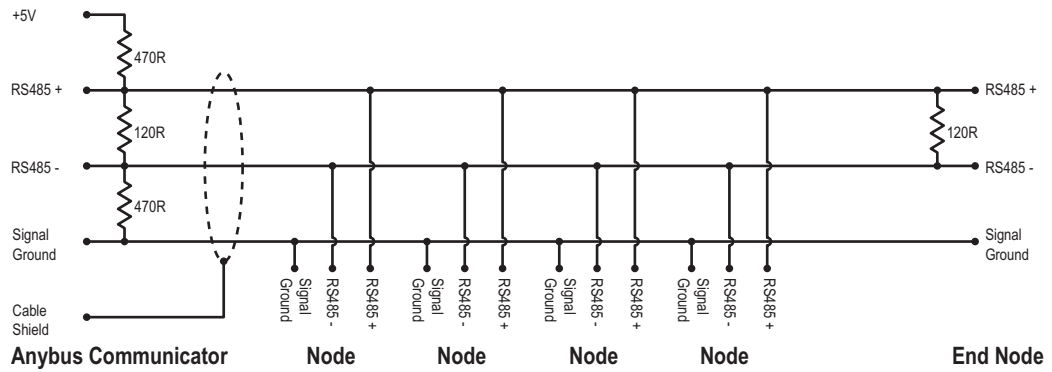

B.4.6 Typical Connection (RS422 & 4-Wire RS485)

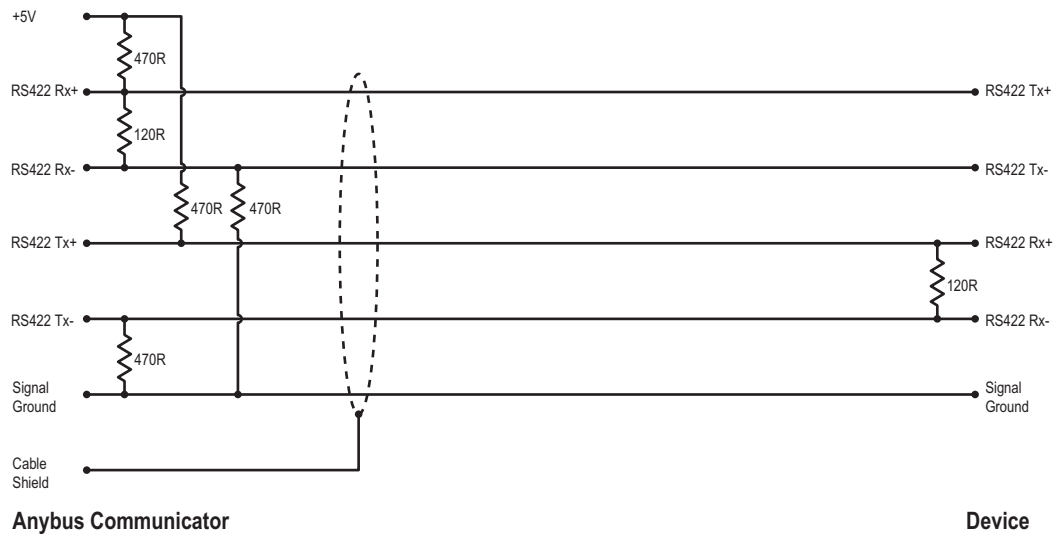

Note: Bias resistors are normally not needed on RS422, but may be required when using 4-wire RS485.

B.4.7 Typical Connection (RS232)

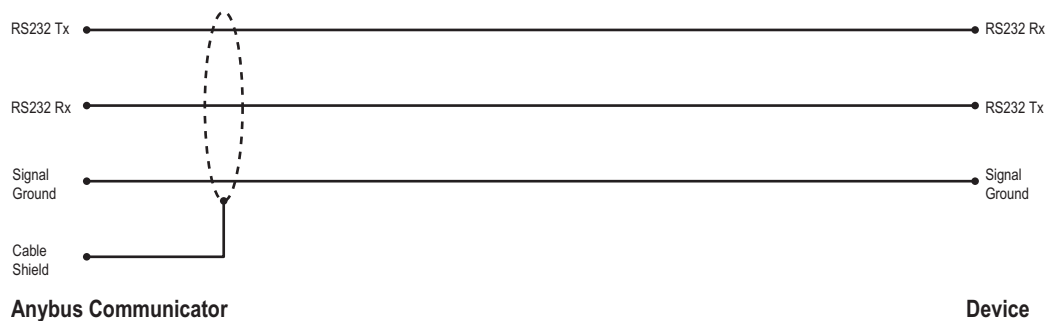

C. Technical Specification

C.1 Mechanical Properties

Housing

Plastic housing with snap-on connection to DIN-rail, protection class IP20.

Dimensions (L x W x H)

120 mm x 75 mm x 27 mm (4.72" x 2.95" x 1.06")

C.2 Electrical Characteristics

Power Supply

Power: 24 VDC \pm 10%

Power Consumption

Maximum power consumption is 280 mA on 24 VDC. Typically around 100 mA.

C.3 Environmental Characteristics

Relative Humidity

The product is designed for a relative humidity of 0 to 95 % non-condensing.

Temperature

Operating: 0 °C to +55 °C
Non-operating: -25 °C to +85 °C

C.4 Regulatory Compliance

EMC Compliance (CE)



This product is in accordance with the EMC directive 89/336/EEC, with amendments 92/31/EEC and 93/68/EEC through conformance with the following standards:

- **EN 50082-2 (1993)**
EN 55011 (1990) Class A
- **EN 61000-6-2 (1999)**
EN 61000-4-3 (1996) 10 V/m
EN 61000-4-6 (1996) 10 V/m (all ports)
EN 61000-4-2 (1995) ± 8 kV air discharge, ± 4 kV contact discharge
EN 61000-4-4 (1995) ± 2 kV power port, ± 1 kV other ports
EN 61000-4-5 (1995) ± 0.5 kV power ports (DM/CM), ± 1 kV signal ports

UL/c-UL Compliance



IND: CONT. EQ.
FOR HAZ LOC.
CL I, DIV 2
GP A,B,C,D
TEMP
CODE
E203225

WARNING - EXPLOSION HAZARD - SUBSTITUTION OF ANY COMPONENTS MAY IMPAIR SUITABILITY FOR CLASS I, DIVISION 2.

WARNING - EXPLOSION HAZARD - WHEN IN HAZARDOUS LOCATIONS, TURN OFF POWER BEFORE REPLACING OR WIRING MODULES.

WARNING - EXPLOSION HAZARD - DO NOT DISCONNECT EQUIPMENT UNLESS POWER HAS BEEN SWITCHED OFF OR THE AREA IS KNOWN TO BE NON-HAZARDOUS.

ATTENTION – RISQUE D'EXPLOSION – LE REMPLACEMENT DE TOUT COMPOSANTS INVALIDE LA CERTIFICATION CLASS I, DIVISION 2.

ATTENTION – RISQUE D'EXPLOSION – EN ZONE EXPLOSIVE, VEUILLEZ COUPER L'ALIMENTATION ÉLECTRIQUE AVANT LE REMPLACEMENT OU LE RACCORDEMENT DES MODULES.

ATTENTION – RISQUE D'EXPLOSION – NE PAS DÉCONNECTER L'ÉQUIPEMENT TANT QUE L'ALIMENTATION EST TOUJOURS PRÉSENTE OU QUE LE PRODUIT EST TOUJOURS EN ZONE EXPLOSIVE ACTIVE.

Additional installation and operating instructions

- Max Ambient Temperature: 55 °C (for Hazloc environments)
- Field wiring terminal markings (wire type (Cu only, 14–30 AWG)).
- Use 60/75 or 75 °C copper (Cu) wire only.
- Terminal tightening torque must be 5–7 lb-in (0.5–0.8 Nm).
- Use in overvoltage category 1 pollution degree 2 environment.
- Installed in an enclosure considered representative of the intended use.
- Secondary circuit intended to be supplied from an isolating source and protected by overcurrent protective devices installed in the field sized per the following:

Control circuit wire size		Maximum protective device rating
AWG	mm ²	Amperes
22	0.32	3
20	0.52	5
18	0.82	7
16	1.3	10
14	2.1	20
12	3.3	25

Galvanic isolation on sub-network interface

- EN 60950-1 (2001)
 - Pollution Degree 2
 - Material Group IIIb
 - 250 V_{RMS} or 250 VDC working voltage
 - 500 V secondary circuit transient rating

CIP Product Compliance



D. Troubleshooting

Problem	Solution
Problem during configuration Upload / Download. The Config Line "LED" turns red in ACM.	<ul style="list-style-type: none"> Serial communication failed. Try again
The serial port seems to be available, but it is not possible to connect to the gateway	<ul style="list-style-type: none"> The serial port may be in use by another application. Exit ACM and close all other applications including the ones in the system tray. Try again Select another serial port Try again
Poor performance	<ul style="list-style-type: none"> Right click "sub-network" in the Navigation window and select "sub-network Status" to see status / diagnostic information about the sub-network. If the gateway reports very many retransmissions, check your cabling and/or try a lower baud rate setting for the sub-network (if possible). Is the Subnet Monitor in ACM active? The sub-network monitor has a negative influence on the overall performance of the gateway, and should only be used when necessary. Is the Node Monitor in ACM active? The node monitor has a negative influence on the overall performance of the gateway, and should only be used when necessary.
No sub-network functionality	<ul style="list-style-type: none"> Use the "Data logger"-functionality to record the serial data communication on the sub-network. If no data is being transmitted, check the configuration in ACM. If no data is received, check the sub-network cables. Also verify that the transmitted data is correct.