

User Manual

Anybus[®] X-gateway CANopen Modbus RTU

Doc: HMSI-186-86
Rev. 2.10



HALMSTAD • CHICAGO • KARLSRUHE • TOKYO • BEIJING • MILANO • MULHOUSE • COVENTRY • PUNE • COPENHAGEN

HMS Industrial Networks
Mailing address: Box 4126, 300 04 Halmstad, Sweden
Visiting address: Stationsgatan 37, Halmstad, Sweden

E-mail: info@hms-networks.com
www.anybus.com

Important User Information

This document is intended to provide a good understanding of the functionality offered by the Anybus X-gateway CANopen - Modbus RTU.

The reader of this document is expected to be familiar with high level software design, and communication systems in general. The use of advanced CANopen specific functionality may require in-depth knowledge in CANopen networking internals and/or information from the official CANopen specifications. In such cases, the people responsible for the implementation of this product should either obtain the CANopen specification to gain sufficient knowledge or limit their implementation in such a way that this is not necessary. Also knowledge of Modbus RTU is expected.

Liability

Every care has been taken in the preparation of this manual. Please inform HMS Industrial Networks AB of any inaccuracies or omissions. The data and illustrations found in this document are not binding. We, HMS Industrial Networks AB, reserve the right to modify our products in line with our policy of continuous product development. The information in this document is subject to change without notice and should not be considered as a commitment by HMS Industrial Networks AB. HMS Industrial Networks AB assumes no responsibility for any errors that may appear in this document.

There are many applications of this product. Those responsible for the use of this device must ensure that all the necessary steps have been taken to verify that the applications meet all performance and safety requirements including any applicable laws, regulations, codes, and standards.

HMS Industrial Networks AB will under no circumstances assume liability or responsibility for any problems that may arise as a result from the use of undocumented features, timing, or functional side effects found outside the documented scope of this product. The effects caused by any direct or indirect use of such aspects of the product are undefined, and may include e.g. compatibility issues and stability issues.

The examples and illustrations in this document are included solely for illustrative purposes. Because of the many variables and requirements associated with any particular implementation, HMS Industrial Networks AB cannot assume responsibility for actual use based on these examples and illustrations.

Intellectual Property Rights

HMS Industrial Networks AB has intellectual property rights relating to technology embodied in the product described in this document. These intellectual property rights may include patents and pending patent applications in the US and other countries.

Trademark Acknowledgements

Anybus ® is a registered trademark of HMS Industrial Networks AB. All other trademarks are the property of their respective holders.



WARNING: This is a class A product. In a domestic environment this product may cause radio interference in which case the user may be required to take adequate measures.

ESD Note: This product contains ESD (Electrostatic Discharge) sensitive parts that may be damaged if ESD control procedures are not followed. Static control precautions are required when handling the product. Failure to observe this may cause damage to the product.

WARNING: DO NOT REMOVE OR REPLACE USB CONNECTOR WHILE CIRCUIT IS LIVE UNLESS THE AREA IS KNOWN TO BE FREE OF IGNITIBLE CONCENTRATIONS OF FLAMMABLE GASES OR VAPORS.

Table of Contents

Important User Information	
<i>Liability</i>	1
<i>Intellectual Property Rights</i>	1
<i>Trademark Acknowledgements</i>	1
Preface	About This Document
	Related Documents..... 1
	Document History 1
	Conventions & Terminology..... 1
	Sales and Support 1
Chapter 1	Anybus X-gateway CANopen - Modbus RTU
	Introduction 2
	Features 3
	Functional Overview..... 4
	Data Exchange..... 4
Chapter 2	About the Anybus X-gateway CANopen
	External View..... 6
	Status LEDs 7
	Primary Network 8
	<i>Modbus RTU Connector Pinout</i> 8
	<i>Configuration Switches</i> 8
	Secondary Network..... 10
	<i>CANopen Connector</i> 10
	<i>Configuration Switches</i> 10
	USB Connector..... 11
	<i>Power Connector</i> 11
	Hardware Installation..... 12
	CANopen Electronic Data Sheet (EDS) 13
Chapter 3	Getting Started
Chapter 4	CANopen Fieldbus Functionality
	Supported Fieldbus Services..... 15
Chapter 5	Configuration
	CANopen Master/Slave Configuration..... 17
	Secondary CANopen Network Configuration 18
	<i>LSS Routine</i> 18

Configuration of the Modbus RTU Interface..... 19

- Data Exchange*..... 19
- Modbus Exceptions*..... 19
- Coil & Register Map*..... 20
- Modbus Diagnostics* 21
- Network Termination* 21
- Configuration* 21

Enabling Data Exchange..... 22

Chapter 6 CANopen Module Specification

NMT State Machine..... 23

Data Exchange..... 24

- Control Word* 25
- Status Word* 26
- Example*..... 28
- PDO Functionality*..... 29

LSS Services..... 30

Error Control 31

- Heartbeat Mechanism* 31
- Node Guarding*..... 31
- Emergency Object (EMCY)*..... 31

Chapter 7 CANopen Supported Objects

Static Data Types..... 32

Communication Profile Area..... 32

- DS301 Communication Profile Objects*..... 32
- Configuration Manager* 34
- Network Management Objects* 35

Vendor Specific Objects..... 40

- Transmit Buffer* 41
- Receive Buffer*..... 42
- I/O Buffer Addresses and Object Dictionary Indices Relation* 43
- General Fieldbus Parameters*..... 44
- Modbus RTU Specific Parameters*..... 44

Appendix A Technical Specification

Protective Earth (PE) Requirements..... 45

Power Supply 45

Environmental Specification 45

- Temperature*..... 45
- Relative Humidity*..... 45

EMC (CE) Compliance 46

UL and ATEX Certification 46

Appendix B Status LED Timing Diagrams

Appendix C CANopen Emergency Codes

Appendix D Enabling Data Exchange

P. About This Document

For more information, documentation etc., please visit www.anybus.com

P.1 Related Documents

Document	Author
CiA Draft Standard 301 v4.2	CAN in Automation
CiA Draft Standard Proposal 302 Part 1-5	CAN in Automation
Modbus application specification	Modbus-IDA
Modbus over serial line specification and implementation guide	Modbus.org

P.2 Document History

Revision List

Revision	Date	Author(s)	Chapter(s)	Description
1.00	2010-01-17	KeL	-	First official release
1.01	2011-02-04	KeL	-	Minor corrections and updates
1.02	2011-03-24	KeL	3. 6. 7	Minor corrections
2.00	2011-12-01	KeL	All	General rewrite
2.01	2013-01-11	KeL	5, 6	Minor updates
2.10	Nov 2014	SDa	Multiple	Removed references to PORT configuration software

P.3 Conventions & Terminology

The following conventions are used throughout this manual:

- Numbered lists provide sequential steps
- Bulleted lists provide information, not procedural steps
- The terms ‘Anybus’ or ‘module’ refers to the Anybus X-gateway module.
- Hexadecimal values are written in the format NNNNh, where NNNN is the hexadecimal value.
- A byte always consists of 8 bits

P.4 Sales and Support

For general contact information and support, please refer to the contact and support pages at www.anybus.com

1. Anybus X-gateway CANopen - Modbus RTU

1.1 Introduction

The Anybus X-gateway CANopen is a series of network gateways, used to provide a seamless connection between a primary fieldbus/Ethernet network and a secondary CANopen sub-network. The gateway enables the master of the fieldbus/Ethernet network to exchange data to and from the secondary CANopen sub-network. This makes it possible to integrate CANopen devices into almost any other PLC system and their supported networks.

The gateway is based on patented Anybus technology, a proven industrial communication solution used all over the world by leading manufacturers of industrial automation products. Each module offers CANopen master/slave connectivity to one of these industrial networks: EtherCAT, PROFIBUS DPV1, DeviceNet, ControlNet, CANopen, Modbus RTU, EtherNet/IP, PROFINET IO (both RT and IRT) or Modbus TCP.

No proprietary configuration software is needed, though dedicated configuration tools are required when setting up the actual industrial network communications. Any standard CANopen configuration tool can be used to configure the CANopen interface.

The gateways transmit I/O data transparently between the two networks. I/O data from the primary fieldbus/Ethernet network is written into CANopen objects that can be mapped into CANopen PDOs or read via CANopen SDOs and vice versa.

The gateway, described in this manual, connects a Modbus RTU network with a CANopen network. The module acts as a Modbus RTU adapter/slave on the primary network and can act either as a slave or as a master on the sub-network, transmitting I/O data between the networks.

The Modbus RTU adapter/slave interface, connected to the primary network, is configured with a standard device description file (GSD/EDS) and the standard configuration tool of the master of that network. No programming is required.

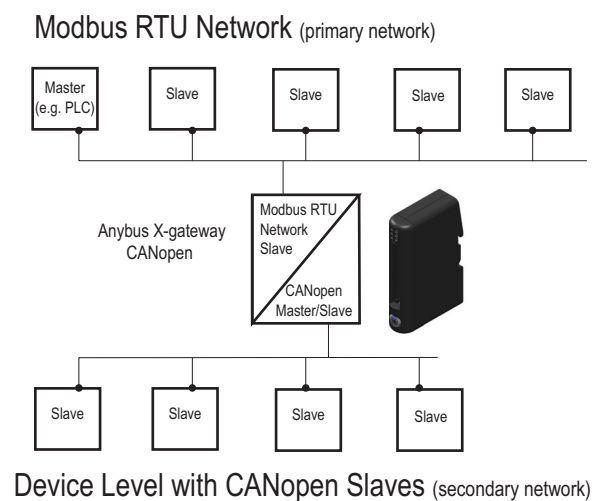

IMPORTANT: This product acts as a gateway between two industrial networks. One network is a CANopen sub-network, on which the module either acts as a master or as a slave, depending on configuration. Using the module, this CANopen sub-network is connected to and can exchange data with another kind of industrial network, e.g. PROFIBUS or EtherNet/IP, connected to the module. To make it easier to distinguish the two networks from each other, the CANopen sub-network will be called the secondary network throughout the manual. The other network will be called the primary network. In the product that this manual describes, the primary network is Modbus RTU and the secondary network is CANopen.

1.2 Features

The Anybus CANopen X-gateway acts as an intelligent link between two industrial networks. On the secondary CANopen sub-network, it can perform either as a master (manager) or as a slave (server), depending on configuration, while it always will act as a slave on the primary fieldbus/Ethernet side. The implementation is based on HMS NP30 network microprocessor and is certified by CAN in Automation (CIA) for full conformance to the CANopen DS 301 v4.0.2 standard.

CANopen (sub-network, secondary network)

- CANopen master (manager) and slave functionality
- Connects up to 126 CANopen slave nodes
- Complies to the CANopen communication profile DS301 4.2 and DSP302 (part 1-5)
- Supports cyclic and acyclic synchronous as well as COS (change of state) PDO message types
- 20 kbps... 1 Mbps operation
- Heartbeat and node guarding mechanisms
- Sync objects
- 128 receive and 128 transmit PDOs available
- Up to 510 bytes of cyclic data in each direction (PDO)

Modbus RTU Features (primary network)

- Modbus RTU compliant, passive slave node operation
- Modbus diagnostics
- Up to 256 Modbus registers in each direction
- RS485 or RS232 operation
- Baud rates from 1200 bps to 57600 bps
- On-board configuration switches

1.3 Functional Overview

Internally, the X-gateway consists of an intelligent gateway platform, an Anybus CANopen interface¹ and an Anybus Modbus RTU interface. The CANopen interface and the Anybus Modbus RTU interface are interconnected through the intelligent gateway platform, which basically forwards data from one network to the other and vice versa as shown below. This design allows almost any industrial network to be connected to a CANopen master or a slave on a separate CANopen network.

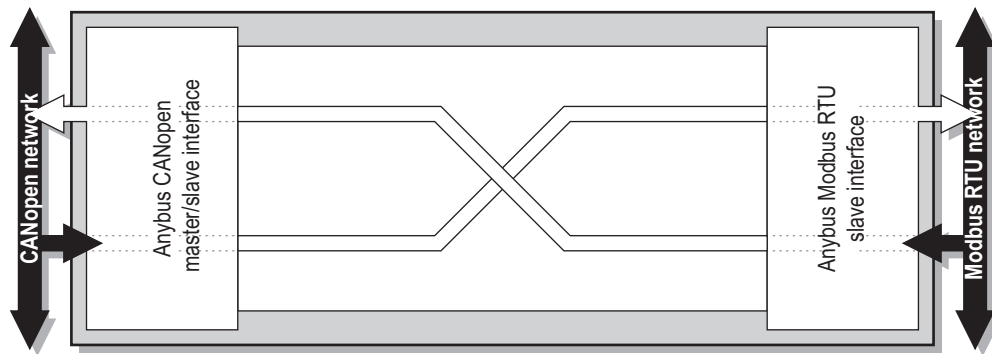

1.4 Data Exchange

Each of the two network interfaces exchanges data on its network through two buffers. The gateway forwards the data between these buffers as shown below. Note that this process is separated from the network data exchange. While the gateway ensures data consistency (where applicable), it does not feature any built-in mechanisms for synchronisation between the primary Modbus RTU network and the secondary CANopen network.

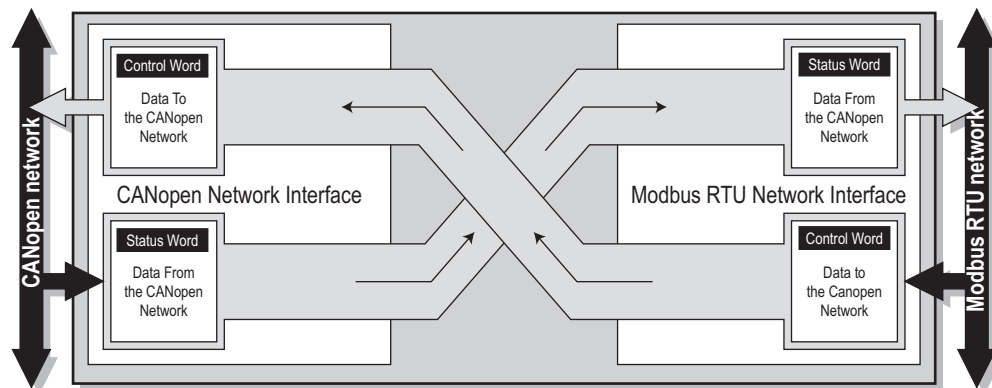

Each buffer holds up to 512 bytes of data, where the first two bytes always are used for control/status information. The remaining 510 bytes gives the theoretical upper limit for the number of data bytes that can be exchanged in each direction. Please note that the actual number of bytes that can be exchanged is highly network dependent.

Through the dedicated control word, the master on the primary Modbus RTU network starts/stops the exchange of data on the secondary CANopen (the sub-network). It can also reset the gateway if needed.

1. When it is started the first time, the Anybus X-gateway is set as slave on the secondary network. This can be changed during configuration, see "Enabling Data Exchange" on page 49. The module will remember its setting when restarted.

The master on the primary Modbus RTU network can see the status of the secondary CANopen network in the corresponding status word.

The amount of data that shall be exchanged, and the use of the control- and status functionality, is specified separately for each application. This means that even though up to 510 bytes of data can be forwarded to an interface, the amount of data that will actually be exchanged on the primary Modbus RTU network is determined by settings of the secondary CANopen network, with consideration taken to the limits of the interface.

The available control- and status functionality is described in “Data Exchange” on page 24. Also note that the terminology and definitions used for different types of data vary greatly between different networking systems. All data transported through the Anybus X-gateway CANopen is fast, cyclic data and is simply referred to as ‘I/O Data’ in this document.

2. About the Anybus X-gateway CANopen

2.1 External View

A: Status LEDs

See also...

- “Status LEDs” on page 7

B: Primary Network Connectors and Switches

This connector (connectors) and, if available, these switches are used to connect the Anybus X-gateway CANopen module to the primary Modbus RTU network and to configure that interface. They are described in “Primary Network” on page 8.

C: USB connector

This connector simulates a COM-port, used for software upgrade of the module. Please note that this connector can not be used for configuration of the module.

See also...

- “Secondary Network” on page 10

D: CANopen Connector

This connector is used to connect the gateway to the secondary CANopen network.

See also...

- “CANopen Connector” on page 10

E: Power Connector

This connector is used to apply power to the gateway.

See also...

- “Power Connector” on page 11

F: DIN-rail Connector

The DIN-rail mechanism connects the gateway to PE (Protective Earth).

See also...

- “Hardware Installation” on page 12

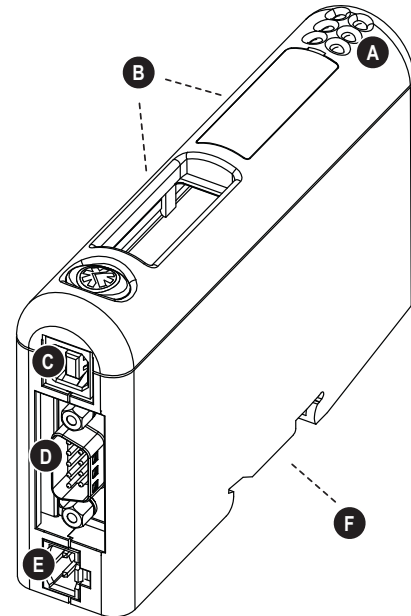

2.2 Status LEDs

The status LEDs on the front indicate the status of the module as shown in the table below. Their behavior is described in “Status LED Timing Diagrams” on page 47

Status LEDs 1 - 4 indicate the status of the primary Modbus RTU network and status LEDs 5 - 6 indicate the status of the secondary CANopen (sub)network and the device.

#	State	Status
1 (Bus Error)	Off	Normal operation or not initialized
	Red	Bus error
2 (Bus Ready)	Off	Not initialized
	Green	Bus ready
	Red	Bus timeout error
3 (Processing)	Off	No query is currently being processed
	Flashing green	Processing query
4 (HW Settings Status)	Off	Using switch settings, normal operation
	Red	Not configured. Operating at 19200 bps Will only respond to broadcast messages
5 - CANopen sub network status ^a	Off	Power off
	Flickering green/red	The LSS services are in progress
	Blinking green	Preoperational state
	Single flash, green	Stopped state
	On, green	Operational state
	Blinking red	Configuration error
	Single flash, red	Warning limit reached in CAN controller, e.g. bad or no signal on CANopen network
	Double flash, red	Error control event
	Triple flash, red	Sync error
	Quadruple flash, red	Data communication timeout
	Red	Bus off
6 - Device status	Off	Power off
	Blinking green	Bootup
	On, green	Running
	Single flash, red	Initialization error
	Double flash, red	Internal timeout
	Triple flash, red	Hardware failure
	Quadruple flash, red	Invalid switch settings
	On, red	Fatal error

a. This LED shows the status of the secondary CANopen network.

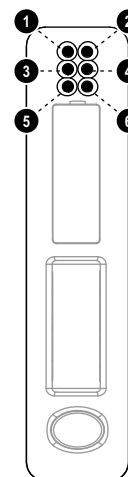

2.3 Primary Network

2.3.1 Modbus RTU Connector Pinout

#	Signal	Meaning
1	-	Not connected
2	TxD	Transmit signal (RS-232)
3	RxD	Receive signal (RS-232)
4	-	Not connected
5	GND	Signal ground
6	+5 V	Power supply
7	B	RS485- (D0) (B-line)
8	A	RS485+ (D1) (A-line)
9	-	Not connected
Housing		Cable shield

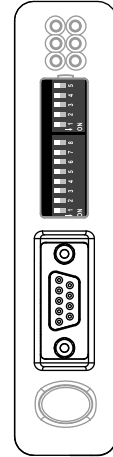
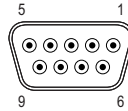

2.3.2 Configuration Switches

The Modbus RTU interface includes configuration switches for Node ID, baud rate, parity and physical interface.

Node Address

Each node on a Modbus RTU network must be assigned a unique node ID. Seven switches are used to set the Modbus node ID of the slave interface in binary form. The switches are read once during start-up, i.e. the gateway must be restarted for any changes to have effect. Highest possible node address is 127.

Example:

In this example, the Modbus node ID will be 42.

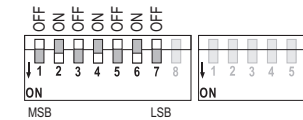
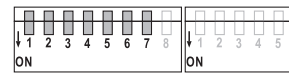

Baud Rate Configuration

The standard baud rate of Modbus RTU is 19.2 kbit/s. The Slave interface does however allow baud rates from 1.2 kbit/s to 57.6 kbit/s to be selected via the baud rate switches. The switches are read once during startup, i.e. the gateway must be restarted for any changes to have effect.

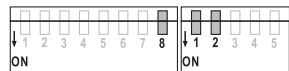

Switch 8	Switch 1	Switch 2	Baud rate (kbit/s)
OFF	OFF	OFF	-
OFF	OFF	ON	1.2
OFF	ON	OFF	2.4
OFF	ON	ON	4.8
ON	OFF	OFF	9.6
ON	OFF	ON	19.2
ON	ON	OFF	38.4
ON	ON	ON	57.6

Example:

In this example, the baud rate will be 1.2 kbit/s.

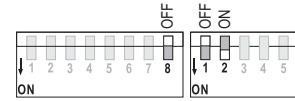

Parity

The Modbus slave interface allows different parity settings to be selected via the parity switches. The switches are read once during startup, i.e. the gateway must be restarted for any changes to have effect.

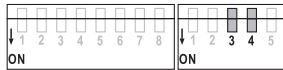

Switch 3	Switch 4	Parity	Stop bits
OFF	OFF	-	-
OFF	ON	None	2
ON	OFF	Even	1
ON	ON	Odd	1

Example:

2 stop bits, no parity (Modbus RTU standard).

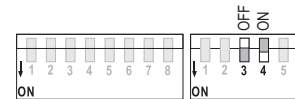

Physical Interface

The slave interface supports RS232 and RS485 communication standards.

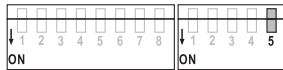

Switch 5	Type
OFF	RS485
ON	RS232

Example:

In this example, the physical interface is set to RS232.

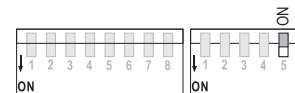

2.4 Secondary Network

2.4.1 CANopen Connector

At the bottom of the module you find the CANopen connector for the secondary network.

Pin no.	Description
2	CAN_L
5	Housing, CAN cable shield
7	CAN_H
1, 4, 8, 9	(reserved)
3, 6	CAN GND

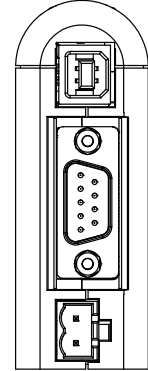
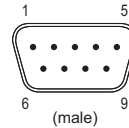

This connector is also used to download the CANopen configuration to the module.

2.4.2 Configuration Switches

The on-board switches on the side of the module are used to set the CANopen node address and operating baud rate for the interface on the secondary network. These settings cannot be changed during runtime, i.e. the gateway must be restarted in order for any changes to have effect.

Note: When these switches have been set, cover them with the switch covers that accompany the module.

Baud Rate

The baud rate is set via switch A:

Switch Setting	Baud Rate (kbit/s)
0	20
1	50
2	125
3	250
4	500
5	800
6	1000
7	Auto ^a
8, 9	Not available

a. The auto baud rate setting should not be used if there is only a small amount of traffic on the bus. This occurs e.g. if the interface is configured as a CANopen master or if the secondary network is small.

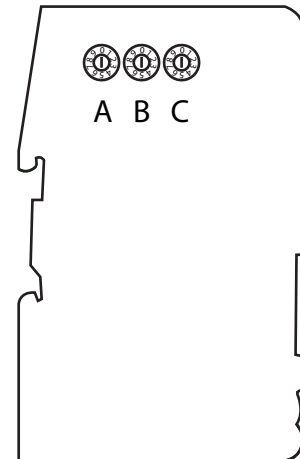

Node Address

The node address is configured using two rotary switches as follows:

$$\text{Node Address} = (\text{Switch B} \times 10) + (\text{Switch C} \times 1)$$

Example: To set node address 42, set switch B to '4' and switch C to '2'.

2.5 USB Connector

At the bottom of the module, next to the CANopen connector for the secondary network, you find a USB connector that is only used for software upgrade of the module.

Pin no.	Description
1	+5 V input
2	USBDM (USB communication signals)
3	USBDP (USB communication signals)
4	Signal GND
Housing	Cable Shield

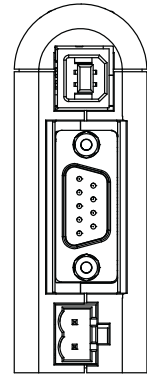
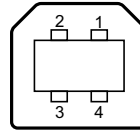

This port can only be used for software upgrade.

2.5.1 Power Connector

Pin no.	Description
1	+24V DC
2	GND



Notes:

- Use 60/75 or 75° C copper (CU) wire only.
 - The terminal tightening torque must be between 5... 7 lbs-in (0.5... 0.8 Nm)
- See also...
- “Power Supply” on page 45

2.6 Hardware Installation

Perform the following steps when physically installing the gateway:

1. Set the Node Address and the baud rate for the secondary CANopen network (see “Configuration Switches” on page 10).
2. Set the configuration switches for the Modbus RTU network.
3. Snap the gateway on to the DIN-rail (See “External View” on page 6)

The DIN-rail mechanism works as follows:

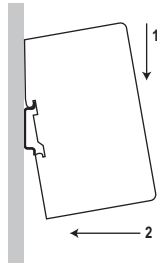

To snap the gateway *on*, first press the it downwards (1) to compress the spring in the DIN-rail mechanism, then push it against the DIN-rail as to make it snap on (2)

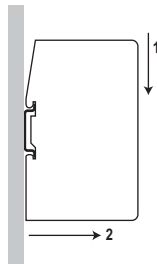

To snap the gateway *off*, push the it downwards (1) and pull it out from the DIN-rail (2), as to make it snap off from the DIN-rail.

4. Connect the gateway to the secondary CANopen network.
5. Connect the gateway to the Modbus RTU network.
6. Connect the power cable and apply power

2.7 CANopen Electronic Data Sheet (EDS)

Each device on CANopen is associated with a CANopen Electronic Data Sheet (a.k.a EDS file), which holds a description of the device and its functions. Most importantly, the file describes the object dictionary implementation in the device. This file should be uploaded to the CANopen configuration tool when configuring the secondary CANopen network.

The latest version of the EDS file for the Anybus X-gateway CANopen can be downloaded from the HMS web site, 'www.anybus.com'.

3. Getting Started

The purpose of this chapter is to give a short description on how to install the module and get it up and running, transferring I/O data between the primary Modbus RTU network and the secondary CANopen sub-network.

Note: The CANopen (secondary) sub-network interface is configured prior to the primary Modbus RTU network interface. The Anybus X-gateway CANopen - Modbus RTU module has to be restarted after this configuration has been finished.

Perform the following steps when installing the gateway:

1. Set the CANopen node ID and operating baud rate for the X-gateway on the secondary CANopen network (see “Configuration Switches” on page 10).
2. Set the Modbus RTU baud rate, node address and parity and choose physical interface, see “Configuration Switches” on page 8.
3. Snap the gateway on to the DIN-rail (See “Hardware Installation” on page 12).
4. Connect the gateway to the CANopen (secondary) sub-network, using the connector at the bottom of the module.
5. Connect the power cable and apply power.
6. Download the appropriate EDS file from HMS to the external CANopen configuration tool. See “CANopen Electronic Data Sheet (EDS)” on page 13.
7. Decide how much data will be transferred. This amount is always configured for the module’s interface to the secondary network. A description of how the data is mapped to the Anybus X-gateway CANopen is found in “I/O Buffer Addresses and Object Dictionary Indices Relation” on page 43.
8. Consult the “Enabling Data Exchange” on page 49 to configure the module and the secondary CANopen network.
9. Connect the gateway to the primary Modbus RTU network.
10. Restart the gateway.
11. The actual configuration of the module is performed while configuring the Modbus RTU master and the Modbus RTU network, see “Configuration of the Modbus RTU Interface” on page 19. The I/O buffers of the module contains 512 bytes, but the amount of I/O data is decided by the CANopen configuration.

4. CANopen Fieldbus Functionality

The functionality of the Anybus X-gateway CANopen master/slave on the secondary network is defined by the CANopen DS301 Rev. 4.2 specification and DSP302 (part 1-5).

Note: The first time the module starts up, it starts as a slave on the secondary CANopen network. It can be set as master during configuration, see “Enabling Data Exchange” on page 53. This setting can be saved in the module so that it will start as a master the next time.

4.1 Supported Fieldbus Services

Communication and parameters in the CANopen protocol are built around objects. There are different services available to communicate with the objects and to perform other CANopen tasks like supervising the network. The following message types and objects are implemented in the Anybus X-gateway CANopen:

- NMT (Network Management)¹ messages configure and initialize the network, as well as monitor the network and handle errors. If the module is configured as a slave, startup is performed by a master on the network.
- CMT (Configuration Manager)¹ messages are used for configuration of CANopen devices. This primarily involves PDO parameters and mapping of information. If the module is configured as a slave, the configuration is performed by a master on the network.
- PDOs (Process Data Objects) are used for I/O communication. There are 128 Receive PDOs and 128 Transmit PDOs implemented in the Anybus X-gateway CANopen that each can transfer up to 8 bytes. Supported PDO message types are COS (Change of state), Cyclic Synchronous and Acyclic Synchronous.²
- SDOs (Service Data Objects) use asynchronous data transmission and are used to access objects without mapping them to an I/O (PDO) connection. Access is provided to all CANopen objects in the module and in the network nodes (master mode). The SDO messages are used to configure the module and they can transfer more than 8 bytes, which is the upper limit for a PDO. (Expedited Upload/Download Protocol and Segmented Upload/Download Protocol are supported)
- A SYNC (Synchronization Object) is used for synchronizing PDO communication. A master can be either a producer or a consumer of the synchronization. A slave can only be a consumer.
- The Heartbeat Mechanism helps a device to monitor the status of another node. The module can appear both as heartbeat producer and consumer.
- The Node Guarding Protocol provides active surveillance of a slave by the master. Slaves can be configured to expect a node guarding request from the master.
- An EMCY (Emergency Object) is used for error reporting when a fatal fault has occurred in the module itself or in other monitored/supervised modules.
- LSS (Layer Setting Services)¹. An LSS master can configure baud rate and node ID of all slaves that support LSS (i.e. the preconfigured baud rate and node ID of a slave can be changed by a master).

1. Only available when the module is configured as master.

2. The data exchange with the Modbus RTU network is limited to 512 bytes, affecting the total number of PDOs that can be used in an application.

5. Configuration

This chapter describes the configuration of the secondary CANopen network interface as well as the configuration of the primary Modbus RTU network adapter/slave interface of the module. The secondary CANopen network interface is configured prior to the primary Modbus RTU network adapter/slave interface. The I/O data sizes configured for the secondary CANopen network decides the data sizes on the primary Modbus RTU network adapter/slave interface.

5.1 CANopen Master/Slave Configuration

The nodes on the secondary CANopen network, including the interface of the Anybus X-gateway on this network, have to be configured using an external CANopen configuration tool running on a computer. The configuration is downloaded to the secondary CANopen network master using a CANopen adapter.¹

The module is by default configured as a slave at startup. To enable it to perform as a CANopen master, please set this during configuration, see “Enabling Data Exchange” on page 49 and “NMT Start-up, 1F80h” on page 36.

The following parameters have to be defined:

Parameter	Description	Values	Comment
Node Number	Node ID on the secondary CANopen Network. Allowed values are 1 - 127.	1-127	Node ID (1-99) is set using rotary switches, see “Configuration Switches” on page 10. Node IDs above 99 can be set using the configuration tool or from the CANopen network.
Baud rate	This parameter defines the baud rate on the secondary CANopen network. If “Auto” is selected the baud rate will be automatically detected.	20 kbit/s 50 kbit/s 125 kbit/s 250 kbit/s 500 kbit/s 800 kbit/s 1000 kbit/s Auto	Set using rotary switches, see “Configuration Switches” on page 10 Automatic baud rate should only be used if the module is used as a slave on the secondary network.
Set master	Set the module to be CANopen master. At startup the module is a slave by default. This can be changed during configuration.		See “NMT Start-up, 1F80h” on page 36.
CANopen input data size	This parameter defines the size of the readable data array on the primary network interface. Data to the primary network from the secondary CANopen network.	2 - 512 ^a	The first 2 bytes in the array are used for the status word, so the maximum data size from the secondary CANopen network is 2 bytes less than the maximum value allowed for this parameter. See object 3000h on page 44.
CANopen output data size	This parameter defines the size of the writable data array on the primary network interface. Data from the primary network interface to the secondary CANopen network.	2 - 512 ^a	The first 2 bytes in the array are used for the control word, so the maximum data size to the secondary CANopen network is 2 bytes less than the maximum value allowed for this parameter. See object 3001h on page 44.

a. The data buffers in the Anybus X-gateway CANopen module can hold 512 bytes of data, but the actual maximum data size is highly dependent on network. Please consult the section on configuration of the controlling network further on in this chapter.

Note: The input and output data sizes are configured for the secondary CANopen network interface. The master of the primary network will have to take these values into consideration, as they will be used by the primary Modbus RTU network adapter/slave interface of the module.

1. Please contact HMS support for further information, see “Sales and Support” on page 1.

5.2 Secondary CANopen Network Configuration

An external CANopen configuration tool is used to configure the nodes on the secondary CANopen network. Each node can be configured locally or a Concise DCF file can be downloaded to the CANopen network master using a CANopen adapter¹. At the next startup the CANopen master will configure the network, if this function was set in the configuration tool during initial configuration.

The first time the Anybus X-gateway CANopen is started it starts up as a slave. It can be configured as a master, and if it is, it will continue to start up as a master.

1. Download the EDS file² for the Anybus X-gateway CANopen from www.anybus.com to your PC.
2. Prepare EDS files for all other nodes present on the secondary network.
3. Open the CANopen configuration tool.
4. Upload the EDS files to the configuration tool.
5. Add nodes to the CANopen network.
6. Configure each node with the necessary parameters.
7. Set Input Data Size in object 3000h and Output Data Size in object 3001h, to define the I/O data size between the secondary CANopen network (sub-network) and the primary Modbus RTU network (slave interface). Default values are 16 bytes (14 bytes of data exchanged between the networks + 2 bytes Control/Status Word). See “General Fieldbus Parameters” on page 44.
8. Download the configuration to the CANopen network as Concise DCF to the master or store the configuration locally in each module’s nonvolatile memory.

Please consult the user manual for the configuration tool for details and/or contact HMS support, see “Sales and Support” on page 1. For an example, see “Enabling Data Exchange” on page 49.

To configure the primary Modbus RTU adapter/slave interface, restart the module, and then configure the Modbus RTU network using appropriate configuration tools, see below. Please remember that the amount of data that can be exchanged already is decided by the previous configuration of the secondary CANopen network (CANopen objects 3000h and 3001h). The first two bytes of the input data and the output data are always used for status and control information.

5.2.1 LSS Routine

If there is a missing slave on the network after the boot timeout (defined in object 1F89h, page 40) the master will initiate the LSS routine. It will send an identify slave request. If one (and only one) slave responds to that message, the master sets the NodeID of that node to the first available NodeID. The master will then send a bootup request to the slave.

1. Please visit www.anybus.com or contact HMS support for further information, see “Sales and Support” on page 1.
2. The EDS file for the Anybus X-gateway CANopen can be downloaded from www.anybus.com.

5.3 Configuration of the Modbus RTU Interface

5.3.1 Data Exchange

The first two bytes of the I/O area are used for the status/control word. Thus the interface exchanges up to 510 bytes of I/O data in each direction.

The control and status words are used by the Modbus RTU master to control the CANopen network and to read the status of the CANopen network. The contents of the control and status words are described in “Data Exchange” on page 24.

The amount of data that is exchanged as I/O Data is specified when configuring the CANopen master interface. The data arriving from the CANopen master is completely transparent. The interpreting has to be defined by the master on the Modbus RTU network.

The Slave Interface acts as a passive node and as such it responds to incoming Queries and accepts broadcast messages. It will not initiate communication autonomously.

In the Anybus implementation, several Modbus functions are associated with the very same data. While this may appear confusing at first, it allows data to be manipulated in a very flexible manner (e.g. it is possible to manipulate individual bits of a register by accessing coils associated with the same memory location).

The following functions can be used to access data in the Slave Interface:

Modbus Function	Function Code	Direction	Associated with Buffer
Read Coil	1	Gateway to Modbus	Input- and Output Buffers
Read Input Discretes	2		
Read Holding Registers	3		
Read Input Registers	4		
Write Coil	5	Modbus to Gateway	Output Buffer
Write Single Register	6		
Force Multiple Coils	15		
Force Multiple Registers	16		
Mask Write Register	22		
Read/Write Registers	23	Bidirectional	Input- and Output Buffers

See also...

- “Coil & Register Map” on page 20

5.3.2 Modbus Exceptions

With the exception of broadcast messages, the Modbus Master expects its slaves to respond within a certain defined time period. If no response is received (e.g. due to a transmission error), this eventually triggers a timeout condition in the Master.

If the Slave Interface receives a Query from the Master, but for some reason is unable to process it (e.g. the Master tries to access a non-existent Register), an Exception is returned to inform the Master of the nature of the problem.

The Slave Interface may issue the following Exception responses:

#	Meaning	Description
01h	Illegal Function	The Query contains an illegal or unsupported function call

02h	Illegal Data Address	The Query contains an illegal data address
03h	Illegal Data Value	The Query contains invalid data

5.3.3 Coil & Register Map

The Input & Output Buffers are mapped to coils and registers as follows:

Register #	Coil #	Buffer	Location in Buffer	Comments
1	1... 16	Input Buffer	000... 001h	Applicable Modbus functions: - Read Coil - Read Input Discretes - Read Holding Registers - Read Input Registers - Read/Write Registers
2	17... 32		002... 003h	
3	33... 48		004... 005h	
4	49... 64		006... 007h	
5	65... 80		008... 009h	
6	81... 96		00A... 00Bh	
7	97... 112		00C... 00Dh	
...	
255	4065... 4080		1FC... 1FDh	
256	4081... 4096		1FE... 1FFh	
257... 1024	4097... 16384	-	-	(reserved)
1025	16385... 16400	Output Buffer	000... 001h	Applicable Modbus functions: - Read Coil - Read Input Discretes - Read Holding Registers - Read Input Registers - Write Coil - Write Single Register - Force Multiple Coils - Force Multiple Registers - Mask Write Register - Read/Write Registers
1026	16401... 16416		002... 003h	
1027	16417... 16432		004... 005h	
1028	16433... 16448		006... 007h	
1029	16449... 16464		008... 009h	
1030	16465... 16480		00A... 00Bh	
1031	16481... 16496		00C... 00Dh	
...	
1279	20449... 20464		1FC... 1FDh	
1280	20465... 20480		1FE... 1FFh	
1281...	20481...	-	-	(reserved)

Note 1: Coils are mapped MSB first, i.e. coil 1 corresponds to bit 15 of register 1.

Note 2: Modbus RTU uses big endian, e.g. the first byte in the Input Buffer corresponds to the most significant byte of register 1.

Note 3: The status word is mapped to the first two bytes of the Input Buffer (Modbus register 30001 or 300001 depending on PLC). Thus the first transferred data from the CANopen data area/map is read from register 30002 (or 300002).

Note 4: The control word is mapped to the first two bytes of the Output Buffer (Modbus register 41025 or 401025 depending on PLC). Thus the first transferred data to the CANopen data area/map is written into register 41026 (or 401026).

5.3.4 Modbus Diagnostics

The Modbus RTU interface features several diagnostic counters which increment each time the interface encounters certain predefined events. These counters may provide valuable clues when troubleshooting the Modbus communication, and can be accessed through the standard Modbus Diagnostic function (function code 08h).

The following subfunctions are implemented:

#	Meaning	Description
00h	Return Query Data	Loopback; instructs the slave to return the data from the Query
0Ah	Clear Counters and Diagnostic Register	Clears all diagnostic counters
0Ch	Return Bus Communication Error Count	Returns the no. of detected CRC-errors
0Dh	Return Bus Exception Error Count	Returns the no. of exception responses previously returned by the slave
0Eh	Return Slave Message Count	Returns the number of messages addressed to the slave interface (broadcast included)

5.3.5 Network Termination

The end nodes of an RS485-based Modbus RTU network must be terminated in order to avoid reflections on the bus line.

The figure below shows the connection and the values of the internal termination and bias resistors. If the values does not match the network termination convention, external termination must be used.

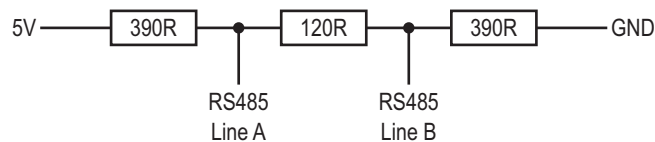

5.3.6 Configuration

After the configuration of the CANopen master interface has been finalized, the module has to be re-started before the configuration of the Modbus RTU slave interface can be started.

The slave interface is part of a Modbus RTU network, and will have to be configured within this. The configuration tool used when configuring the Modbus RTU master and the Modbus RTU network will thus have to be used to configure the slave interface as well. Please note that the size of the I/O data that can be read from and written to the module is defined when configuring the CANopen master interface. Also note the Modbus RTU specific settings, described on 44.

There are a number of different configuration tools for Modbus RTU available on the market. The choice of tool depends on the application and the Modbus RTU scanner of the network.

An application note, describing how to configure an Anybus Modbus RTU slave interface with Unity Pro L, is available on the support pages for the Anybus X-gateway CANopen to Modbus RTU module at 'www.anybus.com'.

5.4 Enabling Data Exchange

Once both the interfaces of the X-gateway have been properly configured, the PLC (the master) on the primary network will have to explicitly allow the X-gateway to exchange I/O data, for any I/O data exchange to occur between the primary and the secondary networks. To accomplish this, the PLC will write the command “OPERATIONAL#” in the control word, see “Control Word” on page 25 for further information.

If the module is set as master, it will automatically be available when the PLC has enabled data exchange. The module will control the secondary network, using the instructions sent in the control word from the PLC.

If the module is set as slave, it will wait for a request from the master of the secondary network before starting to exchange data. If it has not been enabled by the PLC to exchange data, it will return an error message to the secondary network.

6. CANopen Module Specification

6.1 NMT State Machine

The function of the Anybus X-gateway CANopen can be described as a state machine with four states.

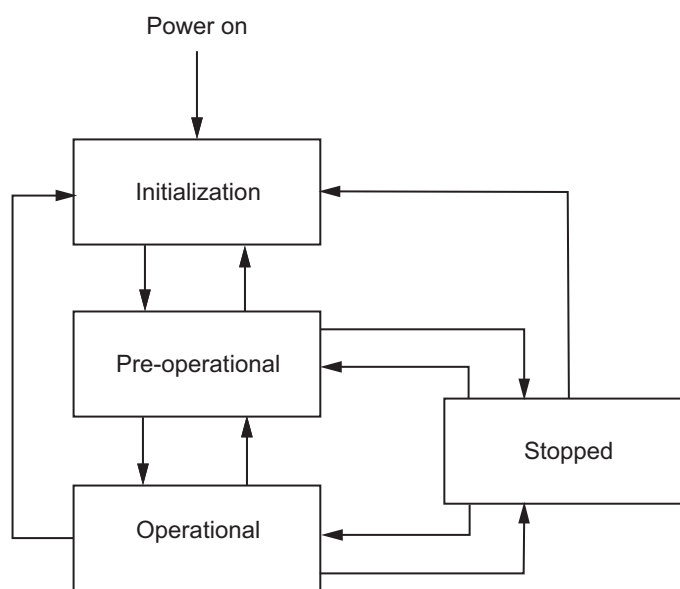

State	Description
Initialization	When the power is switched on, the module starts initializing. The parameters are set to the so called power-on values, which are the default values or the latest stored values. If parameter values are stored from a previous configuration, these are used. If not, or if a <code>restore_default</code> command is issued, the parameters are reset to the default values according to the communication and device profile specifications.
Pre-operational	Once initialized, the module automatically enters the pre-operational state. The Anybus X-gateway CANopen can be configured, but no I/O data can be exchanged.
Operational	In the operational state all communication objects are active. I/O data is communicated according to the configuration made.
Stopped	All communication is stopped, except node guarding and heartbeat, if active. From this state any transition to another state is possible, depending on if a restart, reconfiguration or reset of the module is wanted.

The module changes states upon reception of a request from an NMT object, a hardware reset or Module Control Services locally initiated by application events.

6.2 Data Exchange

The Anybus X-gateway CANopen allows for the exchange of 512 bytes of data in each direction between the primary network and the X-gateway. The first two bytes (the first word) are allocated for a Control/Status word, decreasing the size of I/O data for CANopen to 510 bytes. The actual amount of data that can be exchanged is highly network dependent, see the section on configuration of the primary Modbus RTU network in chapter 5.

The control and status words of the module are used by the master of the primary Modbus RTU network to control the Anybus X-gateway CANopen and the secondary CANopen network, and to report the status back from this network. The rest of the I/O data area is available in the CANopen vendor specific object area for real-time data transfer using PDOs (Process Data Objects).

Note: The functionality of the Control/Status word differs depending on if the Anybus X-gateway CANopen interface is configured as a slave or as a master on the secondary network.

6.2.1 Control Word

The control word is used to control the CANopen network of the Anybus X-gateway CANopen. It is triggered on a CoS (Change of State) event.

Control Word				Effective I/O Data
Byte 0			Byte 1	Byte 2 - 510
Toggle bit ^a	Cmd, 3 bits	CmdExt, 4 bits	NodeID ^b	Data

- The most significant bit in byte 0 is a toggle bit, that is toggled by the controlling network each time a new command is issued.
- If NodeID = 0, the command is valid only for the node that the module constitutes. If NodeID = 128 (80h), the command is valid for the complete secondary CANopen network. Any other NodeID value will specify the single node that the command is valid for. If the Anybus X-gateway CANopen interface is configured as a slave on the secondary network the only allowed value of NodeID is 0.

Supported commands

The table below shows available commands and their representation in byte 0 of the control word.

Toggle bit ^a	Cmd (3 bits)	CmdExt (4 bits)	Name	Master functionality	Slave functionality
-	0h	-	(Set NMT State)	This command sets the NMT state of a CANopen node or the CANopen network, according to the value of NodeID.	The NMT state is set by the controlling PLC. If the PLC is running, the NMT state is set to OPERATIONAL. If the PLC is not running, the NMT state is set to PRE-OPERATIONAL. ^b
		0h	PRE-OPERATIONAL		
		1h	OPERATIONAL		
		2h	RESET NODE		
		3h	RESET COMMUNICATION		
		4h	STOP		
	5h - Fh	-	(reserved)	Default: PRE-OPERATIONAL	
1h			Get Node state	This command requests the state set in object 1F82h, see 38, of the CANopen node or network (depending on the value of NodeID). ^{c d}	
2h			Get COPM general status	This command requests the general status of the CANopen module	
	3h - 6h		(reserved)		
	7h	-	(No operation)	No Operation It is recommended to set Cmd to this value, when the module goes offline from the fieldbus. This prevents unwanted behavior of the CANopen network, when the fieldbus comes back online.	

- The most significant bit in byte 0 is a toggle bit, that is toggled by the controlling network each time a new command is issued.
- IMPORTANT:** The PLC controlling the primary network has to set the X-gateway to OPERATIONAL using the Control Word. If this has not been done, the X-gateway will decline an NMT Set Operational Command on the secondary network by returning an emergency message with the error code FF10h. The same emergency message will be sent when the X-gateway is reset to PRE-OPERATIONAL by the primary network.
- If the module is configured as slave, only NodeID = 0 is allowed.
- Only states of nodes monitored by node guarding or heartbeat can be read from object 1F82h.

When started, the module will initialize, and then automatically continue to the state PRE-OPERATIONAL.

I/O data will only be exchanged if the module is in the state OPERATIONAL. To make this possible, the PLC controlling the primary network will have to give the command “Set NMT State (OPERA-

TIONAL)” in the control word. If the module is set as master, it will then administer the secondary network. If the module is set as slave, it will answer to any request from the master of the secondary network to participate in the communication on that network (see footnote in the table above).

The command RESET NODE will restore the module to a previously downloaded configuration. RESET COMMUNICATION will restore the communication settings of the module. In both cases the module will return to the INITIALIZATION state.

Examples

Master/Slave	Control Word ^a	Meaning
Slave	01 00h	01h: Allow the module to go to OPERATIONAL if asked by an NMT master. 00h: The command is only valid for the module itself.
Master	01 80h	01h Start remote node in the secondary network. 80h The command is valid for all nodes in the secondary network.
	01 02h	01h Start remote node. 02h The command is valid for node 2.
	04 80h	04h Stop remote node. 80h The command is valid for all nodes in the secondary network.

a. The first bit in the control word is toggled for each new command, e.g. changing the first byte from 01h to 81h

6.2.2 Status Word

Byte 0 in the status word shows the last valid command and command extension written to the control word, to indicate that the command has been performed. Byte 1 gives the lowest NodeID with error. Please note that there can be one or more nodes, with higher NodeIDs, that also have errors. If NodeID is 0, all nodes are fine. If NodeID is for example 5, it means that there is an error with node 5.

Only errors from nodes monitored by the heartbeat mechanism or by node guarding will be reported. Errors from other slaves can not be recognized.

Status Word			Effective I/O Data	
Byte 0		Byte 1	Byte 2 - 510	
Toggle bit ^a	Cmd Rsp, 3 bits	CmdExt, 4 bits	Error Node	Data

a. The most significant bit in byte 0 is a toggle bit, that is toggled by the module to mirror the toggle bit of the control word.

Supported commands

The table below shows available command responses and their representation in byte 0 of the status word.

Toggle bit ^a	CmdRsp (3 bits)	CmdExtRsp (4 bits)	Name	Master	Slave
-	0h	-	(Set NMT State)	Response to Set NMT State command. Reflects the command.	Response to Set NMT State command. Reflects the command.
		0h	PRE-OPERATIONAL		
		1h	OPERATIONAL		
		2h	RESET NODE		
		3h	RESET COMMUNICATION		
		4h	STOP		
		5h - Fh	-		
	1h	-	(Get Node state)	This response reflects the state set in object 1F82h, see 38, of a CANopen node or network (depending on the value of NodeId).	This response reflects the state set in object 1F82h, see 38, of the module's CANopen interface.
		0h	PRE-OPERATIONAL		
		1h	OPERATIONAL		
		2h	RESET NODE		
		3h	RESET COMMUNICATION		
		4h	STOP		
5h		UNKNOWN			
6h		MISSING			
7h - Eh		-			
Fh	ERROR				
2h	Bit:	(Get COPM general status)	This response requests the CANopen status of the module		
	0	CAN_BUS_OFF	Bus off		
	1	CAN_ERR_PASV	Error passive		
	2	ERR_NG_HB	Node guarding or Heartbeat error		
	3	ERR_SYNC	Sync error		
3h - 6h	(reserved)				
7h	-	(No operation)	Reflects the command		

a. The most significant bit in byte 0 is a toggle bit, that is toggled by the module to mirror the toggle bit of the control word.

6.2.3 Example

The example shows two control words from the primary network master to the module. Each control word includes a command that affects the secondary CANopen network. Each control word is acknowledged by a status word, that contains a response to the command. Note that the first bit in the control word is toggled when a new command is sent, to make sure it is distinguished from the previous command.

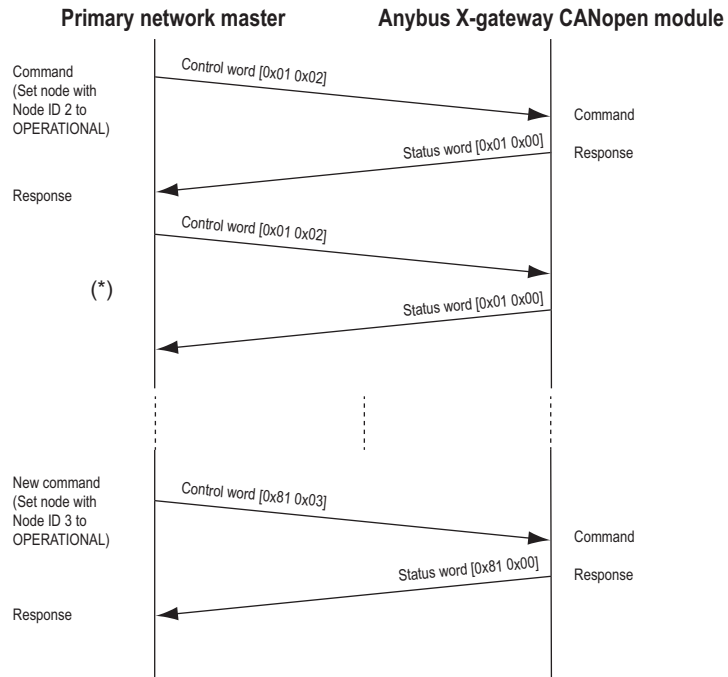

(*) The communication is performed in an ongoing ping-pong fashion. The same command is sent repeatedly, but as long as the toggle bit is not changed, the module will ignore the message. A new command is signalled by the toggle bit changing value.

6.2.4 PDO Functionality

Real-time data transfer is performed by means of PDOs (Process Data Objects). The PDOs are linked to entries in the Device Object Dictionary and provide the interface to the application objects. The number and length of PDOs in a device are node specific and have to be configured by the CANopen configuration tool.

PDOs are used both for data transmission and reception, using so called Transmit-PDOs (TPDOs) and Receive-PDOs (RPDOs). Each PDO corresponds to two entries in the Device Object Dictionary. The PDO parameter object holds information on the COB-ID, the transmission type etc. On recognition of the COB-ID the corresponding PDO mapping object can be identified, to make it possible to transmit/receive data to/from the correct object in the device. The default settings for the mapping can be changed during configuration.

Default PDO Mapping Scheme

The module features a simple default mapping scheme with 4 TPDOs and 4 RPDOs.

- **RPDO**

RPDO no.	Default COB IDs	Mapped to...	Relating to...	Default State
1	200h + Node ID	Object index 2100h, subindex 1... 8	Receive bytes 2... 9	Enabled
2	300h + Node ID	Object index 2100h, subindex 9... 16	Receive bytes 10... 17	
3	400h + Node ID	Object index 2100h, subindex 17... 24	Receive bytes 18... 25	
4	500h + Node ID	Object index 2100h, subindex 25... 32	Receive bytes 26... 33	
5	80000000h	Object index 2100h, subindex 33... 40	Receive bytes 34... 41	Disabled
...		
128		Object index 2103h, subindex 121 ... 126	Receive bytes 506... 511	

- **TPDO**

TPDO no.	Default COB IDs	Mapped to...	Relating to...	Default State
1	180h + Node ID	Object index 2000h, subindex 1... 8	Transmit bytes 2... 9	Enabled
2	280h + Node ID	Object index 2000h, subindex 9... 16	Transmit bytes 10... 17	
3	380h + Node ID	Object index 2000h, subindex 17... 24	Transmit bytes 18... 25	
4	480h + Node ID	Object index 2000h, subindex 25... 32	Transmit bytes 26... 33	
5	80000000h	Object index 2000h, subindex 33... 40	Transmit bytes 34... 41	Disabled
...		
128		Object index 2003h, subindex 121 ... 126	Transmit bytes 506... 511	

For more information on the mapping see “Vendor Specific Objects” on page 40

RPDO Transmission Types

The RPDOs can be received either in synchronous or asynchronous mode. A synchronization (SYNC) object is transmitted periodically by a synchronization master. The data in synchronous RPDOs are not transferred to the application until after the next SYNC object is received. Asynchronous RPDOs will be transferred directly.

The transmission type parameter of a RPDO specifies the triggering mode.

Transmission type, RPDO	Mode	RPDO transmission description
0 - 240	Synchronous	A received RPDO is transferred to the application after a SYNC object is received.
241 - 253	-	Reserved
254 - 255 (Default = 255)	Event driven	An RPDO is transmitted without any relation to the SYNC object.

TPDO Transmission Types

The TPDOs can be transmitted either in synchronous or asynchronous mode. A synchronization (SYNC) object is transmitted periodically by a synchronization master. Synchronous TPDOs are transmitted within a predefined time-window immediately after a configured number of SYNC objects, or after the SYNC object that follows upon a CoS (Change of State event). Asynchronous TPDOs can be transmitted at any time, triggered by a CoS or a cyclic period set in the Event Timer.

The transmission type parameter of a TPDO specifies the transmission mode as well as the triggering mode.

Transmission type, TPDO	Mode	TPDO transmission description
0	Synchronous, acyclic	A TPDO is triggered by an event, but not transmitted before the occurrence of a SYNC object.
1 - 240	Synchronous, cyclic	A TPDO is transmitted with every n-th SYNC object, where n is a defined number from 1 - 240.
241 - 253	-	Reserved
254 - 255 (Default = 255)	Event driven	A TPDO is transmitted without any relation to the SYNC object. The transmission is triggered by a CoS event or if a specified time has elapsed without an event.

6.3 LSS Services

LSS master functionality according to the CANopen DS305 specification is supported by the module. The module can configure baud rate and node ID of all slaves that support LSS (i.e. the preconfigured baud rate and node ID of a slave can be changed by a master). The module can not act as an LSS slave.

An LSS Slave is identified by its LSS address, that consists of Vendor ID, Product Code, Revision Number and Serial Number of the LSS slave module. If there is a missing slave on the network after the boot timeout, the master will initiate the LSS routine, see Network Management Object "Boot Time, 1F89h" on page 40. It will send an identify slave request, using the LSS address of the slave. If one (and only one) slave responds to this request, the master will set the NodeID on that node to the first missing NodeID. It will then send a bootstrap message to the node.

6.4 Error Control

It is strongly recommended to monitor the network. The Anybus X-gateway CANopen can use either Heartbeat or Node Guarding. At an error event from any of these, the active I/O data is frozen, as no new data will be available.

6.4.1 Heartbeat Mechanism

The Heartbeat Mechanism is used to monitor the nodes in the network and verifies that the nodes are available. A heartbeat producer periodically sends a message. The data part of the frame contains a byte indicating the node status. The heartbeat consumer reads these messages. If a message fails to arrive within a certain time limit (defined in the object directory of the devices, objects 1016h and 1017h, 33), a heartbeat event is registered by the consumer. The ERROR LED on the front of the Anybus X-gateway CANopen and the status word will indicate the event. An EMCY object (8130h) is also transmitted on the CANopen fieldbus. If the module is configured as a slave and is in OPERATIONAL state, it will go to PRE-OPERATIONAL state and wait for the user to take action. If it is in master mode, it will take action according to the settings in the master objects.

The Anybus X-gateway CANopen can act both as heartbeat consumer and as heartbeat producer simultaneously.

6.4.2 Node Guarding

The NMT Master transmits guarding requests. If an NMT Slave has not responded within a defined time span (node lifetime) or if the communication status of the slave has changed, the master takes appropriate action according to its configuration.

If Life guarding (the slave guards the master) is supported, the slave uses the guard time and lifetime factor from its Object Dictionary to determine the node lifetime. If the slave does not receive a guarding request within its lifetime, a node guard event is registered. The ERROR LED on the front of the Anybus X-gateway CANopen will indicate the event. An EMCY object (8130h) is also transmitted on the CANopen fieldbus.

If the guard time or the lifetime factor are 0 (default), the Slave does not guard the Master. The guarding can be initiated at boot-up or later.

Note: The NMT master can monitor a slave either by heartbeat or by node guarding. Only one of these mechanisms at a time can be active. Heartbeat is preferred and if heartbeat is enabled in a slave, any node guarding for that slave is disabled.

6.4.3 Emergency Object (EMCY)

The Emergency Object is used for error reporting on the CANopen network when a fatal fault has occurred. The error codes are saved in a list in the Communication Profile Object 1003h, see page 32, and a message is produced on the CANopen network. A list of emergency error codes, that can be produced by the module, is available in “CANopen Emergency Codes” on page 48.

7. CANopen Supported Objects

The following sections describe the CANopen objects (secondary CANopen network), according to DS301 and DS302, implemented within the module and described in the EDS file.

7.1 Static Data Types

The Static Data Types are implemented according to the DS321 specification from CiA (CAN in Automation).

7.2 Communication Profile Area

7.2.1 DS301 Communication Profile Objects

The table below shows the objects according to CANopen specification DS301 rev. 4.2.

Index	Object Name	Subindex	Description	Type	Access	Notes
1000h	Device Type	00h	Type of device	U32	RO	0000 0000h (No profile)
1001h	Error register	00h	Error register, connected to the EMCY object. Bit 0 indicates a generic error	U8	RO	-
1003h	Predefined error field	00h	Number of errors. Writing a 0 to this subindex clears the error list.	U8	RW	See "CANopen Emergency Codes" on page 48 for emergency error codes.
		01h...10h	List of errors. Most recent error at top of list.	U32	RO	
1005h	COB-ID Sync	00h	ID of the sync message	U32	RW	-
1006h	Communication Cycle Period	00h	Communication cycle period	U32	RW	Only available if SYNC support is enabled
1007h	Synchronous Window Length	00h	Synchronous Window Length	U32	RW	Only available if SYNC support is enabled
1008h	Manufacturer device name	00h	The name of the CANopen module	Visible string	RO	"Anybus X-gateway CANopen"
1009h	Manufacturer hardware version	00h	Manufacturer hardware version	Visible string	RO	Current hardware revision
100Ah	Manufacturer software version	00h	Manufacturer software version	Visible string	RO	Set by HMS
100Ch	Guard time	00h	Used together with "Life time factor" to decide the node lifetime in ms	U16	RW	0000h (default)
100Dh	Life time factor	00h	If the node has not been guarded within its lifetime ("Life time factor" * "Guard time"), an error event is logged and a remote node error is indicated	U8	RW	00h (default)

Index	Object Name	Subindex	Description	Type	Access	Notes
1010h	Store Parameters	00h	Largest subindex supported	U8	RO	01h
		01h	Store all parameters	U32	RW	To save a configuration, write "save" = 73 61 76 65h to this object. ^a See also "General Fieldbus Parameters" on page 44.
1011h	Restore Parameters	00h	Largest sub index supported	U8	RO	01h
		01h	Restore all parameters	U32	RW	To restore the default values of a configuration, write "load" = 6C 6F 61 64h to this object. ^a
1014h	COB-ID EMCY	00h	Defines the COB-ID of the Emergency Object	U32	RO	
1016h	Consumer Heartbeat Time	00h	Largest subindex supported	U8	RO	7Fh
		01h - 80h	The consumer heartbeat time defines the expected heartbeat cycle time and has to be higher than the corresponding producer heartbeat time. Monitoring starts after the reception of the first heartbeat. Not used if 0	U32	RW	Node ID + Heartbeat Time. Bits 31-24: reserved Bits 23-16: Node ID Bits 15-0: Heartbeat Time Value must be a multiple of 1 ms. Up to 127 nodes can be monitored.
1017h	Producer Heartbeat Time	00h	Defines the cycle time of the heartbeat. Not used if 0	U16	RW	The time must be at least 10 ms and a multiple of 1 ms
1018h	Identity object	00h	Number of entries	U8	RO	04h
		01h	Vendor ID	U32	RO	1Bh (HMS Industrial Networks)
		02h	Product Code	U32	RO	18h (Anybus X-gateway CANopen)
		03h	Revision Number	U32	RO	Current software revision
		04h	Serial Number	U32	RO	HMS serial number
1029h	Error behavior object	00h	Number of entries	U8	RO	
		01h	Communication error	U8	RO	00h: Change to Preoperational if currently in NMT state Operational
		02h	Profile or manufacturer specific error	U8	RO	00h: Change to Preoperational if currently in NMT state Operational
1400h ... 147Fh	Receive PDO parameter	00h	Largest subindex supported	U8	RO	02h
		01h	COB-ID used by PDO	U32	RW	-
		02h	Transmission type	U8	RW	See "RPDO Transmission Types" on page 30
1600h ... 167Fh	Receive PDO mapping	00h	No. of mapped application objects in PDO	U8	RW	-
		01h	Mapped object #1	U32	RW	-
		02h	Mapped object #2	U32	RW	-
		03h	Mapped object #3	U32	RW	-
		04h	Mapped object #4	U32	RW	-
		05h	Mapped object #5	U32	RW	-
		06h	Mapped object #6	U32	RW	-
		07h	Mapped object #7	U32	RW	-
		08h	Mapped object #8	U32	RW	-

Index	Object Name	Subindex	Description	Type	Access	Notes
1800h ... 187Fh	Transmit PDO parameter	00h	Largest subindex supported	U8	RO	05h
		01h	COB-ID used by PDO	U32	RW	-
		02h	Transmission type	U8	RW	See "TPDO Transmission Types" on page 30
		03h	Inhibit time	U16	RW	In steps of 0.1 ms
		05h	Event Timer (ms)	U16	RW	-
1A00h ... 1A7Fh	Transmit PDO mapping	00h	No. of mapped application objects in PDO	U8	RW	-
		01h	Mapped object #1	U32	RW	-
		02h	Mapped object #2	U32	RW	-
		03h	Mapped object #3	U32	RW	-
		04h	Mapped object #4	U32	RW	-
		05h	Mapped object #5	U32	RW	-
		06h	Mapped object #6	U32	RW	-
		07h	Mapped object #7	U32	RW	-
		08h	Mapped object #8	U32	RW	-

- a. Depending on the method of writing to this object, e.g. using a CANopen dongle, the byte order may have to be changed to adapt to the way data is transported on CANopen.

7.2.2 Configuration Manager

DS302 part 3: Configuration and program download

Network Configuration Objects

Index	Object Name	Subindex	Description	Type	Access
1F22h	Concise DCF	-	The concise/compressed DCF files information is stored in this object.	Domain	RW
1F25h	Configure Slave	0 - 128	Subindex 0 is ignored. Subindex i (i = 1 - 127): Request reconfiguration of slave with Node ID equal to subindex i. Subindex 128: Request to reconfigure all slaves.	U32 ^a	Sub 0: RO Sub 1 - 128: WO

- a. To configure the slave with Node ID i, write "conf" = 63 6F 6E 66h to this object (1F25h, subindex i). If this fails, an emergency code is produced (6161h, see "CANopen Emergency Codes" on page 48).

Check Configuration

The Configuration Manager (CMT) compares signature and configuration with the value from the DCF to decide if a reconfiguration is to be performed or not. The comparison values are stored by the Configuration Manager in these objects:

Index	Object Name	Subindex	Description	Type	Access
1F26h	Expected Configuration Date	0 - 127	The date that the Configuration Manager expects to find when comparing signature and configuration.	UNIT32	RW
1F27h	Expected Configuration Time	0 - 127	The time that the Configuration Manager expects to find when comparing signature and configuration.	UINT32	RW

7.2.3 Network Management Objects

The NMT master controls the states of the connected network participants, the NMT slaves. It monitors the devices and reports to the application, for example if an NMT slave fails. Please refer to the CANopen specification, see “Related Documents” on page 1. In more complex systems several devices are able to perform as master, which means that the configuration must have an entry defining which device will act as master.

Once configured, the objects carry all information needed for the module to act on the network and the application does not need to be accessed to obtain this information. This results in a substantial reduction of the overall implementation and maintenance effort when implementing multiple applications.

Index	Object Name	Subindex	Description	Type	Access
1F80h	NMT Start-up	-	Defining whether the device is the NMT Master	U32	RW
1F81h	Slave Assignment	ARRAY	Module list: Entry of all slaves to be managed, including guarding values and the entry of actions to be taken in event of guarding errors.	U32	Sub 0: RO Sub 1 - 127: RW
1F82h	Request NMT	ARRAY	Remote control initiation of NMT services. For example, tools can use this to request intentional start/stop of individual slaves. Remote query of the current state.	U8	Sub 0: RO Sub 1 - 127: RW Sub 128: WO
1F83h	Request Guarding	ARRAY	Remote control start/stop of guarding. Remote query of the current state	U8	Sub 0: RO Sub 1 - 127: RW Sub 128: WO
1F84h	Device Type Identification	ARRAY	Expected device types for the slaves	U32	Sub 0: RO Sub 1 - 127: RW
1F85h	Vendor Identification	ARRAY	Vendor identifications for the slaves	U32	Sub 0: RO Sub 1 - 127: RW
1F86h	Product Code	ARRAY	Product codes for the slaves	U32	Sub 0: RO Sub 1 - 127: RW
1F87h	Revision Number	ARRAY	Revision numbers for the slaves	U32	Sub 0: RO Sub 1 - 127: RW
1F88h	Serial Number	ARRAY	Expected serial numbers for the slaves	U32	Sub 0: RO Sub 1 - 127: RW
1F89h	Boot Time	VAR	The maximum time between the start of the boot process and the signalling of successful boot of all mandatory NMT slaves. After this time LSS services are initiated.	U32	RW

NMT Start-up, 1F80h

If a device is to be set up as NMT Master, the master functionality must be enabled in this object. It configures the start-up behavior of the device, and how it will manage the slaves.

Note: The Anybus X-gateway CANopen starts up as a slave (bit 0 = 0). For the module to perform as a master, change the value of this bit during configuration and save it to non volatile flash memory by issuing “save” command to subindex 01h in object 1010 (Store Parameters). The setting will take immediate effect, but if not saved, it will be lost at reset or repower.

Bit No.	Value	Description	Notes
0	0	NMT Master functionality is disabled. Ignore the rest of the object, except for bits 1 and 3. Ignore object 1F81h.	Default
	1	NMT Master functionality is enabled. The device is Master	
1	0	Start only explicitly assigned slaves (if bit 3 = 0)	Default
	1	After boot-up, perform the service NMT Start Remote Node All Nodes (if bit 3 = 0)	
2	0	Automatically enter Operational state	Default
	1	Do not enter Operational state automatically. Application will decide when to enter Operational state	
3	0	Start-up of slaves allowed (i.e. allowed to send NMT Start Remote Node command)	Default
	1	Not allowed to send NMT Start Remote Node command. The application will start the slaves	
4	0	If a mandatory slave generates an Error Control Event, treat the slave individually	If bit 6 = 1, ignore bit 4 If object 1F81h, bit 3 = 1, the network must not be restarted, if a mandatory slave could not be contacted.
	1	If a mandatory slave generates an Error Control Event, perform NMT Reset All Nodes (including self)	
5	-	Not implemented	
6	0	If a mandatory slave generates an Error Control Event, treat the slave according to bit 4	
	1	If a mandatory slave generates an Error Control Event, send NMT Stop All Nodes (including self). Ignore bit 4	
7 - 31	-	Reserved (0)	

Slave Assignment, 1F81h

This object defines which slaves the Master should monitor, control and/or configure. One entry is made for each assigned slave, with the subindex corresponding to the slave's Node ID.

Bit No	Value	Description
0	0	Node with this ID is not a slave
	1	Node with this ID is a slave. After configuration the node will be set to Operational
1	-	Reserved
2	0	On an Error Control Event or on detection of a new slave, inform the application, but do NOT configure and start the slave
	1	On an Error Control Event or on detection of a new slave, inform the application and start the process "Start Boot Slave"
3	0	Optional slave. The network may be started even if this node could not be contacted.
	1	Mandatory slave. The network must not be started if this node could not be contacted during the boot slave process
4	-	Not implemented
5	-	Not implemented
6	-	Not implemented
7	0	CANopen device may be used without reset to default
	1	CANopen device shall be reset to factory defaults by issuing a restore to defaults (object 1011h).
8 - 15	-	8 bit value for the RetryFactor
16 - 31	-	16 bit value for the GuardTime If a slave does not answer, the master will retry the request RetryFactor-1 times with an interval of GuardTime. Guarding will be performed only if non zero values are entered for Retry Factor and GuardTime.

Request NMT, 1F82h

Each node on the CANopen network can be controlled individually from the fieldbus application by sending this object. The subindex indicates what nodes the request affects:

Subindex	Description
0	Largest subindex supported (128)
i (with i = 1...127)	Request NMT Service for the slave with Node ID i.
128	Request NMT Service for all nodes

The desired state is given as a numeric value when writing to or reading from the local object dictionary:

Value	Write access	Read Access
0	-	NMT state unknown. The node is not configured and/or no node monitoring is activated.
1	-	CANopen device is missing. The node with this Node ID is configured but the monitoring of the node has failed.
4	STOP remote node	NMT state STOPPED
5	START remote node	NMT state OPERATIONAL
6	RESET NODE	-
7	RESET COMMUNICATION	-
127	Enter PRE-OPERATIONAL	NMT state PRE-OPERATIONAL

The entire network can be started with one command (subindex 128)

Examples

- Node 5 should be transferred to the OPERATIONAL state:
An SDO write access with the value 5 is executed to object 1F82h subindex 5 in the local object dictionary. When an NMT command is sent, data is cleared.
- All the nodes in the network should be transferred to the PRE-OPERATIONAL state:
An SDO write access with the value 127 is executed to object 1F82h subindex 128 in the local object dictionary.

Request Guarding, 1F83h

Guarding can be initiated from the object dictionary in a similar way. Guarding is initiated with the values stored in “Slave Assignment, 1F81h” on page 37, provided that at the same time no parameters are entered for that node as a Heartbeat Consumer

Note: This functionality is only supported in master mode.

Subindex	Description	Access
0	Largest subindex supported (128)	RO
i (with i = 1...127)	Request Guarding for the slave with Node ID i	RW
128	Request Start/Stop Guarding for all nodes.	WO

Value	Write access	Read access
1	Start guarding	Slave is guarded
0	Stop guarding	Slave is not guarded

Example:

- Guarding should be started for node 5 (500 ms, Life Time Factor 3):
An SDO write access with the value 01F40301h is executed to object 1F81h subindex 5 in the local object dictionary. Guarding is activated by an SDO write access with the value 1 to object 1F83h subindex 5 in the local object dictionary.

Bits	Value	Explanation
31 - 16	01F4h (500)	The interval with which node 5 will be guarded
15 - 8	03h	If node 5 does not answer the guarding will be repeated another RetryFactor -1 times (in this case twice)
7 - 0	01h	This value indicates that node 5 is a slave

Device Type Identification, 1F84h

Each node on the CANopen network is checked against its expected device type. The subindex indicates which node is checked:

Subindex	Description
0	Largest subindex supported (127)
i (with i = 1...127)	If the expected device type is not 0 or if the slave is set as mandatory, the module compares expected device type with actual device type (object 1000h, subindex 0) for the slave with Node ID i. If the expected device type is 0, this only gives information about the existence of a node, not which device type it is. If the value is not 0, it is compared to the value read from the node, and boot up of that slave is continued if they match. If they don't match, the slave will stay in state PRE-OPERATIONAL.

Vendor Identification, 1F85h

Each node on the CANopen network is checked against its expected vendor. The subindex indicates which node is checked:

Subindex	Description
0	Largest subindex supported (127)
i (with i = 1...127)	Compares expected vendor with actual vendor (object 1018h, subindex 1) for the slave with Node ID i. Boot up of that slave is continued only if they match. If they don't match, the slave will stay in state PRE-OPERATIONAL.

Product Code, 1F86h

Each node on the CANopen network is checked against its expected product code. The subindex indicates which node is checked. The node in question is only checked if data is other than zero:

Subindex	Description
0	Largest subindex supported (127)
i (with i = 1...127)	Compares expected product code with actual product code (object 1018h, subindex 2) for the slave with Node ID i. Boot up of that slave is continued only if they match. If they don't match, the slave will stay in state PRE-OPERATIONAL.

Revision Number, 1F87h

Each node on the CANopen network is checked against its expected revision number. The revision number includes major and minor revision. For a match to occur the major revision has to be exactly the same and the minor revision of the module has to be greater than or equal to the expected minor revision number. The subindex indicates which node is checked. The node in question is only checked if data is other than zero:

Subindex	Description
0	Largest subindex supported (127)
i (with i = 1...127)	Compares expected revision number with actual revision number (object 1018h, subindex 3) for the slave with Node ID i. Boot up of that slave is continued only if they match according to the description above.

Serial Number, 1F88h

Each node on the CANopen network is checked against its expected serial number. The subindex indicates which node is checked. The node in question is only checked if data is other than zero:

Subindex	Description
0	Largest subindex supported (127)
i (with i = 1...127)	Compares expected serial number with actual serial number (object 1018h, subindex 4) for the slave with Node ID i. Boot up of that slave is continued only if they match. If they don't match, the slave will stay in state PRE-OPERATIONAL.

Boot Time, 1F89h

The network master will wait the assigned time (in ms) for all mandatory slaves to boot. If not all mandatory slaves are ready after this time, the LSS routine will be started, see "LSS Services" on page 30. If the assigned time is 0, the master will wait endlessly.

Value (ms)	Description
0	Default. No time limit for mandatory slaves to boot
> 0	Time limit for mandatory slave to boot

7.3 Vendor Specific Objects

Vendor specific objects are used to configure the PDOs to the shared memory area. One or several generic data object are connected to each PDO. This is configured during the configuration phase.

Application data bytes 0 and 1, i.e. the first two bytes in the input and output buffers, are used for control and status words.

7.3.1 Transmit Buffer

This buffer contains data that is transmitted to the secondary CANopen network.

Index	Subindex	Type	Access	Name	Position in transmit data area (bytes)
2000h	-	STRUCT		Transmit Byte 1-128	2-129 (The first two bytes in the transmit data area are reserved for the Control Word.)
	0	U8	RO	Number of entries (value=128)	
	1	U8	RW	Transmit Byte 1	2
	2	U8	RW	Transmit Byte 2	3

	128	U8	RW	Transmit Byte 128	129
2001h	-	STRUCT		Transmit Byte 129-256	130-257
	0	U8	RO	Number of entries (value=128)	
	1	U8	RW	Transmit Byte 129	130
	2	U8	RW	Transmit Byte 130	131

	128	U8	RW	Transmit Byte 256	257
2002h	-	STRUCT		Transmit Byte 257-384	258-385
	0	U8	RO	Number of entries (value=128)	
	1	U8	RW	Transmit Byte 257	258
	2	U8	RW	Transmit Byte 258	259

	128	U8	RW	Transmit Byte 384	385
2003h	-	STRUCT		Transmit Byte 385-510	386-511
	0	U8	RO	Number of entries (value=126)	
	1	U8	RW	Transmit Byte 385	386
	2	U8	RW	Transmit Byte 386	387

	126	U8	RW	Transmit Byte 510	511
2010h	-	STRUCT		Transmit Word 1-128	2-257
	0	U8	RO	Number of entries (value=128)	
	1	U16	RW	Transmit Word 1	2-3
	2	U16	RW	Transmit Word 2	4-5

	128	U16	RW	Transmit Word 128	256-257
2011h	-	STRUCT		Transmit Word 129-255 area	258-511
	0	U8	RO	Number of entries (value=127)	
	1	U16	RW	Transmit Word 129	258-259
	2	U16	RW	Transmit Word 130	260-261

	127	U16	RW	Transmit Word 255	510-511
2020h	-	STRUCT		Transmit Long 1-128 area	2-511
	0	U8	RO	Number of entries (value=128)	
	1	U32	RW	Transmit Long 1	2-5
	2	U32	RW	Transmit Long 2	6-9

	128	U32	RW	Transmit Long 128	510-511 (the last two bytes are padded with zeroes)

7.3.2 Receive Buffer

This buffer contains data that is received from the secondary CANopen network.

Index	Subindex	Type	Access	Name	Position in receive data area (bytes)
2100h	-	STRUCT		Receive Byte 1-128 area	2-129 (The first two bytes in the receive data area are reserved for the Status Word.)
	0	U8	RO	Number of entries (value=128)	
	1	U8	RW	Receive Byte 1	2
	2	U8	RW	Receive Byte2	3

	128	U8	RW	Receive Byte 128	129
2101h	-	STRUCT		Receive Byte 129-256	130-257
	0	U8	RO	Number of entries (value=128)	
	1	U8	RW	Receive Byte 129	130
	2	U8	RW	Receive Byte 130	131

	128	U8	RW	Receive Byte 256	257
2102h	-	STRUCT		Receive Byte 257-384	258-385
	0	U8	RO	Number of entries (value=128)	
	1	U8	RW	Receive Byte 257	258
	2	U8	RW	Receive Byte 258	259

	128	U8	RW	Receive Byte 384	385
2103h	-	STRUCT		Receive Byte 385-510	386-511
	0	U8	RO	Number of entries (value=126)	
	1	U8	RW	Receive Byte 386	386
	2	U8	RW	Receive Byte 387	387

	126	U8	RW	Receive Byte 511	511
2110h	-	STRUCT		Receive Word 1-128	2-257
	0	U8	RO	Number of entries (value=128)	
	1	U16	RW	Receive Word 1	2-3
	2	U16	RW	Receive Word 2	4-5

	128	U16	RW	Receive Word 128	256-257
2111h	-	STRUCT		Receive Word 129-255 area	258-511
	0	U8	RO	Number of entries (value=127)	
	1	U16	RW	Receive Word 129	258-259
	2	U16	RW	Receive Word 130	260-261

	127	U16	RW	Receive Word 255	510-511
2120h	-	STRUCT		Receive Long 1-128 area	2-511
	0	U8	RO	Number of entries (value=128)	
	1	U32	RW	Receive Long 1	2-5
	2	U32	RW	Receive Long 2	6-9

	128	U32	RW	Receive Long 128	510-511 (the last two bytes are padded with zeroes)

Note 1: The picture shows the Transmit data area. The Receive data area has the same structure, but with indices for byte objects starting at 2100h.

Note 2: The first two bytes are occupied by the control/status word, and are used internally by the X-gateway. These bytes should not be used for data exchange. See also “Control Word” on page 25 and “Status Word” on page 26.

7.3.4 General Fieldbus Parameters

Index range 3000h-300Fh is allocated for general fieldbus parameters.

Index	Subindex	Type	Access	Name and Description	Comment
3000h	0	U16	RW	Input Data Size (size to Modbus RTU)	Valid values: 2-512 ^a , default 16
3001h	0	U16	RW	Output Data Size (size from Modbus RTU)	Valid values: 2-512 ^b , default 16

- a. The first two bytes of the I/O input area are occupied by the Status Word. The rest is available for data exchange on the secondary CANopen (sub)network side, see “I/O Buffer Addresses and Object Dictionary Indices Relation” on page 43 for further information. Also note that the valid data range may differ depending on the slave interface.
- b. The first two bytes of the I/O output area are occupied by the Control Word. The rest is available for data exchange on the secondary CANopen (sub)network side, see “I/O Buffer Addresses and Object Dictionary Indices Relation” on page 43 for further information. Also note that the valid data range may differ depending on the slave interface.

Note: Writing to object 1010h (Store Parameters, see 33), will verify the input/output data sizes, stored in these objects, against the current fieldbus limitations. If the data sizes do not comply, an error will be generated (error code 6600h, see “CANopen Emergency Codes” on page 48).

7.3.5 Modbus RTU Specific Parameters

Index range 3040h - 304Fh is allocated for Modbus RTU specific parameters.

Index	subindex	Type	Access	Name and Description	Extended Information
3040h	0	U16	RW	Offline timeout	Valid values: 0 - 65535

A. Technical Specification

A.1 Protective Earth (PE) Requirements

The product must be connected to protective earth (PE) via the DIN-rail connector in order to achieve proper EMC behavior.

HMS Industrial Networks does not guarantee proper EMC behavior unless these PE requirements are fulfilled.

A.2 Power Supply

Supply Voltage

The gateway requires a regulated 24 V \pm 10% DC power source.

Power Consumption

Typical: 100 mA at 24 V.

Maximum: 150 mA at 24 V

A.3 Environmental Specification

A.3.1 Temperature

Operating

-25° to +55° Celsius

(Test performed according to IEC-60068-2-1 and IEC 60068-2-2.)

Non Operating

-40° to +85° degrees Celsius

(Test performed according to IEC-60068-2-1 and IEC 60068-2-2.)

A.3.2 Relative Humidity

The product is designed for a relative humidity of 5 to 95% non-condensing.

Test performed according to IEC 60068-2-30.

A.4 EMC (CE) Compliance

EMC compliance testing has been conducted according to the Electromagnetic Compatibility Directive 2004/108/EC. For more information please consult the EMC compliance document, see product/support pages for Anybus X-gateway CANopen - Modbus RTU at www.anybus.com.

A.5 UL and ATEX Certification

The Anybus X-gateway CANopen - Modbus RTU is HazLoc, UL and cUL certified according to file no. E203255. For more information please consult www.ul.com.

ATEX testing has been conducted according to Demko 11 ATEX 1062548. For more information please see product/support pages for Anybus X-gateway CANopen - Modbus RTU at www.anybus.com.

B. Status LED Timing Diagrams

The LEDs on the front of the module change their behavior according to the status of the module. This appendix gives the timing diagrams for the different indications, described in “Status LEDs” on page 7.

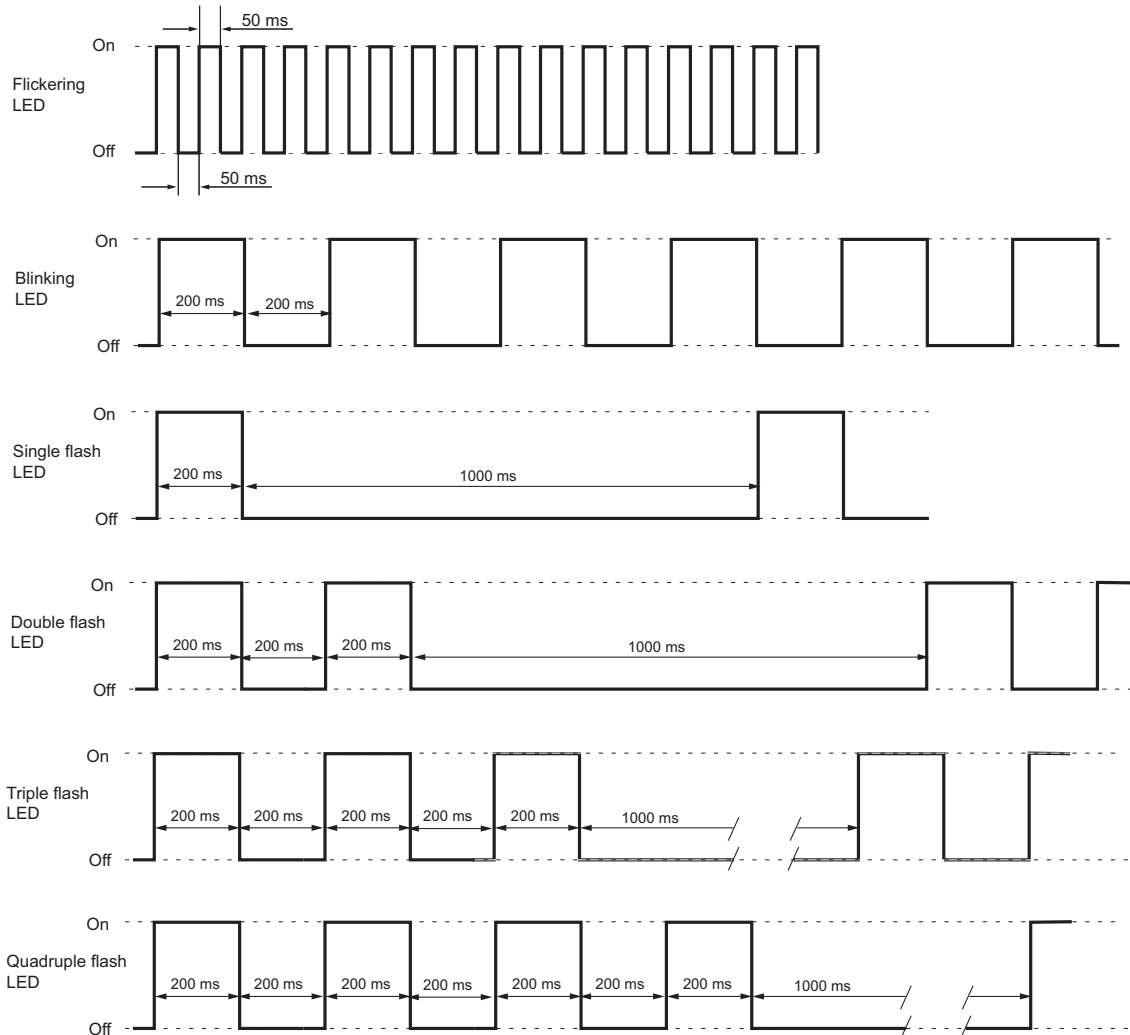

When LSS services are in progress, both the ERR LED (red) and the RUN LED (green) are flickering.

C. CANopen Emergency Codes

Below is a list of the CANopen emergency codes that can be produced by the Anybus X-gateway CANopen. The error codes, that have been produced, can be read from the list in the Communication Profile Object at index 1003h, see 32.

Error Code	Description
0000h	Error reset or no error.
6161h	Software error, only valid in master mode. For additional information, see table below.
6600h	Hardware error
8110h	CAN overrun (objects lost).
8120h	CAN in error passive mode.
8130h	Life guard error or heartbeat error.
8140h	Recovered from bus off.
8210h	PDO not processed due to length error.
8220h	PDO length exceeded.
FF10h	(Only valid in slave mode) The control word has been set to no longer allow the module to enter OPERATIONAL state, but the sub-network is in OPERATIONAL state or a CANopen master attempts to set the module in OPERATIONAL state, while the control word is set not to allow OPERATIONAL state.

These codes conform to the CANopen standard.

Software error codes (6161h)

When an emergency code 6161h is produced, additional information is stored in the Communication Profile Object, index 1003h.

31		16 15		0
Additional Information		Emergency error code		
Error Code	Node Id (if available)	61h	61h	

Error code	Description
00h	No software error detected.
01h	Tag for CMT record not available.
02h	Cache management inconsistent.
03h	SDO could not be transmitted.
04h	Configuration entry inconsistent.
05h	Check sum error.
06h	Data could not be written to non-volatile memory.
07h	SDO timeout.
08h	SDO error.