

## ABZT52B2V0-HF Thru. ABZT52B75-HF

RoHS Device  
Halogen Free



### Features

- Planar die construction.
- General purpose, medium current.
- Ideally suited for automated assembly processes.
- AEC-Q101 Qualified

### Mechanical data

- Case: Molded plastic, SOD-123

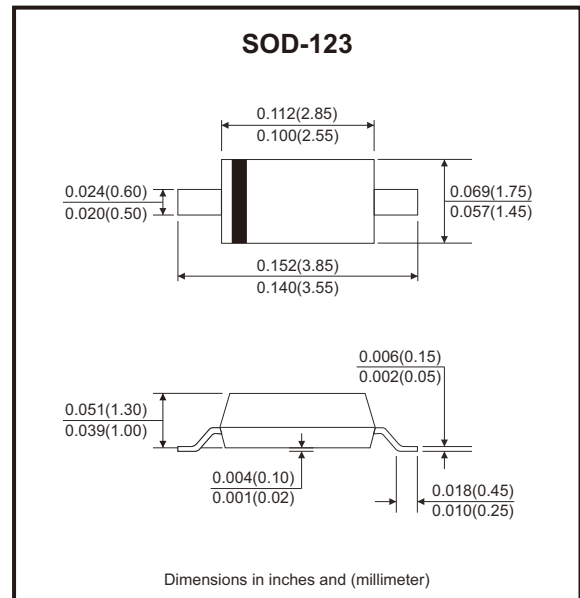

### Circuit Diagram



### Maximum Ratings (TA=25°C unless otherwise noted)

Parameter	Symbol	Value	Unit
Forward voltage @ IF=10mA	V <sub>F</sub>	0.9	V
Power dissipation	P <sub>D</sub>	500	mW
Thermal resistance, junction to ambient air	R <sub>θJA</sub>	305	°C/W
Thermal resistance, junction to case	R <sub>θJC</sub>	180	°C/W
Junction temperature	T <sub>J</sub>	150	°C
Storage temperature range	T <sub>STG</sub>	-65 to +150	°C

Note: 1. Device mounted on ceramic PCB; 7.6mm x 9.4mm x 0.87mm with pad areas 25mm<sup>2</sup>.  
 2. Short duration test pulse used to minimize self-heating effect.  
 3. f = 1 KHz

## Electrical Characteristics (TA=25°C unless otherwise noted)

Part Number	Zener Voltage				Maximum Zener Impedance			Maximum Reverse Current		Typical Temperature Coefficient @ IZTC mV/°C		Test current IZTC (mA)	Marking Code
	VZT @ IZT			IZT	ZZT@IZT	Zzk@Izk	Izk	IR @ VR		Min.	Max.		
	Nom(V)	Min(V)	Max(V)	(mA)	(Ω)	(Ω)	(mA)	(μA)	(V)				
ABZT52B2V0-HF	2.0	1.96	2.04	5.0	100	1000	0.5	120	0.5	-3.5	0	5	WX•
ABZT52B2V2-HF	2.2	2.156	2.244	5.0	100	1000	0.5	120	0.7	-3.5	0	5	WY•
ABZT52B2V4-HF	2.4	2.35	2.45	5.0	85	600	1.0	45	1.0	-3.5	0	5	W1•
ABZT52B2V7-HF	2.7	2.65	2.75	5.0	83	500	1.0	18	1.0	-3.5	0	5	W2•
ABZT52B3V0-HF	3.0	2.94	3.06	5.0	95	500	1.0	9	1.0	-3.5	0	5	W3•
ABZT52B3V3-HF	3.3	3.23	3.37	5.0	95	500	1.0	4.5	1.0	-3.5	0	5	W4•
ABZT52B3V6-HF	3.6	3.53	3.67	5.0	95	500	1.0	4.5	1.0	-3.5	0	5	W5•
ABZT52B3V9-HF	3.9	3.82	3.98	5.0	95	500	1.0	2.7	1.0	-3.5	0	5	W6•
ABZT52B4V3-HF	4.3	4.21	4.39	5.0	95	500	1.0	2.7	1.0	-3.5	0	5	W7•
ABZT52B4V7-HF	4.7	4.61	4.79	5.0	78	500	1.0	2.7	2.0	-3.5	0	5	W8•
ABZT52B5V1-HF	5.1	5.00	5.20	5.0	60	480	1.0	1.8	2.0	-2.7	1.2	5	W9•
ABZT52B5V6-HF	5.6	5.49	5.71	5.0	40	400	1.0	0.9	2.0	-2	2.5	5	WA•
ABZT52B6V2-HF	6.2	6.08	6.32	5.0	10	200	1.0	2.7	4.0	0.4	3.7	5	WB•
ABZT52B6V8-HF	6.8	6.66	6.94	5.0	8	150	1.0	1.8	4.0	1.2	4.5	5	WC•
ABZT52B7V5-HF	7.5	7.35	7.65	5.0	7	50	1.0	0.9	5.0	2.5	5.3	5	WD•
ABZT52B8V2-HF	8.2	8.04	8.36	5.0	7	50	1.0	0.63	5.0	3.2	6.2	5	WE•
ABZT52B9V1-HF	9.1	8.92	9.28	5.0	10	50	1.0	0.45	6.0	3.8	7.0	5	WF•
ABZT52B10-HF	10	9.80	10.20	5.0	15	70	1.0	0.18	7.0	4.5	8.0	5	WG•
ABZT52B11-HF	11	10.78	11.22	5.0	20	70	1.0	0.09	8.0	5.4	9.0	5	WH•
ABZT52B12-HF	12	11.76	12.24	5.0	20	90	1.0	0.09	8.0	6.0	10.0	5	WI•
ABZT52B13-HF	13	12.74	13.26	5.0	25	110	1.0	0.09	8.0	7.0	11.0	5	WJ•
ABZT52B15-HF	15	14.70	15.30	5.0	30	110	1.0	0.045	10.5	9.2	13.0	5	WK•
ABZT52B16-HF	16	15.68	16.32	5.0	40	170	1.0	0.045	11.2	10.4	14.0	5	WL•
ABZT52B18-HF	18	17.64	18.36	5.0	50	170	1.0	0.045	12.6	12.4	16.0	5	WM•
ABZT52B20-HF	20	19.60	20.40	5.0	50	220	1.0	0.045	14.0	14.4	18.0	5	WN•
ABZT52B22-HF	22	21.56	22.44	5.0	55	220	1.0	0.045	15.4	16.4	20.0	5	WO•
ABZT52B24-HF	24	23.52	24.48	5.0	80	220	1.0	0.045	16.8	18.4	22.0	5	WP•
ABZT52B27-HF	27	26.46	27.54	2.0	80	250	1.0	0.045	18.9	21.4	25.3	2	WQ•
ABZT52B30-HF	30	29.40	30.60	2.0	80	250	1.0	0.045	21.0	24.4	29.4	2	WR•
ABZT52B33-HF	33	32.34	33.66	2.0	80	250	1.0	0.045	23.0	27.4	33.4	2	WS•

Company reserves the right to improve product design , functions and reliability without notice.

REV:A

## Electrical Characteristics ( $T_A=25^{\circ}\text{C}$ unless otherwise noted)

Part Number	Zener Voltage			Maximum Zener Impedance			Maximum Reverse Current		Typical Temperature Coefficient @ $I_{ZTC}$ mV/ $^{\circ}\text{C}$		Test current $I_{ZTC}$ (mA)	Marking Code	
	$V_{ZT}$ @ $I_{ZT}$		$I_{ZT}$	$Z_{ZT}@I_{ZT}$	$Z_{ZK}@I_{ZK}$	$I_{ZK}$	$I_R$ @ $V_R$		Min.	Max.			
	Nom(V)	Min(V)	Max(V)	(mA)	( $\Omega$ )	( $\Omega$ )	(mA)	( $\mu\text{A}$ )	(V)				
ABZT52B36-HF	36	35.28	36.72	2.0	90	250	1.0	0.045	25.2	30.4	37.4	2	WT•
ABZT52B39-HF	39	38.22	39.78	2.0	90	300	1.0	0.045	27.3	33.4	41.2	2	WU•
ABZT52B43-HF	43	42.14	43.86	2.0	100	700	1.0	0.045	30.1	10.0	12.0	5	WV•
ABZT52B47-HF	47	46.06	47.94	2.0	100	750	1.0	0.045	33.0	10.0	12.0	5	WW•
ABZT52B51-HF	51	49.98	52.02	2.0	100	750	1.0	0.045	35.7	10.0	12.0	5	X1•
ABZT52B56-HF	56	54.88	57.12	2.0	200	400	0.5	0.045	39.2	10.0	12.0	5	X2•
ABZT52B62-HF	62	60.76	63.24	2.0	215	423	0.5	0.045	43.4	10.0	12.0	5	X3•
ABZT52B68-HF	68	66.64	69.36	2.0	240	447	0.5	0.045	47.6	10.0	12.0	5	X4•
ABZT52B75-HF	75	73.50	76.50	2.0	255	470	0.5	0.045	52.5	10.0	12.0	5	X5•

## Rating and Characteristic Curves (ABZT52B2V0-HF Thru. ABZT52B75-HF)

Fig.1 - Power Dissipation vs Ambient Temperature

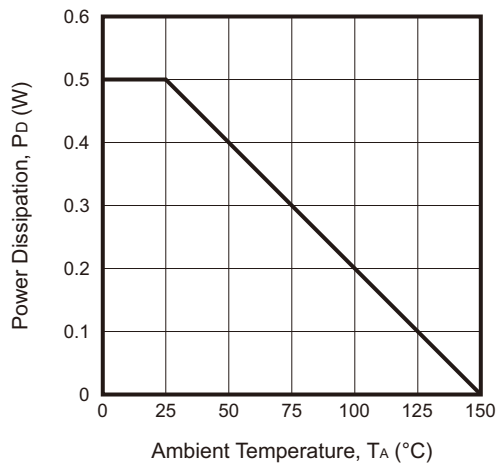
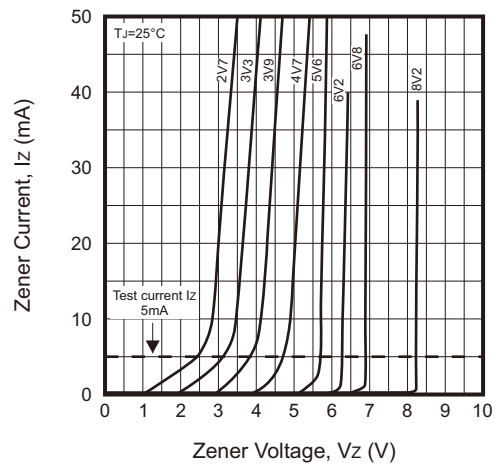

Fig.2 - Zener Breakdown Characteristics



## Rating and Characteristic Curves (ABZT52B2V0-HF Thru. ABZT52B75-HF)

Fig.3 - Zener Breakdown Characteristics

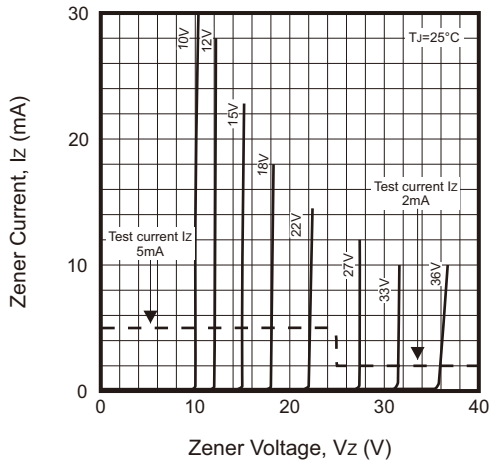

Fig.4 - Zener Breakdown Characteristics

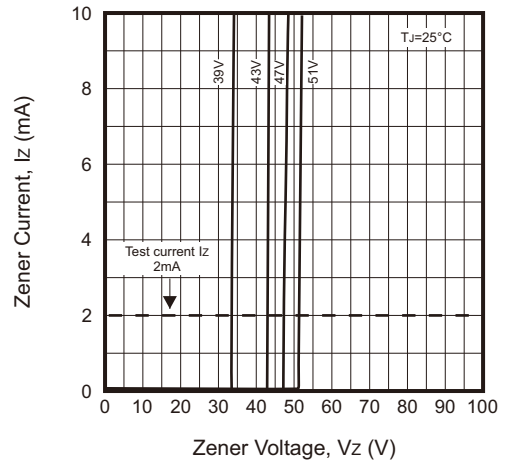

Fig.5 - Junction Capacitance vs Nominal Zener Voltage

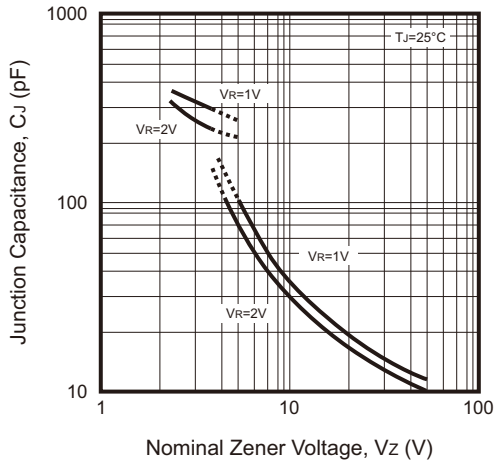

Fig.6 - Typical Temperature Coefficient of Zener Voltage

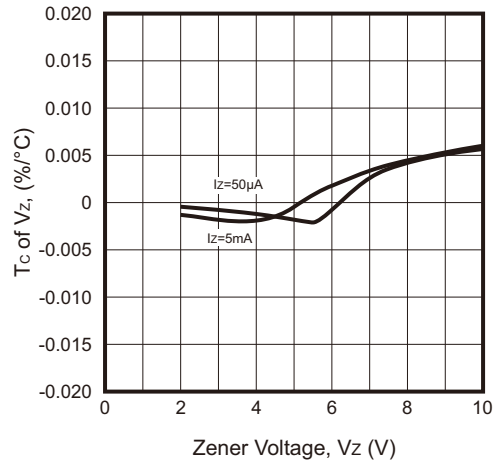
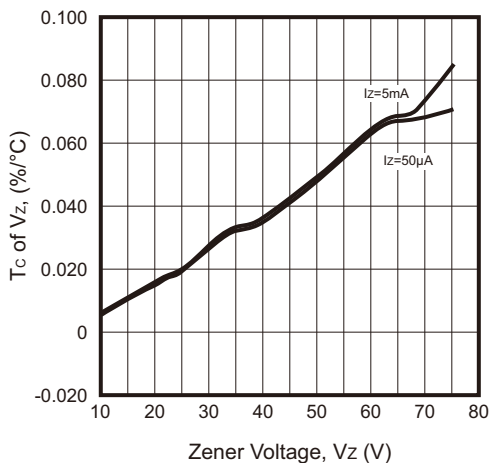
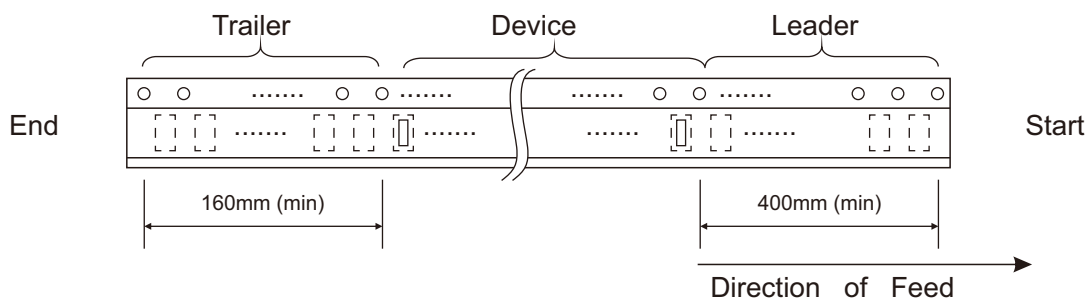
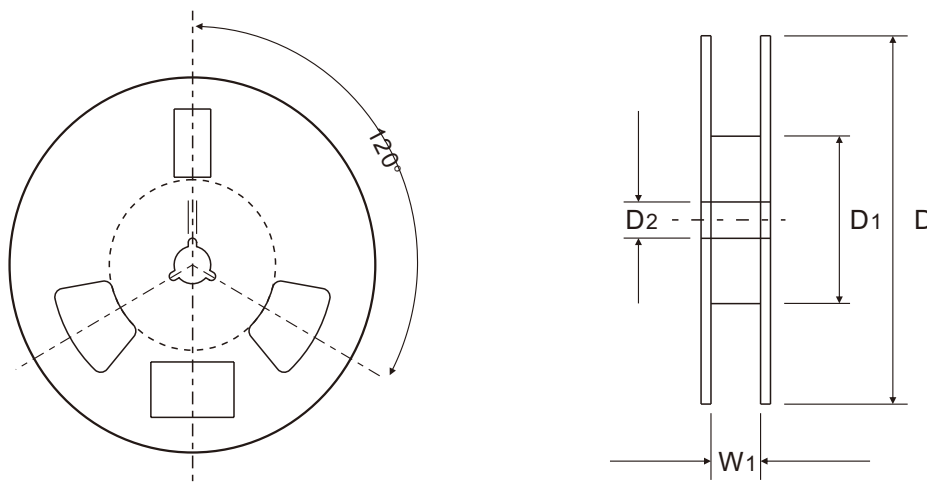

Fig.7 - Typical Temperature Coefficient of Zener Voltage



## Reel Taping Specification



SOD-123	SYMBOL	A	B	C	d	D	D1	D2
	(mm)	1.85 ± 0.10	3.94 ± 0.10	1.57 ± 0.10	1.55 ± 0.05	178.00 ± 1.00	54.00 ± 0.50	13.00 ± 0.50
	(inch)	0.073 ± 0.004	0.155 ± 0.004	0.062 ± 0.004	0.061 ± 0.002	7.008 ± 0.039	2.126 ± 0.020	0.512 ± 0.020

SOD-123	SYMBOL	E	F	P	P1	P0	W	W1
	(mm)	1.75 ± 0.10	3.50 ± 0.05	4.00 ± 0.10	2.00 ± 0.05	4.00 ± 0.10	8.00 + 0.30 - 0.10	9.50 ± 1.00
	(inch)	0.069 ± 0.004	0.138 ± 0.002	0.157 ± 0.004	0.079 ± 0.002	0.157 ± 0.004	0.315 + 0.012 - 0.004	0.374 ± 0.039

Company reserves the right to improve product design, functions and reliability without notice. REV:A