

# ABZT52C2V0-HF Thru. ABZT52C75-HF

RoHS Device  
Halogen Free



## Features

- Planar die construction.
- 500mW power dissipation on ceramic PCB.
- General purpose, medium current.
- Ideally suited for automated assembly processes.
- The plastic material carries U/L recognition 94V-0.
- AEC-Q101 Qualified

## Mechanical data

- Case: Molded plastic, SOD-123

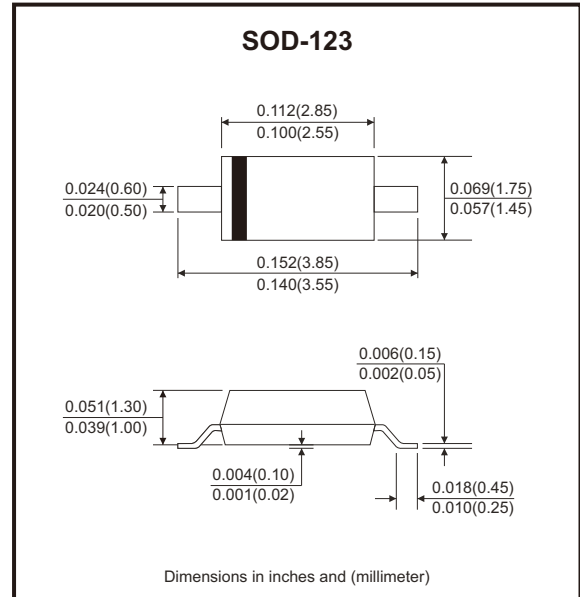

## Circuit Diagram



## Maximum Ratings (TA=25°C unless otherwise noted)

Parameter	Symbol	Value	Unit
Forward voltage @ IF=10mA	V <sub>F</sub>	0.9	V
Power dissipation	P <sub>D</sub>	500	mW
Thermal resistance, junction to ambient air	R <sub>θJA</sub>	305	°C/W
Junction temperature	T <sub>J</sub>	150	°C
Storage temperature range	T <sub>STG</sub>	-65 to +150	°C

Note: 1. Device mounted on ceramic PCB; 7.6mm x 9.4mm x 0.87mm with pad areas 25mm<sup>2</sup>.  
 2. Short duration test pulse used to minimize self-heating effect.  
 3. f = 1 KHz

## Electrical Characteristics (TA=25°C unless otherwise noted)

Part Number	Zener Voltage				Maximum Zener Impedance			Maximum Reverse Current		Typical Temperature Coefficient @ IZTC mV/°C		Test current IZTC (mA)	Marking Code
	VZT @ IZT			IZT	ZZT@IZT	Zzk@Izk	Izk	IR @ VR		Min.	Max.		
	Nom(V)	Min(V)	Max(V)	(mA)	(Ω)	(Ω)	(mA)	(μA)	(V)				
ABZT52C2V0-HF	2.0	1.96	2.04	5.0	100	600	1.0	150	1.0	-3.5	0	5	WY
ABZT52C2V4-HF	2.4	2.20	2.60	5.0	100	600	1.0	50	1.0	-3.5	0	5	WX
ABZT52C2V7-HF	2.7	2.50	2.90	5.0	100	600	1.0	20	1.0	-3.5	0	5	W1
ABZT52C3V0-HF	3.0	2.80	3.20	5.0	95	600	1.0	10	1.0	-3.5	0	5	W2
ABZT52C3V3-HF	3.3	3.10	3.50	5.0	95	600	1.0	5.0	1.0	-3.5	0	5	W3
ABZT52C3V6-HF	3.6	3.40	3.80	5.0	90	600	1.0	5.0	1.0	-3.5	0	5	W4
ABZT52C3V9-HF	3.9	3.70	4.10	5.0	90	600	1.0	3.0	1.0	-3.5	0	5	W5
ABZT52C4V3-HF	4.3	4.00	4.60	5.0	90	600	1.0	3.0	1.0	-3.5	0	5	W6
ABZT52C4V7-HF	4.7	4.40	5.00	5.0	80	500	1.0	3.0	2.0	-3.5	0	5	W7
ABZT52C5V1-HF	5.1	4.80	5.40	5.0	60	480	1.0	2.0	2.0	-2.7	1.2	5	W8
ABZT52C5V6-HF	5.6	5.20	6.00	5.0	40	400	1.0	1.0	2.0	-2	2.5	5	W9
ABZT52C6V2-HF	6.2	5.80	6.60	5.0	10	150	1.0	3.0	4.0	0.4	3.7	5	WA
ABZT52C6V8-HF	6.8	6.40	7.20	5.0	15	80	1.0	2.0	4.0	1.2	4.5	5	WB
ABZT52C7V5-HF	7.5	7.00	7.90	5.0	15	80	1.0	1.0	5.0	2.5	5.3	5	WC
ABZT52C8V2-HF	8.2	7.70	8.70	5.0	15	80	1.0	0.7	5.0	3.2	6.2	5	WD
ABZT52C9V1-HF	9.1	8.50	9.60	5.0	15	100	1.0	0.5	6.0	3.8	7.0	5	WE
ABZT52C10-HF	10	9.40	10.60	5.0	20	150	1.0	0.2	7.0	4.5	8.0	5	WF
ABZT52C11-HF	11	10.40	11.60	5.0	20	150	1.0	0.1	8.0	5.4	9.0	5	WG
ABZT52C12-HF	12	11.40	12.70	5.0	25	150	1.0	0.1	8.0	6.0	10.0	5	WH
ABZT52C13-HF	13	12.40	14.10	5.0	30	170	1.0	0.1	8.0	7.0	11.0	5	WI
ABZT52C15-HF	15	13.80	15.60	5.0	30	200	1.0	0.1	10.5	9.2	13.0	5	WJ
ABZT52C16-HF	16	15.30	17.10	5.0	40	200	1.0	0.1	11.2	10.4	14.0	5	WK
ABZT52C18-HF	18	16.80	19.10	5.0	45	225	1.0	0.1	12.6	12.4	16.0	5	WL
ABZT52C20-HF	20	18.80	21.20	5.0	55	225	1.0	0.1	14.0	14.4	18.0	5	WM
ABZT52C22-HF	22	20.80	23.30	5.0	55	250	1.0	0.1	15.4	16.4	20.0	5	WN
ABZT52C24-HF	24	22.80	25.60	5.0	70	250	1.0	0.1	16.8	18.4	22.0	5	WO
ABZT52C27-HF	27	25.10	28.90	2.0	80	300	0.5	0.1	18.9	21.4	25.3	2	WP
ABZT52C30-HF	30	28.00	32.00	2.0	80	300	0.5	0.1	21.0	24.4	29.4	2	WQ
ABZT52C33-HF	33	31.00	35.00	2.0	80	325	0.5	0.1	23.1	27.4	33.4	2	WR
ABZT52C36-HF	36	34.00	38.00	2.0	90	350	0.5	0.1	25.2	30.4	37.4	2	WS

Company reserves the right to improve product design , functions and reliability without notice.

REV:A

## Electrical Characteristics (TA=25°C unless otherwise noted)

Part Number	Zener Voltage				Maximum Zener Impedance			Maximum Reverse Current		Typical Temperature Coefficient @ I <sub>ZTC</sub> mV/°C		Test current I <sub>ZTC</sub> (mA)	Marking Code
	V <sub>ZT</sub> @ I <sub>ZT</sub>			I <sub>ZT</sub>	Z <sub>ZT</sub> @I <sub>ZT</sub>	Z <sub>ZK</sub> @I <sub>ZK</sub>	I <sub>ZK</sub>	I <sub>R</sub> @ V <sub>R</sub>		Min.	Max.		
	Nom(V)	Min(V)	Max(V)	(mA)	(Ω)	(Ω)	(mA)	(μA)	(V)				
ABZT52C39-HF	39	37.00	41.00	2.0	130	350	0.5	0.1	27.3	33.4	41.2	2	WT
ABZT52C43-HF	43	40.00	46.00	2.0	100	700	1.0	0.1	32.0	10.0	12.0	5	WU
ABZT52C47-HF	47	44.00	50.00	2.0	100	750	1.0	0.1	35.0	10.0	12.0	5	WV
ABZT52C51-HF	51	48.00	54.00	2.0	100	750	1.0	0.1	38.0	10.0	12.0	5	WW
ABZT52C56-HF	56	53.20	58.80	2.0	200	400	0.5	0.045	39.2	10.0	12.0	5	WX
ABZT52C62-HF	62	58.90	65.10	2.0	215	423	0.5	0.045	43.4	10.0	12.0	5	6E
ABZT52C68-HF	68	64.60	71.40	2.0	240	447	0.5	0.045	47.6	10.0	12.0	5	6F
ABZT52C75-HF	75	71.25	78.75	2.0	255	470	0.5	0.045	52.5	10.0	12.0	5	6H

## Rating and Characteristic Curves (ABZT52C2V0-HF Thru. ABZT52C75-HF)

Fig.1 - Power Dissipation vs Ambient Temperature

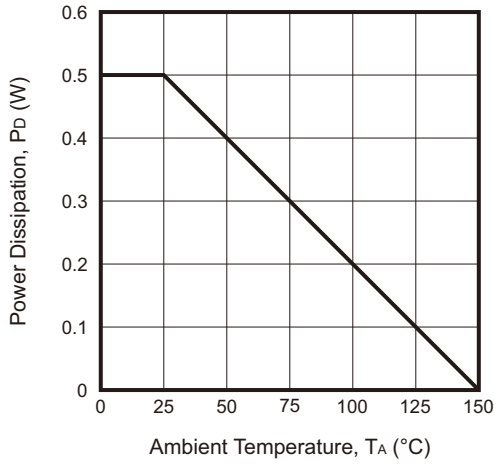

Fig.2 - Zener Breakdown Characteristics

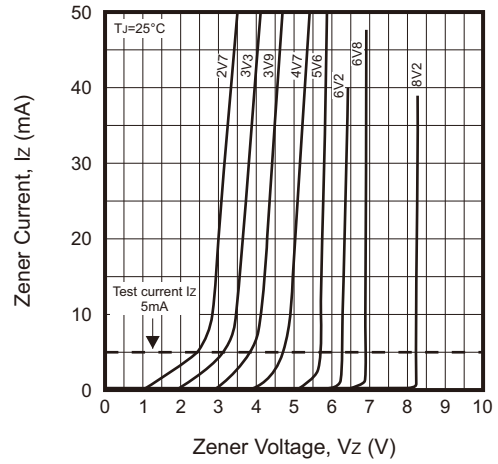

Fig.3 - Zener Breakdown Characteristics

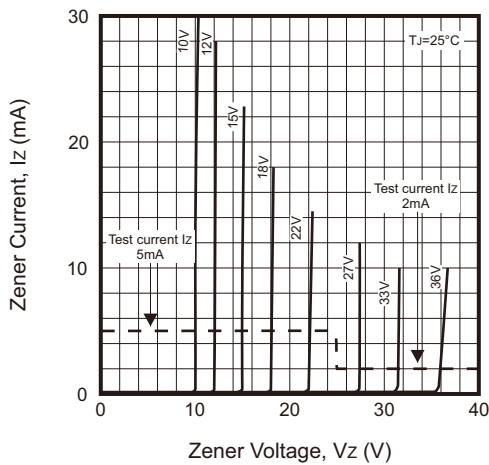

Fig.4 - Zener Breakdown Characteristics

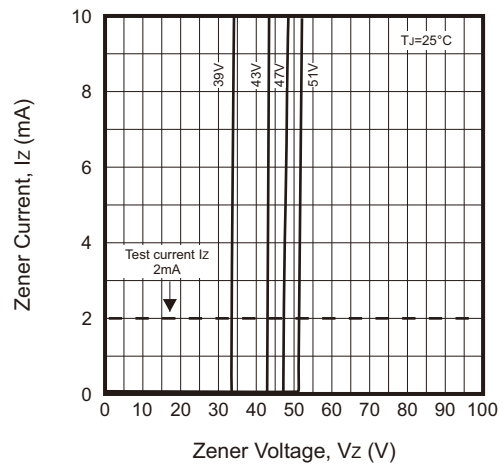
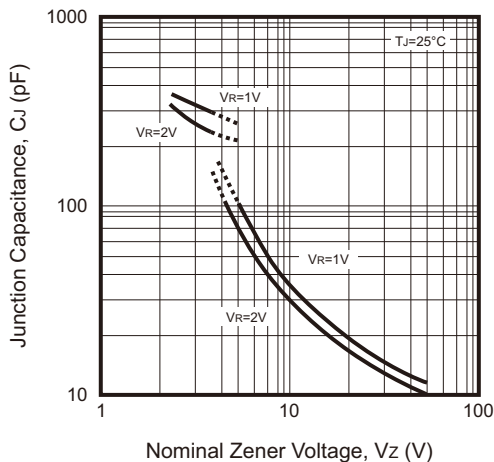
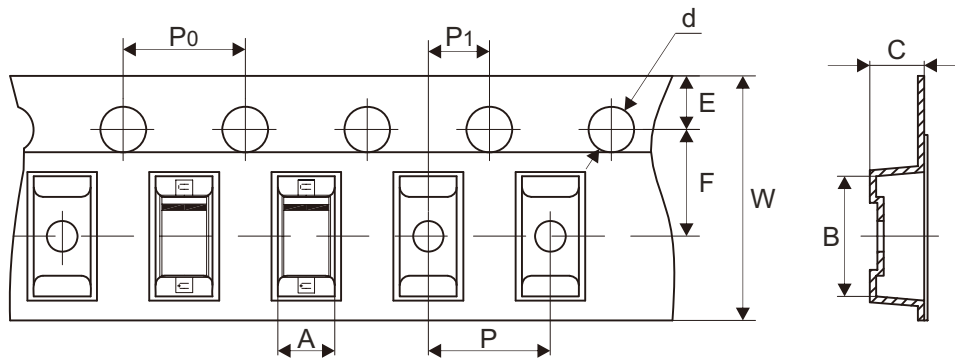

Fig.5 - Junction Capacitance vs Nominal Zener Voltage



## Reel Taping Specification



SOD-123	SYMBOL	A	B	C	d	D	D1	D2
	(mm)	1.85 ± 0.10	3.94 ± 0.10	1.57 ± 0.10	1.55 ± 0.05	178.00 ± 1.00	54.00 ± 0.50	13.00 ± 0.50
	(inch)	0.073 ± 0.004	0.155 ± 0.004	0.062 ± 0.004	0.061 ± 0.002	7.008 ± 0.039	2.126 ± 0.020	0.512 ± 0.020

SOD-123	SYMBOL	E	F	P	P1	P0	W	W1
	(mm)	1.75 ± 0.10	3.50 ± 0.05	4.00 ± 0.10	2.00 ± 0.05	4.00 ± 0.10	8.00 + 0.30 - 0.10	9.50 ± 1.00
	(inch)	0.069 ± 0.004	0.138 ± 0.002	0.157 ± 0.004	0.079 ± 0.002	0.157 ± 0.004	0.315 + 0.012 - 0.004	0.374 ± 0.039

Company reserves the right to improve product design, functions and reliability without notice. REV:A