

## ACDBQC0230R-HF High-Reliability and High-Performance

**$I_o = 200 \text{ mA}$**   
 **$V_R = 30 \text{ Volts}$**   
**RoHS Device**  
**Halogen Free**

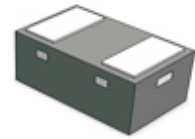

### Features

- Low reverse current.
- Designed for mounting on small surface.
- Extremely thin / leadless package.
- Majority carrier conduction.
- AEC-Q101 Qualified.

### Mechanical data

- Case: 0402C/SOD-923F standard package, molded plastic.
- Terminals: Gold plated, solderable per MIL-STD-750, method 2026.
- Polarity: Indicated by cathode band.
- Mounting position: Any.
- Weight: 0.001 grams (approx.).

### Circuit Diagram

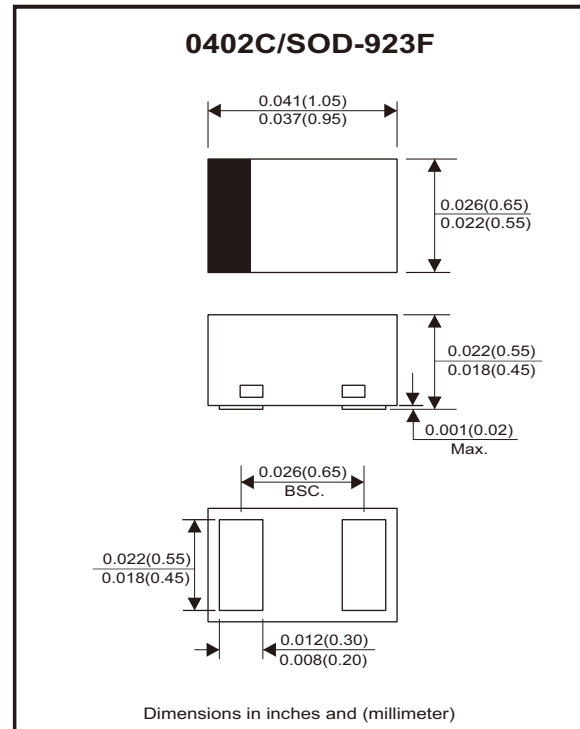

### Maximum Rating (at $T_A=25^\circ\text{C}$ unless otherwise noted)

Parameter	Conditions	Symbol	Min	Typ	Max	Unit
Repetitive peak reverse voltage		$V_{RRM}$			35	V
Reverse voltage		$V_R$			30	V
Average forward current		$I_o$			200	mA
Forward current, surge peak	8.3ms single half sine-wave superimposed on rate load (JEDEC method)	$I_{FSM}$			1	A
Power dissipation		$P_D$			125	mW
Junction temperature		$T_j$			+125	$^\circ\text{C}$
Storage temperature range		$T_{STG}$	-40		+125	$^\circ\text{C}$

### Electrical Characteristics (at $T_A=25^\circ\text{C}$ unless otherwise noted)

Parameter	Conditions	Symbol	Min	Typ	Max	Unit
Forward voltage	$I_F = 200\text{mA}$	$V_F$			0.6	V
Reverse current	$V_R = 10\text{V}$	$I_R$			1	$\mu\text{A}$
Reverse breakdown voltage	$I_B = 0.01\text{mA}$	$V_B$	40			V

## Rating and Characteristic Curves (ACDBQC0230R-HF)

Fig.1 - Forward Characteristics

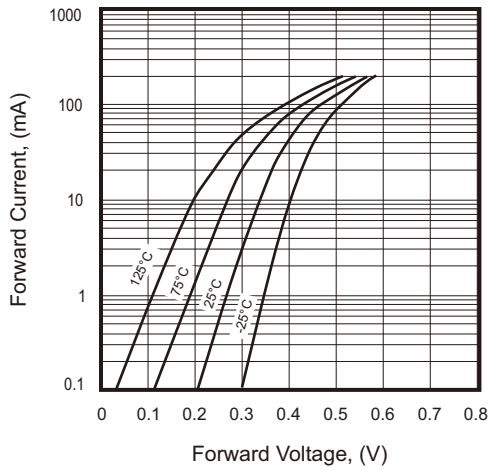

Fig.2 - Reverse Characteristics

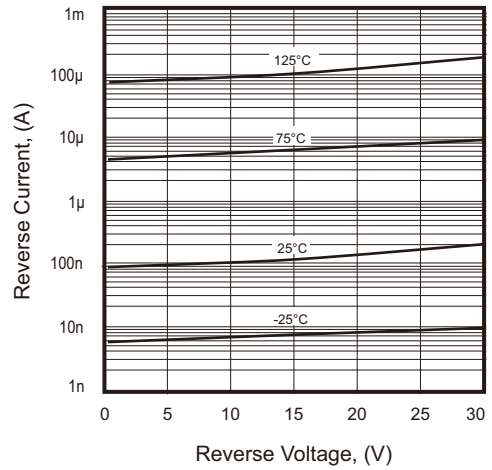

Fig.3 - Capacitance Between Terminals Characteristics

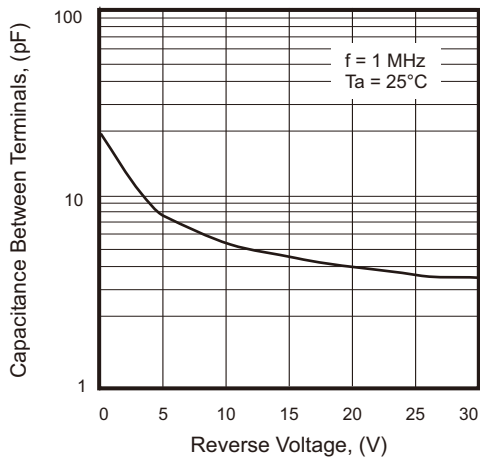

Fig.4 - Current Derating Curve

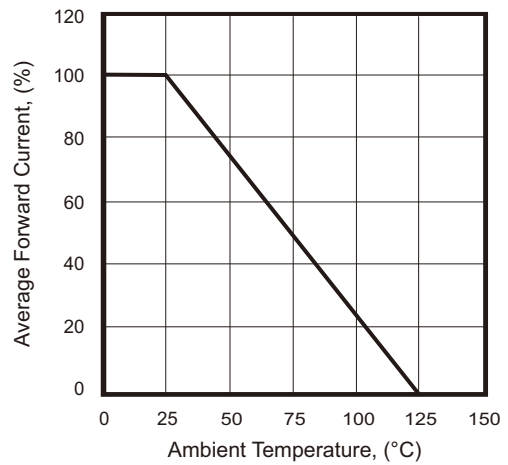

Fig.5 - VF Dispersion Map

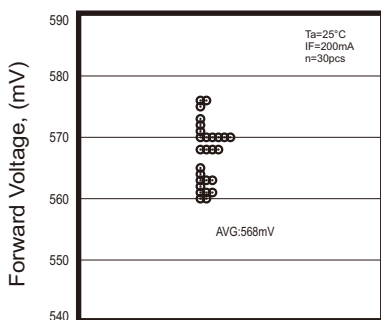

Fig.6 - IR Dispersion Map

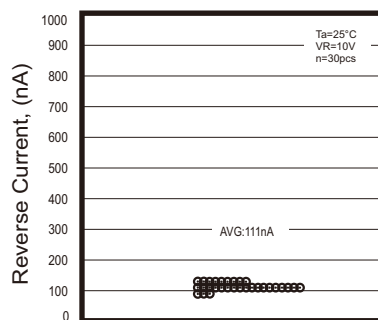
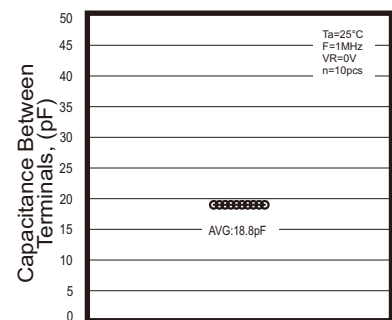
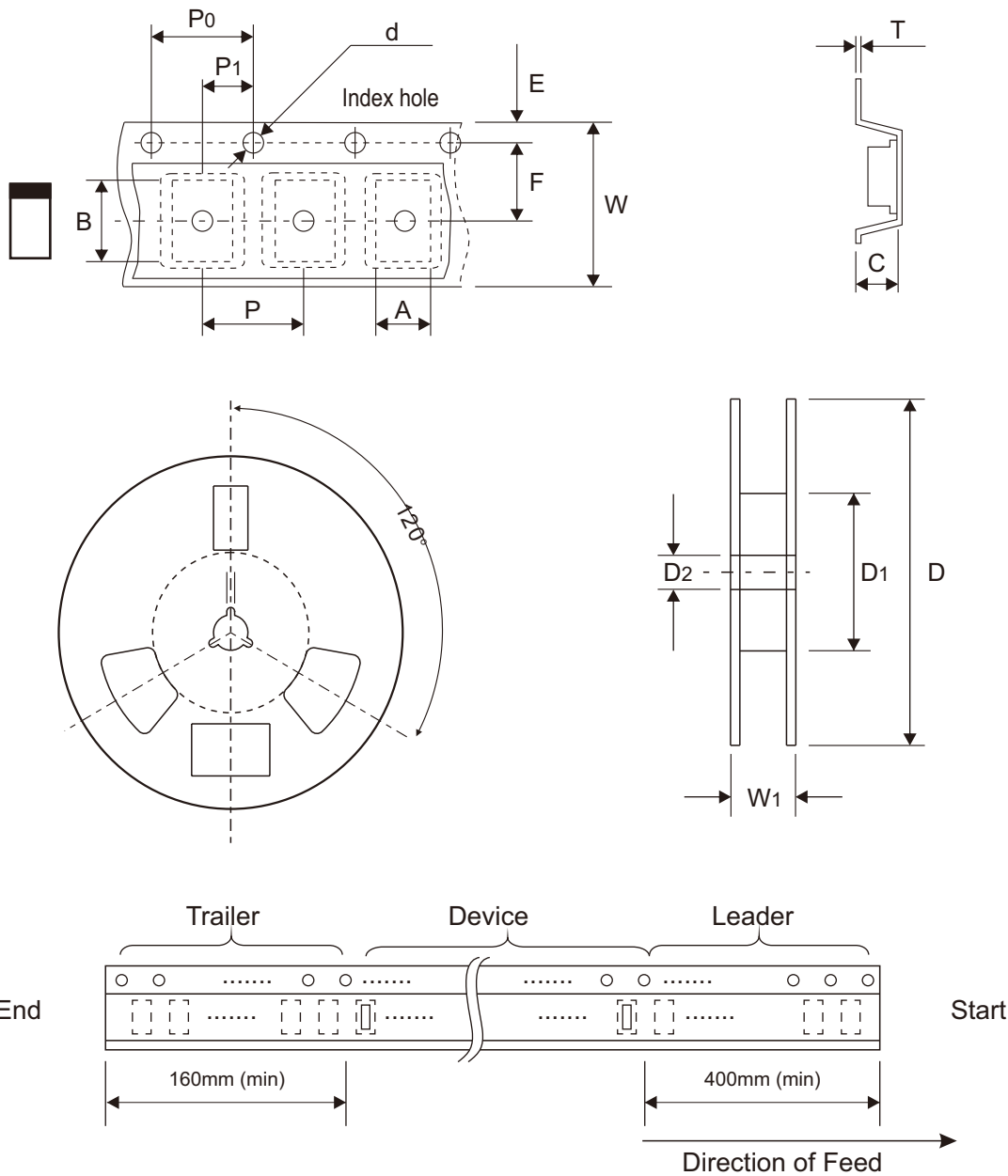

Fig.7 - CT Dispersion Map



## Reel Taping Specification



0402C (SOD-923F)	SYMBOL	A	B	C	d	D	D1	D2
	(mm)	0.75 ± 0.05	1.17 ± 0.05	0.65 ± 0.05	1.50 + 0.10 - 0.00	178.00 ± 1.00	60.00 ± 0.50	13.50 ± 0.20
	(inch)	0.030 ± 0.002	0.046 ± 0.002	0.026 ± 0.002	0.059 + 0.004 - 0.000	7.008 ± 0.039	2.362 ± 0.020	0.531 ± 0.008

0402C (SOD-923F)	SYMBOL	E	F	P	P0	P1	T	W	W1
	(mm)	1.75 ± 0.10	3.50 ± 0.10	4.00 ± 0.10	4.00 ± 0.10	2.00 ± 0.10	0.20 + 0.02 - 0.05	8.00 ± 0.20	12.00 + 0.50 - 0.00
	(inch)	0.069 ± 0.004	0.138 ± 0.004	0.157 ± 0.004	0.157 ± 0.004	0.079 ± 0.004	0.008 + 0.001 - 0.002	0.315 ± 0.008	0.472 + 0.020 - 0.000