

## ACHS-7121/7122/7123

### Fully Integrated, Hall Effect-Based Linear Current Sensor IC with 3 kV<sub>RMS</sub> Isolation and Low-Resistance Current Conductor

#### Overview

The Broadcom<sup>®</sup> ACHS-7121/7122/7123 product series is a fully integrated Hall Effect-based isolated linear current sensor device family designed for AC or DC current sensing in industrial, commercial, and communications systems. Each of the ACHS-7121/7122/7123 consists of a precise, low-offset, linear Hall circuit with a copper conduction path located near the surface of the die. Applied current flowing through this copper conduction path generates a magnetic field that the Hall IC converts into a proportional voltage. Device accuracy is optimized through the close proximity of the magnetic signal to the Hall transducer.

A precise, proportional voltage is provided by the low-offset, chopper-stabilized CMOS Hall IC, which is programmed for accuracy after packaging. The output of the device has a positive slope ( $>V_{OUT(Q)}$ ) when an increasing current flows through the primary copper conduction path (from pins 1 and 2, to pins 3 and 4), which is the path used for current sampling.

The internal resistance of this conductive path is 0.7 m $\Omega$  typical, providing low-power loss. The terminals of the conductive path are electrically isolated from the signal leads (pins 5 through 8). This performance is delivered in a compact, surface mountable, SO-8 package that meets worldwide regulatory safety standards.

Part Number	Current Range	Sensitivity
ACHS-7121	$\pm 10A$	185 mV/A
ACHS-7122	$\pm 20A$	100 mV/A
ACHS-7123	$\pm 30A$	66 mV/A

**CAUTION!** It is advised that normal static precautions be taken in handling and assembly of this component to prevent damage and/or degradation which may be induced by ESD. The components featured in this data sheet are not to be used in military or aerospace applications or environments. The component is not AEC-Q100 qualified and not recommended for automotive applications.

#### Features

- Wide operating temperature:  $-40^{\circ}C$  to  $110^{\circ}C$
- Primary conductor resistance: 0.7 m $\Omega$  typ.
- Sensing current range:  $\pm 10A$ ,  $\pm 20A$ , and  $\pm 30A$
- Output sensitivity: 66 to 185 mV/A
- Output voltage proportional to AC or DC currents
- Ratiometric output from supply voltage
- Single supply operation: 5.0V
- Low-noise analog signal path
- Device bandwidth is set via FILTER pin:  
80 kHz typ. Bandwidth with 1-nF filter capacitor
- Factory-trimmed for accuracy
- Extremely stable output offset voltage
- Near zero magnetic hysteresis
- Typical total output error of  $\pm 1.5\%$
- $>25$  kV/ $\mu s$  Common-Mode Transient Immunity
- Small footprint, low-profile SO-8 package
- Worldwide Safety Approval: UL, CSA:  
Isolation Voltage 3 kV<sub>RMS</sub>, 1 minute

#### Applications

- Low-power inverter current sensing
- Motor phase and rail current sensing
- Solar inverters
- Chargers and converters
- Switching power supplies

## Functional Diagram



**NOTE:** The connection of 1- $\mu$ F bypass capacitor between pins 8 and 5 is recommended.

## Pin Description

Pin	Pin Name	Description
1	I <sub>P+</sub>	Terminals for current being sampled; fused internally
2	I <sub>P+</sub>	
3	I <sub>P-</sub>	Terminals for current being sampled; fused internally
4	I <sub>P-</sub>	

Pin	Pin Name	Description
8	V <sub>DD</sub>	Supply voltage relative to GND
7	V <sub>OUT</sub>	Output Voltage
6	FILTER	Filter pin to set bandwidth
5	GND	Output side ground

## Typical Application Circuit

A typical application circuit for the ACHS-7121/7122/7123 product series consists of a bypass capacitor and a filter capacitor as additional external components. On the input side, pins 1 and 2 are shorted together and pins 3 and 4 shorted together. The output voltage is directly measured from the V<sub>OUT</sub> pin.



## Ordering Information

Part Number	Current Range	Option	Package	Surface Mount	Tape and Reel	UL 3 kV <sub>RMS</sub> 1 min. rating	Quantity
		(RoHS) Compliant					
ACHS-7121	±10A	-000E	SO-8	X		X	100 per tube
		-500E		X	X	X	1500 per reel
ACHS-7122	±20A	-000E		X		X	100 per tube
		-500E		X	X	X	1500 per reel
ACHS-7123	±30A	-000E		X		X	100 per tube
		-500E		X	X	X	1500 per reel

To order, choose a part number from the part number column and combine with the desired option from the option column to form an order entry.

**Example:**

Select ACHS-7122-500E to order product of ±20A, surface-mount package in tape and reel packaging and RoHS compliance. Contact your Broadcom sales representative or authorized distributor for information.

Option data sheets are available. Contact your Broadcom sales representative or authorized distributor for information.

# Package Outline Drawing

## ACHS-7121/7122/7123 SO-8 Package

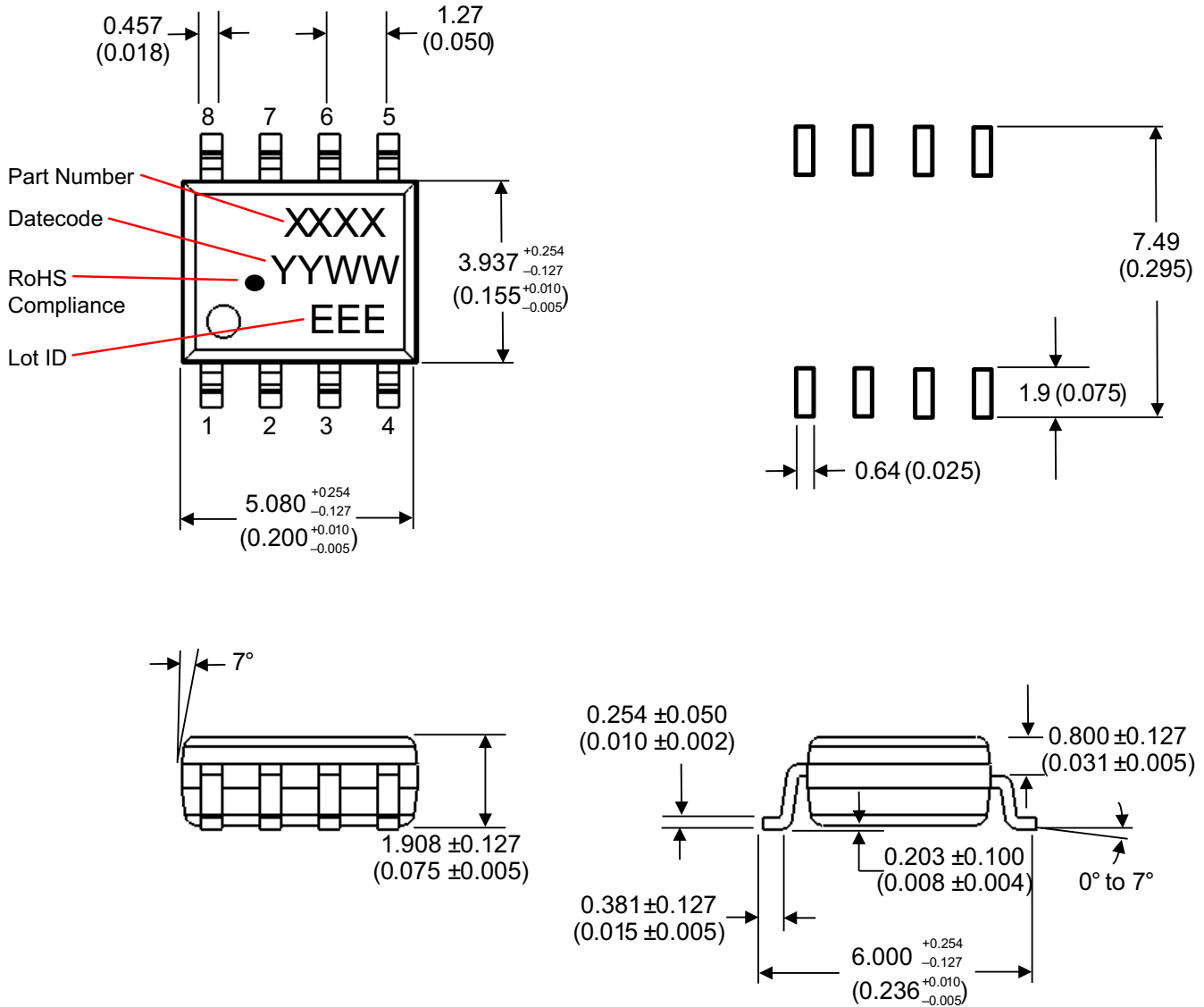

Dimensions in millimeters (inches).

**NOTE:**

- Lead coplanarity = 0.100 mm (0.004 in.) maximum.
- Floating lead protrusion = 0.254 mm (0.010 in.) maximum.
- Mold Flash on each side = 0.127 mm (0.005 in.) maximum.

### Recommended Pb-Free IR Profile

Recommended reflow condition as per JEDEC Standard, J-STD-020 (latest revision). Non-halide flux should be used.

## Regulatory Information

The ACHS-7121/7122/7123 is approved by the following organizations:

<b>UL/cUL</b>
UL 1577, component recognition program up to $V_{ISO} = 3000V_{RMS}$ . Approved under CSA Component Acceptance Notice #5.

## Insulation and Safety Related Specifications

Parameter	Symbol	Value	Units	Conditions
Minimum External Air Gap (External Clearance)	L(101)	4.0	mm	Measured from input terminals to output terminals, shortest distance through air.
Minimum External Tracking (External Creepage)	L(102)	4.0	mm	Measured from input terminals to output terminals, shortest distance path along body.
Minimum Internal Plastic Gap (Internal Clearance)	—	0.05	mm	Through insulation distance, conductor to conductor, usually the direct distance between the primary input conductor and detector IC.
Tracking Resistance (Comparative Tracking Index)	CTI	>175	V	DIN IEC 112/VDE 0303 Part 1.
Isolation Group	—	IIIa	—	Material Group (DIN VDE 0110, 1/89, Table 1).

## Absolute Maximum Rating

Parameter	Symbol	Min.	Max.	Units	Test Conditions
Storage Temperature	$T_S$	-55	125	°C	
Ambient Operating Temperature	$T_A$	-40	110	°C	
Junction Temperature	$T_J$	—	150	°C	
Primary Conductor Lead Temperature	$T_L$	—	150	°C	Pins 1, 2, 3, or 4
Supply Voltages	$V_{DD}$	-0.5	8.0	V	
Output Voltage	$V_{OUT}$	-0.5	$V_{DD} + 0.5$	V	
Output Current Source	$I_{OUT(source)}$	—	10	mA	$T_A = 25^\circ\text{C}$
Output Current Sink	$I_{OUT(sink)}$	—	10	mA	$T_A = 25^\circ\text{C}$
Overcurrent Transient Tolerance	$I_P$	—	100	A	1 pulse, 100 ms; $T_A = 25^\circ\text{C}$
Input Power Dissipation	$P_{IN}$	—	900	mW	$T_A = 25^\circ\text{C}$
Output Power Dissipation	$P_{OUT}$	—	90	mW	$T_A = 25^\circ\text{C}$

## Recommended Operating Conditions

Parameter	Symbol	Min.	Max.	Units	
Ambient Operating Temperature	$T_A$	-40	110	°C	
Supply Voltage	$V_{DD}$	4.5	5.5	V	
Output Capacitive Load	$C_{LOAD}$	—	10	nF	
Output Resistive Load	$R_{LOAD}$	4.7	—	kΩ	
Input Current Range	ACHS-7121	$I_P$	-10	10	A
	ACHS-7122		-20	20	A
	ACHS-7123		-30	30	A

## Common Electrical Specifications

Unless otherwise stated, all minimum/maximum specifications are over recommended operating conditions,  $C_F = 1$  nF. All typical values are based on  $T_A = 25^\circ\text{C}$ ,  $V_{DD} = 5.0\text{V}$ ,  $C_F = 1$  nF.

Parameter	Symbol	Min.	Typ.	Max.	Units	Test Condition	Figure	Note
Supply Current	$I_{DD}$	—	13	15	mA	$V_{DD} = 5\text{V}$ , output open	5, 6	a
Primary Conductor Resistance	$R_{PRIMARY}$	—	0.7	—	mΩ			a
Zero Current Output Voltage	$V_{OUT(Q)}$	—	$V_{DD}/2$	—	V	Bidirectional, $I_P = 0\text{A}$	2	a
Input Filter Resistance	$R_{F(INT)}$	—	1.6	—	kΩ			a
Bandwidth	BW	—	80	—	kHz	dB		a
Rise Time	$t_r$	—	4	—	μs		10	a
Power-on Time	$t_{PO}$	—	21	—	μs		8	a
Common Mode Transient Immunity	CMTI	25	—	—	kV/μs	$V_{CM} = 1000\text{V}$		b

a. See [Definition of Electrical Characteristics](#).

b. Common Mode Transient Immunity is tested by applying a fast rising/falling voltage pulse across pin 4 and GND (pin 5). The output glitch observed is less than 0.2V from the average output voltage for less than 1 μs.

# Electrical Specifications

## ACHS-7121

Unless otherwise stated, all minimum/maximum specifications are over recommended operating conditions,  $C_F = 1 \text{ nF}$ . All typical values are based on  $T_A = 25^\circ\text{C}$ ,  $V_{DD} = 5.0\text{V}$ ,  $C_F = 1 \text{ nF}$ .

Parameter	Symbol	Min.	Typ.	Max.	Units	Test Conditions	Figure	Note
Optimized Input Current Range	$I_P$	-10	—	10	A		7	a
Sensitivity	Sens	—	185	—	mV/A	$-10\text{A} \leq I_P \leq 10\text{A}$	1	b
Sensitivity Error	$E_{\text{SENS}}$	-3	—	3	%	$T_A = 25^\circ\text{C}$ , $V_{DD} = 5\text{V}$	1	b
Sensitivity Slope	$\Delta\text{Sens}$	—	-0.04	—	mV/A/ $^\circ\text{C}$	$T_A = -40^\circ\text{C}$ to $25^\circ\text{C}$	1	b
Sensitivity Slope	$\Delta\text{Sens}$	—	0.01	—	mV/A/ $^\circ\text{C}$	$T_A = 25^\circ\text{C}$ to $110^\circ\text{C}$	1	b
Zero Current Output Error	$V_{\text{OE}}$	-30	—	30	mV	$T_A = 25^\circ\text{C}$	2	b
Zero Current Output Error Slope	$\Delta V_{\text{OE}}$	—	-0.03	—	mV/ $^\circ\text{C}$	$T_A = -40^\circ\text{C}$ to $25^\circ\text{C}$	2	b
Zero Current Output Error Slope	$\Delta V_{\text{OE}}$	—	0.06	—	mV/ $^\circ\text{C}$	$T_A = 25^\circ\text{C}$ to $110^\circ\text{C}$	2	b
Output Noise	$V_{\text{N(RMS)}}$	—	7.8	—	mV	BW = 2 kHz	9	c
Nonlinearity	NL	—	0.27	—	%		3	d
Total Output Error	$E_{\text{TOT}}$	—	$\pm 1.5$	—	%		4	e
Sensitivity Error Lifetime Drift	$E_{\text{SENS\_DRIFT}}$	—	$\pm 2$	—	%			b
Total Output Error Lifetime Drift	$E_{\text{TOT\_DRIFT}}$	—	$\pm 2$	—	%			b

- The device may be operated at higher primary current levels,  $I_P$ , provided that the Maximum Junction Temperature,  $T_{J(\text{MAX})}$  is not exceeded.
- See [Definition of Electrical Characteristics](#).
- Output Noise is the noise level of the ACHS-7121/7122/7123 expressed in root mean square (RMS) voltage.
- Nonlinearity is defined as half of the peak-to-peak output deviation from the best-fit line, expressed as a percentage of the full-scale output voltage. See [Definition of Electrical Characteristics](#) for the complete definition and formula.
- Total output error in percentage is the difference between the measured output voltage at maximum input current ( $I_{P(\text{MAX})}$ ) and the ideal output voltage at  $I_{P(\text{MAX})}$  divided by the ideal output voltage at  $I_{P(\text{MAX})}$ . The Total Output Error typical value is based on total output error measured at the point of product release.

## ACHS-7122

Unless otherwise stated, all minimum/maximum specifications are over recommended operating conditions,  $C_F = 1 \text{ nF}$ . All typical values are based on  $T_A = 25^\circ\text{C}$ ,  $V_{DD} = 5.0\text{V}$ ,  $C_F = 1 \text{ nF}$ .

Parameter	Symbol	Min.	Typ.	Max.	Units	Test Conditions	Figure	Note
Optimized Input Current Range	$I_P$	-20	—	20	A		7	a
Sensitivity	Sens	—	100	—	mV/A	$-20\text{A} \leq I_P \leq 20\text{A}$	1	b
Sensitivity Error	$E_{\text{SENS}}$	-3	—	3	%	$T_A = 25^\circ\text{C}$ , $V_{DD} = 5\text{V}$	1	b
Sensitivity Slope	$\Delta\text{Sens}$	—	-0.01	—	mV/A/ $^\circ\text{C}$	$T_A = -40^\circ\text{C}$ to $25^\circ\text{C}$	1	b
Sensitivity Slope	$\Delta\text{Sens}$	—	0.01	—	mV/A/ $^\circ\text{C}$	$T_A = 25^\circ\text{C}$ to $110^\circ\text{C}$	1	b
Zero Current Output Error	$V_{\text{OE}}$	-25	—	25	mV	$T_A = 25^\circ\text{C}$	2	b
Zero Current Output Error Slope	$\Delta V_{\text{OE}}$	—	0.01	—	mV/ $^\circ\text{C}$	$T_A = -40^\circ\text{C}$ to $25^\circ\text{C}$	2	b
Zero Current Output Error Slope	$\Delta V_{\text{OE}}$	—	0.02	—	mV/ $^\circ\text{C}$	$T_A = 25^\circ\text{C}$ to $110^\circ\text{C}$	2	b
Output Noise	$V_{\text{N(RMS)}}$	—	4.1	—	mV	BW = 2 kHz	9	c
Nonlinearity	NL	—	0.18	—	%		3	d
Total Output Error	$E_{\text{TOT}}$	—	$\pm 1.5$	—	%		4	e
Sensitivity Error Lifetime Drift	$E_{\text{SENS\_DRIFT}}$	—	$\pm 2$	—	%			b
Total Output Error Lifetime Drift	$E_{\text{TOT\_DRIFT}}$	—	$\pm 2$	—	%			b

- The device may be operated at higher primary current levels,  $I_P$ , provided that the Maximum Junction Temperature,  $T_{J(\text{MAX})}$  is not exceeded.
- See [Definition of Electrical Characteristics](#).
- Output Noise is the noise level of the ACHS-7121/7122/7123 expressed in root mean square (RMS) voltage.
- Nonlinearity is defined as half of the peak-to-peak output deviation from the best-fit line, expressed as a percentage of the full-scale output voltage. See [Definition of Electrical Characteristics](#) for the complete definition and formula.
- Total output error in percentage is the difference between the measured output voltage at maximum input current ( $I_{P\text{MAX}}$ ) and the ideal output voltage at  $I_{P\text{MAX}}$  divided by the ideal output voltage at  $I_{P\text{MAX}}$ . The Total Output Error typical value is based on total output error measured at the point of product release.



## ACHS-7123

Unless otherwise stated, all minimum/maximum specifications are over recommended operating conditions,  $C_F = 1$  nF. All typical values are based on  $T_A = 25^\circ\text{C}$ ,  $V_{DD} = 5.0\text{V}$ ,  $C_F = 1$  nF.

Parameter	Symbol	Min.	Typ.	Max.	Units	Test Conditions	Figure	Note
Optimized Input Current Range	$I_P$	-30	—	30	A		7	a
Sensitivity	Sens	—	66	—	mV/A	$-30\text{A} \leq I_P \leq 30\text{A}$	1	b
Sensitivity Error	$E_{\text{SENS}}$	-3	—	3	%	$T_A = 25^\circ\text{C}$ , $V_{DD} = 5\text{V}$	1	b
Sensitivity Slope	$\Delta\text{Sens}$	—	-0.01	—	mV/A/ $^\circ\text{C}$	$T_A = -40^\circ\text{C}$ to $25^\circ\text{C}$	1	b
Sensitivity Slope	$\Delta\text{Sens}$	—	0.01	—	mV/A/ $^\circ\text{C}$	$T_A = 25^\circ\text{C}$ to $110^\circ\text{C}$	1	b
Zero Current Output Error	$V_{\text{OE}}$	-20	—	20	mV	$T_A = 25^\circ\text{C}$	2	b
Zero Current Output Error Slope	$\Delta V_{\text{OE}}$	—	0.01	—	mV/ $^\circ\text{C}$	$T_A = -40^\circ\text{C}$ to $25^\circ\text{C}$	2	b
Zero Current Output Error Slope	$\Delta V_{\text{OE}}$	—	0.02	—	mV/ $^\circ\text{C}$	$T_A = 25^\circ\text{C}$ to $110^\circ\text{C}$	2	b
Output Noise	$V_{\text{N(RMS)}}$	—	2.7	—	mV	BW = 2 kHz	9	c
Nonlinearity	NL	—	0.11	—	%		3	d
Total Output Error	$E_{\text{TOT}}$	—	$\pm 1.5$	—	%		4	e
Sensitivity Error Lifetime Drift	$E_{\text{SENS\_DRIFT}}$	—	$\pm 2$	—	%			b
Total Output Error Lifetime Drift	$E_{\text{TOT\_DRIFT}}$	—	$\pm 2$	—	%			b

- The device may be operated at higher primary current levels,  $I_P$ , provided that the Maximum Junction Temperature,  $T_{J(\text{MAX})}$  is not exceeded.
- See [Definition of Electrical Characteristics](#).
- Output Noise is the noise level of the ACHS-7121/7122/7123 expressed in root mean square (RMS) voltage.
- Nonlinearity is defined as half of the peak-to-peak output deviation from the best-fit line, expressed as a percentage of the full-scale output voltage. See [Definition of Electrical Characteristics](#) for the complete definition and formula.
- Total output error in percentage is the difference between the measured output voltage at maximum input current ( $I_{P\text{MAX}}$ ) and the ideal output voltage at  $I_{P\text{MAX}}$  divided by the ideal output voltage at  $I_{P\text{MAX}}$ . The Total Output Error typical value is based on total output error measured at the point of product release.

## Package Characteristics

Parameter	Symbol	Min.	Typ.	Max.	Units	Test Condition	Note
Input-Output Momentary Withstand Voltage	$V_{\text{ISO}}$	3000	—	—	$V_{\text{RMS}}$	RH < 50%, $t = 1$ min., $T_A = 25^\circ\text{C}$	a, b, c
Resistance (Input-Output)	$R_{\text{I-O}}$	—	$10^{14}$	—	$\Omega$	$V_{\text{I-O}} = 500\text{V}_{\text{DC}}$	c
Capacitance (Input-Output)	$C_{\text{I-O}}$	—	1.3	—	pF	$f = 1$ MHz	c
Junction-to-Ambient Thermal Resistance (due to Primary Conductor)	$R_{\theta 12}$	—	55	—	$^\circ\text{C/W}$	Based on the Broadcom evaluation board	d
Junction-to-Ambient Thermal Resistance (due to IC)	$R_{\theta 22}$	—	27	—	$^\circ\text{C/W}$	Based on the Broadcom evaluation board	d

- In accordance with UL 1577, each device is proof tested by applying an insulation test voltage  $\geq 3600 V_{\text{RMS}}$  for 1 second.
- Input-Output Momentary Withstand Voltage is a dielectric voltage rating that should not be interpreted as an input-output continuous voltage rating.
- This is a two-terminal measurement: pins 1 through 4 are shorted together and pins 5 through 8 are shorted together.
- The Broadcom evaluation board has  $300 \text{ mm}^2$  (total area including top and bottom copper) of 2 oz. copper connected to pins 1 and 2 and pins 3 and 4. Refer to the application section for additional information on thermal characterization.

# Typical Performance Plots

All typical plots are based on  $T_A = 25^\circ\text{C}$ ,  $V_{DD} = 5\text{V}$ ,  $C_F = 1\text{ nF}$ , unless otherwise stated.

**Figure 1: Sensitivity vs. Temperature**

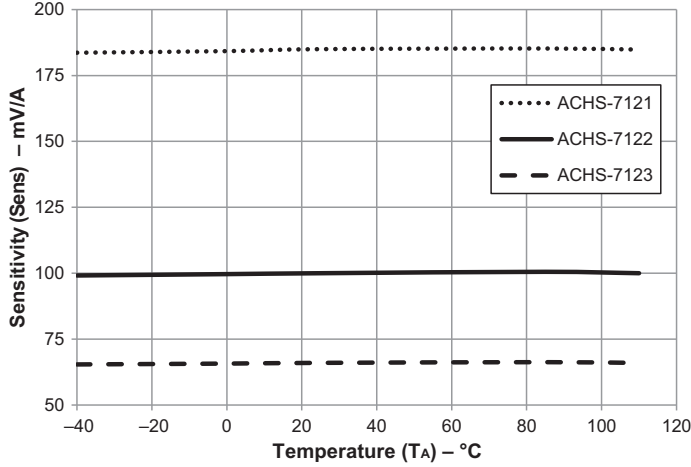

**Figure 2: Zero Current Output Voltage vs. Temperature**

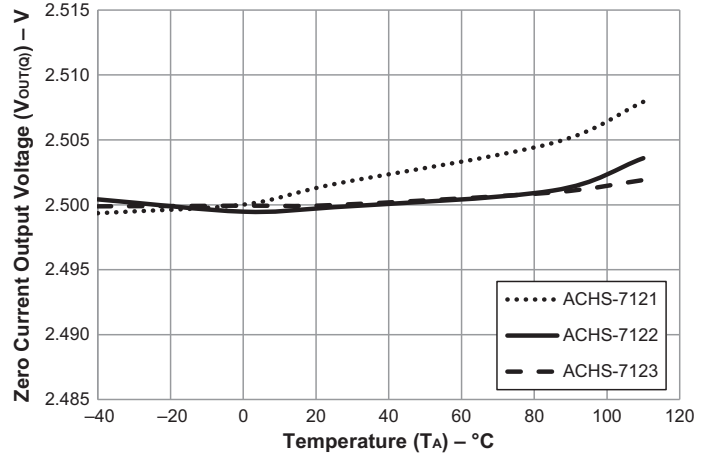

**Figure 3: Nonlinearity vs. Temperature**

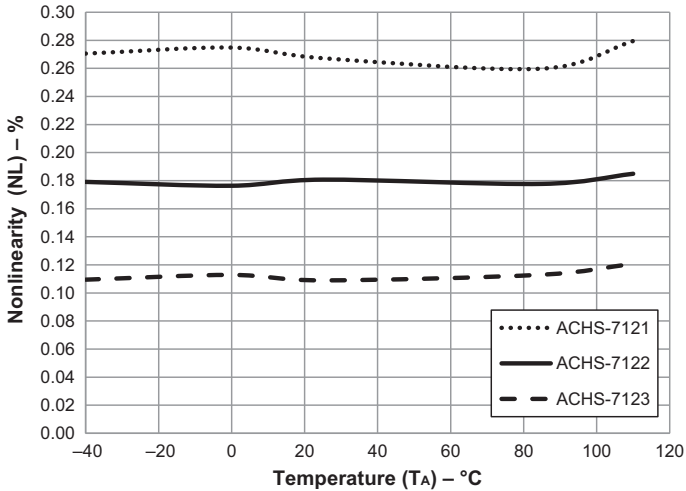

**Figure 4: Total Output Error at I<sub>PMAX</sub> vs. Temperature**

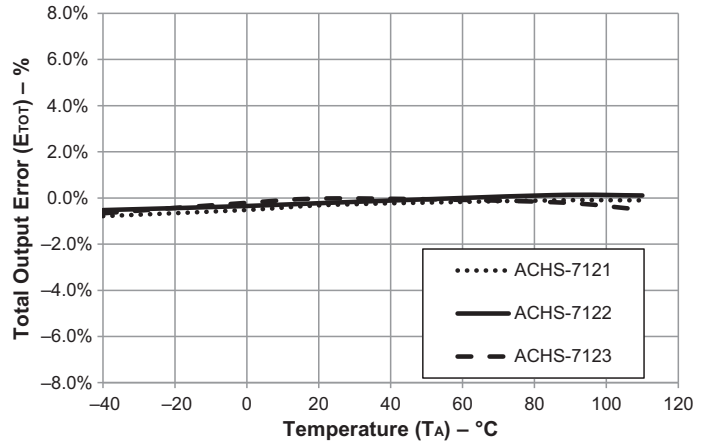

Figure 5: Supply Current vs. Temperature

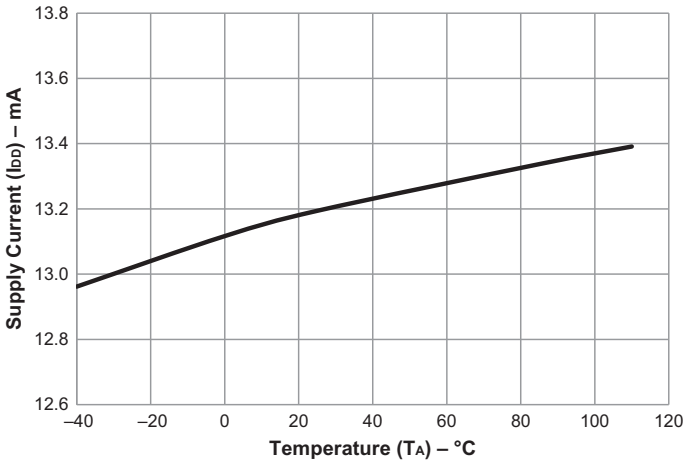

Figure 6: Supply Current vs. Supply Voltage

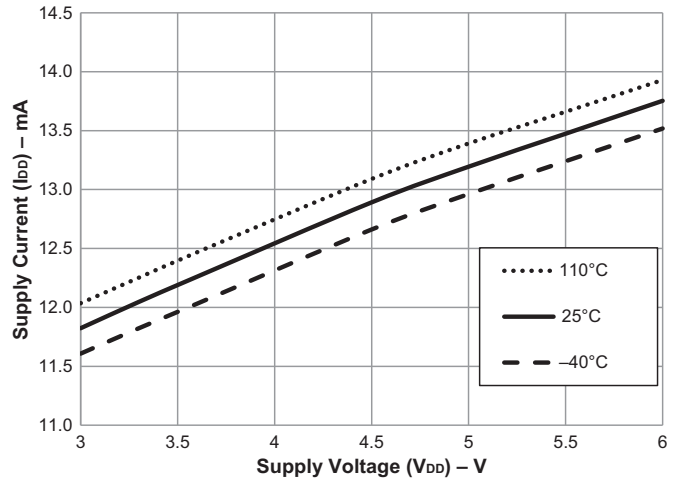

Figure 7: Output Voltage vs. Input Current

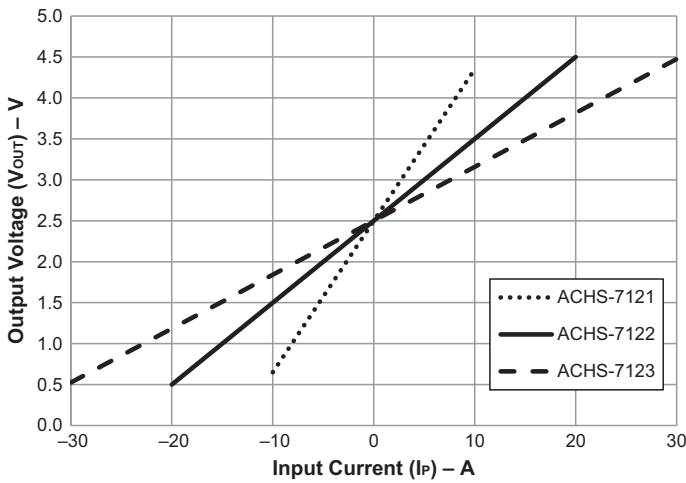

Figure 8: Power On Time vs. External Filter Capacitance

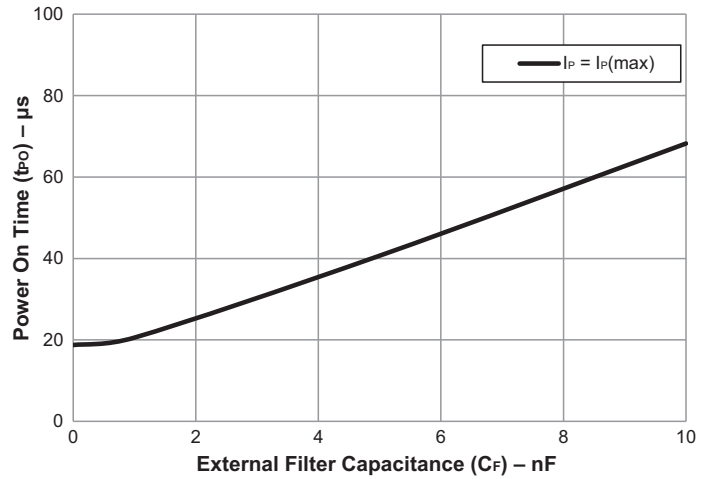

Figure 9: Output Noise vs. External Filter Capacitance

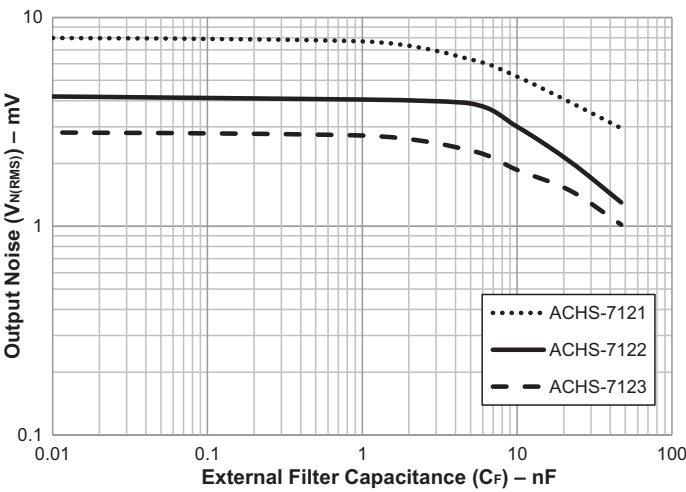
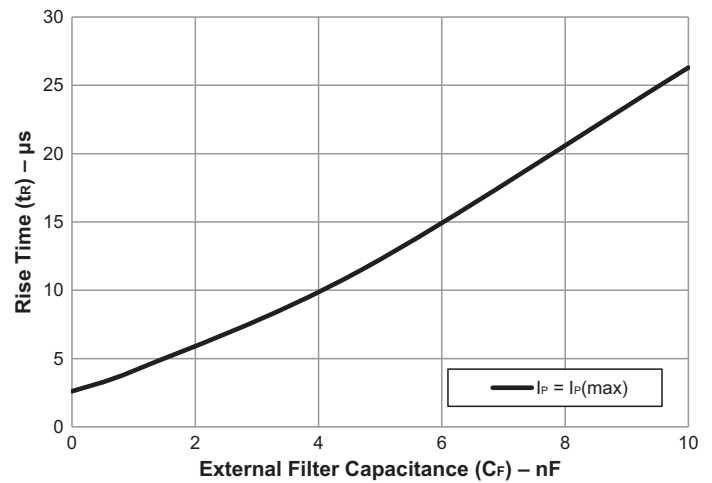

Figure 10: Rise Time vs. External Filter Capacitance



## Definition of Electrical Characteristics

The ACHS-7121/7122/7123 product series is a Hall Effect current sensor that outputs an analog voltage proportional to the magnetic field intensity caused by the current flowing through the input primary conductor. Without the magnetic field, the output voltage is half of the supply voltage. The sensor can detect both DC and AC current.

### Ratiometric Output

The output voltage of the ACHS-7121/7122/7123 series is ratiometric or proportional to the supply voltage. The sensitivity (Sens) of the device and the quiescent output voltage changes when there is a change in the supply voltage ( $V_{DD}$ ). For example, when the  $V_{DD}$  is increased by 10% from 5V to 5.5V in the ACHS-7122, the quiescent output voltage changes from 2.5V to 2.75V and the sensitivity also changes from 100 mV/A to 110 mV/A.

### Sensitivity

The output sensitivity (Sens) is the ratio of the output voltage ( $V_{OUT}$ ) over the input current ( $I_P$ ) flowing through the primary conductor. It is expressed in mV/A. When an applied current flows through the input primary conductor, it generates a magnetic field which the Hall IC converts into a voltage. The proportional voltage is provided by the Hall IC which is programmed in the factory for accuracy after packaging. The output voltage has a positive slope when an increasing current flows through pins 1 and 2 to pins 3 and 4. Sensitivity Error ( $E_{SENS}$ ) is the difference between the measured Sensitivity and the Ideal Sensitivity expressed as a percentage (%).

### Nonlinearity

Nonlinearity is defined as half of the peak-to-peak output deviation from the best-fit line (BFL), expressed as a percentage of the full-scale output voltage. The full-scale output voltage is the product of the sensitivity (Sens) and full scale input current ( $I_P$ ).

$$NL(\%) = \frac{[(Max\Delta \text{ from BFL} - Min\Delta \text{ from BFL}) / 2]}{Sens \times full \text{ scale } I_P} \times 100\%$$

Figure 11: Nonlinearity Calculation

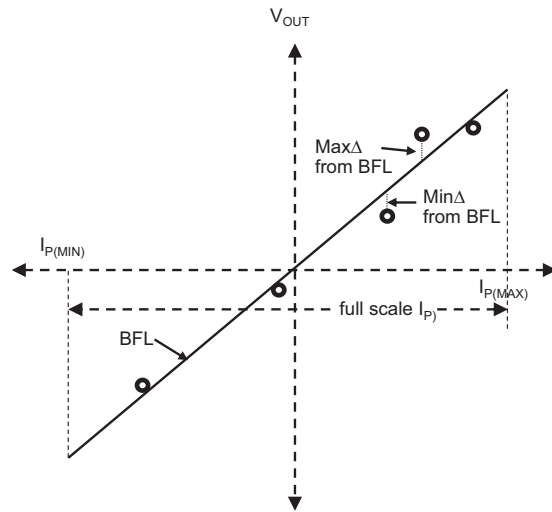

### Zero Current Output Voltage

This is the output voltage of ACHS-7121/7122/7123 when the primary current is zero. Zero current output voltage is half of the supply voltage ( $V_{DD}/2$ ).

### Zero Current Output Error

This is the voltage difference between the measured output voltage and the ideal output voltage ( $V_{DD}/2$ ) when there is no input current to the device.

### Total Output Error

Total output error in percentage is the difference between the measured output voltage at maximum input current ( $I_{PMAX}$ ) and the ideal output voltage at  $I_{PMAX}$  divided by the ideal output voltage at  $I_{PMAX}$ .

$$E_{TOT}(\%) = \frac{Measured V_{OUT} @ I_{PMAX} - Ideal V_{OUT} @ I_{PMAX}}{Ideal V_{OUT} @ I_{PMAX}} \times 100\%$$

### Power-On Time

This is the time required for the internal circuitry of the device to be ready during the ramping of the supply voltage. Power on time is defined as the finite time required for the output voltage to settle after the supply voltage reached its recommended operating voltage.

## FILTER Pin

The ACHS-7121/7122/7123 has a FILTER pin for improving the signal-to-noise ratio of the device. This eliminates the need for an external RC filter for the V<sub>OUT</sub> pin of the device, which can cause attenuation of the output signal. A ceramic capacitor, C<sub>F</sub>, can be connected between the FILTER pin to GND.

## Application Information

### PCB Layout

The design of the printed circuit board (PCB) should follow good layout practices, such as keeping bypass capacitors close to the supply pin and use of ground and power planes. A bypass capacitor must be connected between pins 5 and 8 of the device. The layout of the PCB can also affect the common-mode transient immunity of the device due to stray capacitive coupling between the input and output circuits. To obtain maximum common-mode transient immunity performance, the layout of the PCB should minimize any stray coupling by maintaining the maximum possible distance between the input and output sides of the circuit and ensuring that any ground or power plane on the PCB does not pass directly below or extend much wider than the body of the device.

### Land Pattern for 4 mm Board Creepage

For applications that require PCB creepage of 4 mm between input and output sides, the land pattern in [Figure 12](#) can be used.

**Figure 12: Land Pattern for 4 mm Creepage**

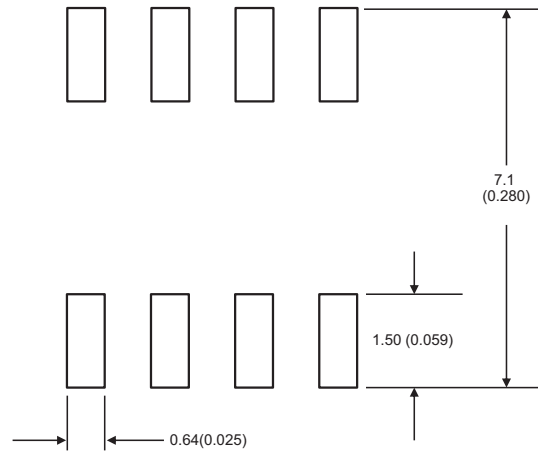

### Effect of PCB Layout on Sensitivity

The trace layout on the input pins of ACHS-7121/7122/7123 affects the sensitivity. It is recommended that the PCB trace connection to the input pins covers the pins fully, as shown in [Figure 13](#).

**Figure 13: Recommended Trace Layout on Input Pins**

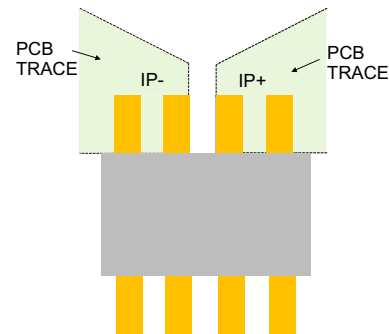

When the connection to the input pin only covers the vertical portion of the input pin, there is a sensitivity variation of about -0.6% versus recommended PCB trace layout (as shown in Figure 14).

**Figure 14: Vertical Portion Connection**

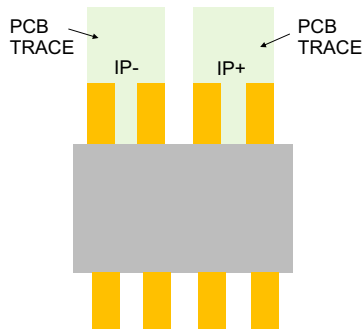

When the connection to the input pin only covers the horizontal portion of the input pin, there is a sensitivity variation of about +1.2% versus recommended PCB trace layout (as shown in Figure 15).

**Figure 15: Horizontal Portion Connection**

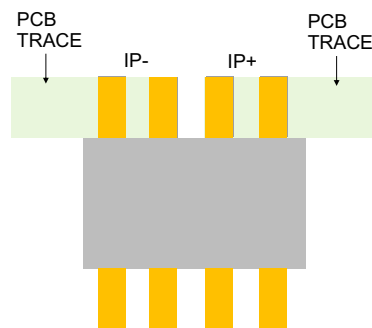

## Thermal Consideration

The evaluation board used in the thermal characterization is shown in Figure 16. Inputs IP+ and IP- are each connected to input plane of 2 oz. copper with 300 mm<sup>2</sup> total area (including top and bottom planes). The output side GND is connected to a ground plane of 2 oz. copper with 460 mm<sup>2</sup> total area (including top and bottom planes). The 2 oz. copper enables the board to conduct higher current and achieve good thermal distribution in a limited space.

**Figure 16: Broadcom Evaluation Board – Top Layer**

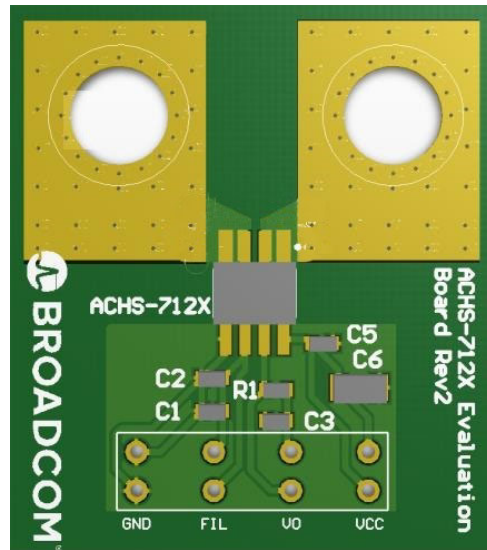

**Figure 17: Broadcom Evaluation Board – Bottom Layer**

