

## ACPDQC5V0ESPC-HF

### RoHS Device

### Halogen Free



### Features

- Bi-directional ESD protection.
- IEC 61000-4-2 ESD protection up to  $\pm 25\text{kV}$ (Contact).
- Surface mount package.
- Ultra small SMD package:0402C
- High component density.
- Low clamping voltage.
- Low leakage.
- Ultra-Low capacitance: 0.28 pF(typ.)
- Comply with AEC-Q101

### Mechanical data

- Case: 0402C/SOD-923F standard package, molded plastic.
- Terminals: Gold plated, solderable per MIL-STD-750, method 2026.
- Mounting position: Any.
- Weight: 0.001 grams(approx.).

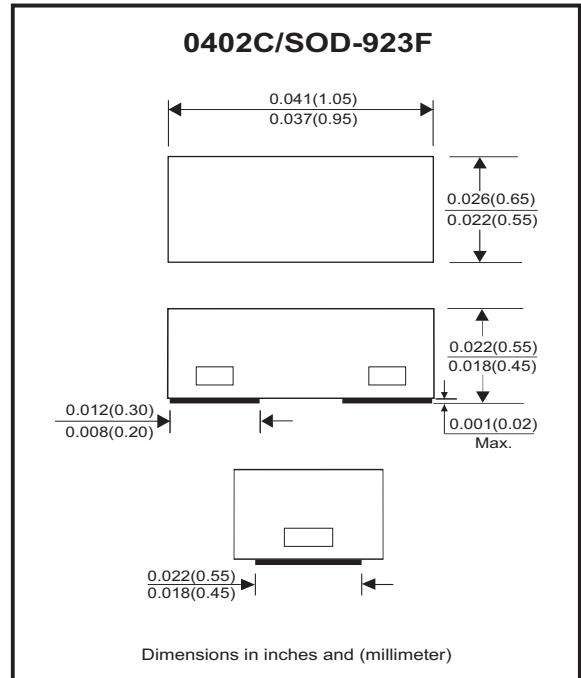

### Circuit diagram



### Maximum Rating (at $T_A=25^\circ\text{C}$ unless otherwise noted)

Parameter	Conditions	Symbol	Value	Unit
Peak pulse power	$T_P = 8/20\mu\text{s}$	$P_{PP}$	100	W
Peak pulse current	$T_P = 8/20\mu\text{s}$	$I_{PP}$	4	A
ESD capability	IEC 61000-4-2(air) IEC 61000-4-2(contact)	ESD	$\pm 25$	kV
Operation temperature range		$T_j$	-40~+125	$^\circ\text{C}$
Storage temperature range		$T_{STG}$	-55~+150	$^\circ\text{C}$

### Electrical Characteristics (at $T_A=25^\circ\text{C}$ unless otherwise noted)

Parameter	Conditions	Symbol	Min	Typ	Max	Unit
Working peak reverse voltage		$V_{RWM}$			5	V
Breakdown voltage	$I_T = 1\text{mA}$	$V_{BR}$	7	9		V
Reverse leakage current	$V_{RWM} = 5\text{V}$	$I_R$		<1	50	nA
Clamping voltage	$I_{PP} = 1\text{A}, T_P = 8/20\mu\text{s}$	$V_C$		13	15	V
	$I_{PP} = 4\text{A}, T_P = 8/20\mu\text{s}$			20	25	
Clamping voltage	$I_{PP} = 8\text{A}, T_P = 100\text{ns}$	$V_{CL}$		25		V
	$I_{PP} = 16\text{A}, T_P = 100\text{ns}$			35		
Dynamic resistance		$R_{DYN}$		1.3		$\Omega$
Junction capacitance	$V_R = 0\text{V}, f = 1\text{MHz}$	$C_J$		0.28	0.35	pF

## RATING AND CHARACTERISTIC CURVES (ACPDQC5V0ESPC-HF)

Fig.1 - 8/20us Peak Pulse Current Waveform Acc. IEC 61000-4-5

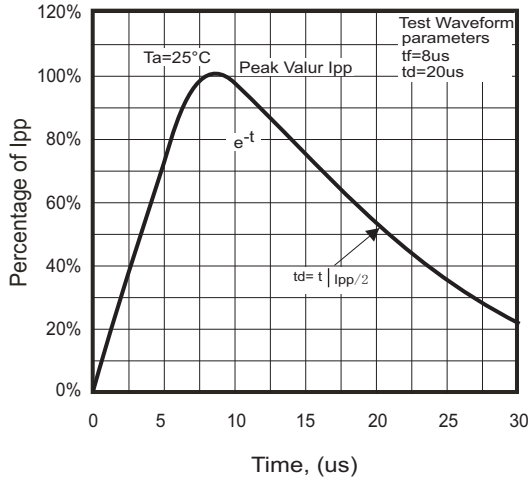

Fig.2 - Power Rating Derating Curve

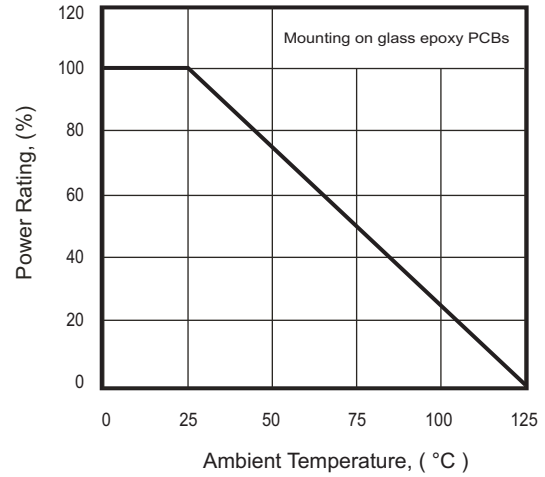

Fig.3 - Capacitance Between Terminals Characteristics

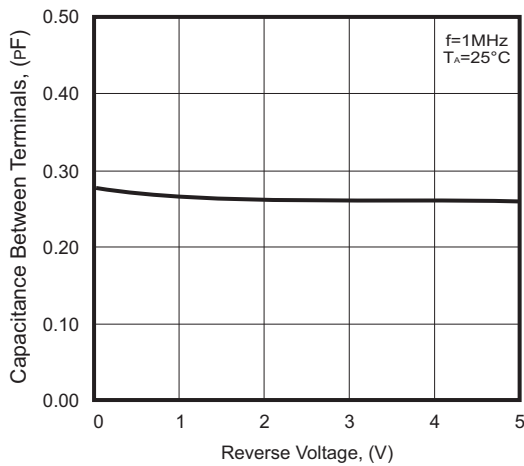

Fig.4 - Clamping Voltage Vs. Peak Pulse Current

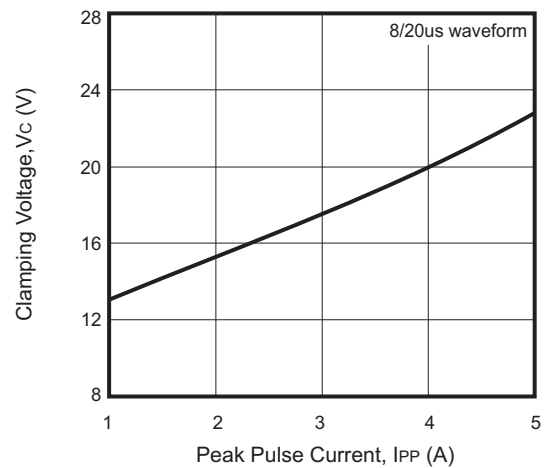

Fig.5 - Insertion Loss, Typical Values

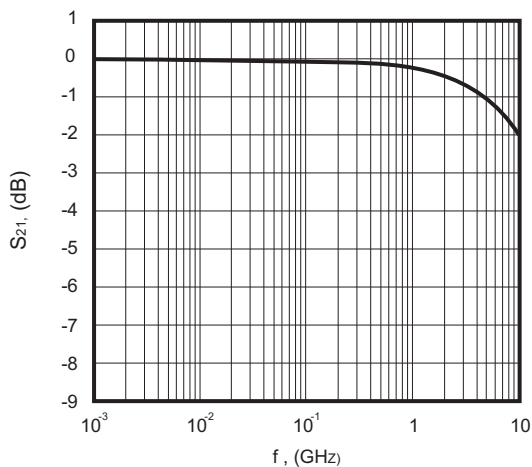
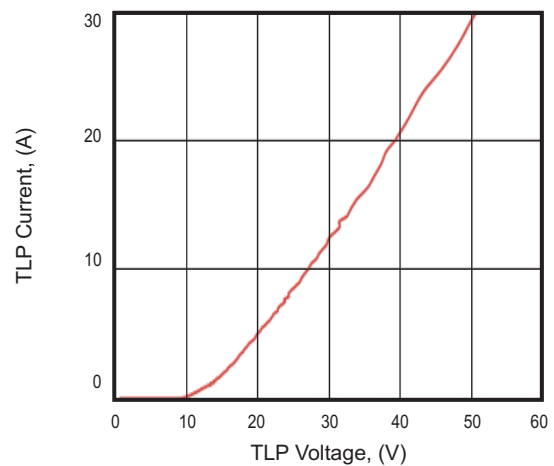
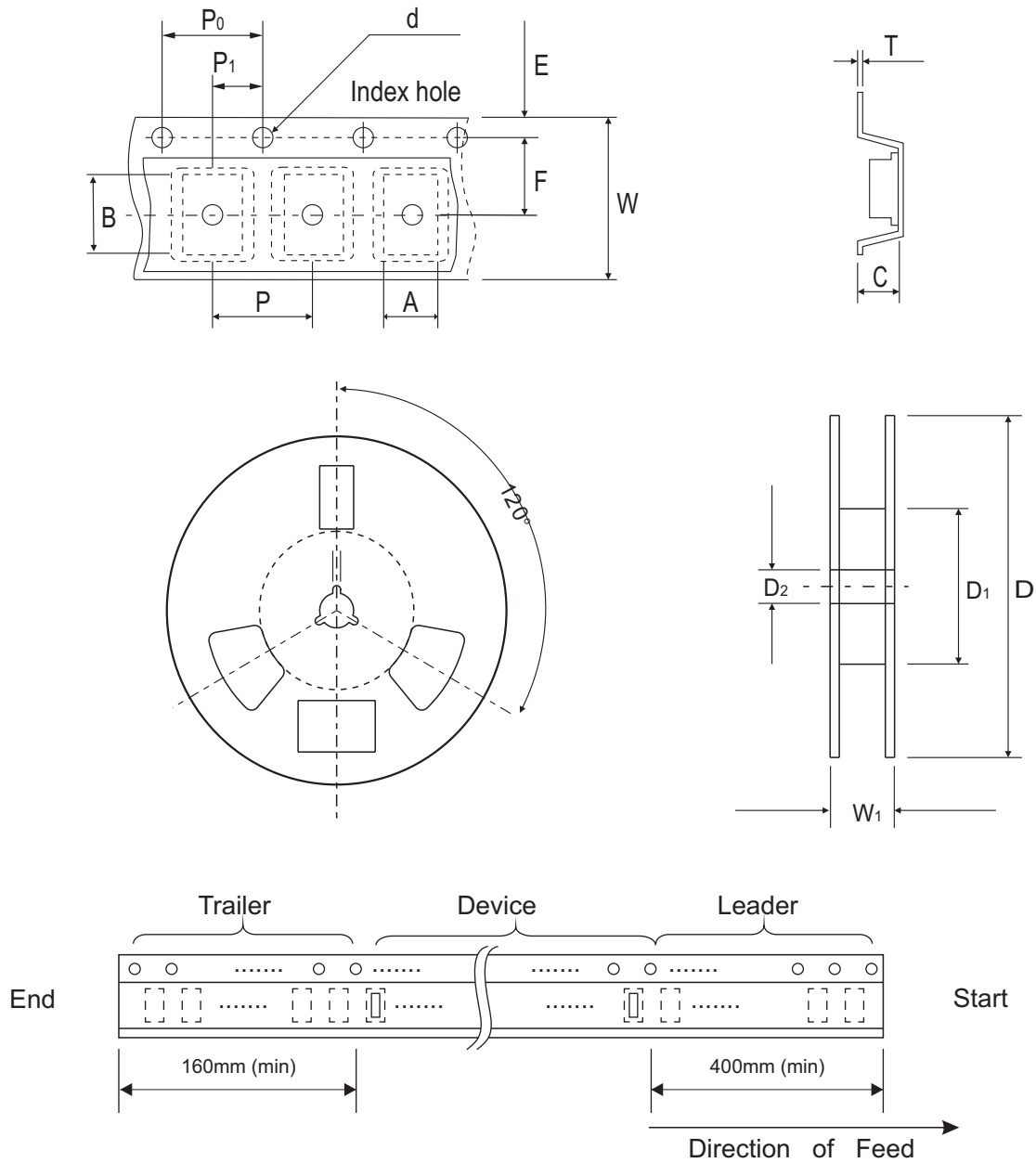

Fig.6 - Positive TLP IV Curve



## Reel Taping Specification



0402C (SOD-923F)	SYMBOL	A	B	C	d	D	D <sub>1</sub>	D <sub>2</sub>
	(mm)	0.75 ± 0.05	1.17 ± 0.05	0.65 ± 0.05	1.50 + 0.10 - 0	178.00 ± 1.00	60.00 ± 0.50	13.50 ± 0.20
	(inch)	0.030 ± 0.002	0.046 ± 0.002	0.026 ± 0.002	0.059 + 0.004 - 0	7.008 ± 0.039	2.362 ± 0.020	0.531 ± 0.008

0402C (SOD-923F)	SYMBOL	E	F	P	P <sub>0</sub>	P <sub>1</sub>	T	W	W <sub>1</sub>
	(mm)	1.75 ± 0.10	3.50 ± 0.10	4.00 ± 0.10	4.00 ± 0.10	2.00 ± 0.10	0.20 + 0.02 - 0.05	8.00 ± 0.20	12.00 + 0.50 - 0
	(inch)	0.069 ± 0.004	0.138 ± 0.004	0.157 ± 0.004	0.157 ± 0.004	0.079 ± 0.004	0.008 + 0.001 - 0.002	0.315 ± 0.008	0.472 + 0.020 - 0

Company reserves the right to improve product design, functions and reliability without notice.

REV:A