

## ACPDUC5V0USP-HF

### RoHS Device

### Halogen Free



### Features

- Uni-directional ESD protection.
- Surface mount package.
- Low capacitance.
- Low Leakage current.
- High component density.
- Comply with AEC-Q101

### Mechanical data

- Case: 0603C/SOD-523F standard package, molded plastic.
- Terminals: Matte tin plated, Solderable per MIL-STD-750, Method 2026.
- Marking Code: Cathode band & E5P
- Mounting position: Any.
- Weight: 0.003 grams(approx.).

### Circuit diagram

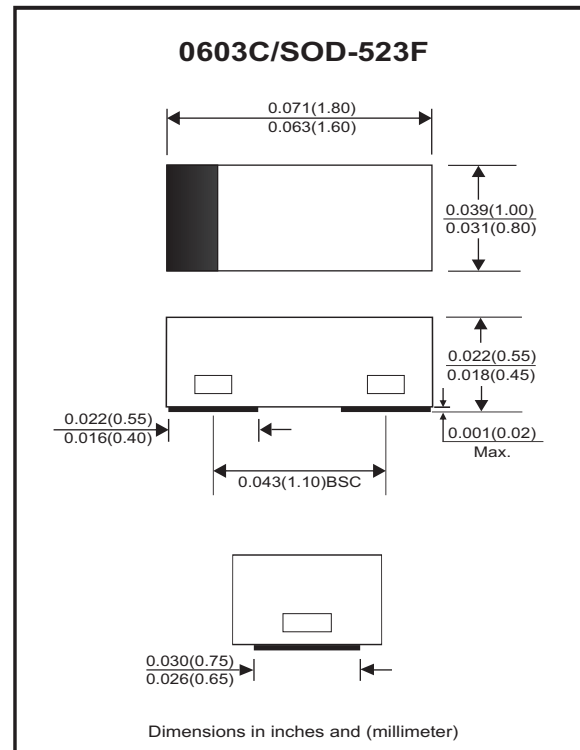

### Maximum Rating (at TA=25°C unless otherwise noted)

Parameter	Conditions	Symbol	Value	Unit
Peak pulse power	$T_P = 8/20\mu s$	$P_{PP}$	60	W
Peak pulse current	$T_P = 8/20\mu s$	$I_{PP}$	3	A
ESD capability	IEC 61000-4-2(air) IEC 61000-4-2(contact)	ESD	$\pm 15$ $\pm 8$	kV
Operation temperature range		$T_j$	-55~+150	°C
Storage temperature range		$T_{STG}$	-55~+150	°C

### Electrical Characteristics (at TA=25°C unless otherwise noted)

Parameter	Conditions	Symbol	Min	Typ	Max	Unit
Working peak reverse voltage		$V_{RWM}$			5	V
Forward voltage	$I_F = 10mA$	$V_F$			1.5	V
Diode breakdown voltage	$I_T = 1mA$	$V_{BR}$	5.4			V
Reverse current	$V_{RWM} = 5V$	$I_R$		0.1	1.0	$\mu A$
Clamping voltage	$I_{PP} = 1A, T_P = 8/20\mu s$ $I_{PP} = 3A, T_P = 8/20\mu s$	$V_C$			13 20	V
Junction capacitance	$V_R = 0V, f = 1MHz$	$C_J$		0.6	0.9	pF

Company reserves the right to improve product design , functions and reliability without notice.

REV:A

## RATING AND CHARACTERISTIC CURVES (ACPDUC5V0USP-HF)

Fig.1 - 8/20us Peak Pulse Current Waveform Acc. IEC 61000-4-5

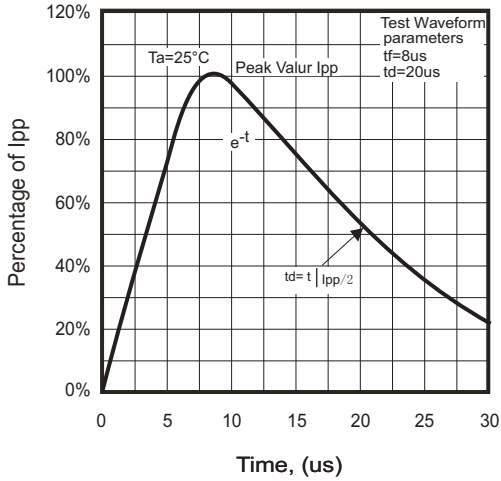

Fig.2 - Power Rating Derating Curve

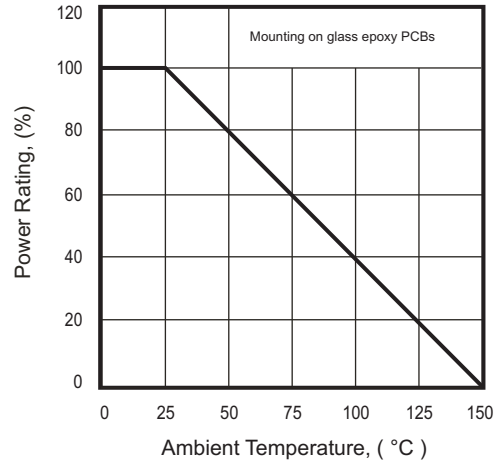

Fig.3 - Clamping Voltage Vs. Peak Pulse Current

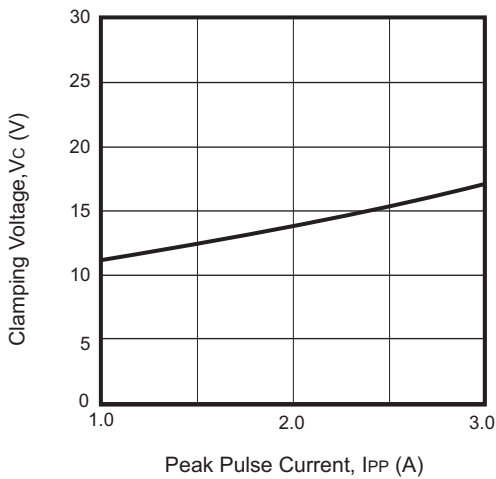

Fig.4 - Forward Voltage Vs. Forward Current

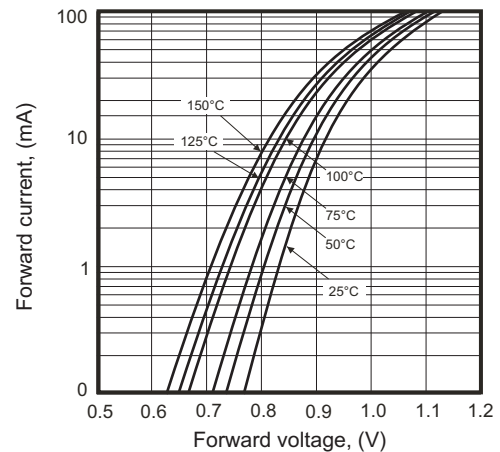
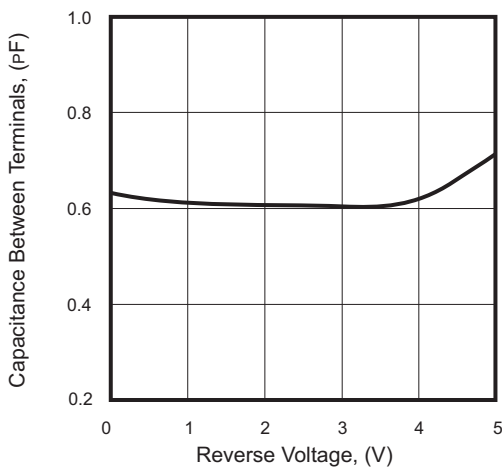
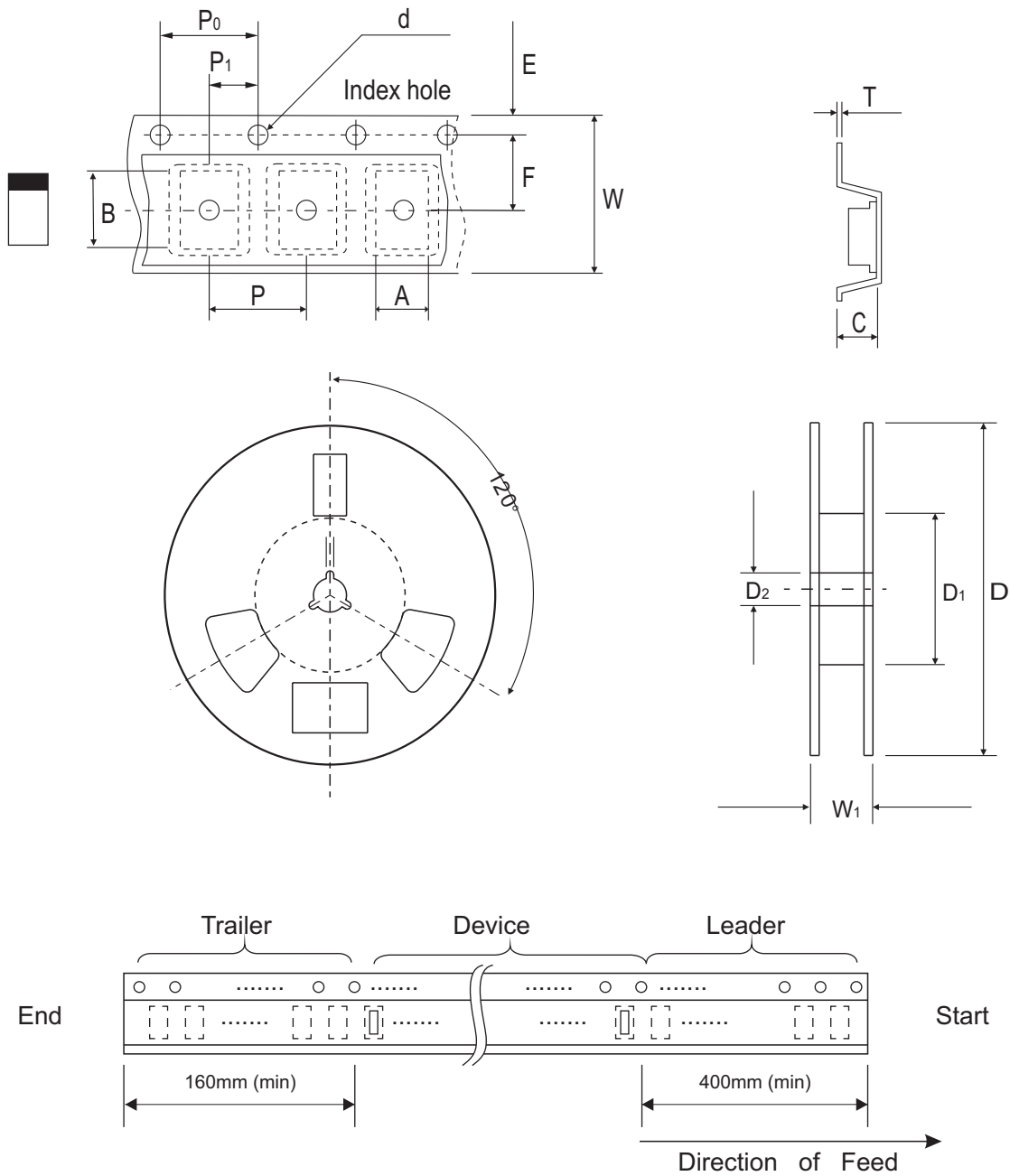

Fig.5 - Capacitance Between Terminals Characteristics



## Reel Taping Specification



0603C/ SOD-523F	SYMBOL	A	B	C	d	D	D <sub>1</sub>	D <sub>2</sub>
	(mm)	1.05 ± 0.05	1.96 ± 0.05	0.57 ± 0.05	1.50 + 0.10 - 0	178.00 ± 1.00	60.00 ± 0.50	13.50 ± 0.20
	(inch)	0.041 ± 0.002	0.077 ± 0.002	0.022 ± 0.002	0.059 + 0.004 - 0	7.008 ± 0.039	2.362 ± 0.020	0.531 ± 0.008

0603C/ SOD-523F	SYMBOL	E	F	P	P <sub>0</sub>	P <sub>1</sub>	T	W	W <sub>1</sub>
	(mm)	1.75 ± 0.10	3.50 ± 0.05	4.00 ± 0.10	4.00 ± 0.05	2.00 ± 0.05	0.20 ± 0.03	8.00 ± 0.20	12.00 + 0.50 - 0
	(inch)	0.069 ± 0.004	0.138 ± 0.002	0.157 ± 0.004	0.157 ± 0.002	0.079 ± 0.002	0.008 ± 0.001	0.315 ± 0.008	0.472 + 0.020 - 0