

## ACPL-8x7

### Multi-Channel Full-Pitch Phototransistor Optocoupler

---

#### Description

The ACPL-827 is a DC-input dual-channel, full-pitch phototransistor optocoupler that contains two light emitting diodes optically coupled to two separate transistors. It is packaged in an 8-pin DIP package.

Likewise, the ACPL-847 is a DC-input quad-channel, full-pitch phototransistor optocoupler that contains four light emitting diodes optically coupled to four separate transistors. It is packaged in a 16-pin DIP package.

Both optocouplers are available in a wide-lead spacing option and a lead bend SMD option with an input-output isolation voltage of 5000  $V_{rms}$ . Response time,  $t_r$ , is typically 4  $\mu s$  and minimum CTR is 50% at input current of 5 mA.

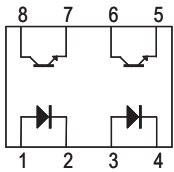
#### Features

- Current transfer ratio (CTR: min. 50% at  $I_F = 5$  mA,  $V_{CE} = 5$  V)
- High input-output isolation voltage ( $V_{ISO} = 5,000$   $V_{rms}$ )
- Response time ( $t_r$ : typ. 4  $\mu s$  at  $V_{CE} = 2$  V,  $I_C = 2$  mA,  $R_L = 100\Omega$ )
- Compact dual-in-line package
- Safety and regulatory approvals
  - CSA
  - UL 1577
  - IEC/EN/DIN EN 60747-5-2
- Options available:
  - Leads with 0.4 in. (10.16 mm) spacing (W00)
  - Lead bend for surface mounting (300)
  - Tape and reel for SMD (500) – available only for ACPL-827
  - IEC/EN/DIN EN 60747-5-2 approved (060)
  - Lead free (000E)

#### Applications

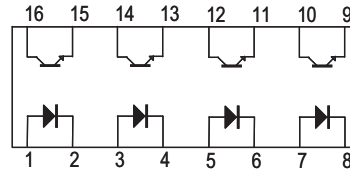
- I/O interface for programmable controllers, computers.
- Sequence controllers.
- System appliances, measuring instruments.
- Signal transmission between circuits of different potentials and impedances.

## ACPL-827 Pin Layout



Pin 1, 3	Anode
Pin 2, 4	Cathode
Pin 5, 7	Emitter
Pin 6, 8	Collector

## ACPL-847 Pin Layout



Pin 1, 3, 5, 7	Anode
Pin 2, 4, 6, 8	Cathode
Pin 9, 11, 13, 15	Emitter
Pin 10, 12, 14, 16	Collector

## Ordering Information

ACPL-8x7 is UL Recognized with 5000  $V_{rms}$  for 1 minute per UL1577 and is approved under CSA Component Acceptance Notice #5, File CA 88324.

Part Number	RoHS Compliant Option				Package	No. of Channels	Surface Mount	Gull Wing	Tape & Reel	IEC/EN/DIN EN 60747-5-2	Quantity
	Rank 0 50% <CTR> 600%	Rank B 130% <CTR> 260%	Rank C 200% <CTR> 400%	Rank G 130% <CTR> 400%							
ACPL-827	-000E	-00BE	-00CE		300-mil DIP-8	Dual					50 pcs per tube
	-300E	-30BE	-30CE		300-mil DIP-8		x	X			50 pcs per tube
	-500E	-50BE	-50CE		300-mil DIP-8		X	X	X		1000 pcs per reel
	-060E	-06BE	-06CE		300-mil DIP-8					X	50 pcs per tube
	-360E	-36BE	-36CE		300-mil DIP-8		x	X		X	50 pcs per tube
	-560E	-56BE	-56CE		300-mil DIP-8		x	X	X	X	1000 pcs per reel
	-W00E	-W0BE	-W0CE		400-mil DIP-8						50 pcs per tube
	-W60E	-W6BE	-W6CE		400-mil DIP-8					X	50 pcs per tube
ACPL-847	-000E			-00GE	300-mil DIP-16	Quad					25 pcs per tube
	-300E			-30GE	300-mil DIP-16		X	X			25 pcs per tube
	-060E			-06GE	300-mil DIP-16					X	25 pcs per tube
	-360E			-36GE	300-mil DIP-16		X	X		X	25 pcs per tube
	-W00E			-W0GE	400-mil DIP-16						25 pcs per tube
	-W60E			-W6GE	400-mil DIP-16					X	25 pcs per tube

To order, choose a part number from the part number column and combine with the desired option from the option column to form an order entry.

### Example 1:

ACPL-827-36GE to order product of 300-mil DIP-8 Dual Channel DC Gull Wing Surface Mount package in Tube packaging with 130%<CTR>400%, IEC/EN/DIN EN 60747-5-2 Safety Approval and RoHS compliant.

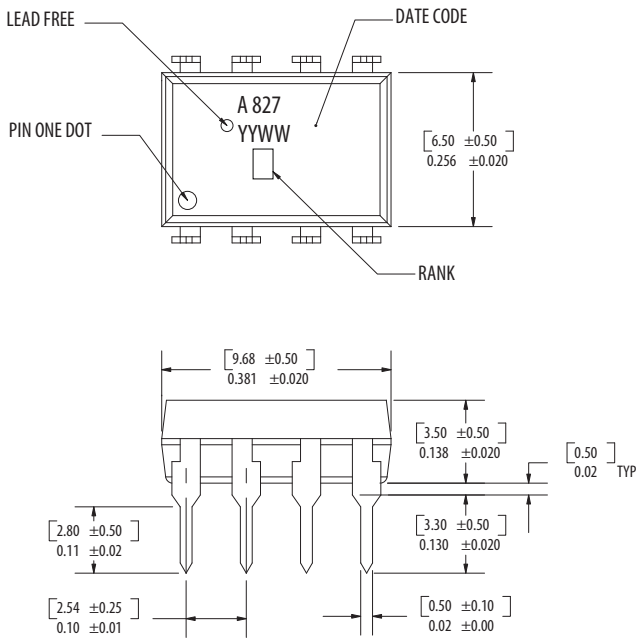
### Example 2:

ACPL-847-W00E to order product of 400-mil DIP-16 Quad Channel DC package in Tube packaging with 50%<CTR>600% and RoHS compliant.

Option data sheets are available. Contact your Broadcom sales representative or authorized distributor for information.

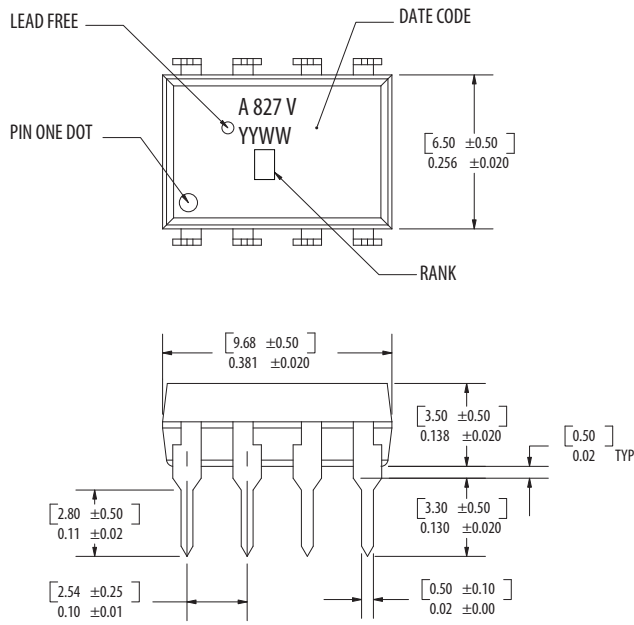
# Package Outline Drawings

## ACPL-827 Package Outline



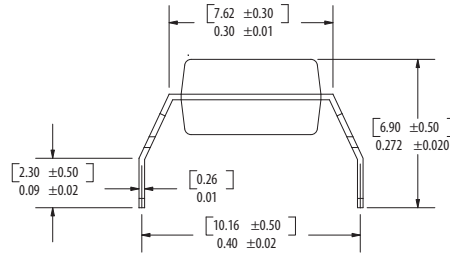
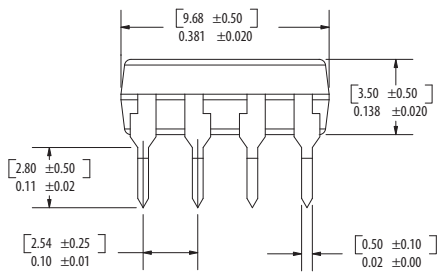
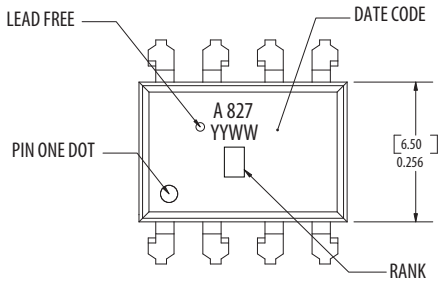
Note: Dimensions are in [millimeters] and inches.

## ACPL-827 Package Outline – Option 060



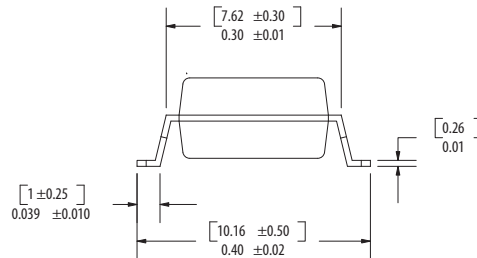
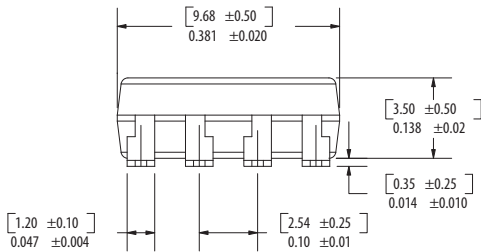
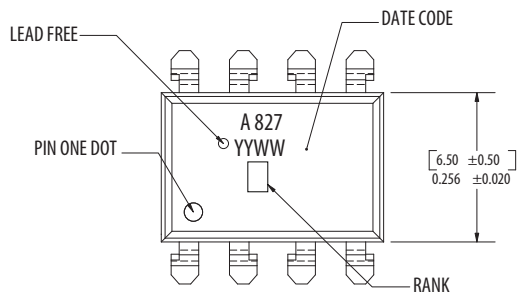
Note: Dimensions are in [millimeters] and inches.

## ACPL-827 Package Outline – Option W00



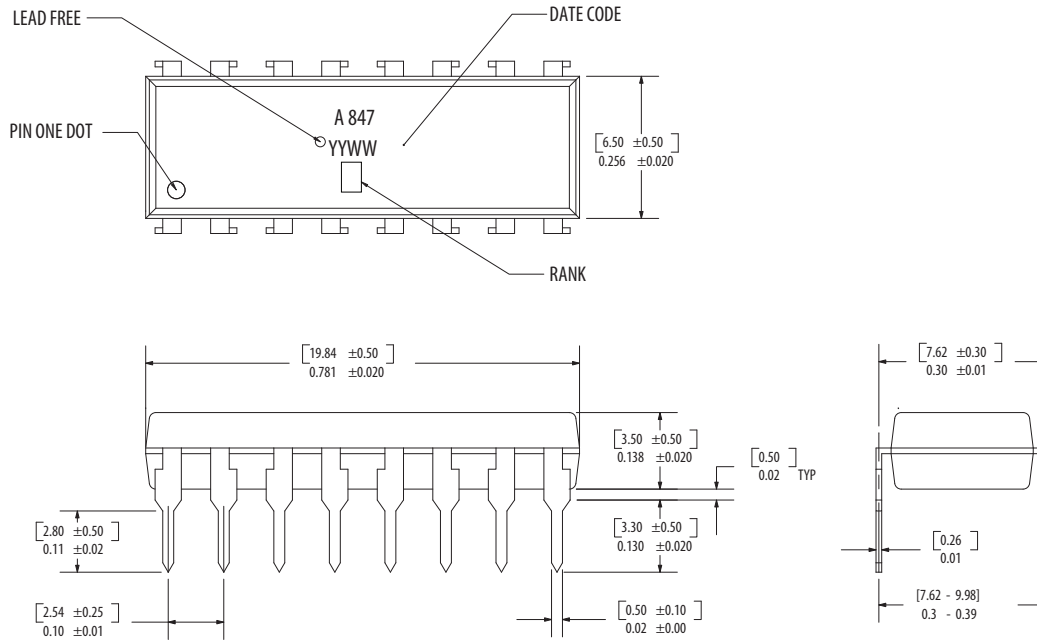
Note: Dimensions are in [millimeters] and inches.

## ACPL-827 Package Outline – Option 300



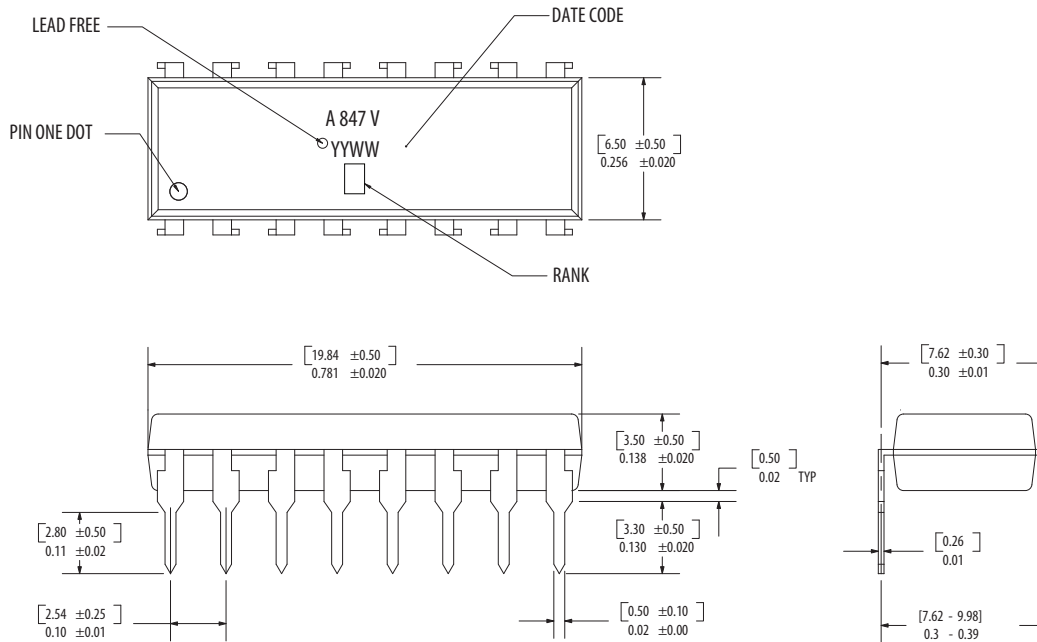
Note: Dimensions are in [millimeters] and inches.

## ACPL-847 Package Outline



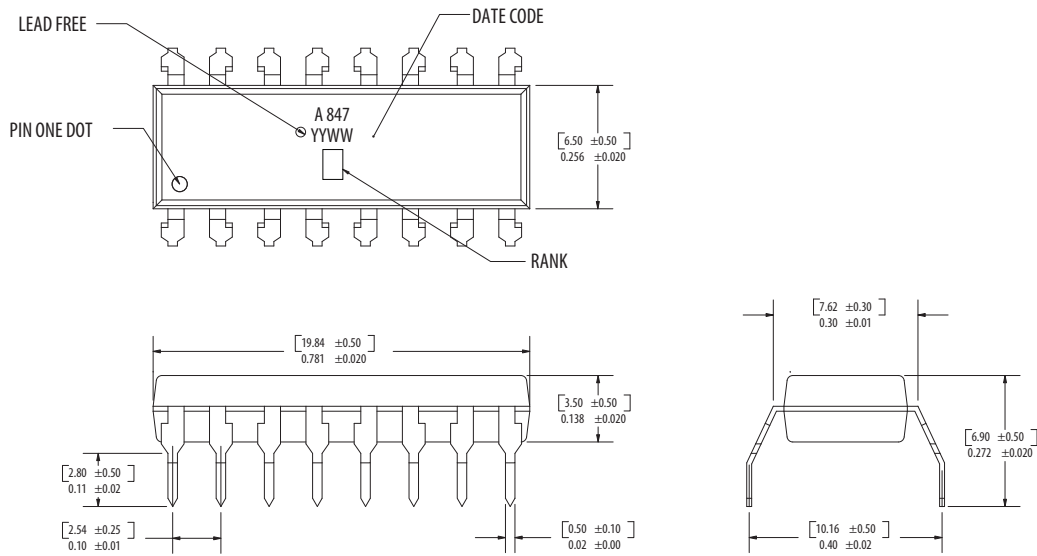
Note: Dimensions are in [millimeters] and inches.

## ACPL-847 Package Outline - Option 060



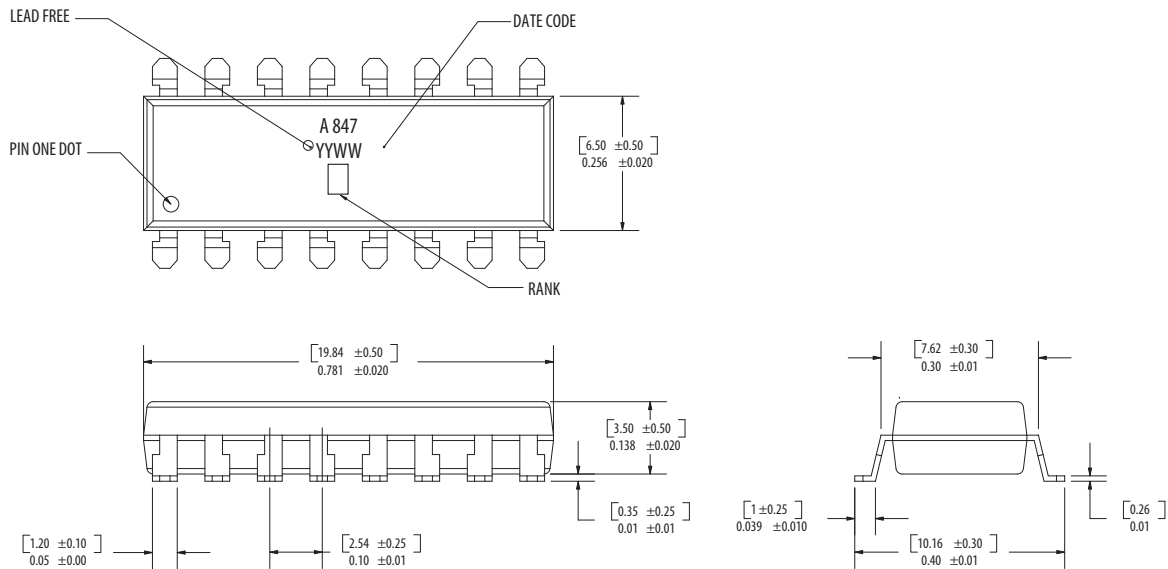
Note: Dimensions are in [millimeters] and inches.

## ACPL-847 Package Outline - Option W00



Note: Dimensions are in [millimeters] and inches.

## ACPL-847 Package Outline - Option 300

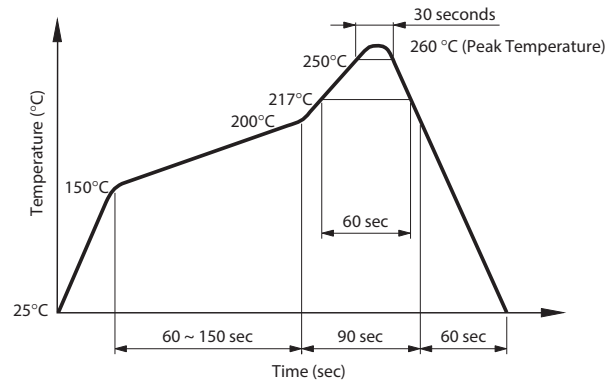


Note: Dimensions are in [millimeters] and inches.

## Solder Reflow Temperature Profile

1. One-time soldering reflow is recommended within the condition of temperature and time profile shown at right.
2. When using another soldering method such as infrared ray lamp, the temperature might rise partially in the mold of the device. Keep the temperature on the package of the device within the condition of (1) above.

**NOTE:** Non-halide flux should be used.



## Absolute Maximum Ratings

Parameter	Symbol	Min.	Max.	Units	Note
Storage Temperature	$T_S$	-55	125	°C	
Operating Temperature	$T_A$	-30	100	°C	
Average Forward Current	$I_{F(AVG)}$	—	50	mA	
Input Power Dissipation	$P_I$	—	70	mW	
Input Reverse Voltage	$V_R$	—	6	V	
Collector Current	$I_C$	—	50	mA	
Collector-Emitter Voltage	$V_{CEO}$	—	70	V	
Emitter-Collector Voltage	$V_{ECO}$	—	6	V	
Isolation Voltage (AC for 1 min, R.H. 40% ~ 60%)	$V_{ISO}$	—	5000	$V_{rms}$	
Collector Power Dissipation	$P_C$	—	150	mW	
Total Power Dissipation	$P_{TOT}$	—	200	mW	
Lead Solder Temperature		260°C for 10 sec., 1.6 mm below seating plane			

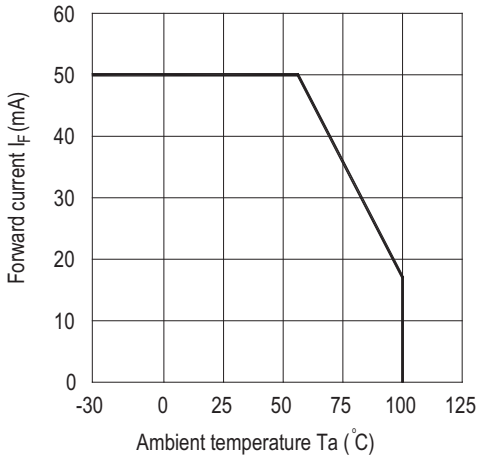
## Electrical Specifications (DC)

Over recommended operating conditions unless otherwise specified.

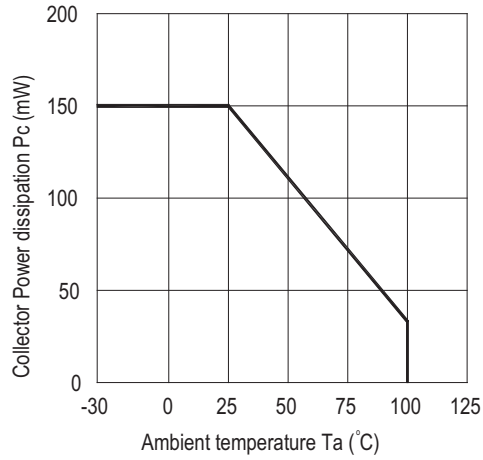
Parameter	Symbol	Min.	Typ.	Max.	Units	Test Conditions	Note
Forward Voltage	$V_F$	—	1.2	1.4	V	$I_F = 20 \text{ mA}$	
Reverse Current	$I_R$	—	—	10	$\mu\text{A}$	$V_R = 4\text{V}$	
Terminal Capacitance	$C_t$	—	30	250	pF	$V = 0, f = 1 \text{ kHz}$	
Collector Dark Current	$I_{CEO}$	—	—	100	nA	$V_{CE} = 20\text{V}, I_F = 0 \text{ mA}$	
Collector-Emitter Breakdown Voltage	$BV_{CEO}$	70	—	—	V	$I_C = 0.1 \text{ mA}, I_F = 0 \text{ mA}$	
Emitter-Collector Breakdown Voltage	$BV_{ECO}$	6	—	—	V	$I_E = 10 \mu\text{A}, I_F = 0 \text{ mA}$	
Collector Current	$I_C$	2.5	—	30	mA	$I_F = 5 \text{ mA}, V_{CE} = 5\text{V}$	$CTR = (I_C/I_F) \times 100\%$
Current Transfer Ratio	CTR	50	—	600	%		
Collector-Emitter Saturation Voltage	$V_{CE(sat)}$	—	0.1	0.2	V	$I_F = 20 \text{ mA}, I_C = 1 \text{ mA}$	
Isolation Resistance	$R_{ISO}$	$5 \times 10^{10}$	$1 \times 10^{11}$	—	$\Omega$	DC500V, R.H. 40% ~ 60%	
Floating Capacitance	$C_F$	—	0.6	1	pF	$V = 0, f = 1 \text{ MHz}$	
Cut-off Frequency (-3 dB)	$F_C$	—	80	—	kHz	$V_{CE} = 5\text{V}, I_C = 2 \text{ mA}, RL = 100\Omega$	See <a href="#">Figure 12</a> .
Response Time (Rise)	$t_r$	—	4	18	$\mu\text{s}$	$V_{CE} = 2\text{V}, I_C = 2 \text{ mA}, RL = 100\Omega$	See <a href="#">Figure 12</a> .
Response Time (Fall)	$t_f$	—	3	18	$\mu\text{s}$		



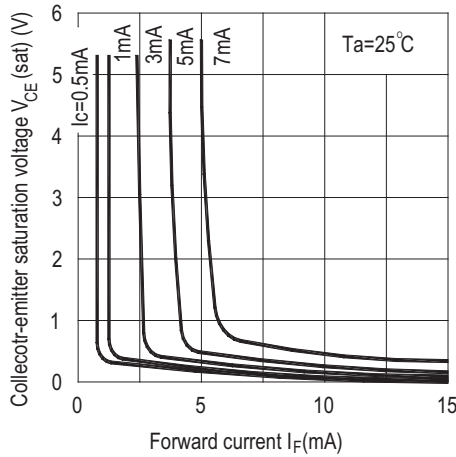
**Figure 1: Forward Current vs. Ambient Temperature**



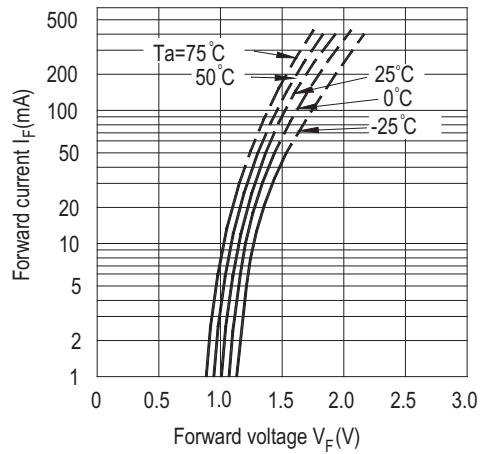
**Figure 2: Collector Power Dissipation vs. Ambient Temperature**



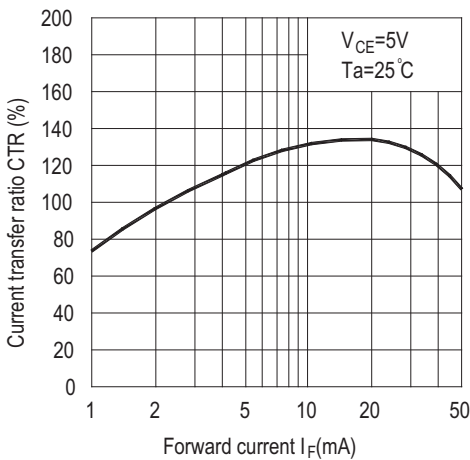
**Figure 3: Collector-Emitter Saturation Voltage vs. Forward Current**



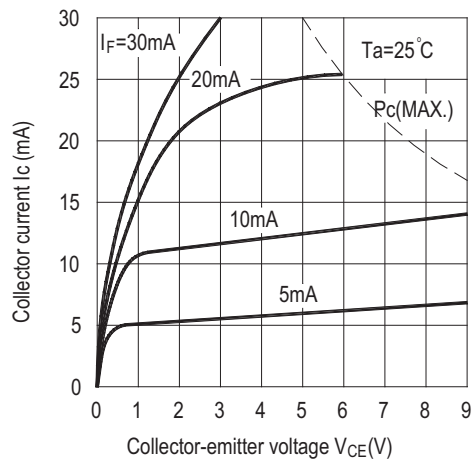
**Figure 4: Forward Current vs. Forward Voltage**



**Figure 5: Current Transfer Ratio vs. Forward Current**

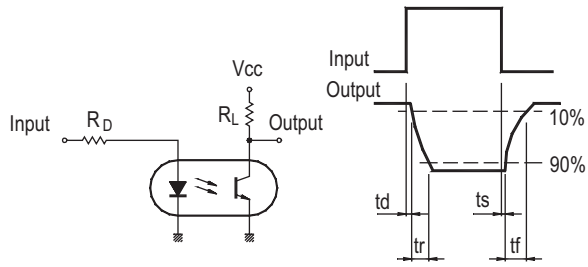


**Figure 6: Collector Current vs. Collector-Emitter Voltage**





**Figure 12: Test Circuit for Response Time**



**Figure 13: Test Circuit for Frequency Response**

